

Grab 1

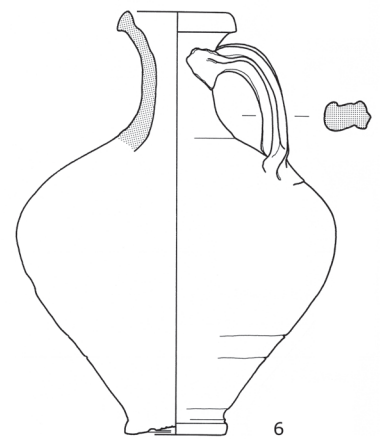

Grab 2

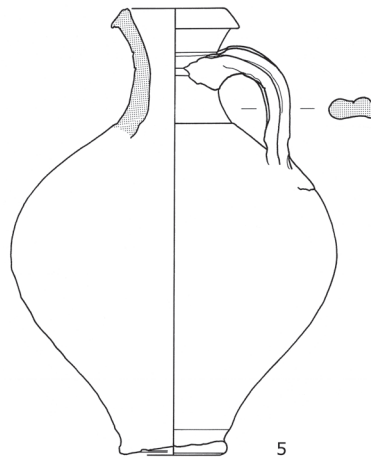
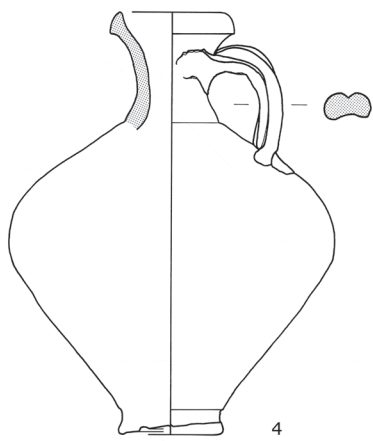
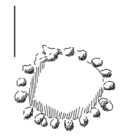
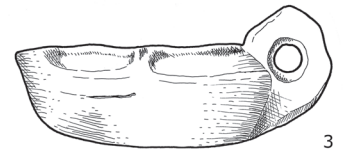
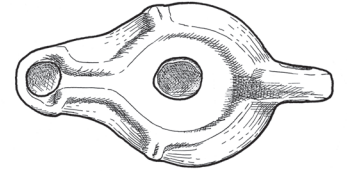
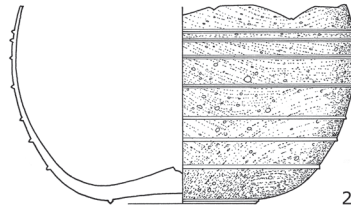
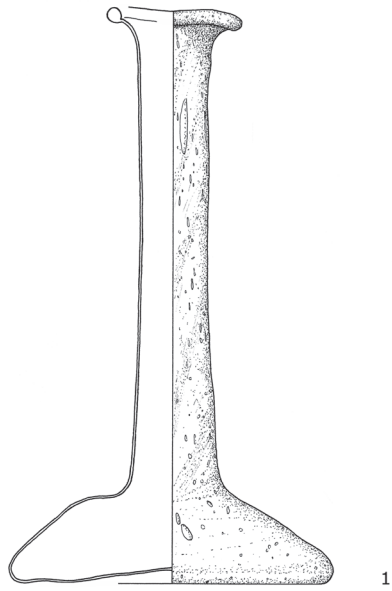

Grab 3

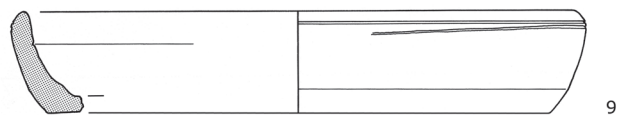
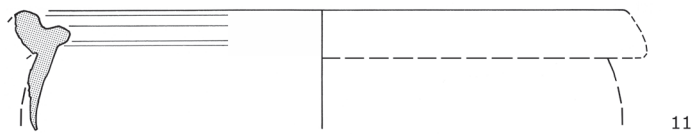

←
Grab 3

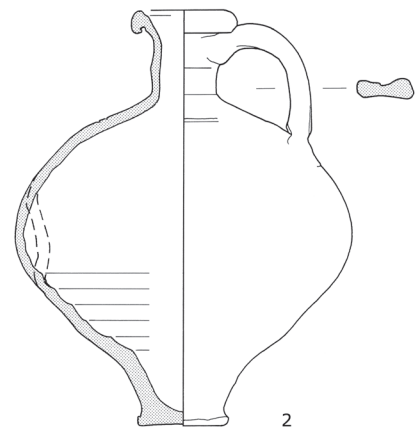
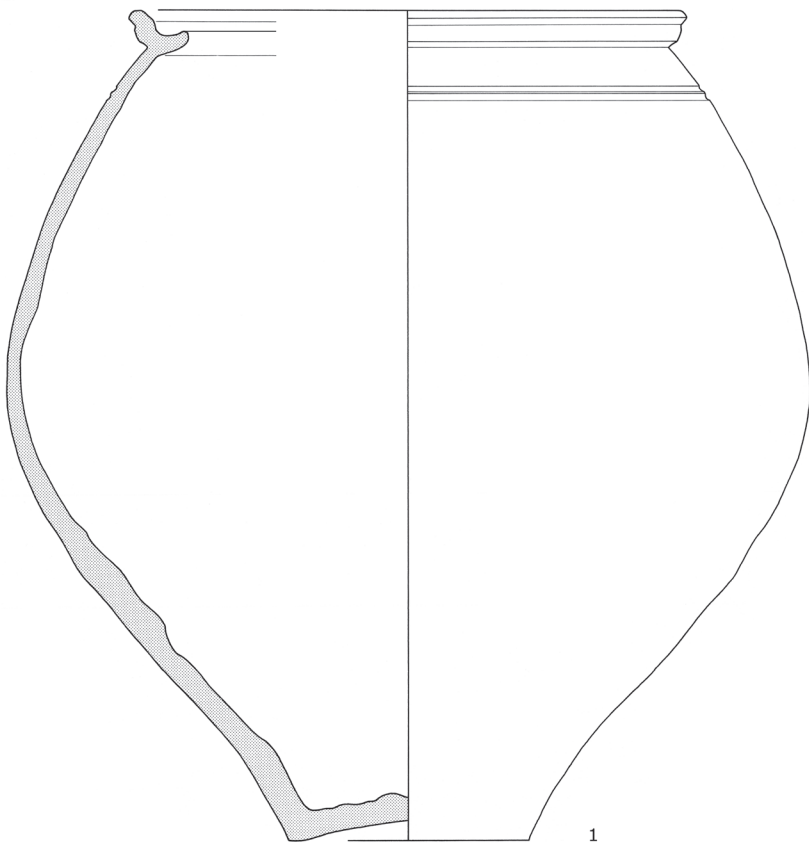
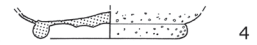
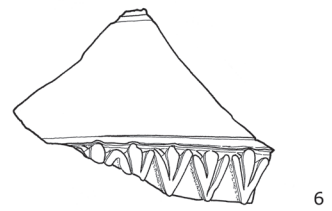
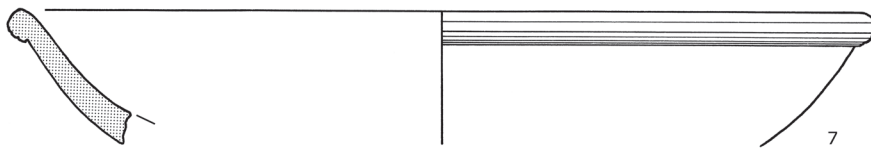
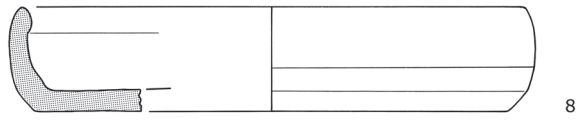
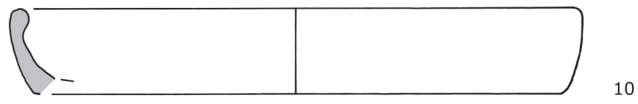

Grab 4

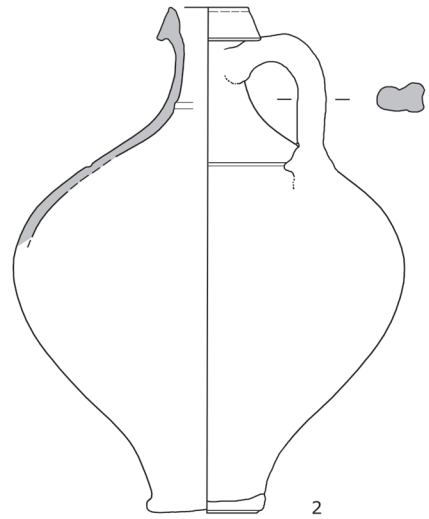
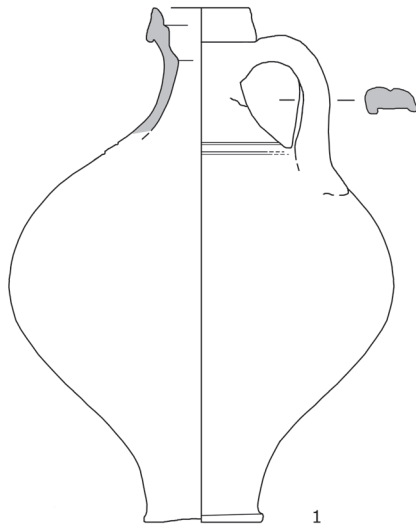

Grab 5



Glas

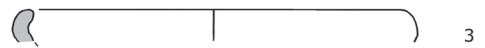
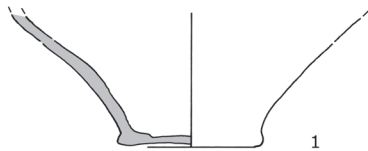

Grab 6



Glas
Nägel

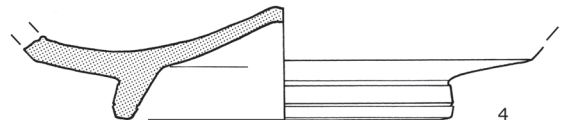
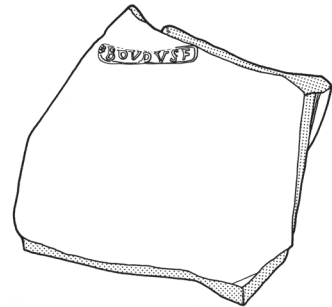
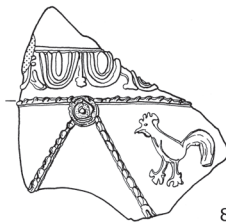
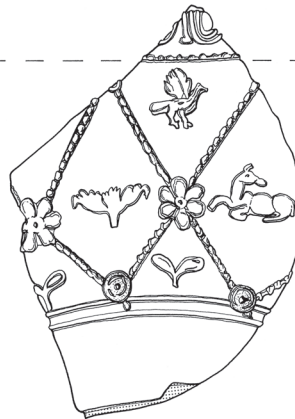
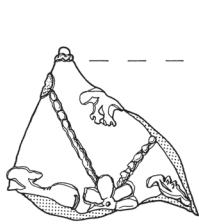

Grab 7



Nägel
Keramik

Grab 8



Nägel

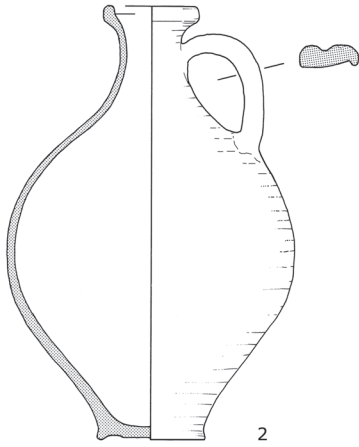

2

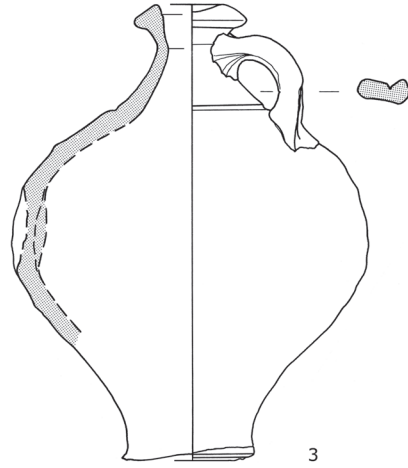

3

Grab 9

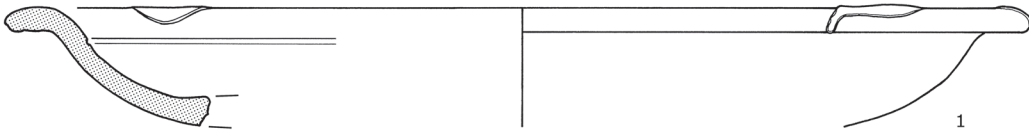
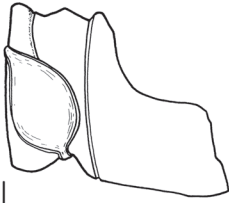

1

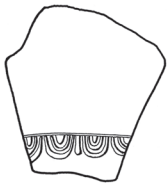

3

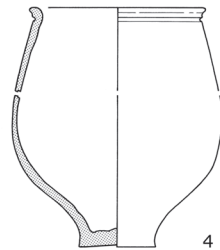

4

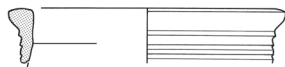

7

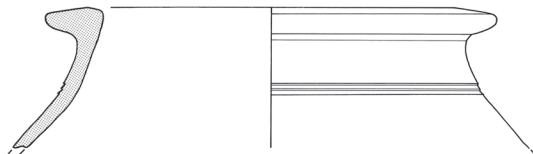

8

Fundstelle 9 A



Ziegel

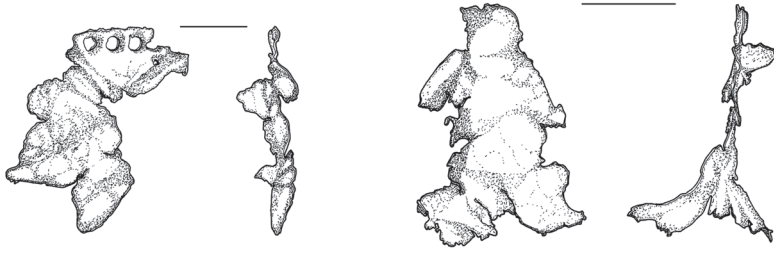

10

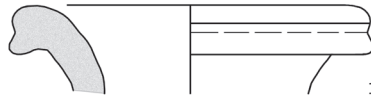

14



16

Grab 10



Nägel
Keramik



Grab 11

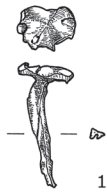

1

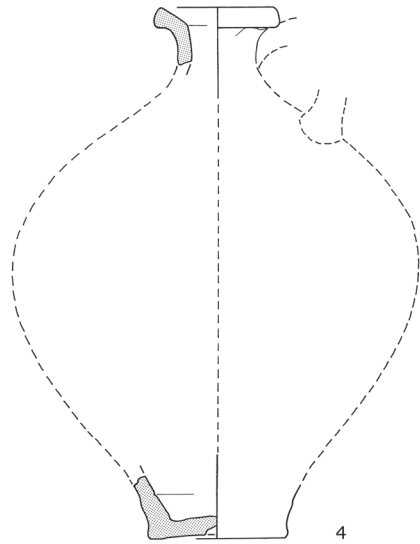

4

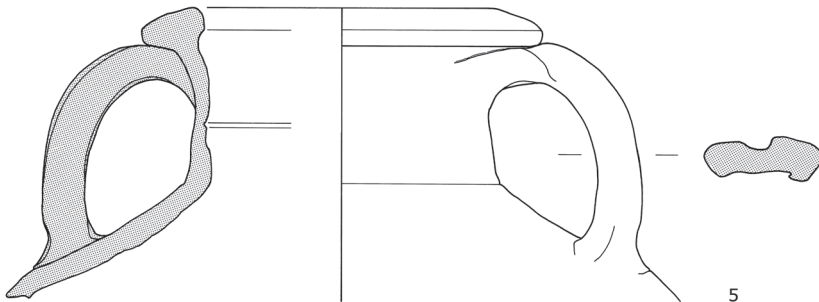

5

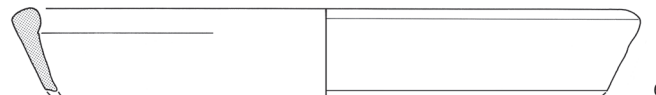

6

Grab 12

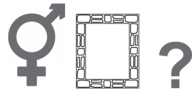

 Nägel
Glas
Stein

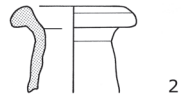

2

Grab 13



Grab 14



 Nägel
Sandstein

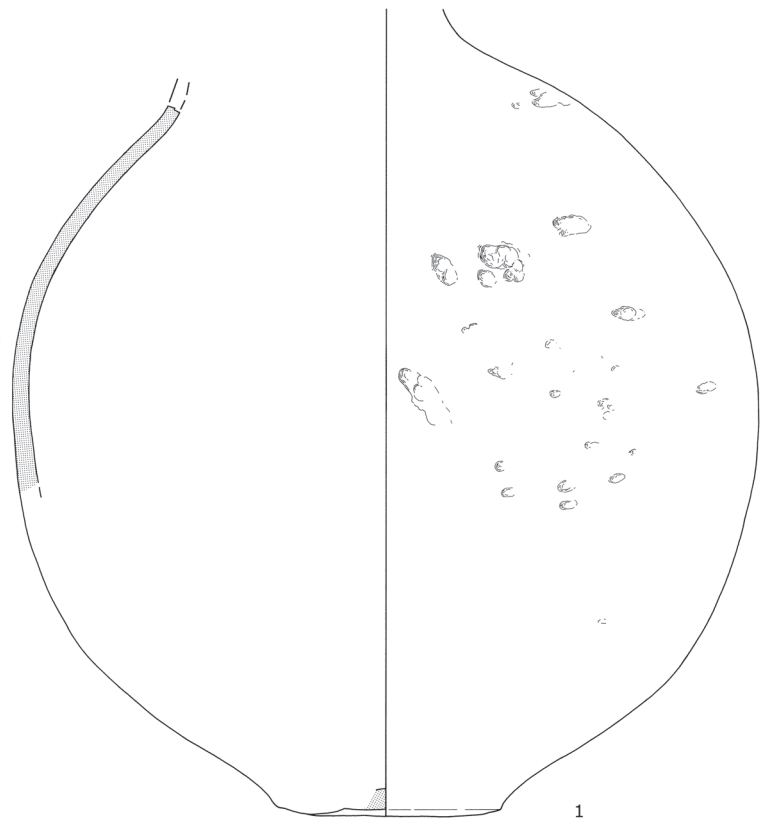
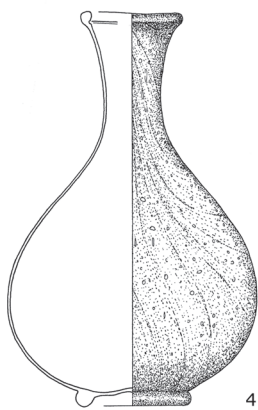
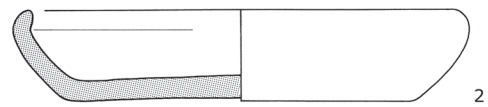
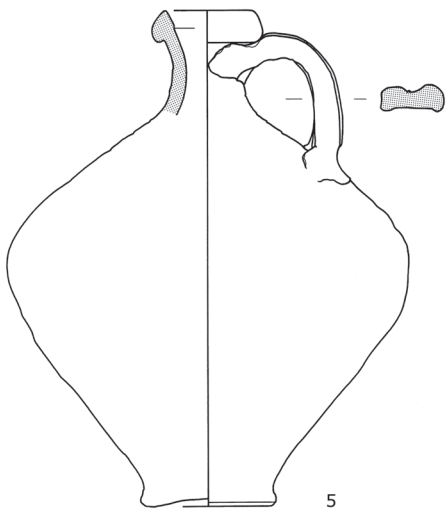

Grab 15 A



Nägel

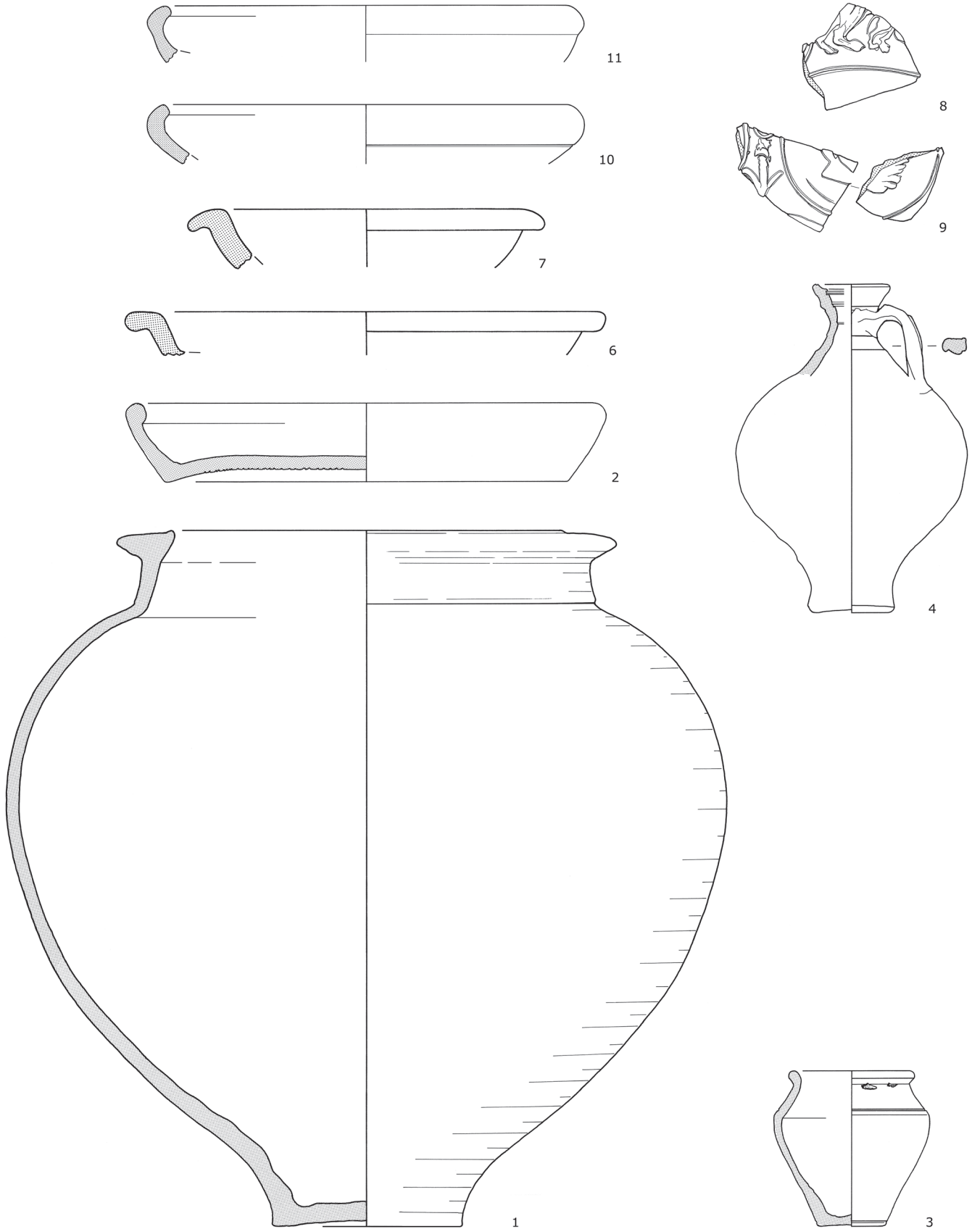

Grab 15 B

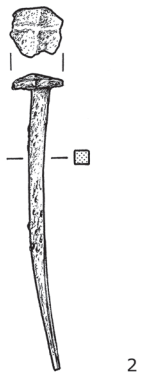
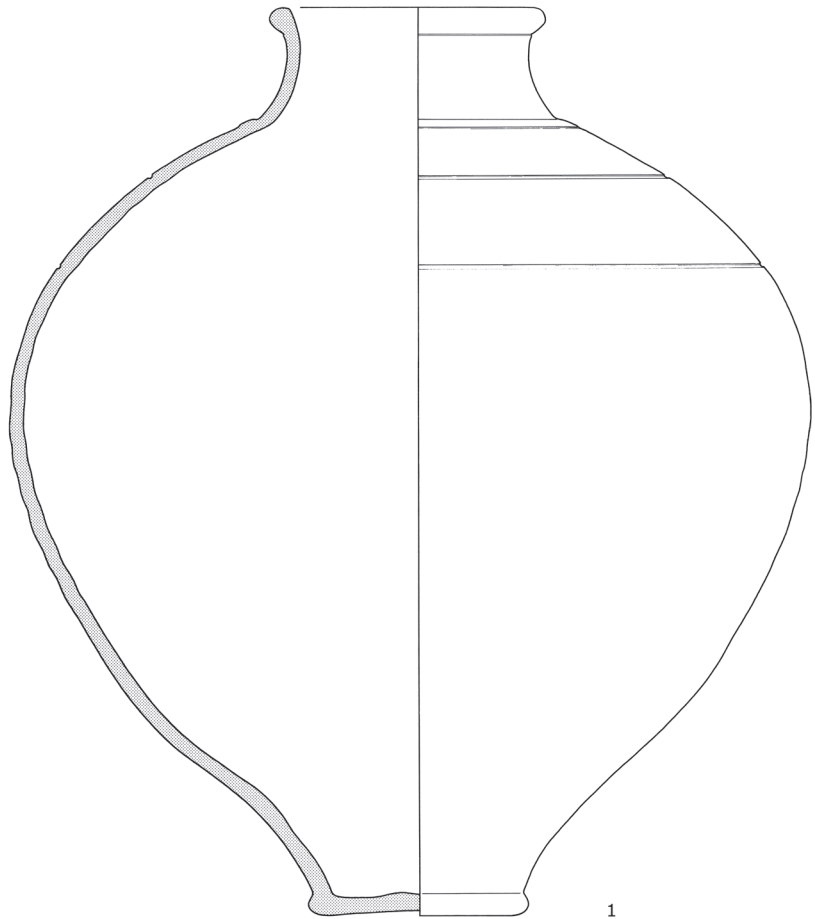
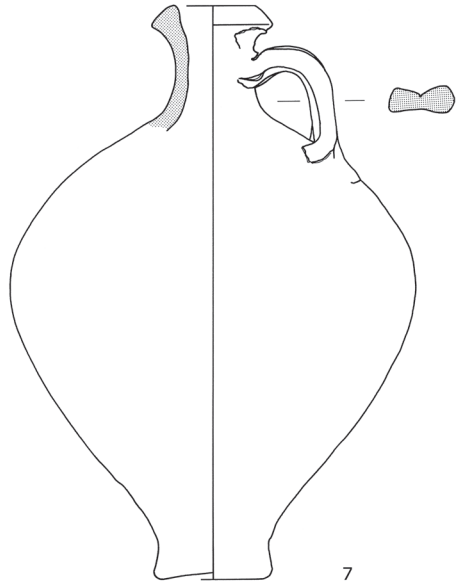
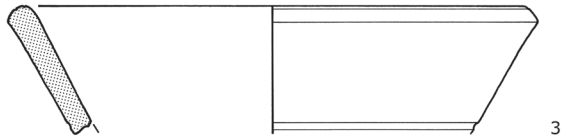
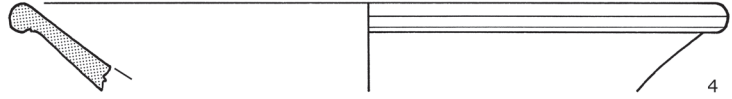
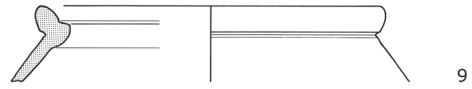

Grab 16



Keramik

Grab 17



Glas
Nägel

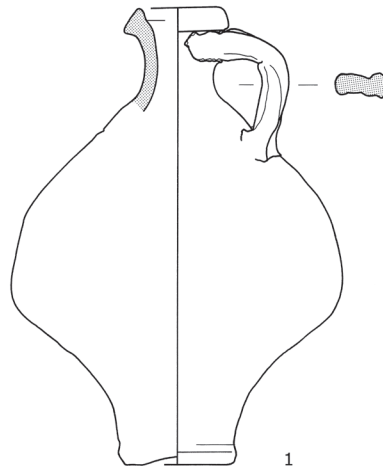

Grab 18

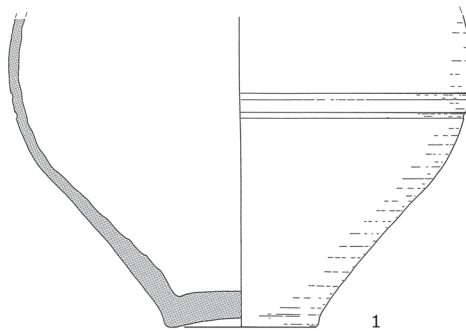
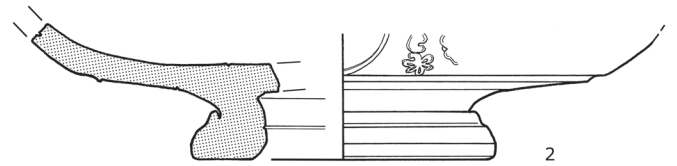
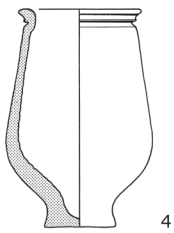
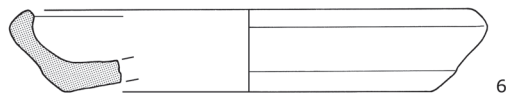

Grab 19



Grab 20

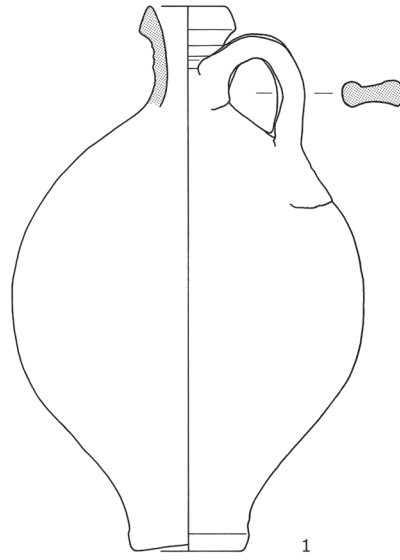

Grab 21



Glas
Nägel
Schuhnagel

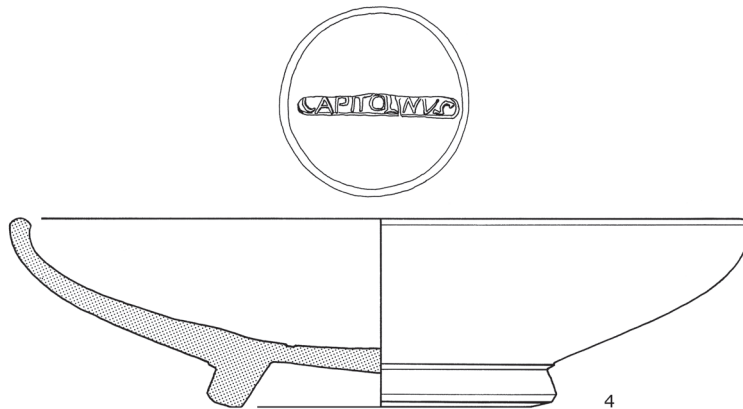
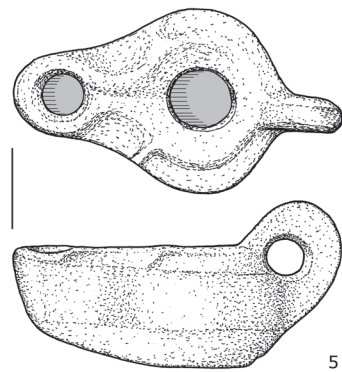
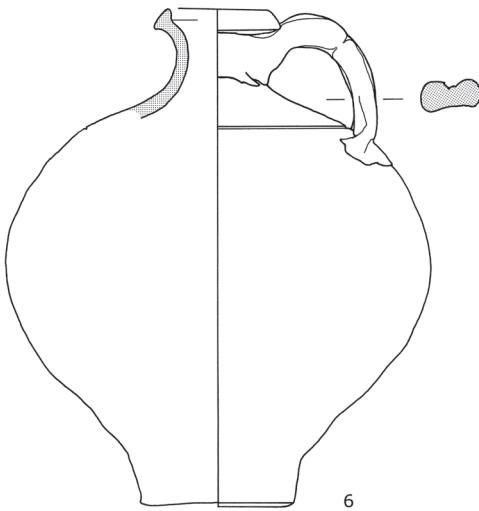

←
Grab 21

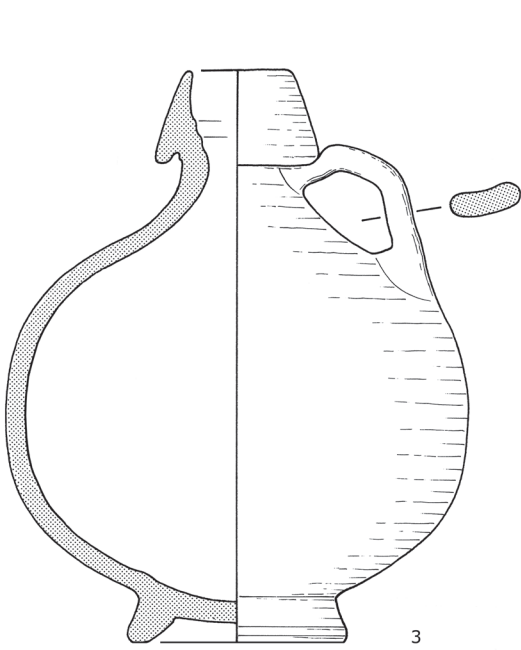

3

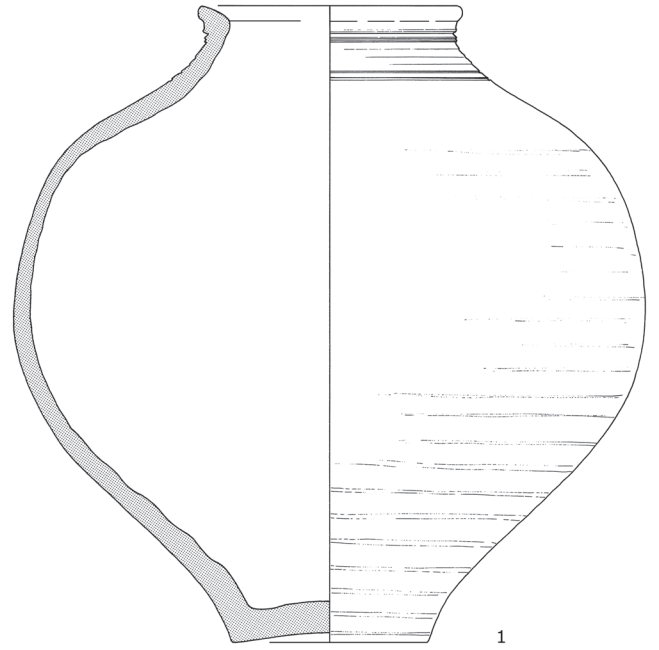

1

Grab 22

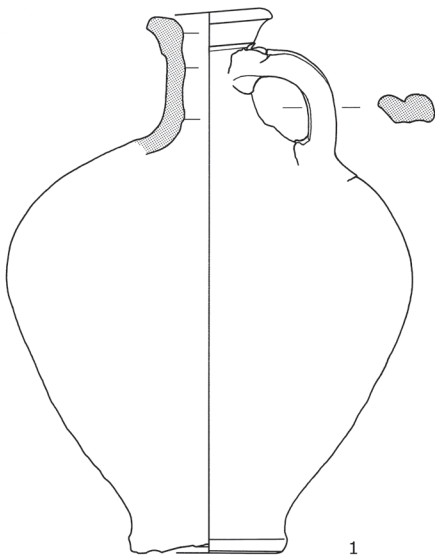

1

Grab 23



Nagel

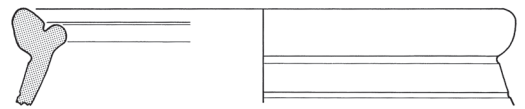

6

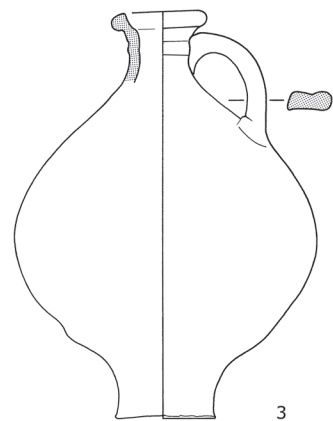

3

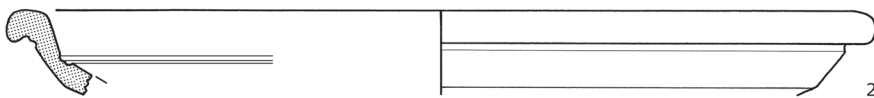

2



4

Grab 24



Nagel

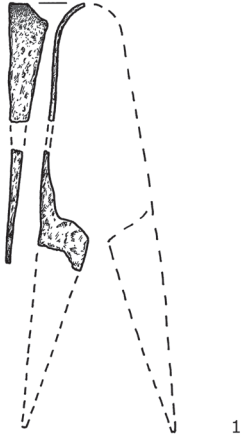

1

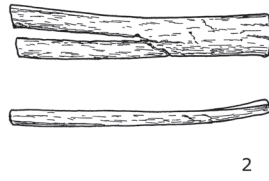

2

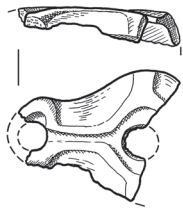

3

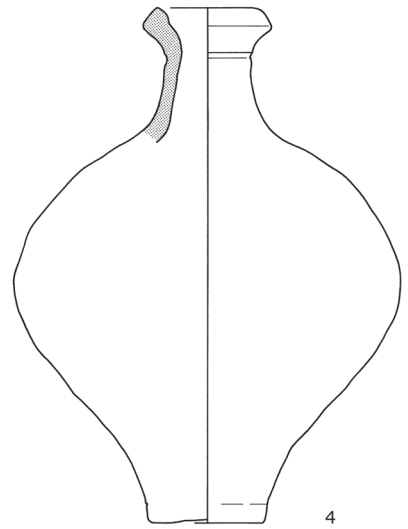

4

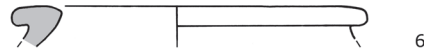

6

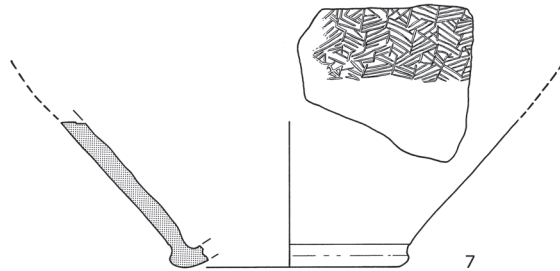

7

Grab 25



Nagel

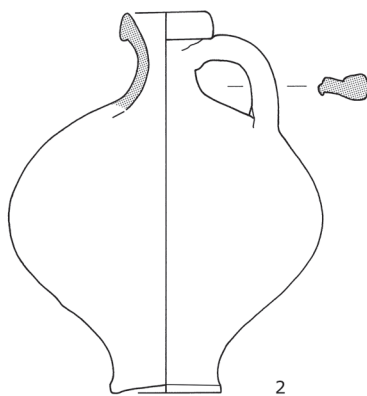

2

Grab 26



Nagel

Antoninus
Pius
138-161 n.Chr.
Dup.

1

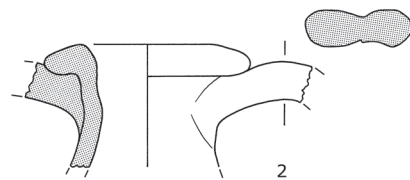

2

Grab 27



Schere

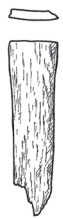

1



2

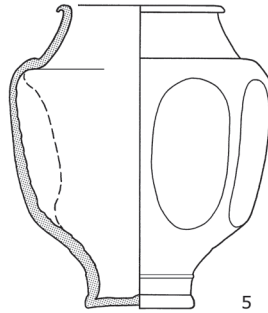

5

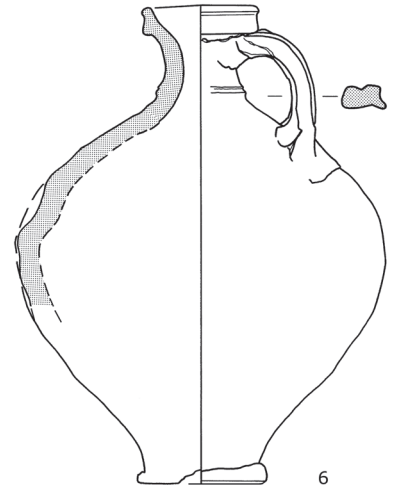

6

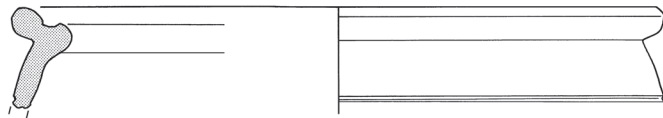

7

Grab 28



Nägel



Grab 29

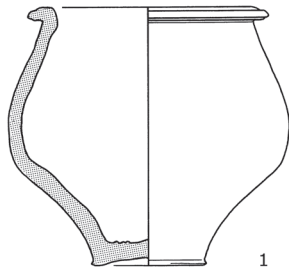

1

Grab 31



Grab 32



Grab 30



Nägel

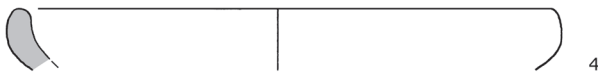

4

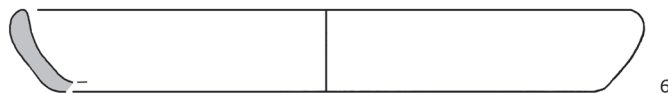

6



5

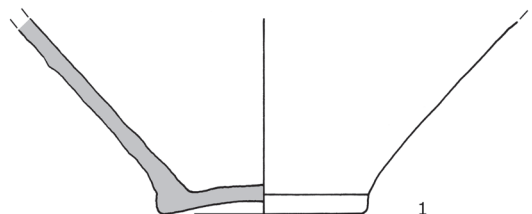

1

Grab 33

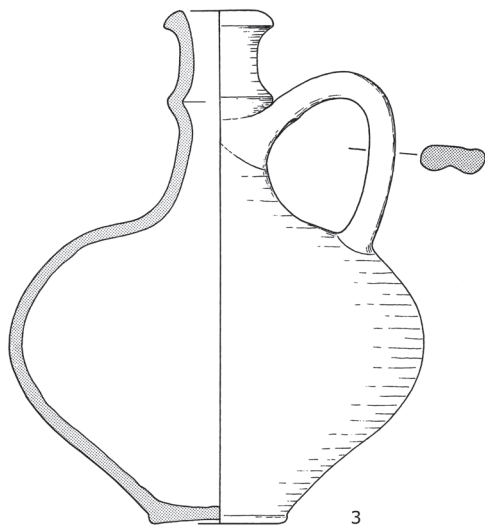
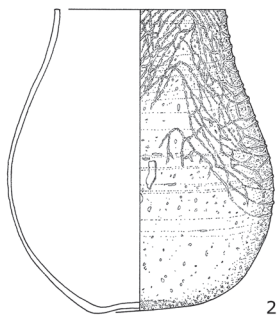
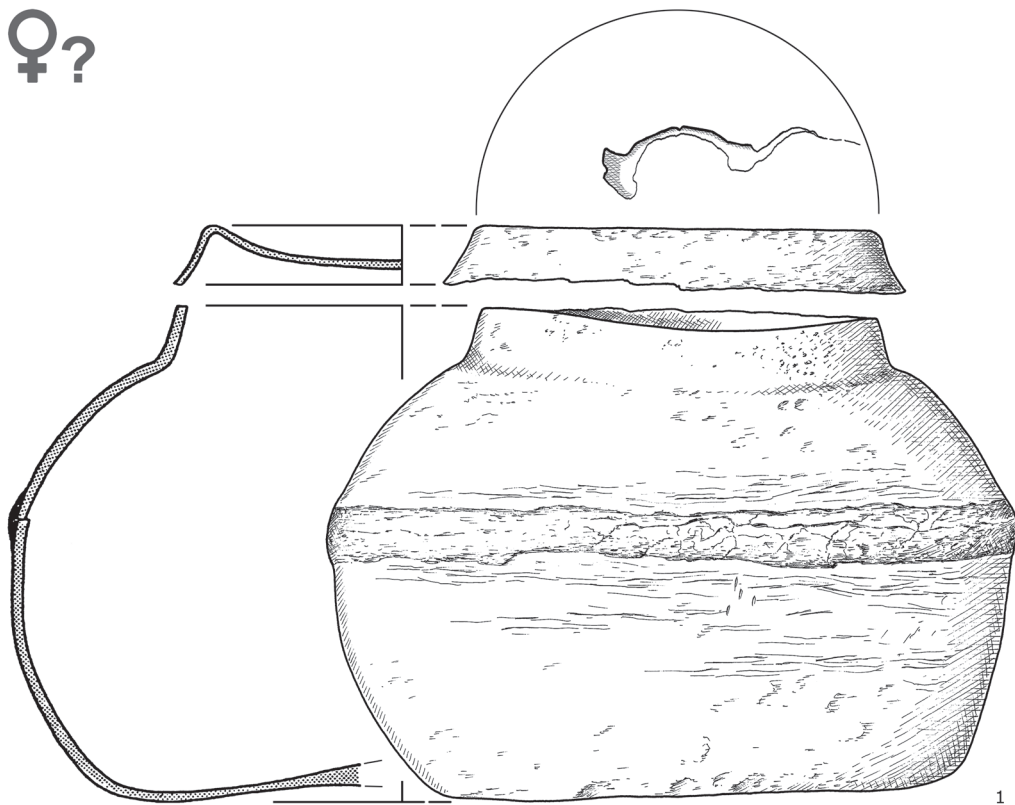

Grab 34

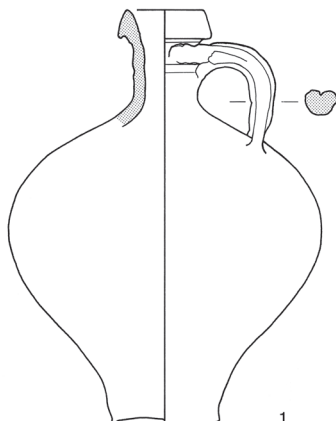

Grab 35

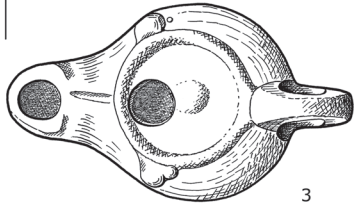
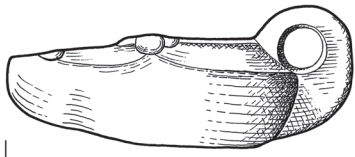

3



4

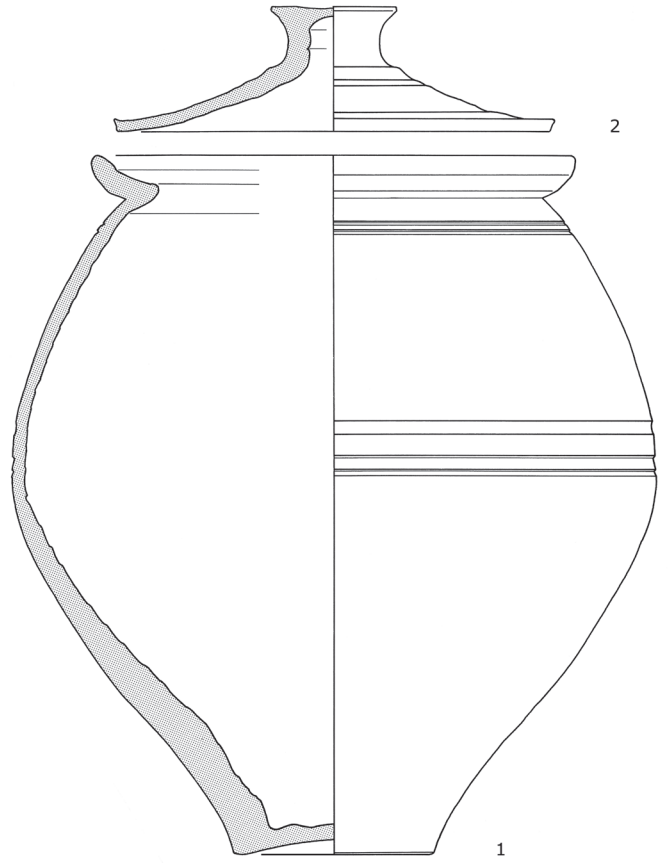

2

1

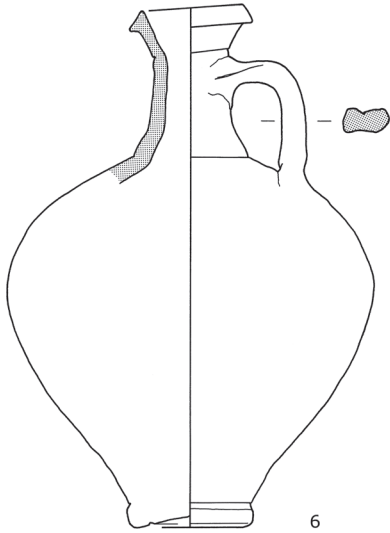

6

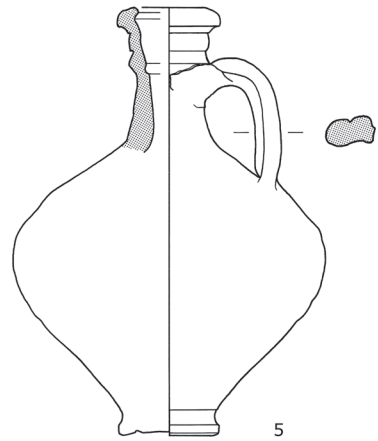

5

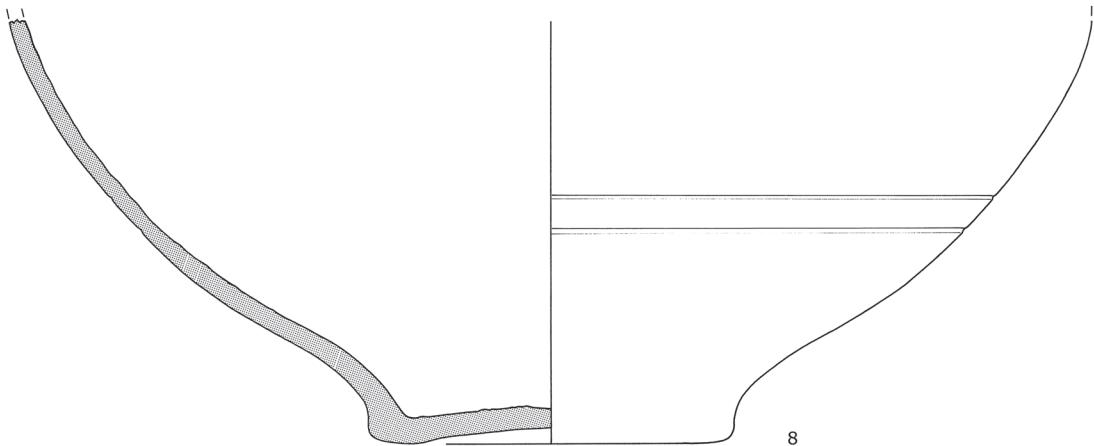

8

←
Grab 35



Ziegel

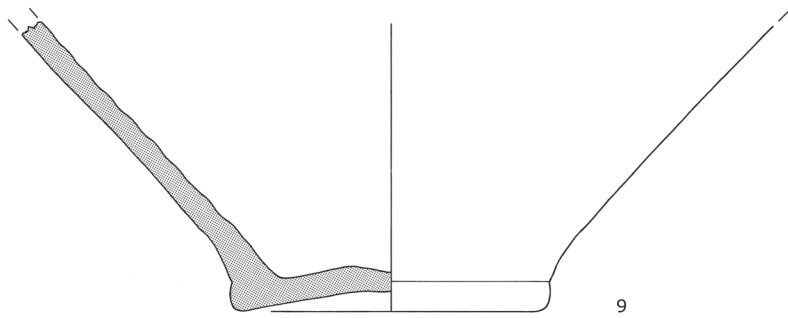

Fundstelle 36

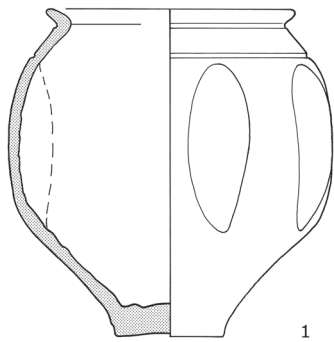

Grab 36 A



Grab 37 A

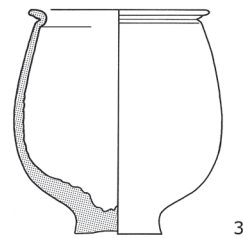
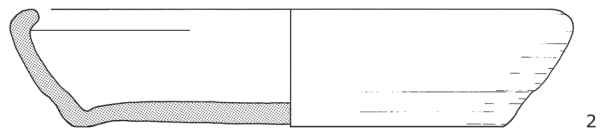
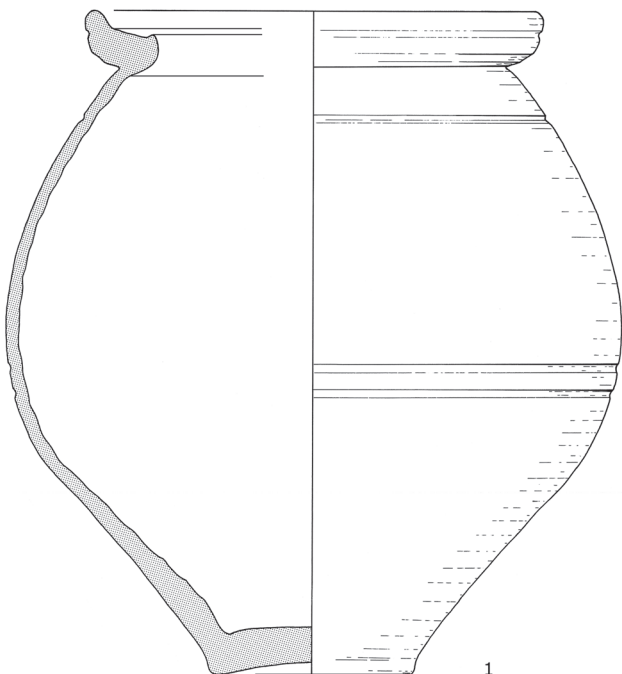

Grab 37 B



Schuhnagel
Bronze

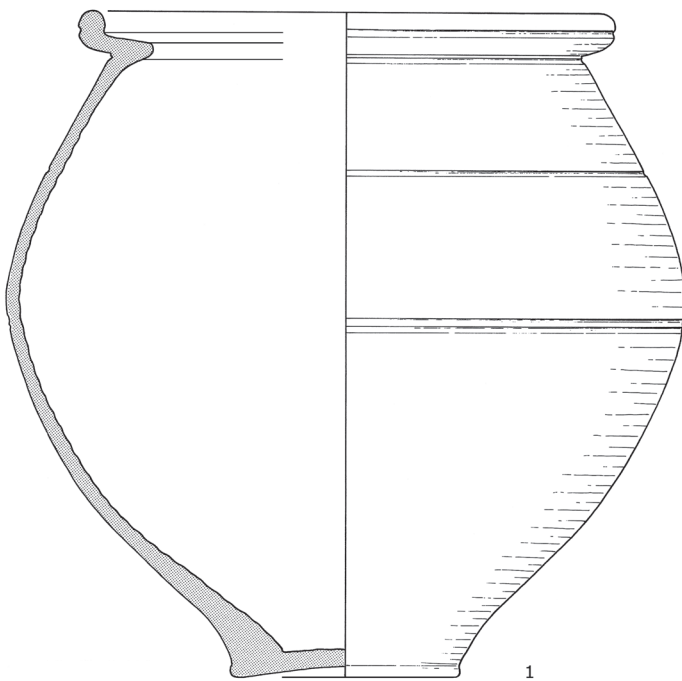
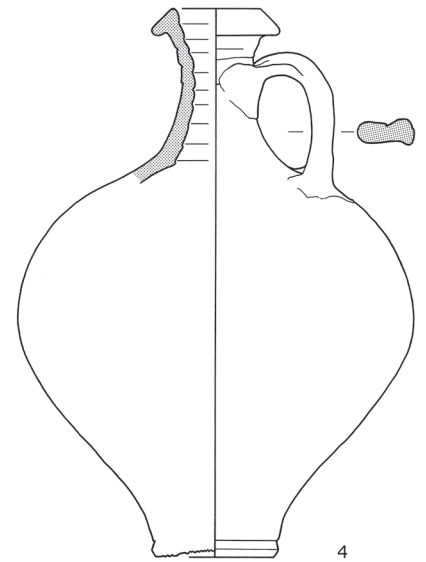
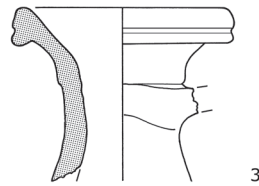
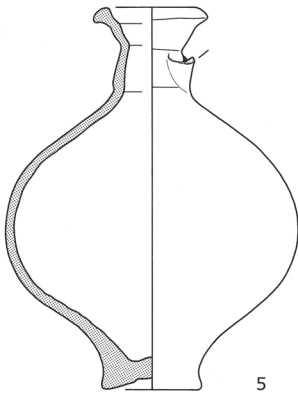
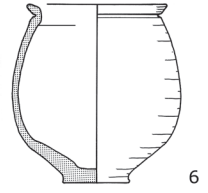
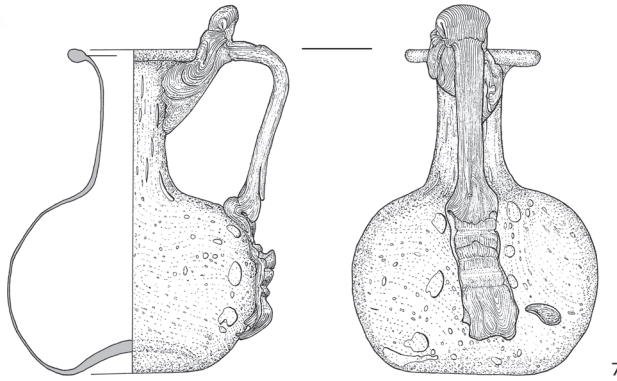

Zwischenbereich
37 A und 37 B



Nägel

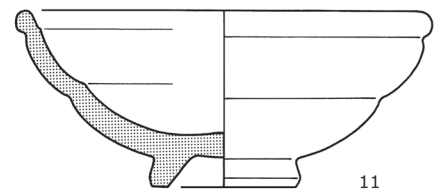
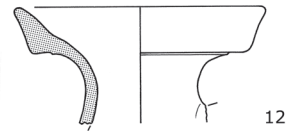

Grab 38



Nägel

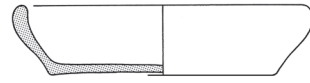
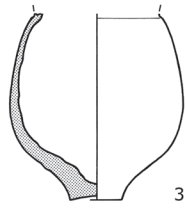

Grab 39



Glasschmelz

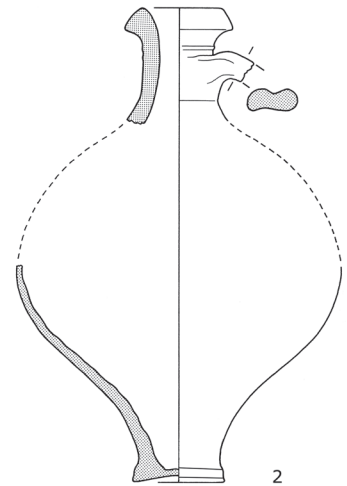
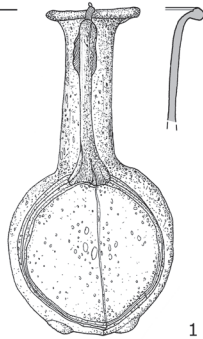
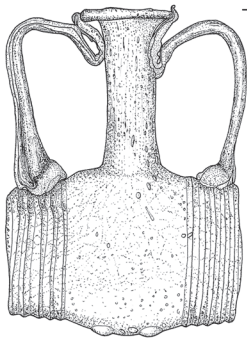
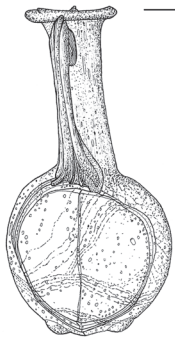
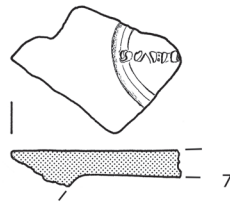
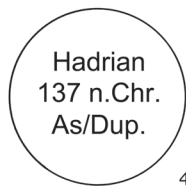

Grab 40



Nägel

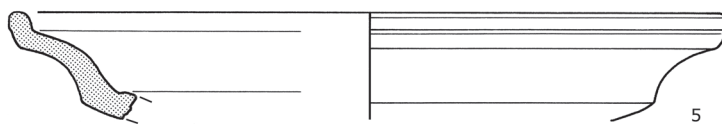
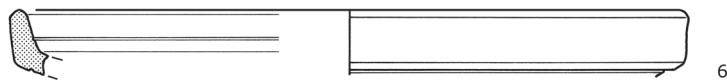
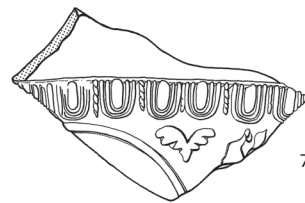
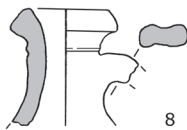

←
Grab 40

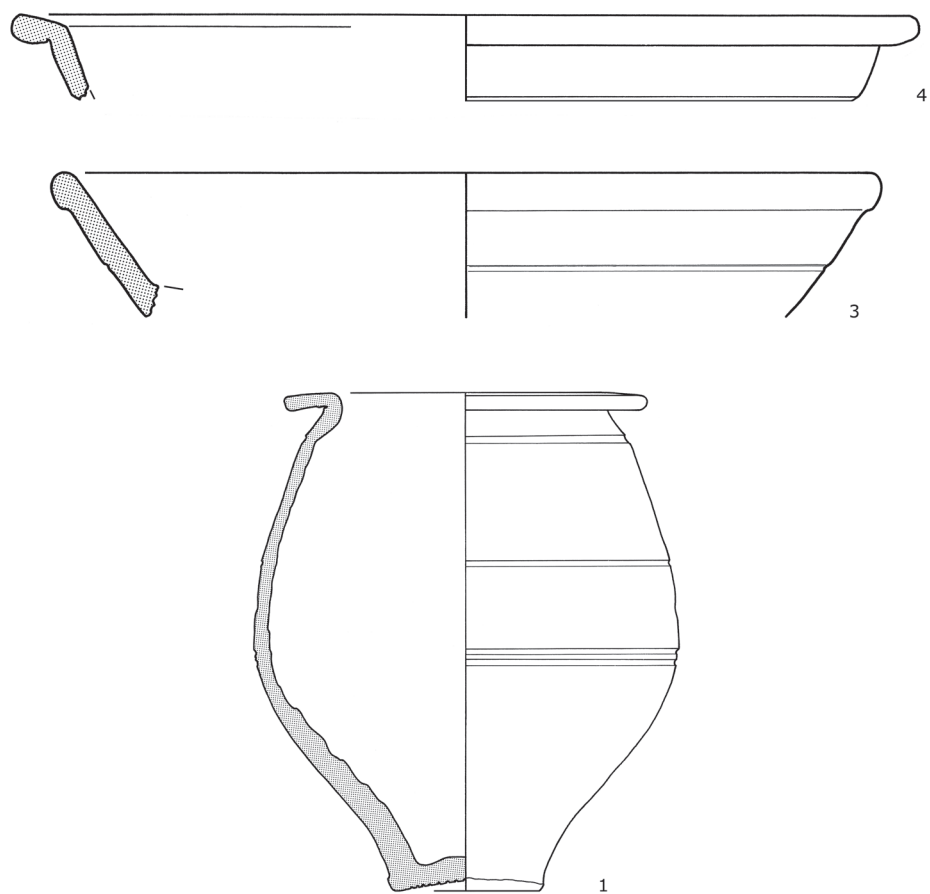

Grab 41

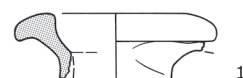

Grab 42

Domitian
As
84-96 n.Chr.

2

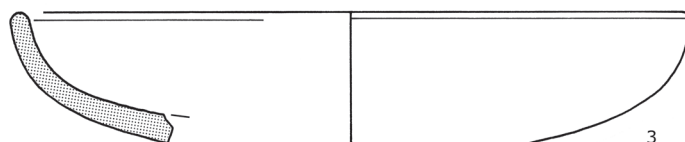
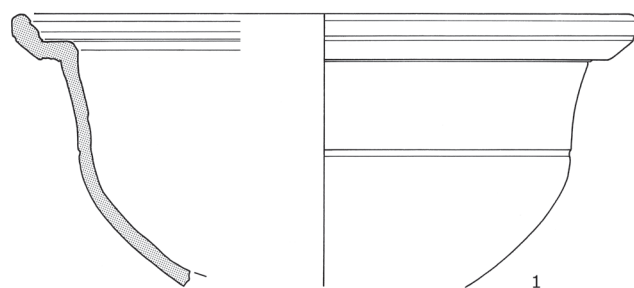

Grab 43



Nägel
Schuhnagel

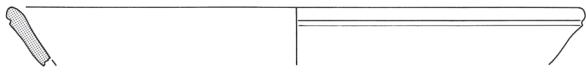

5

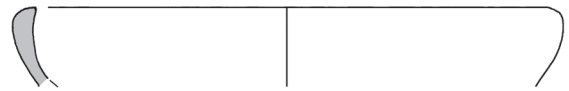

6

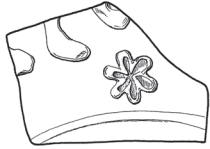

4

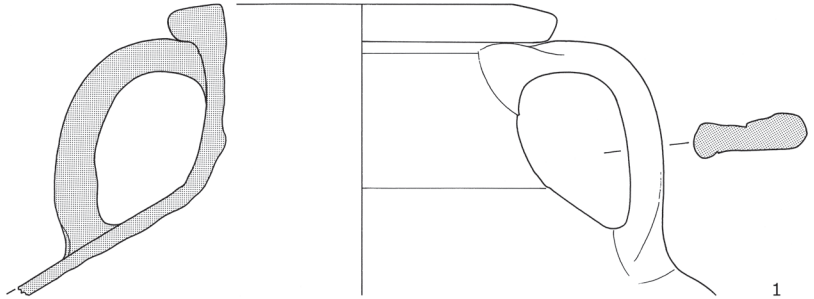

1

Grab 44



Nägel
Bronzeblech



3



5

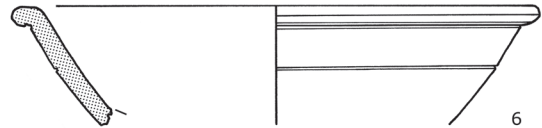

6

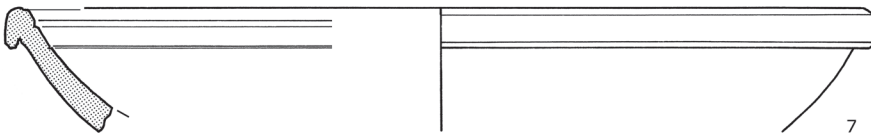

7

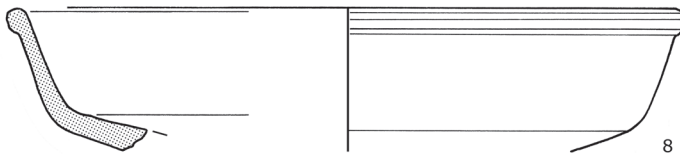

8

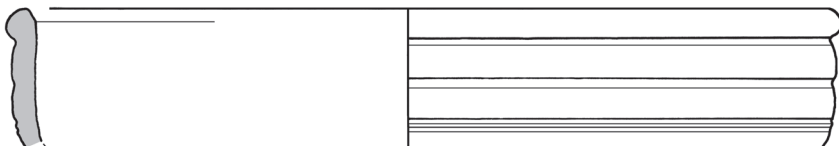

11

←
Grab 44

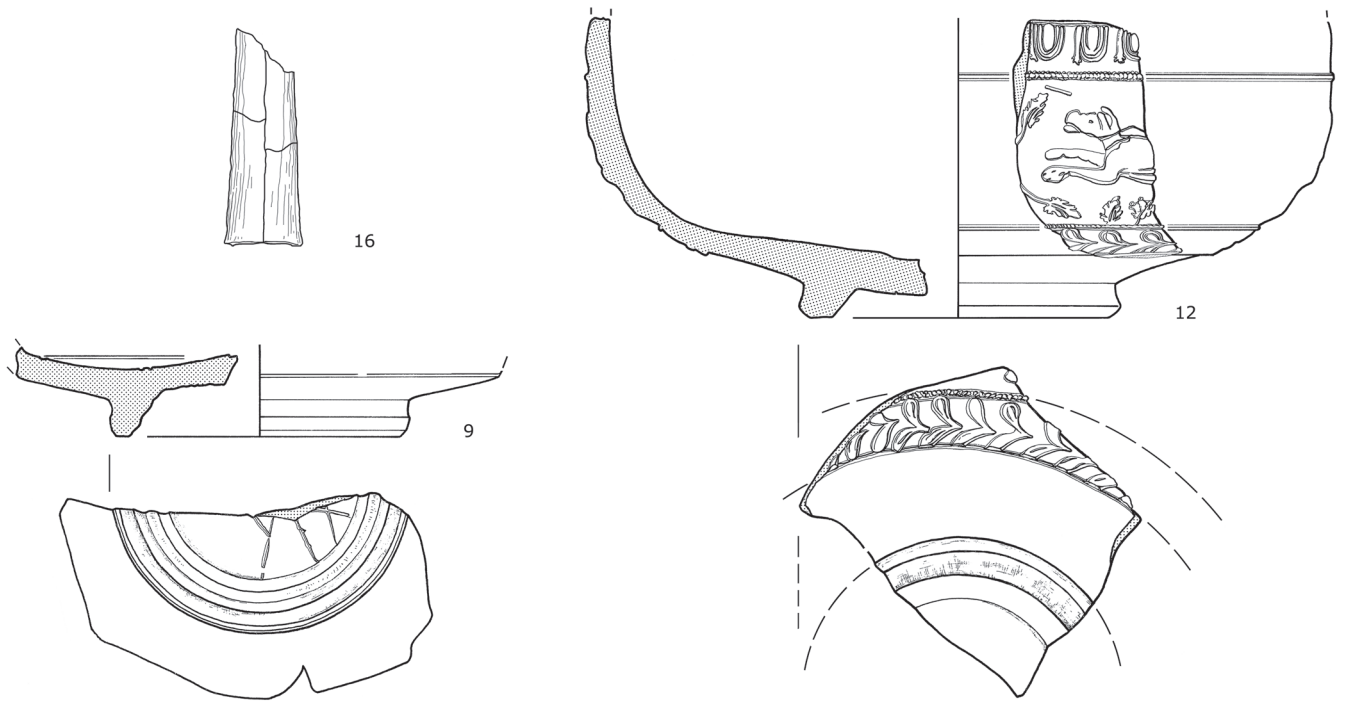

Grab 45



Nägel
Fibelspirale

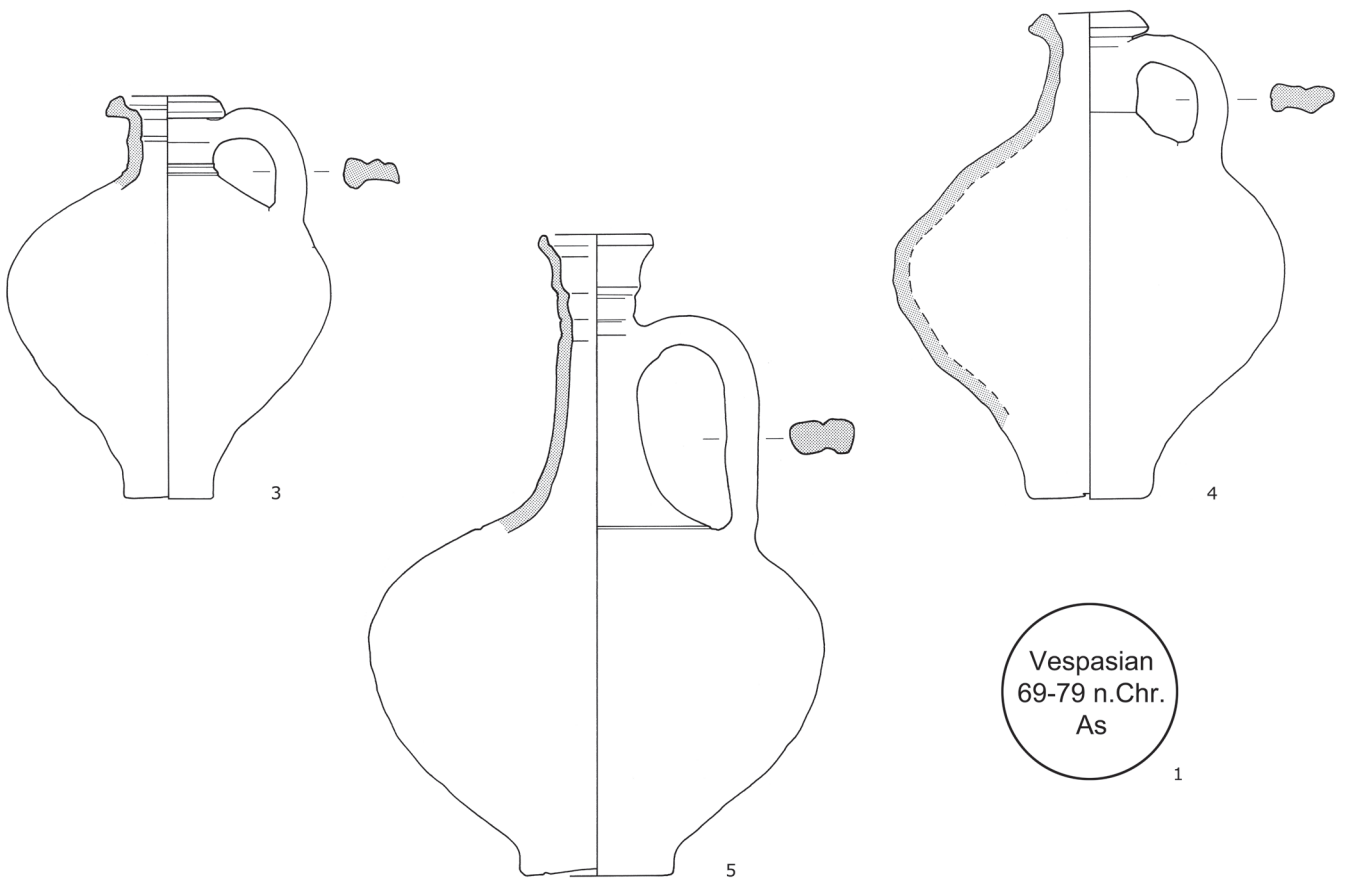

Grab 46

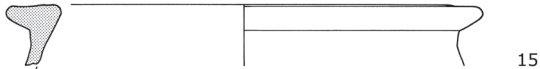
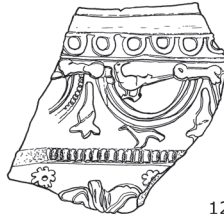
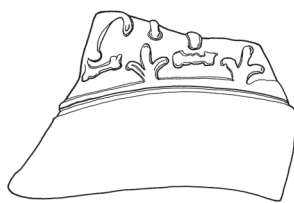
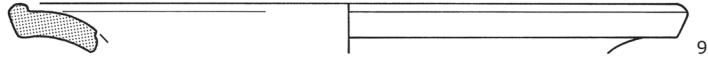
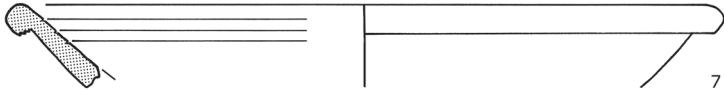
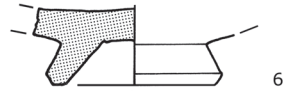
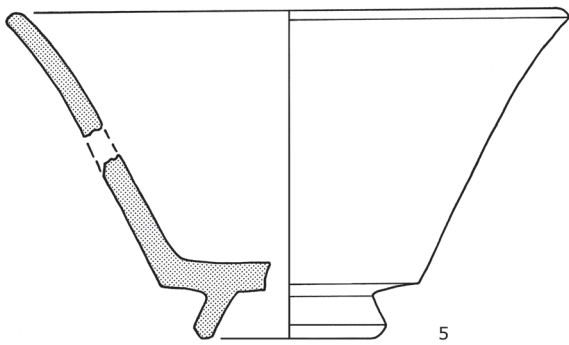
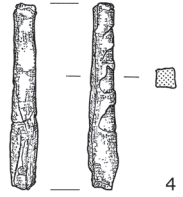
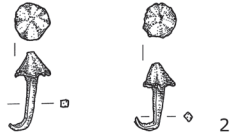
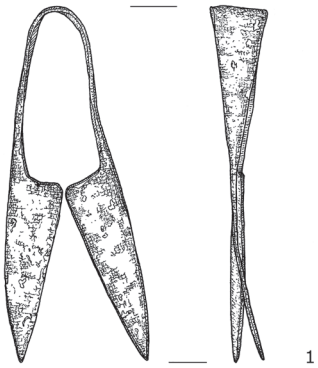

10

11

12

13

15

16

Grab 47

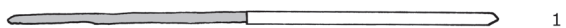

Grab 48



Nadel

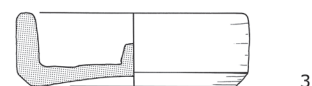
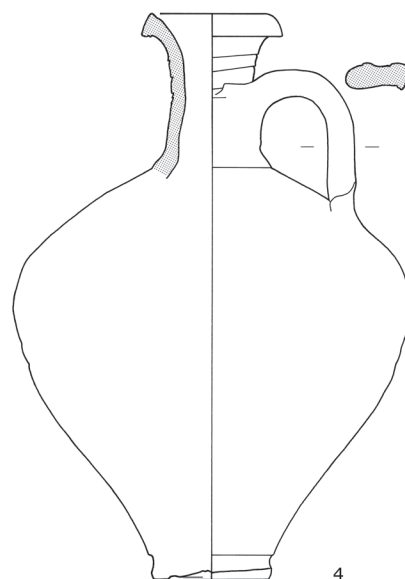
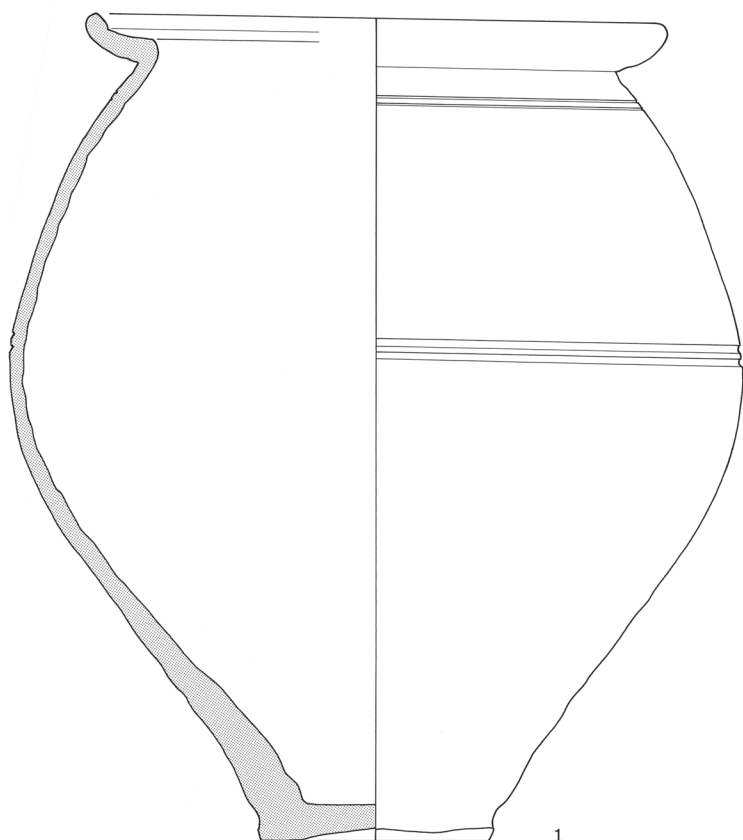
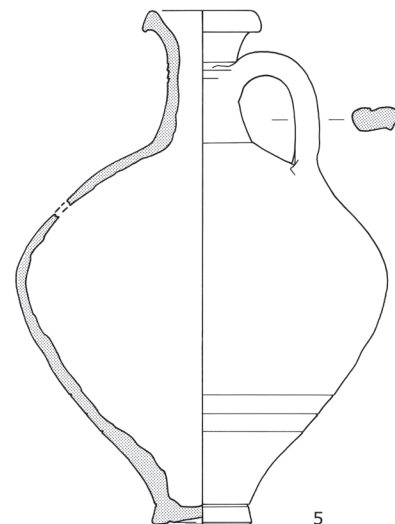
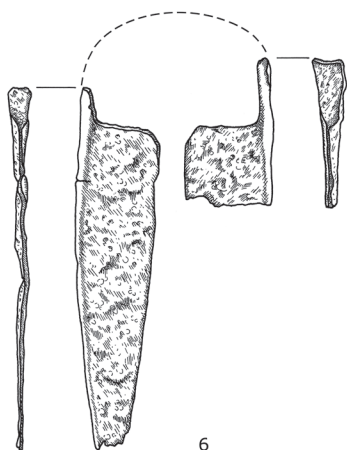

Grab 49

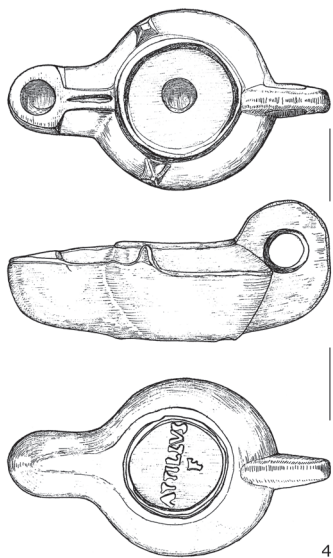

4

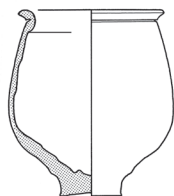

5



3

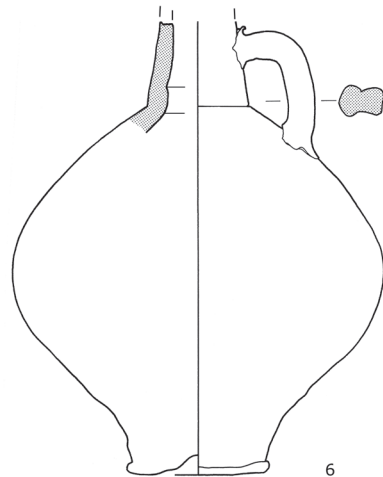

6

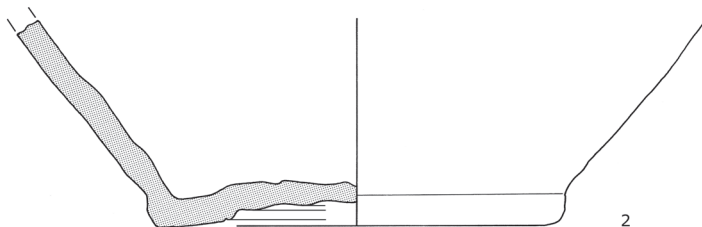

2

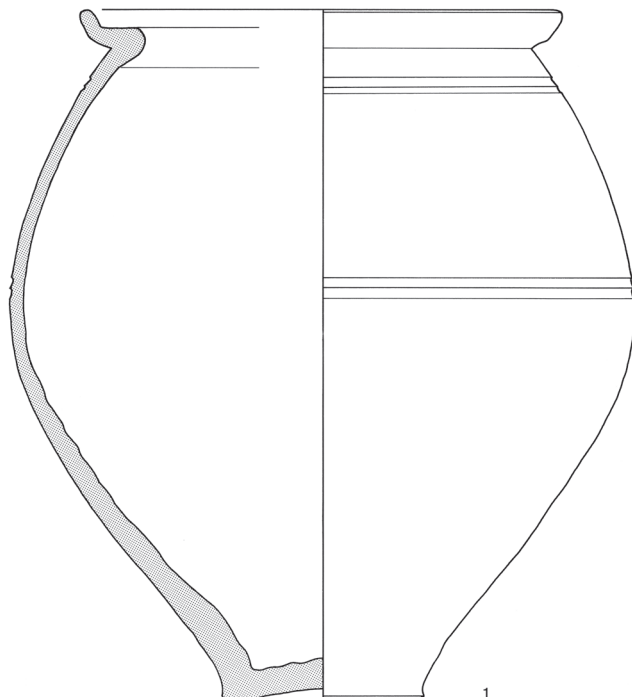

1

Grab 50



Nagel
Beschlag

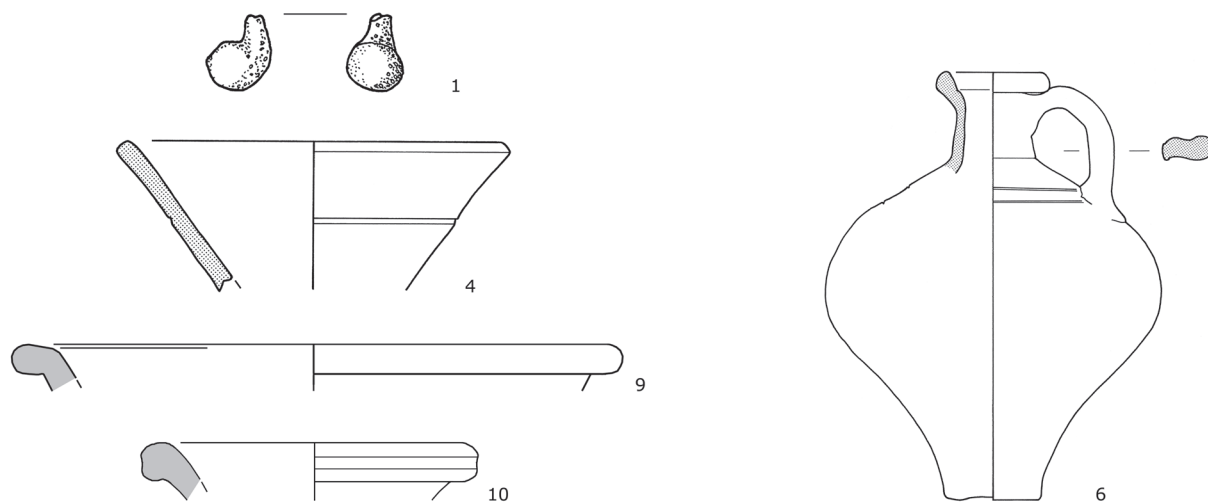

Fundstelle 51



Nägel
Schuhnagel
Ziegel

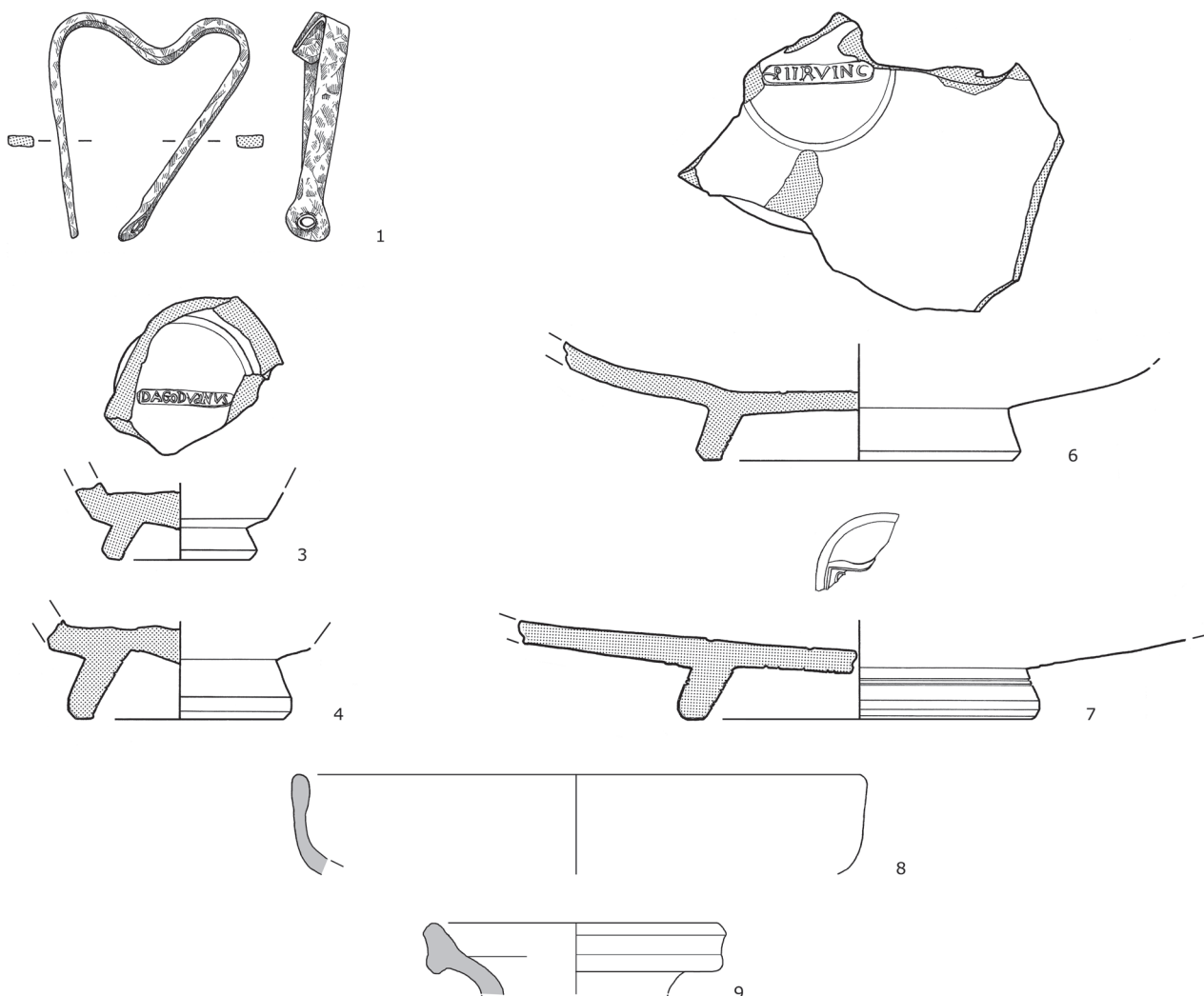

Grab 52



Nägel

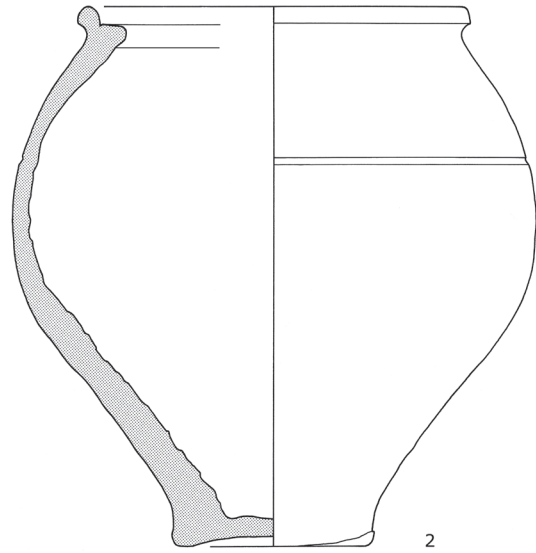
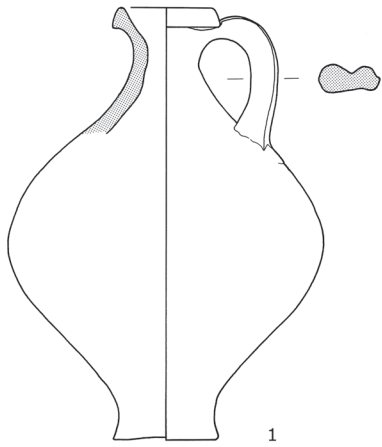
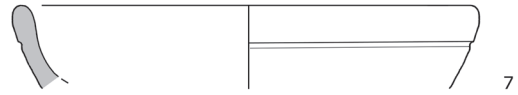
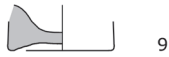

Grab 53



Nägel

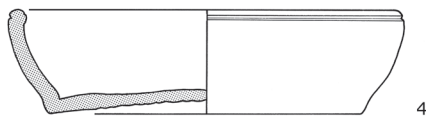
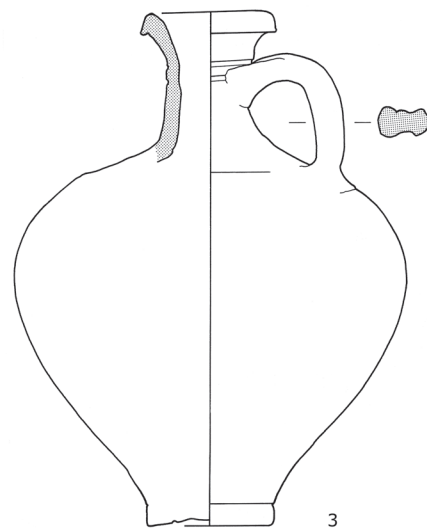
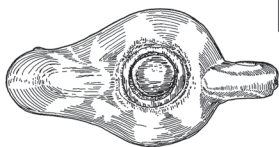
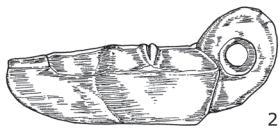
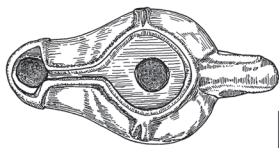

Grab 54



Bronzedraht

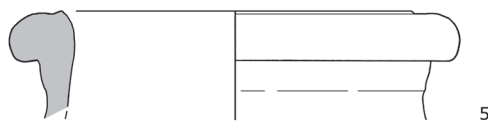
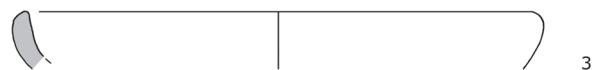
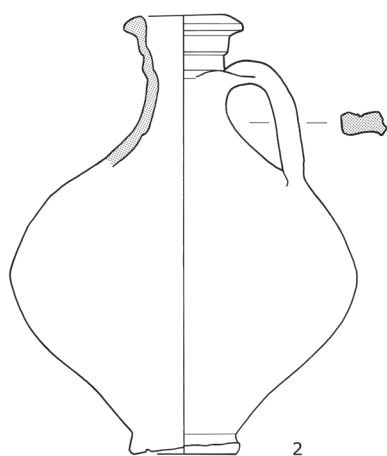

Glas

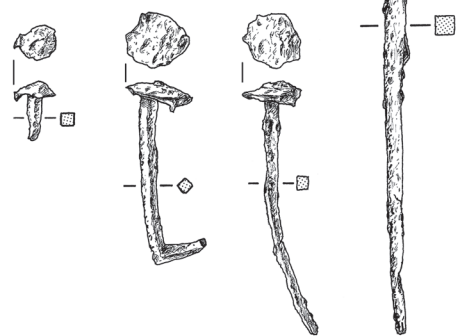

Grab 55

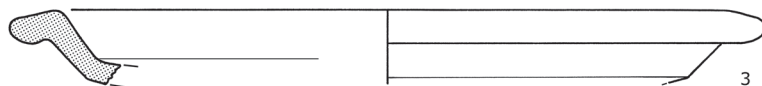

Grab 56

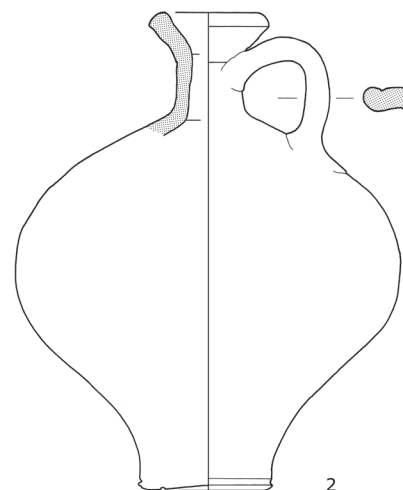
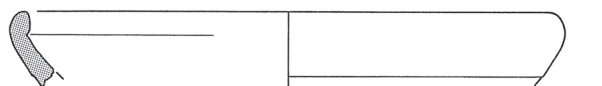
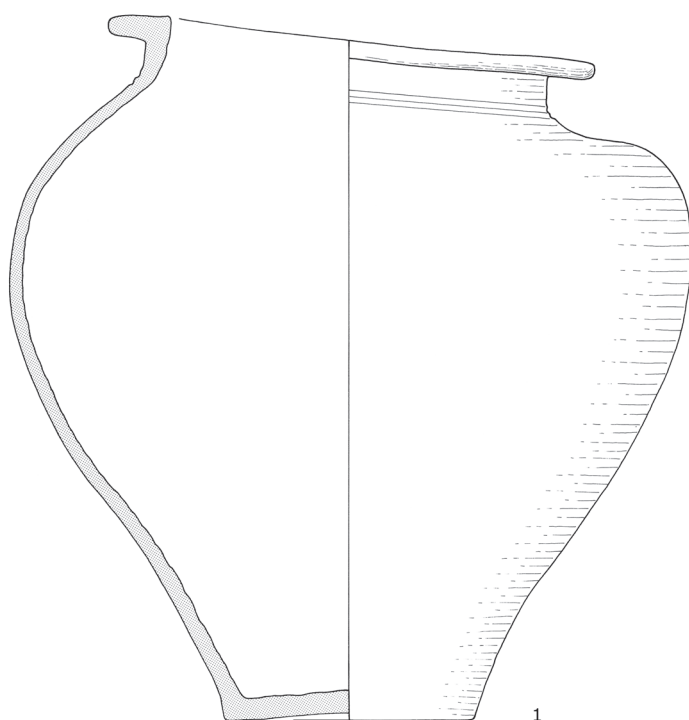

Grab 57

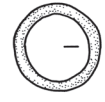

6

5

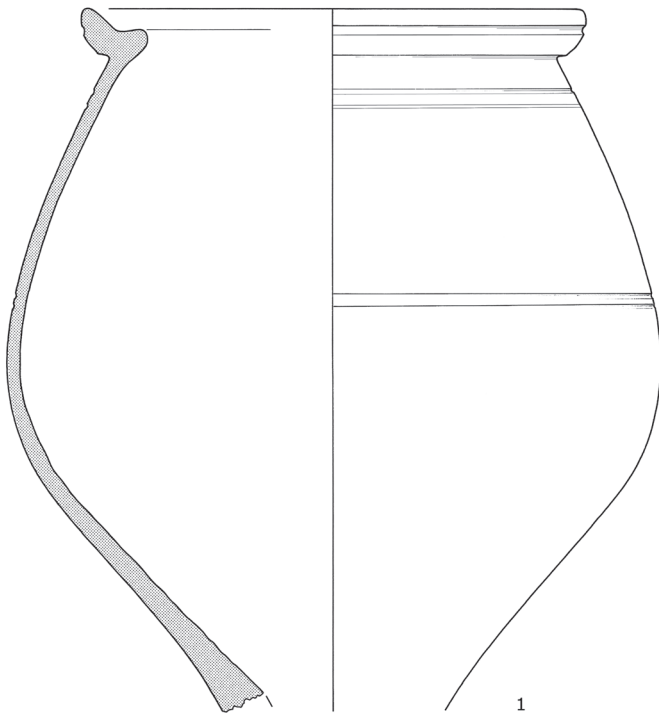

1

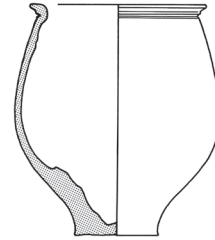

9

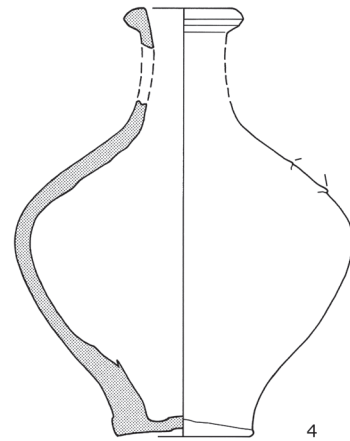

4

Grab 58

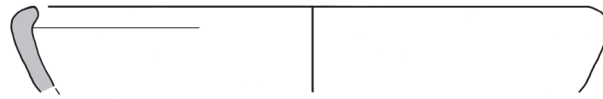

10

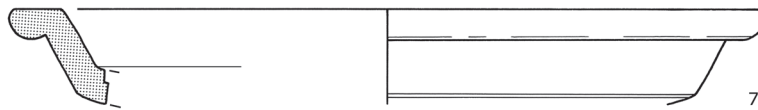

7

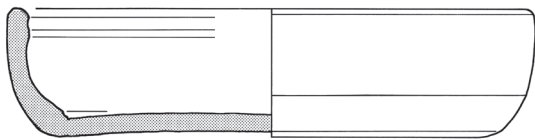

3

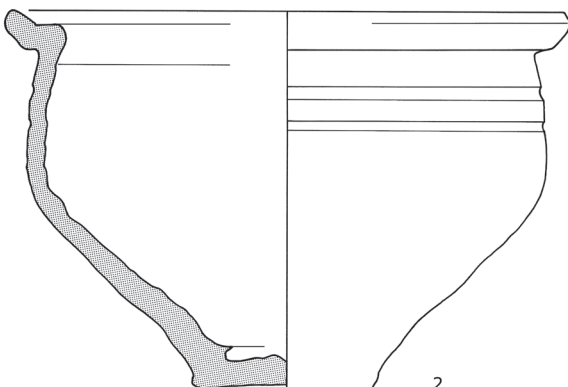

2

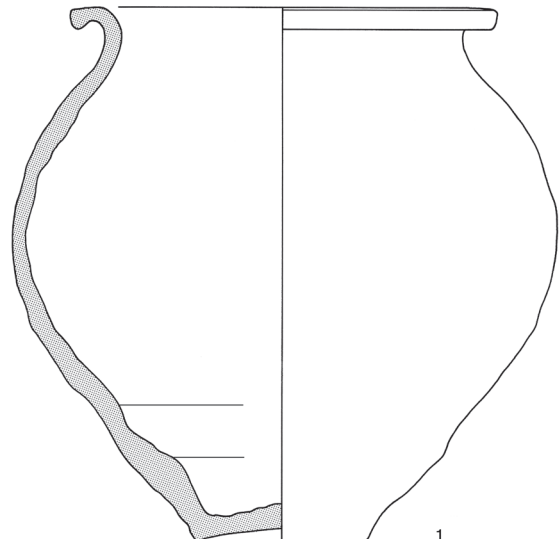

1

Grab 59



Antoninus Pius
140-144 n.Chr.

3

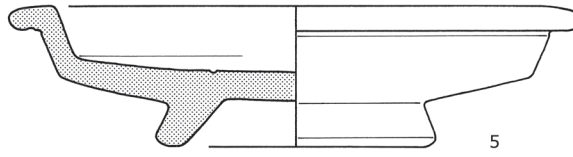

5

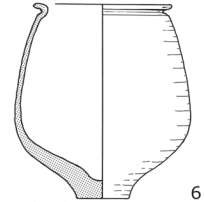

6

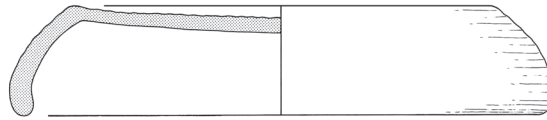

2

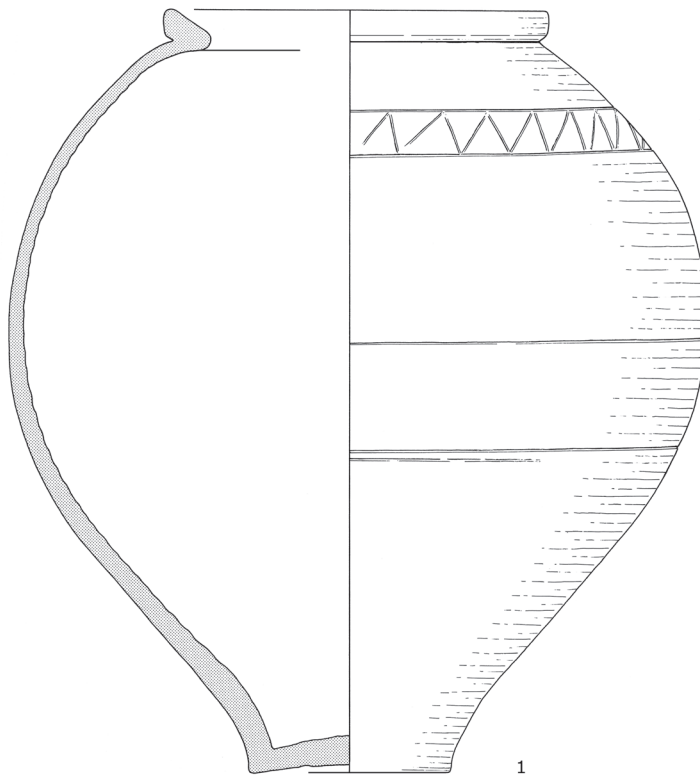

1

Grab 60



Nägel
Steinkugel



Antoninus Pius
151-152 n.Chr.

1

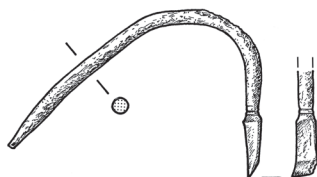

2

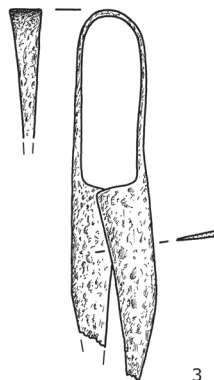

3

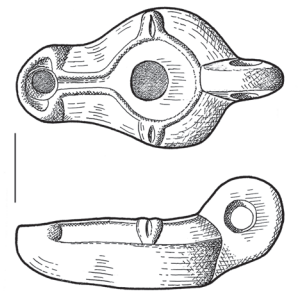

6

← Grab 60

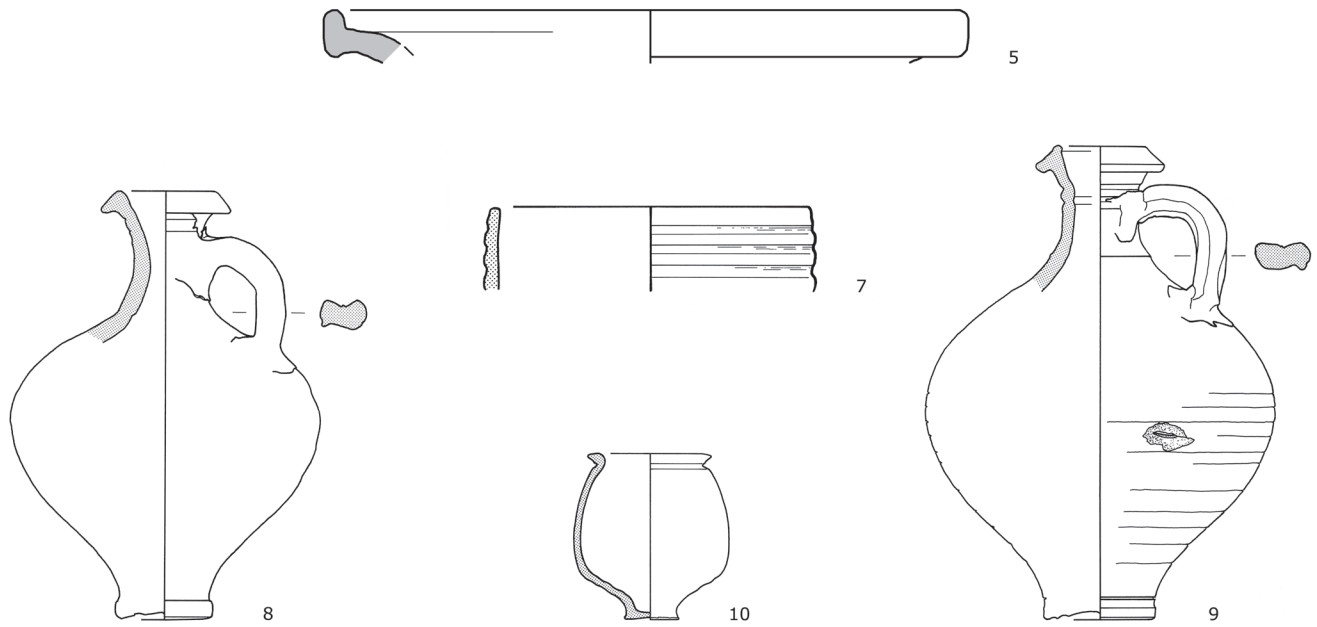

Grab 61



Nägel

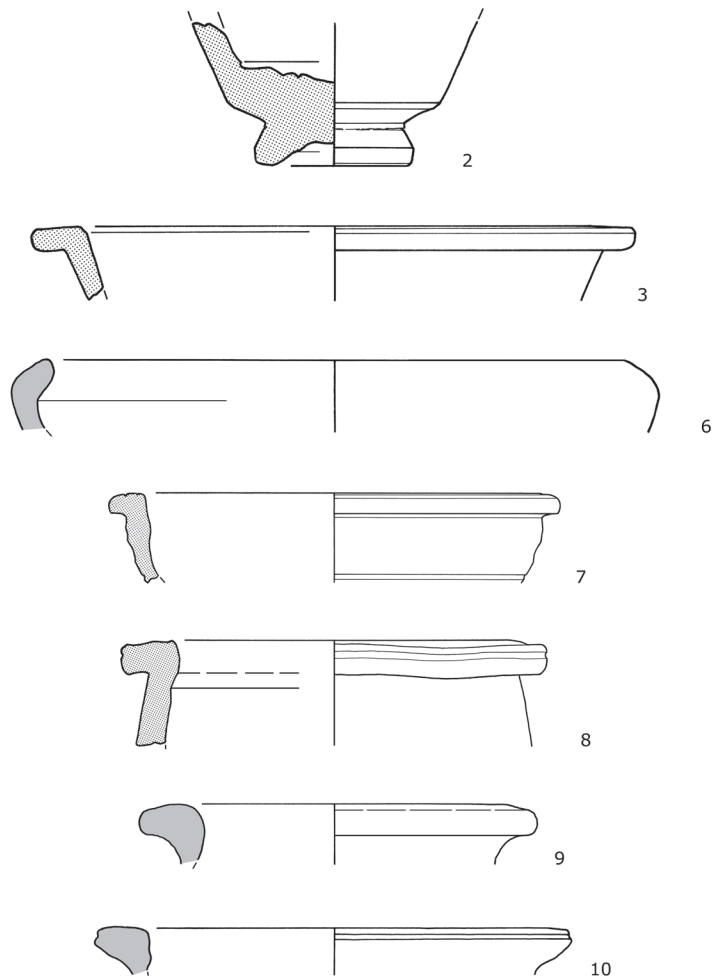

Grab 62 A



Grab 62 B



Nägel

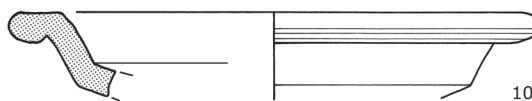
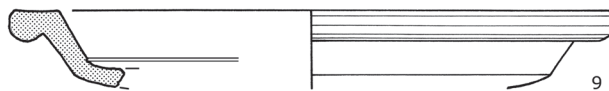
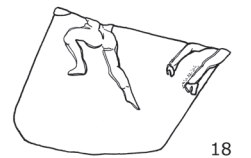
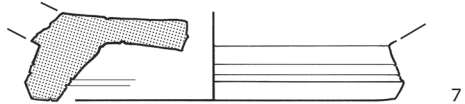
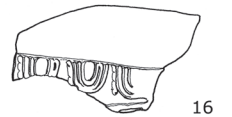
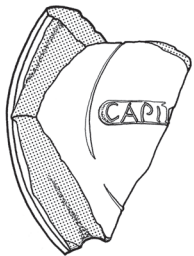
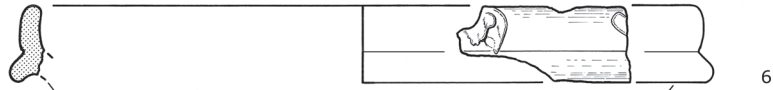
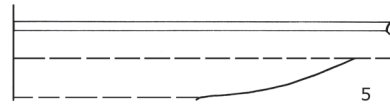
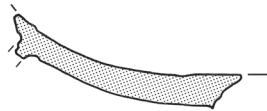
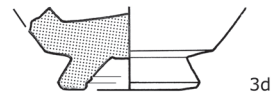
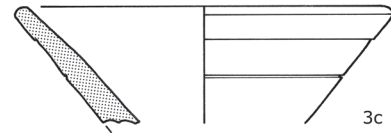
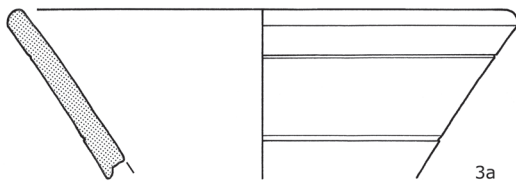
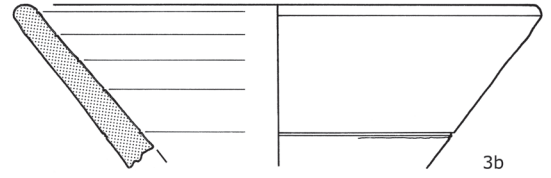
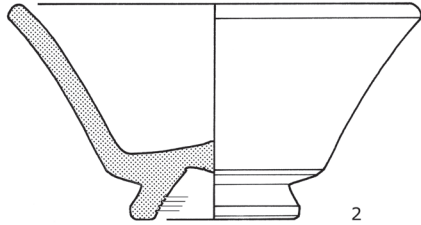

←
Grab 62 B

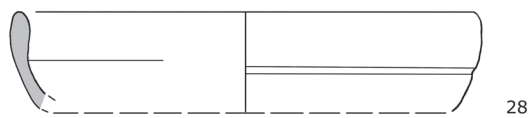
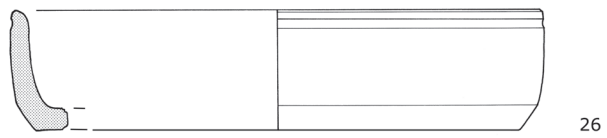
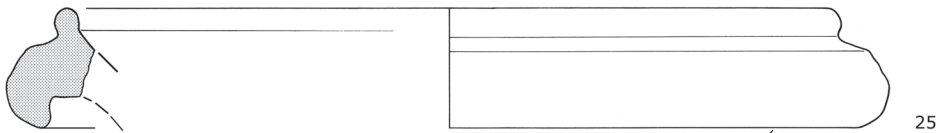
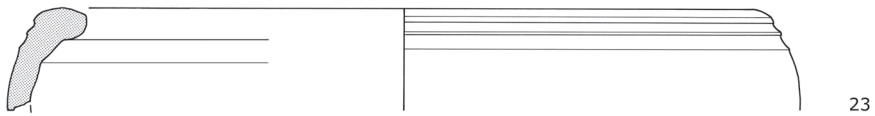
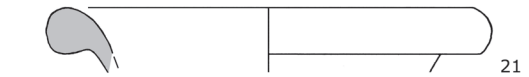
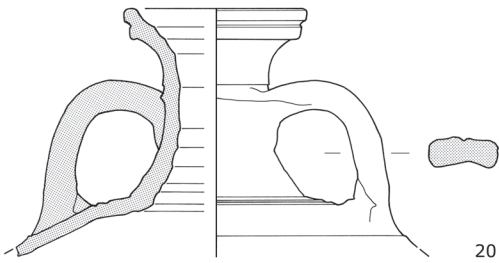
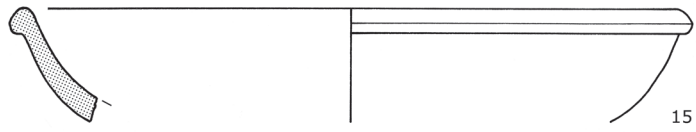
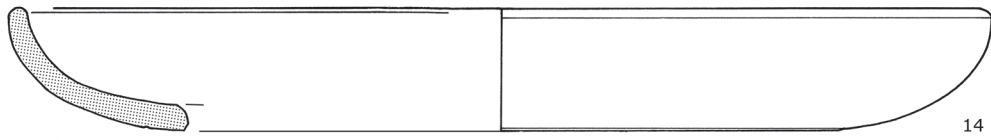
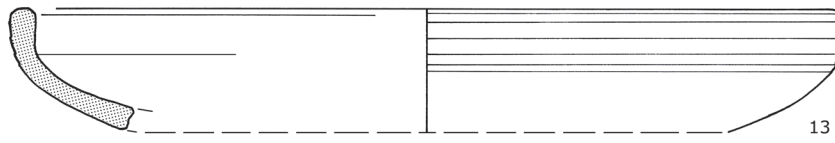
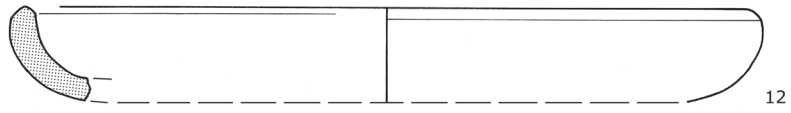

←← Grab 62 B

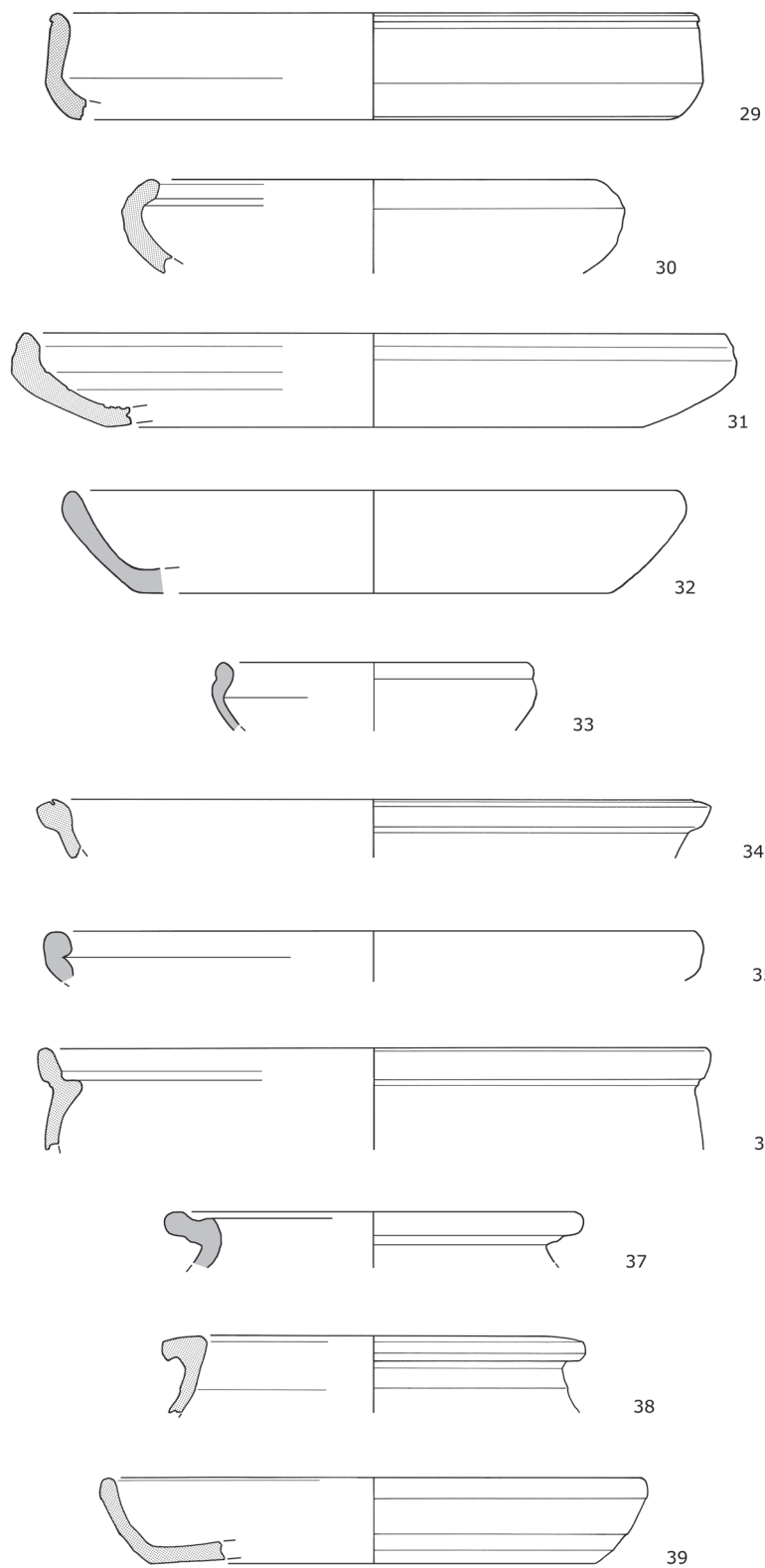

Grab 63



Grab 64



Feuerstahl

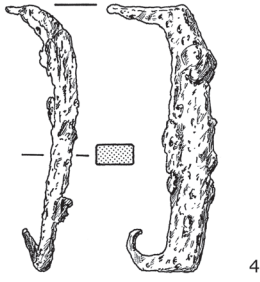

4



3

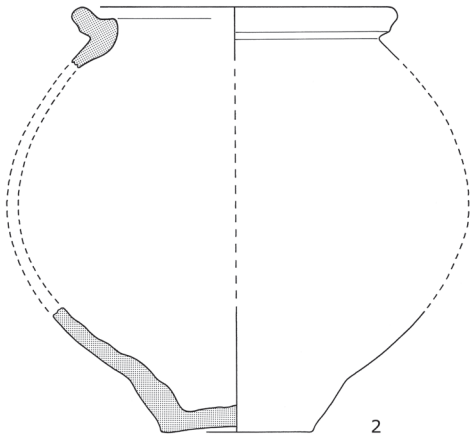

2

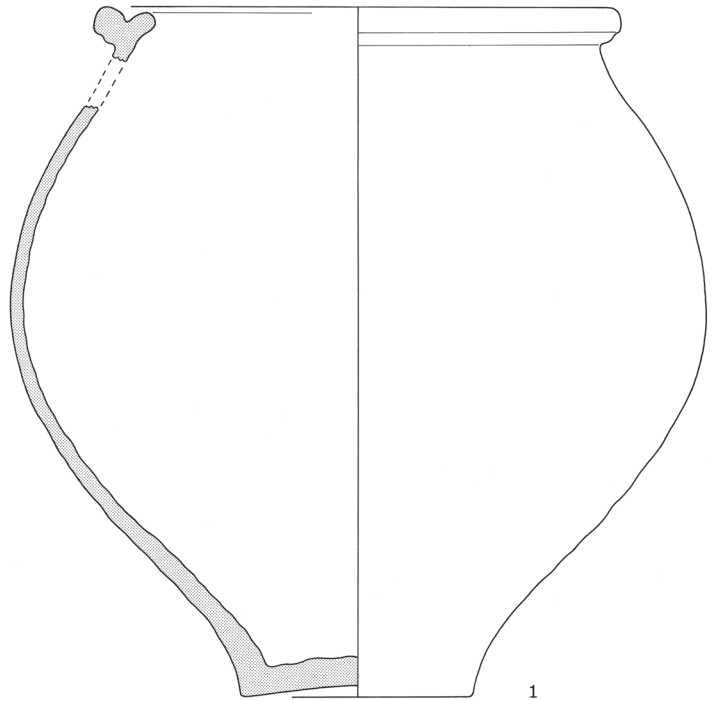

1

Grab 66

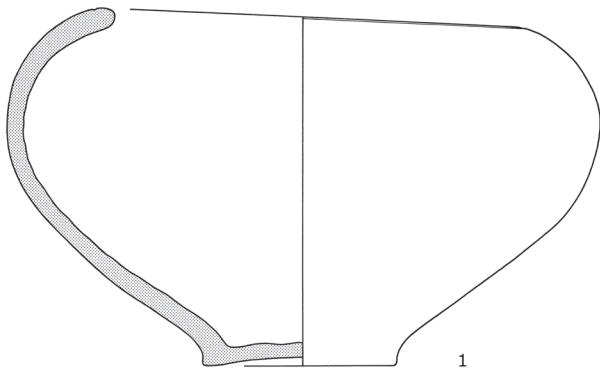

1

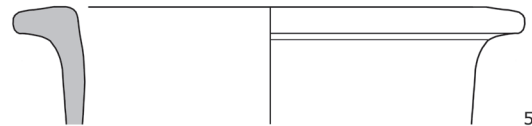

5

Fundstelle 65

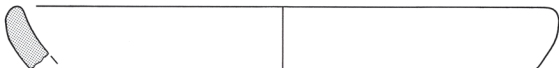

2



3

←
Fundstelle 65

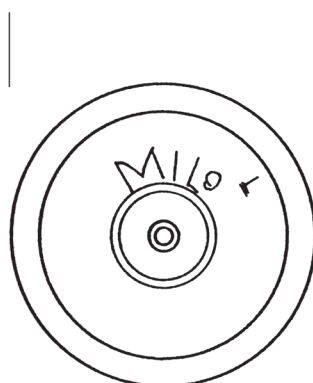

Fundstelle 65

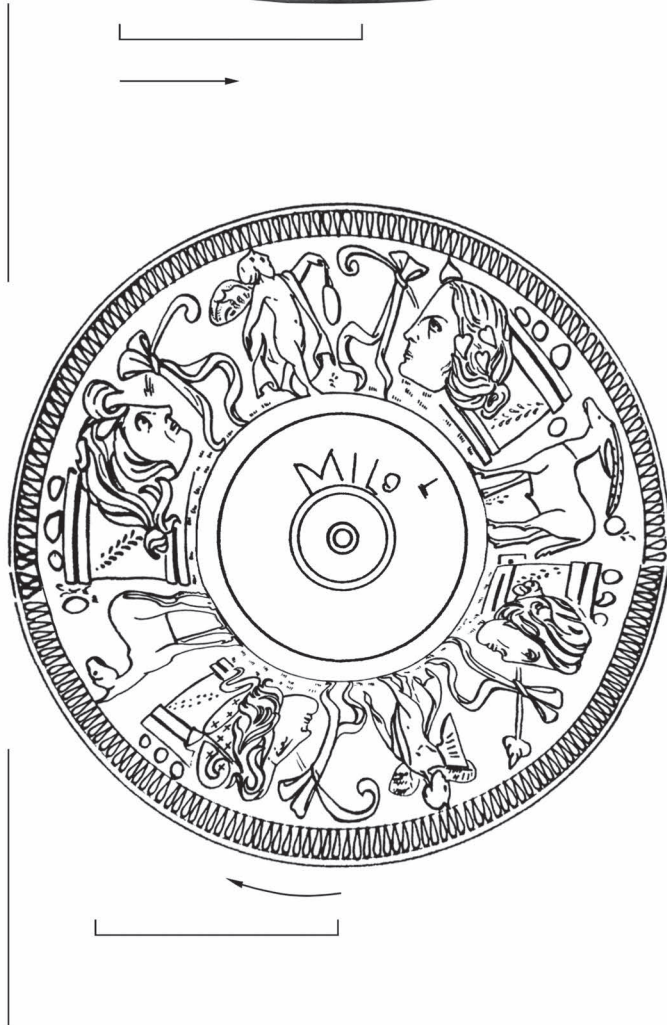

Grab 67

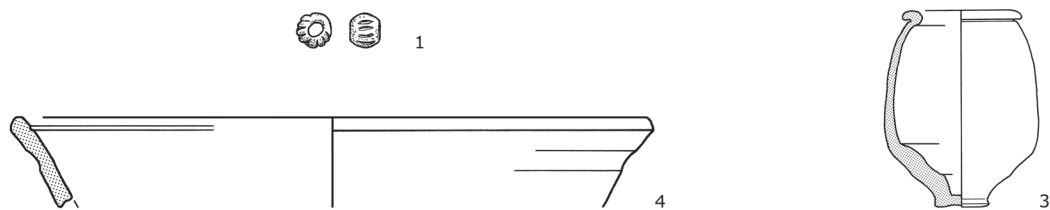

Grab 68



Ziegel

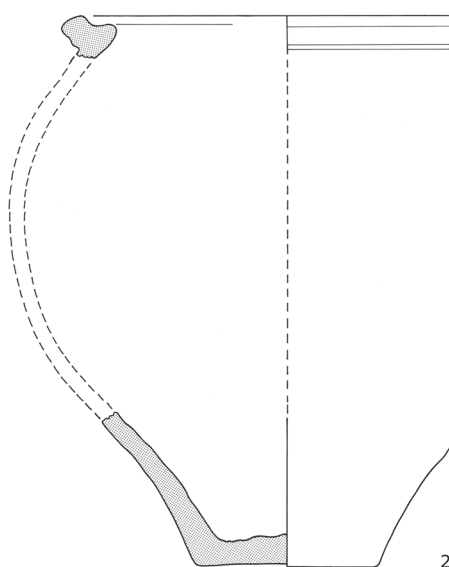

Grab 69

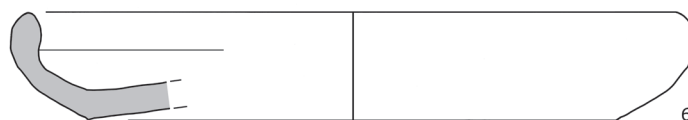
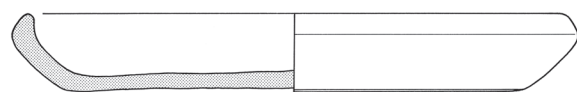
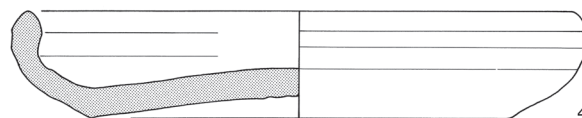
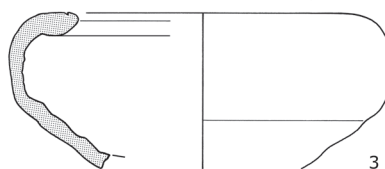
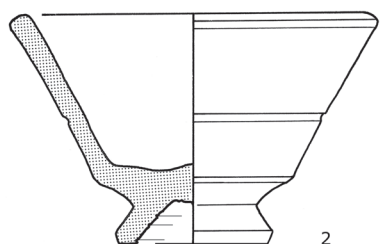
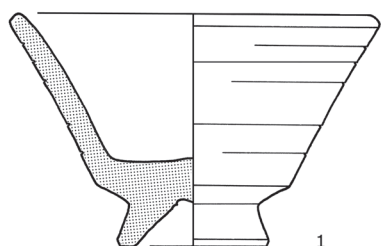

Grab 70



Nägel
Bronzeblech

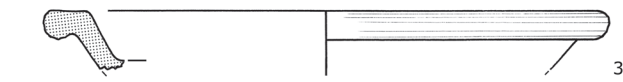

3

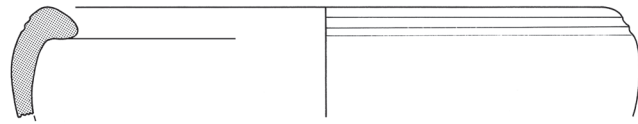

4

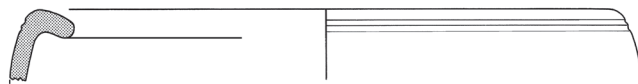

5



6

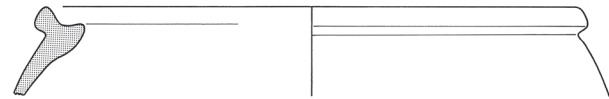

7



8



9



10



13

Grab 71

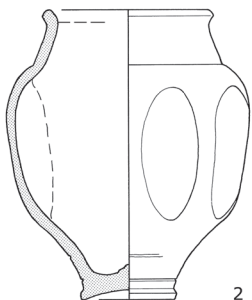

2

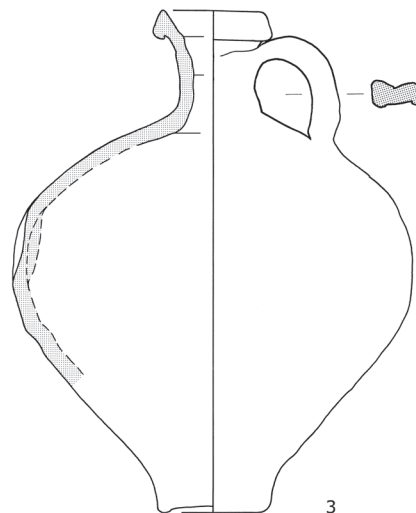

3

←
Grab 71

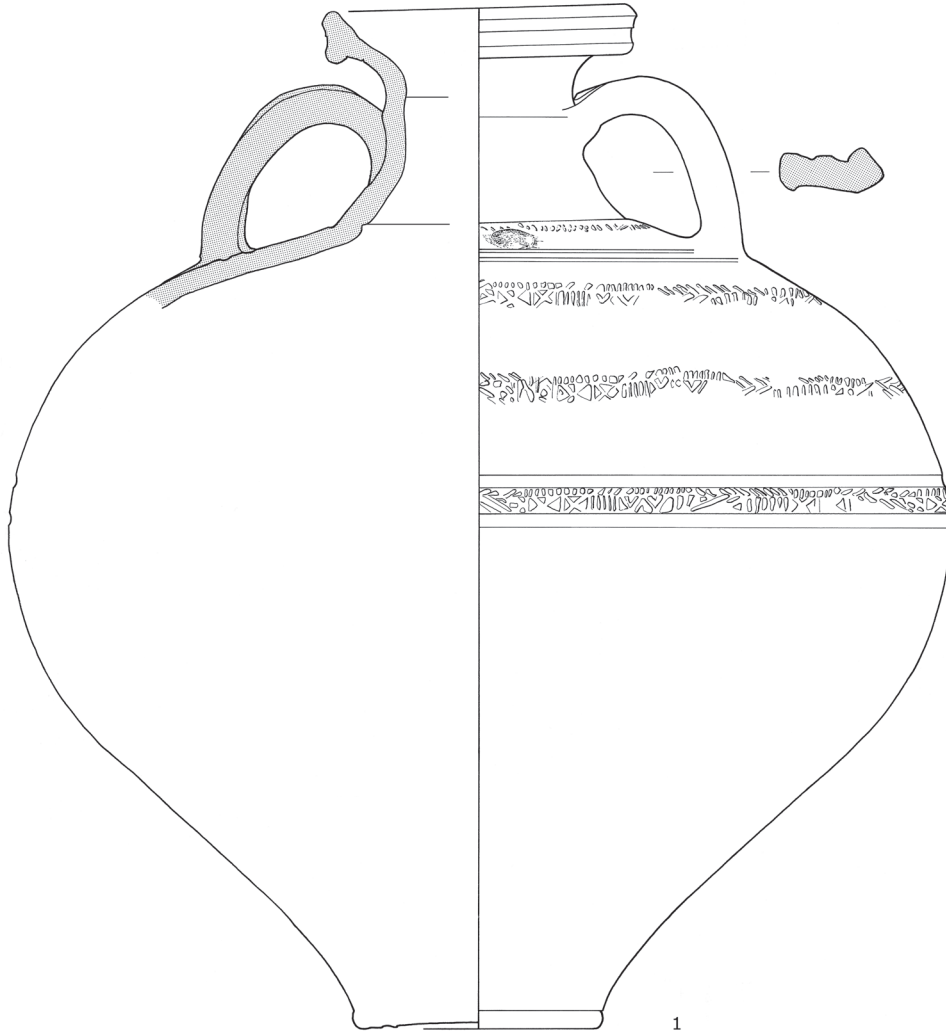

→
Grab 72

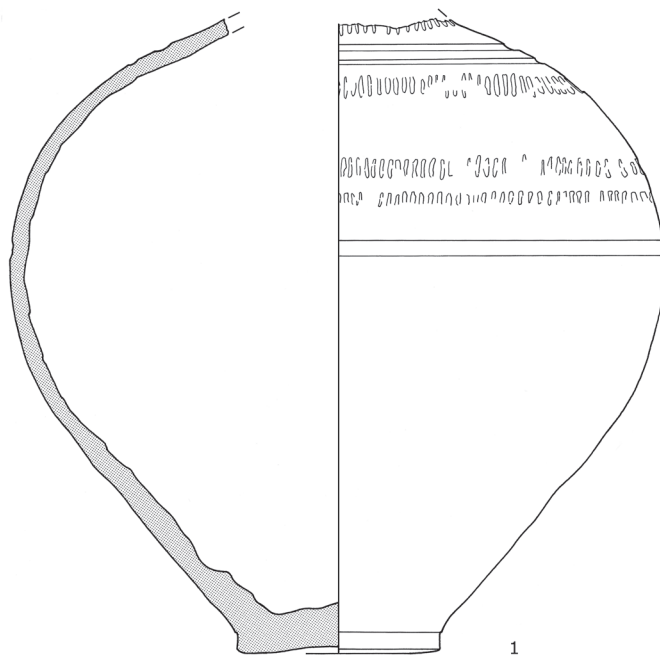

←
Grab 72

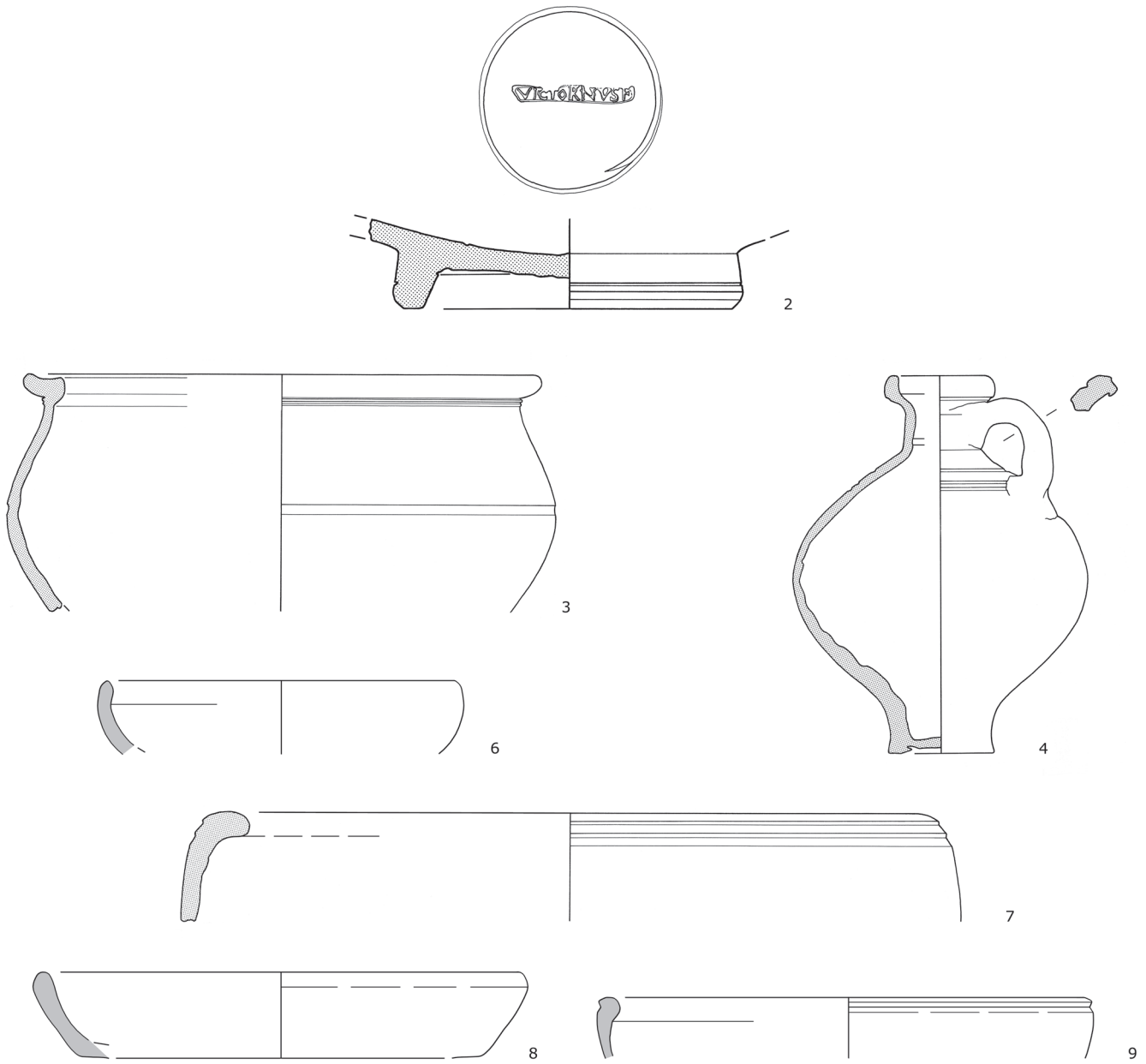

Grab 73



Nagel



3

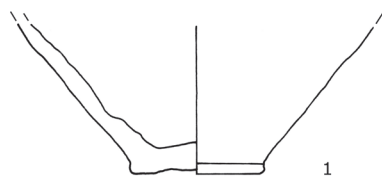

1



2



5

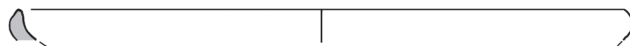

7

Grab 74



Schuhnagel

Marcus Aurelius
174-175 n.Chr.
As

1

2.Jh.n.Chr.
As

2

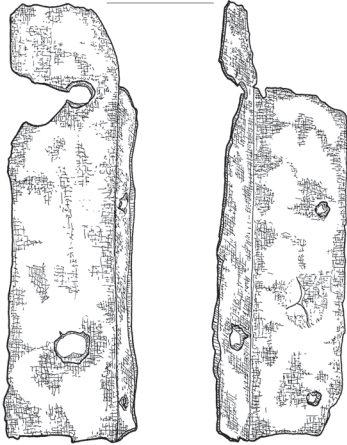

4

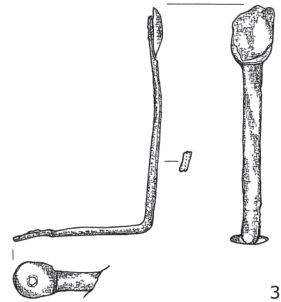
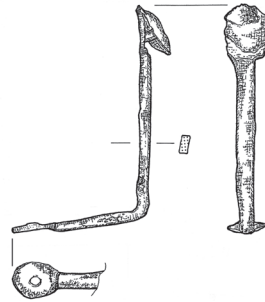

3

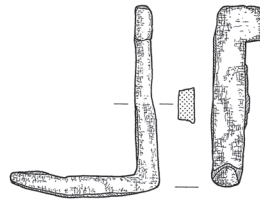

6

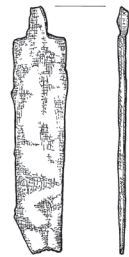

7

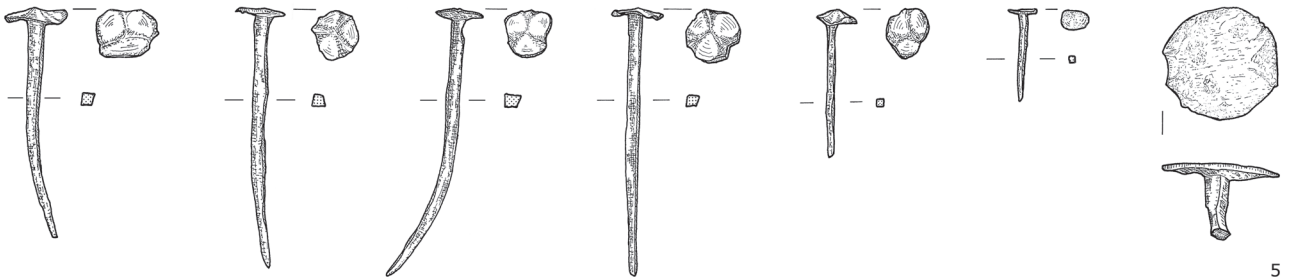

5

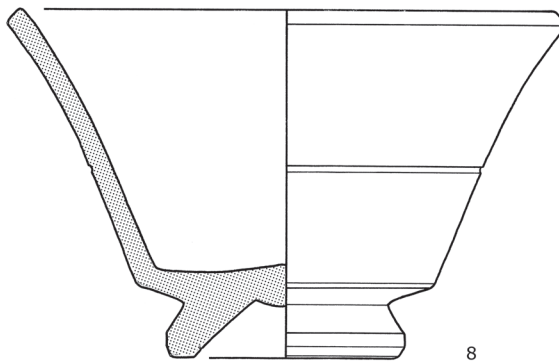

8

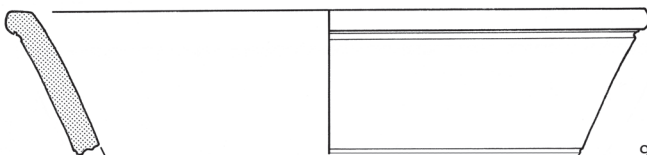

9

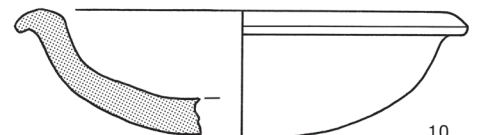

10

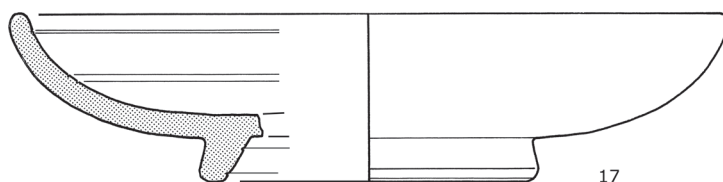
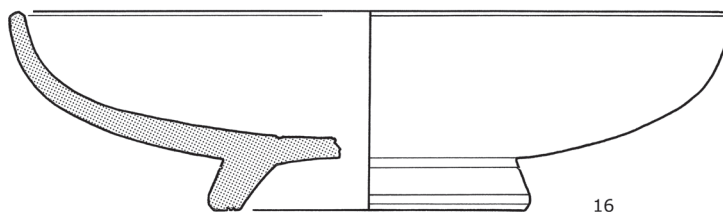
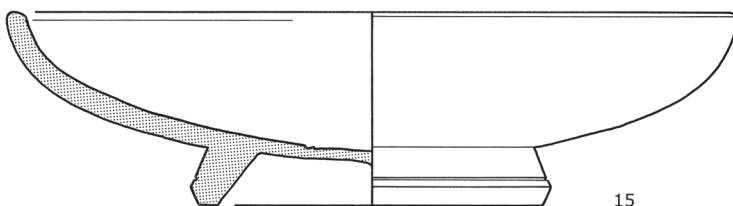
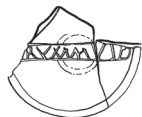
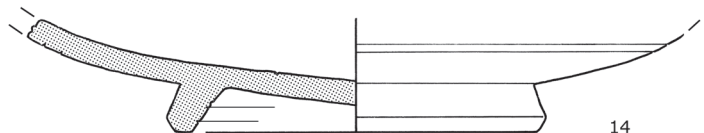
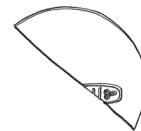
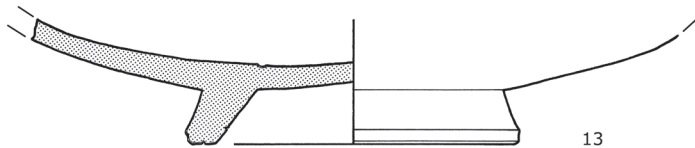
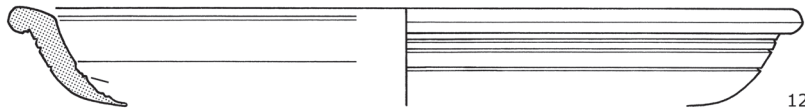
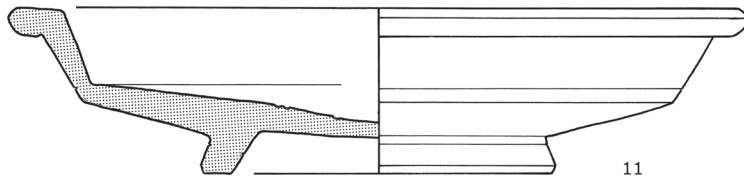

←←
Grab 74

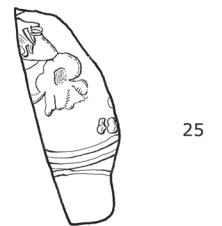
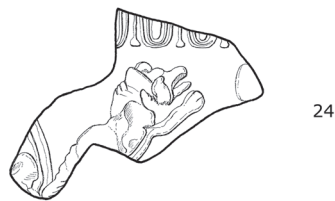
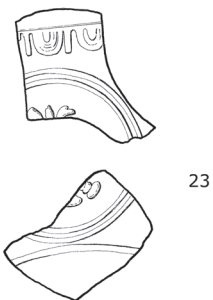
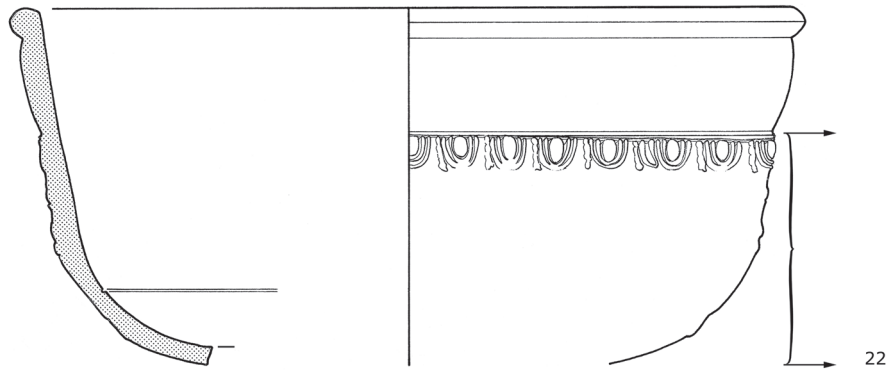
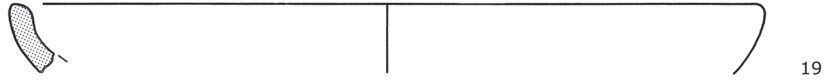
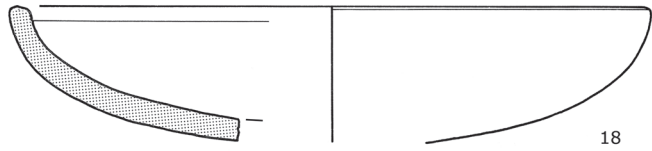

←←←
Grab 74

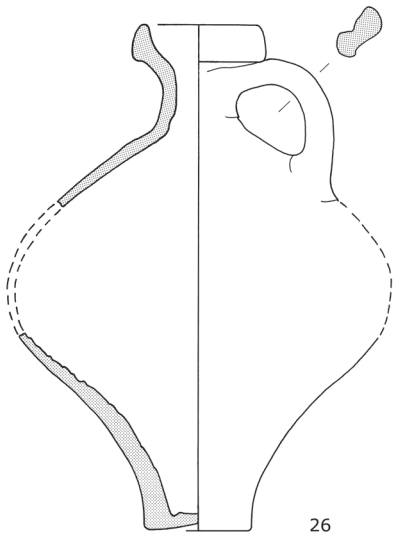

26

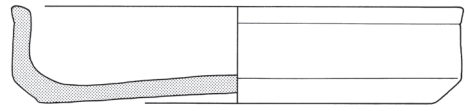

27



28

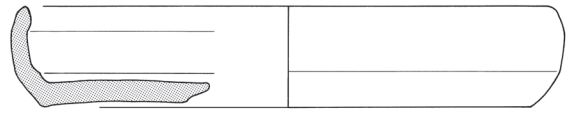

29

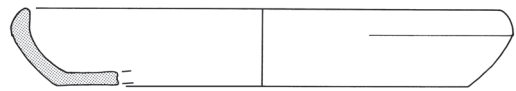

30



31

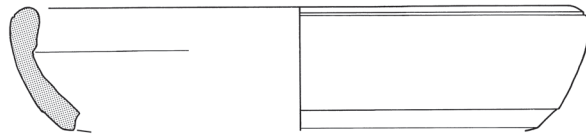

32

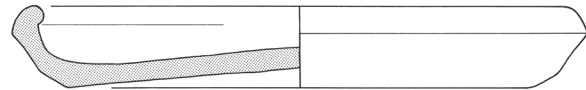

33

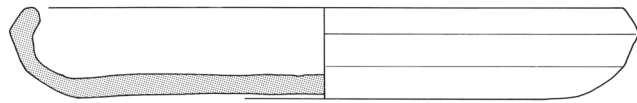

34

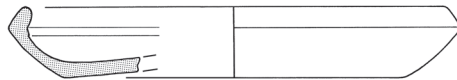

35

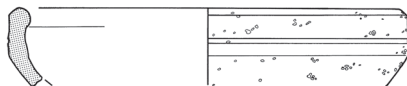

36

→ Grab 75

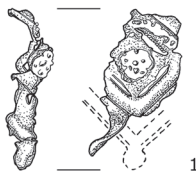

1

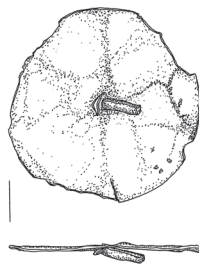

2



3

← Grab 75

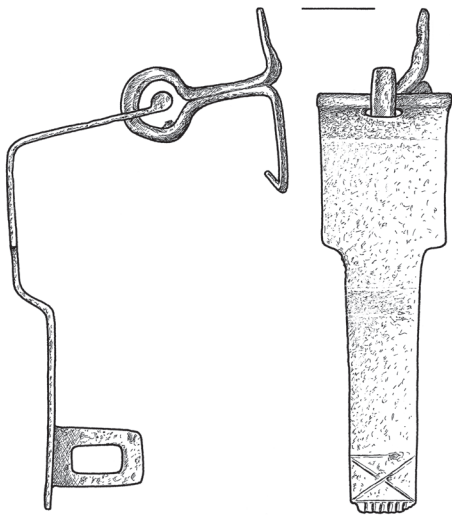

4

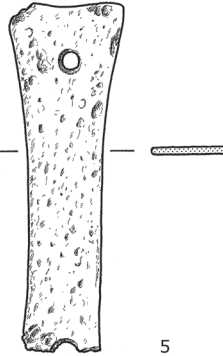

5

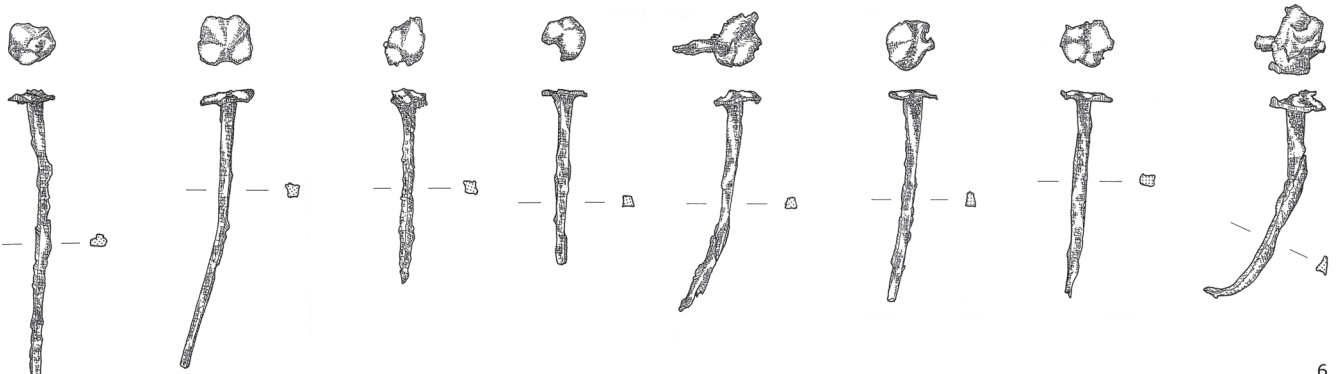
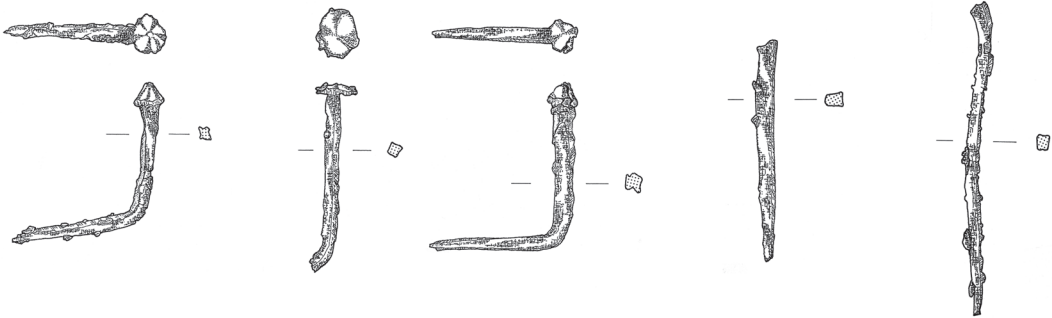
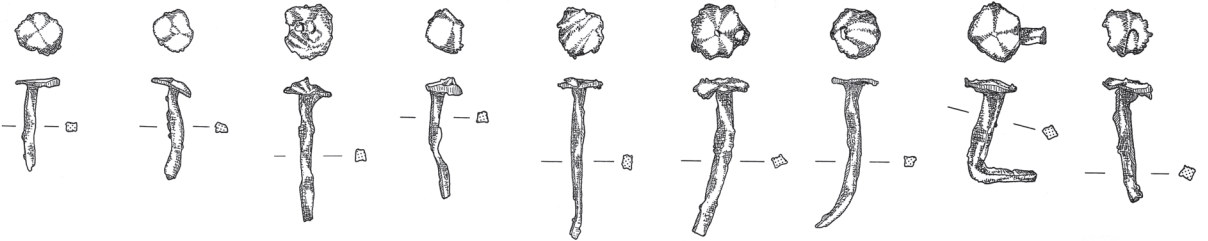
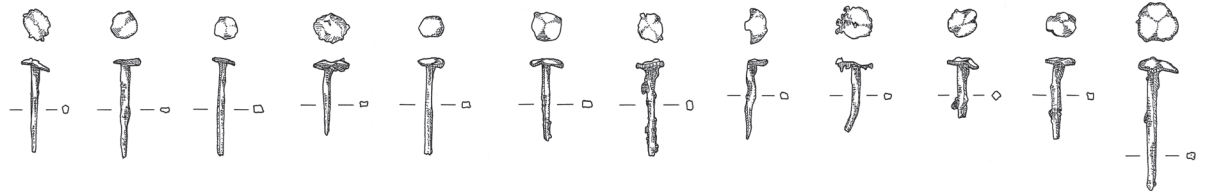
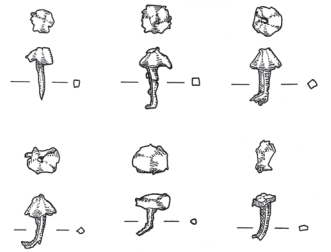
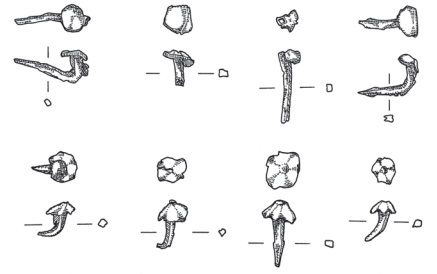

←←
Grab 75

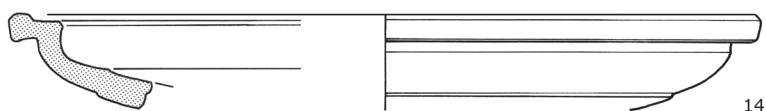
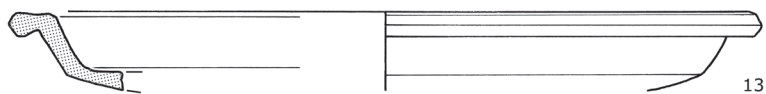
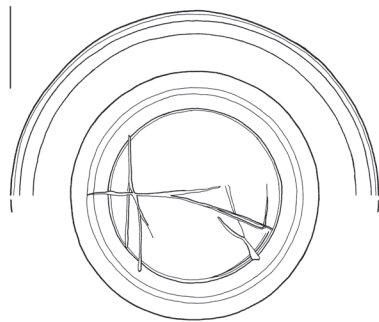
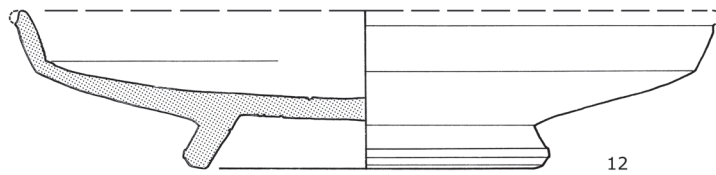
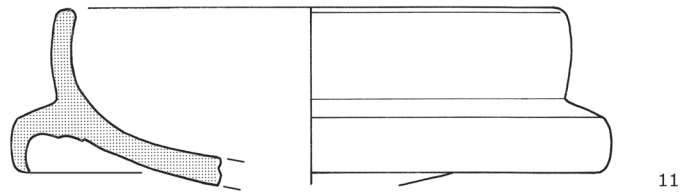
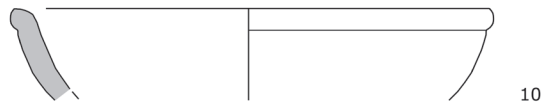
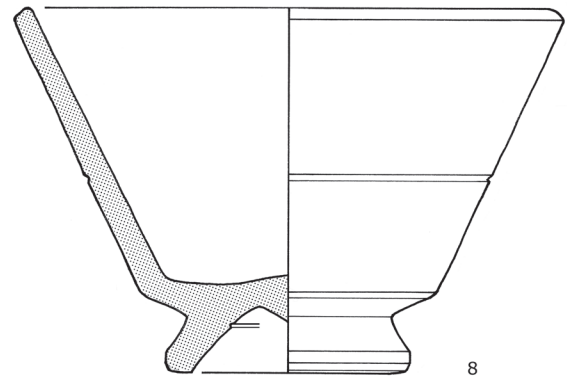
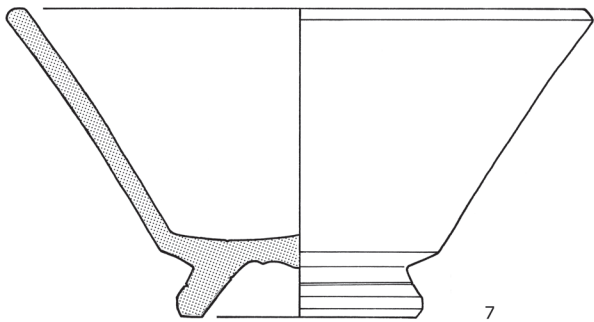

←←←←
Grab 75

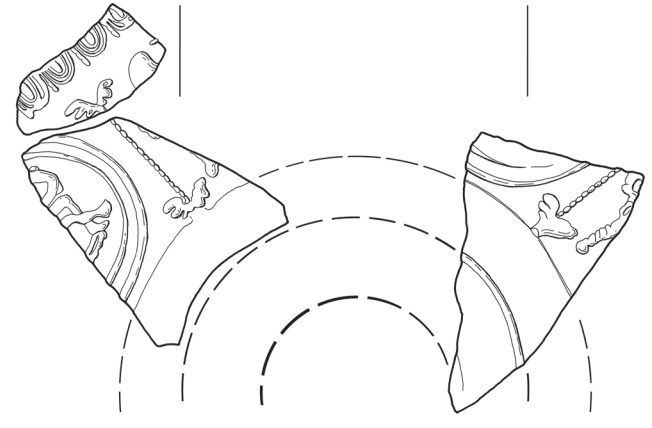
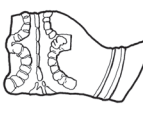
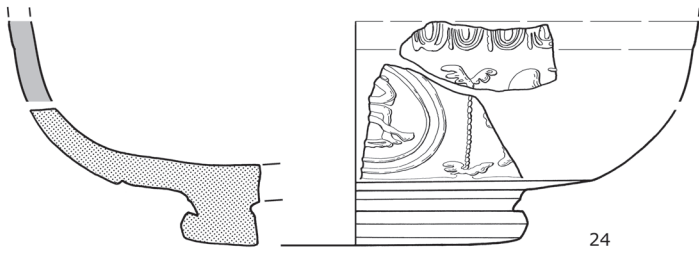
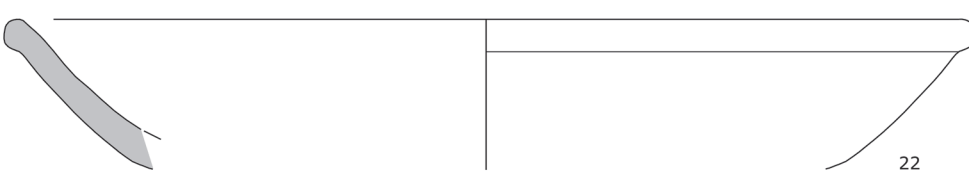
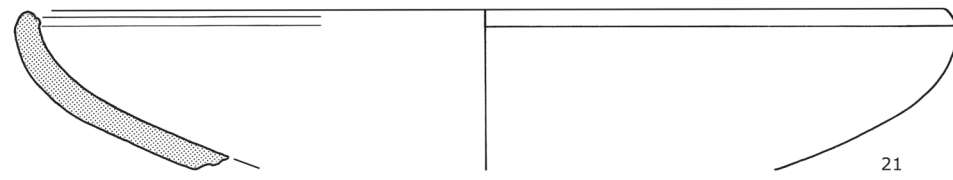
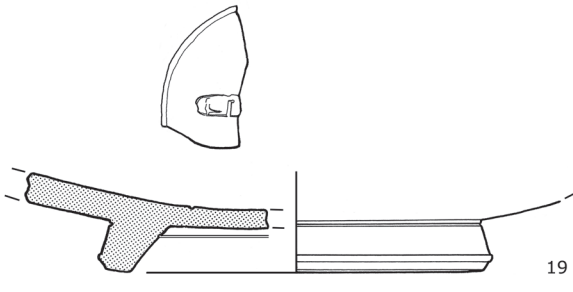
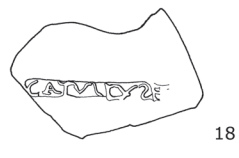
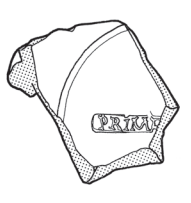
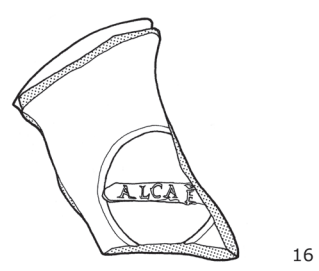
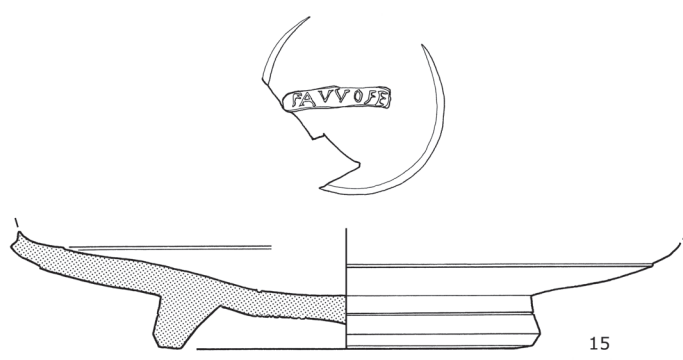

←←←←
Grab 75

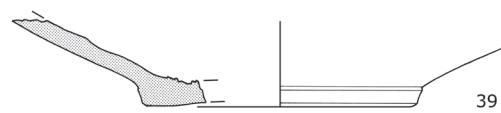
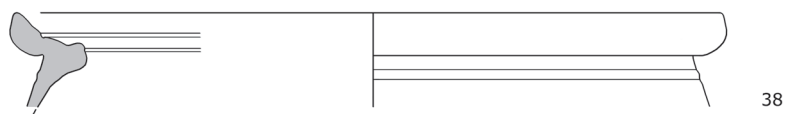
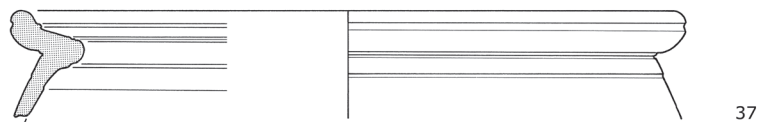
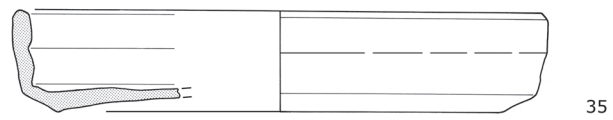
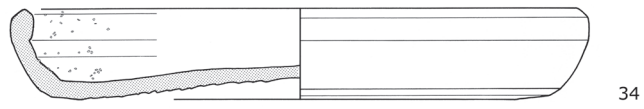
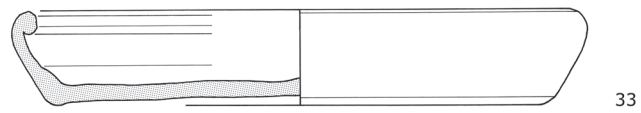
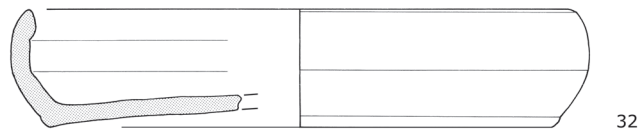
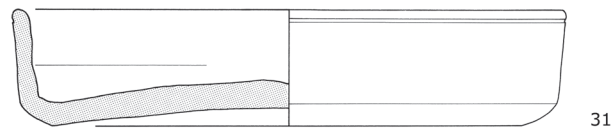
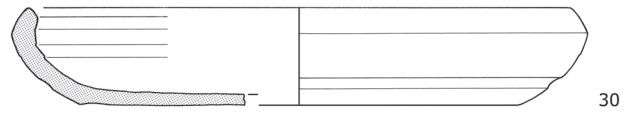
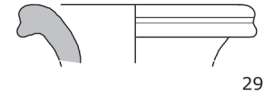
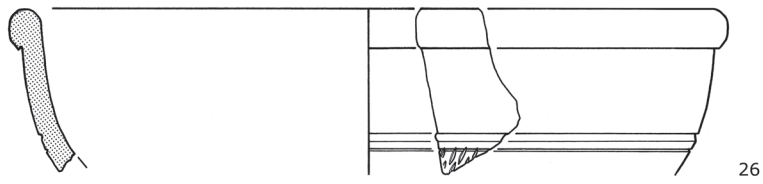

Grab 76

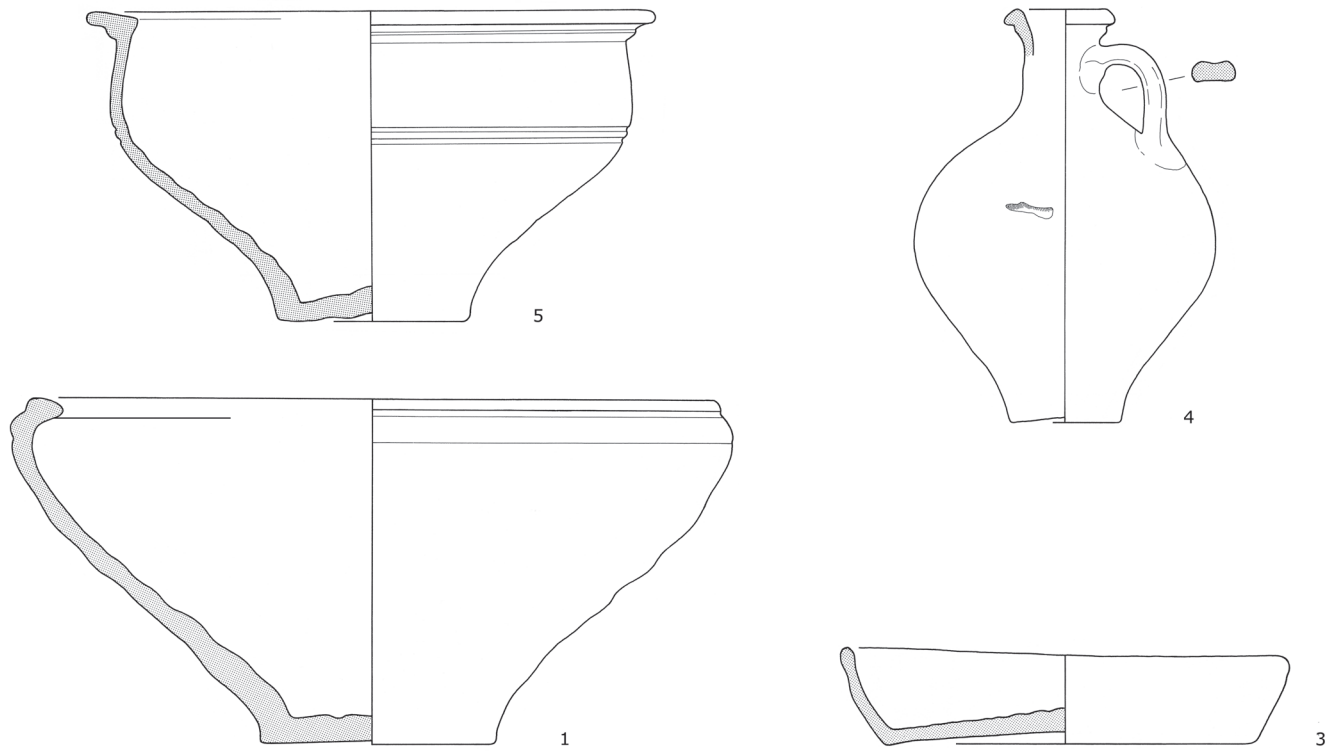

Grab 77



Keramik

Fundstelle 78



Nagel

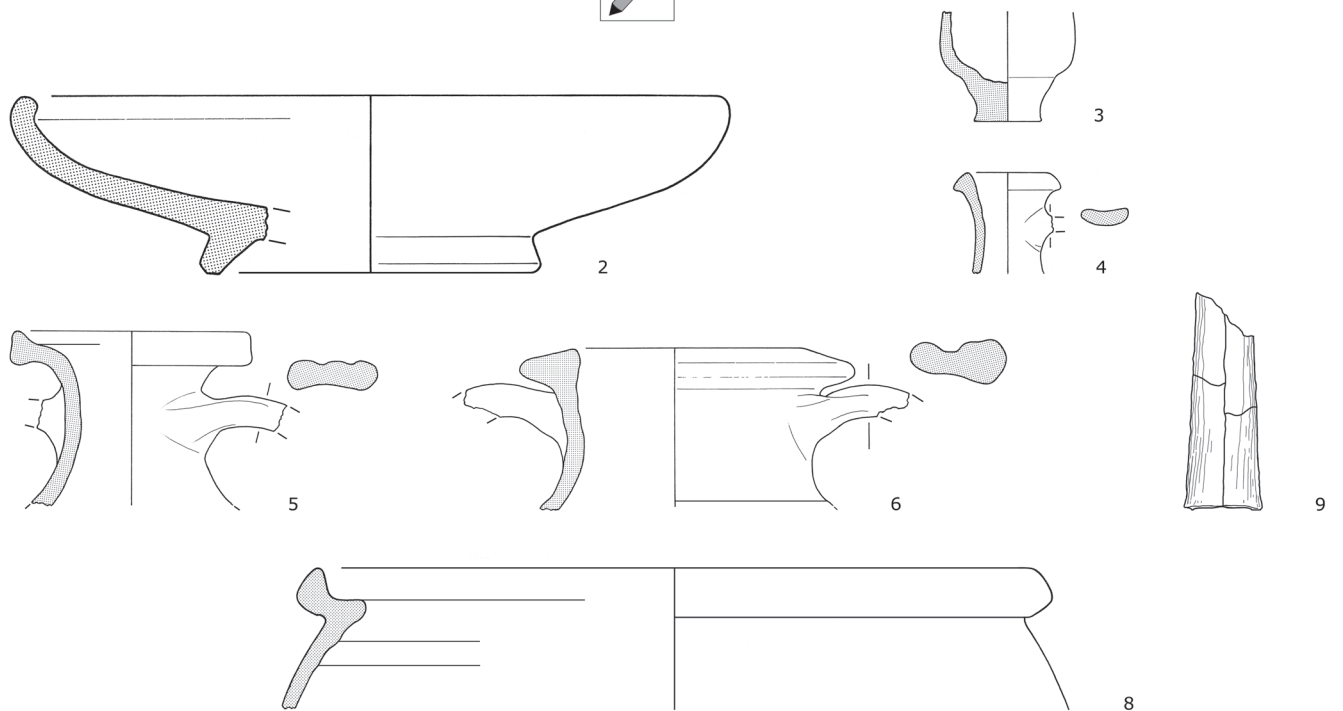

Grab 79



Nägel

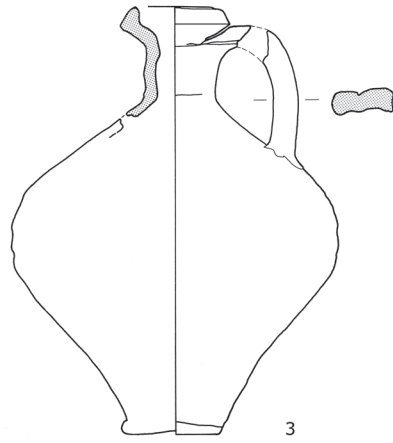
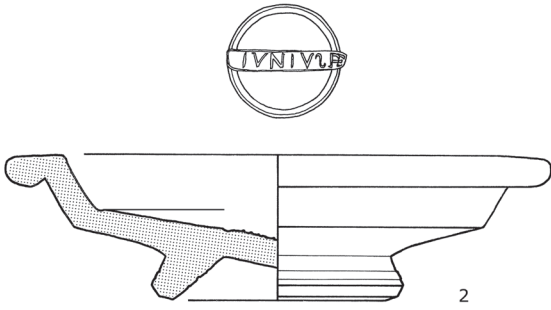

Grab 80

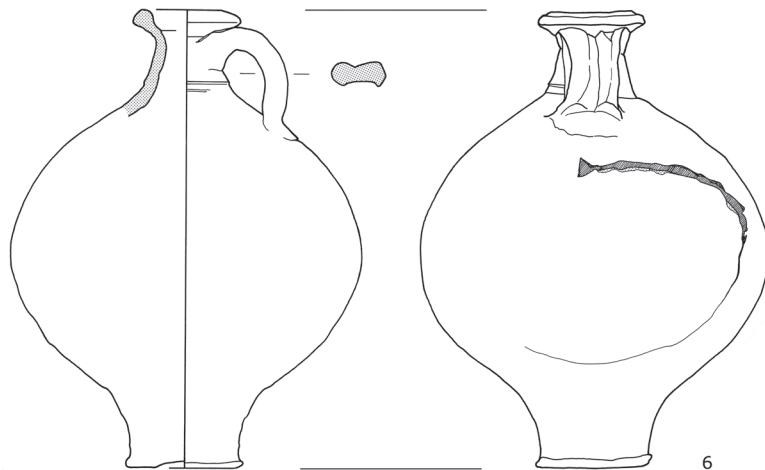
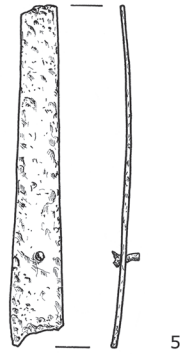
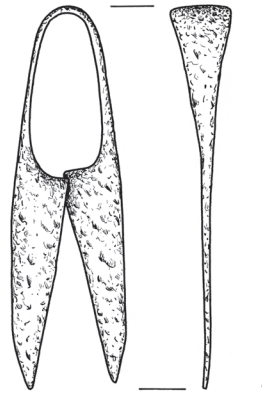
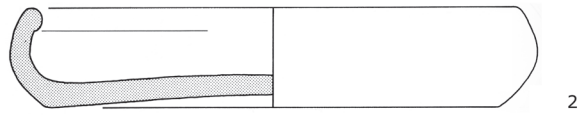
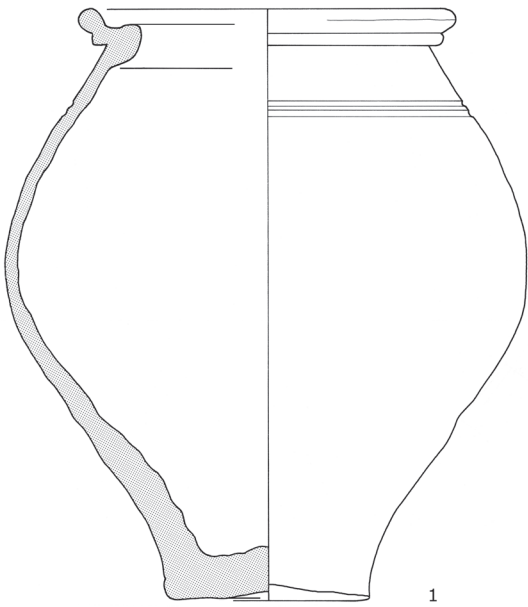

Grab 81



Reliefstein

Grab 82



Nägel

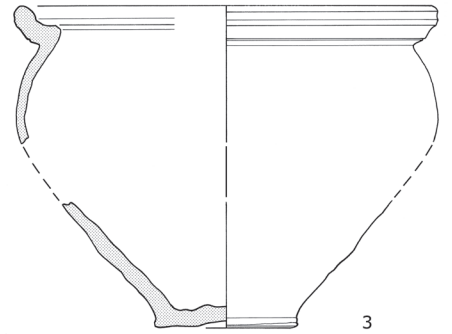
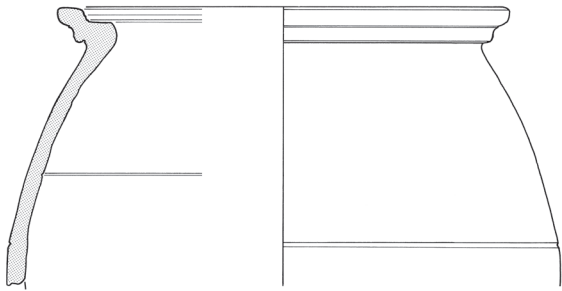
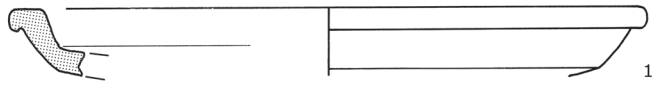

Grab 83

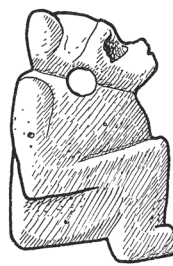
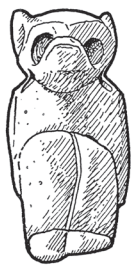
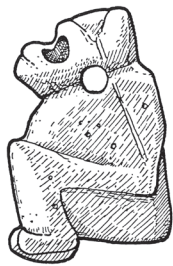

Grab 85

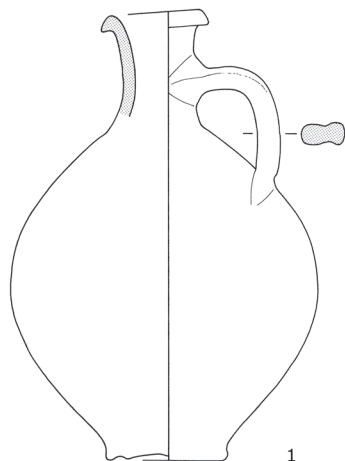

Grab 84



Grab 86



Grab 87

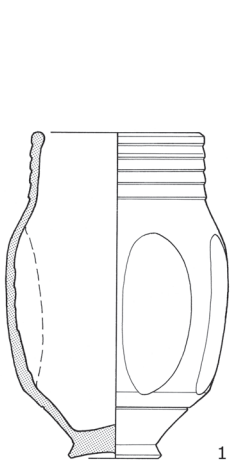

1

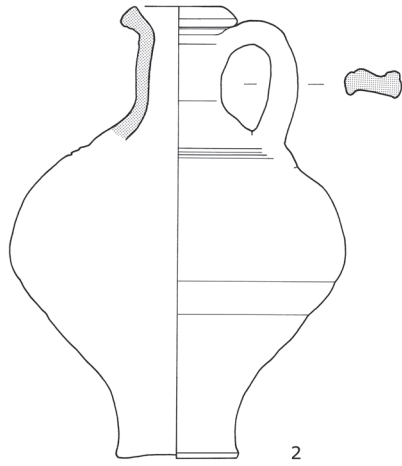

2

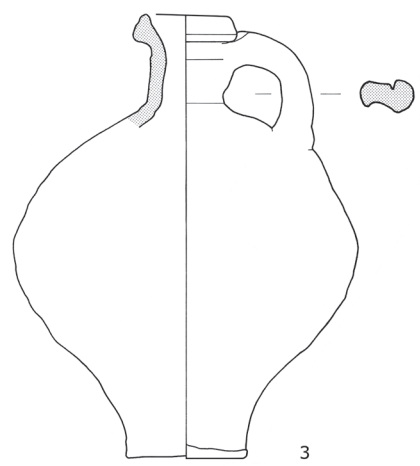

3

Grab 88

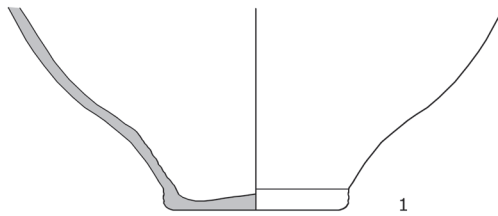

1

Grab 89



Nagel
Ziegel



2

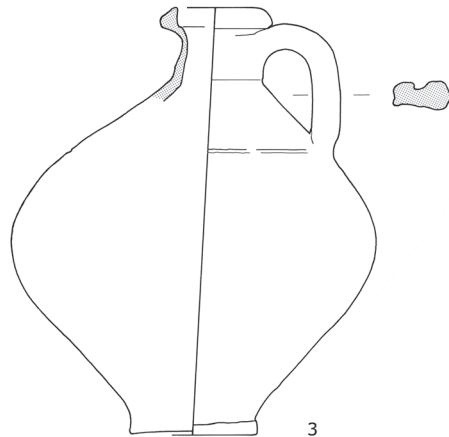

3

Grab 90 =>
Fundstelle 243



Steinsockel
Keramik

Grab 91

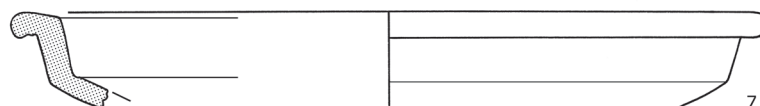
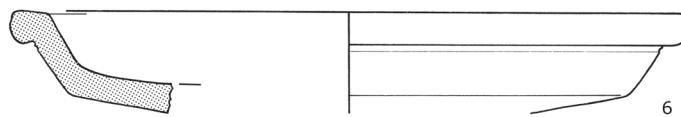
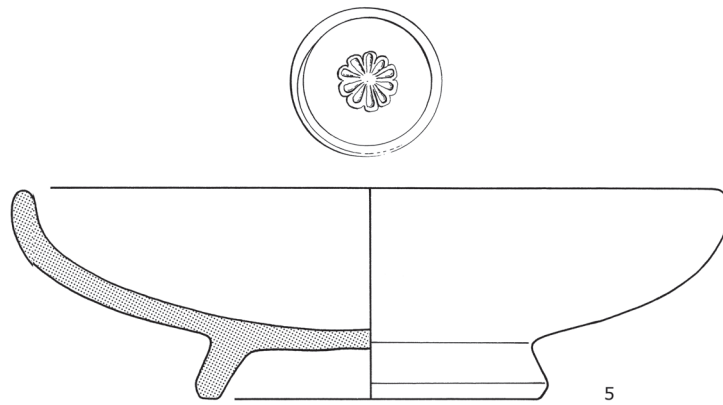
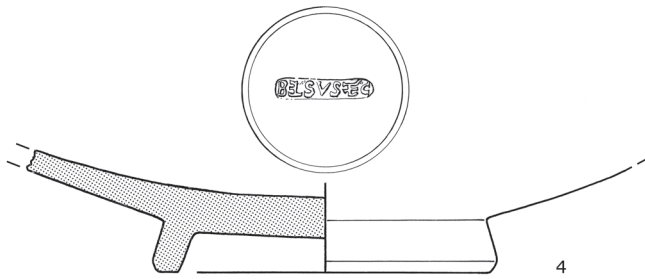
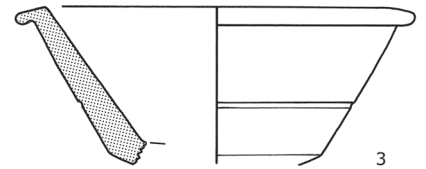
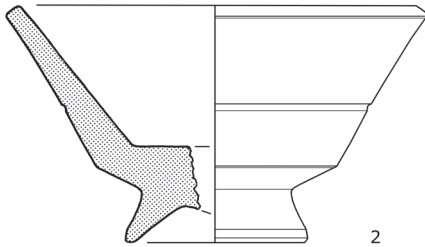
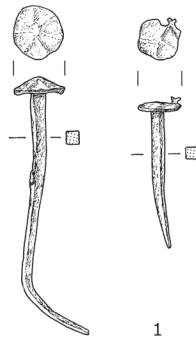

←
Grab 91

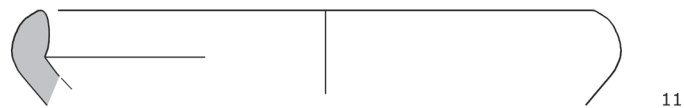
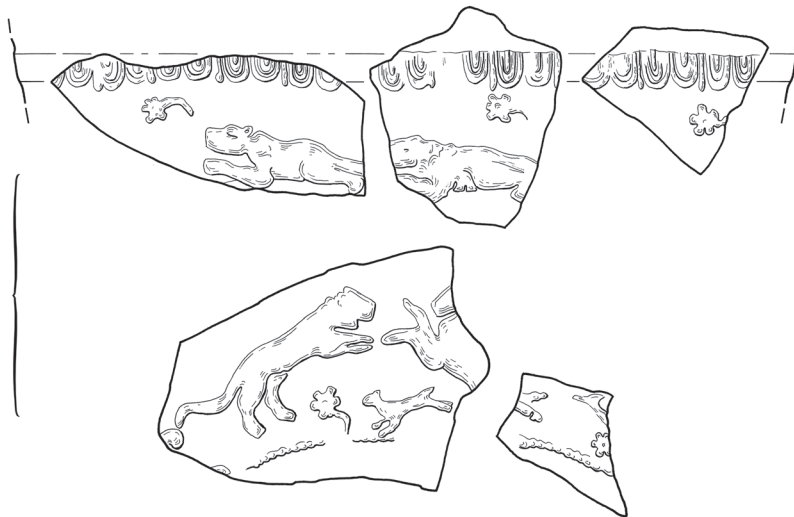
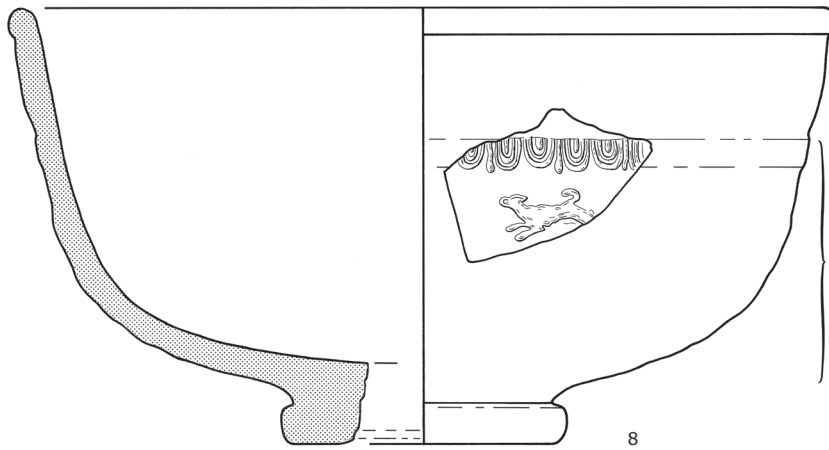

Grab 92



Grab 93



Glas
Nägel
Schuhnägel

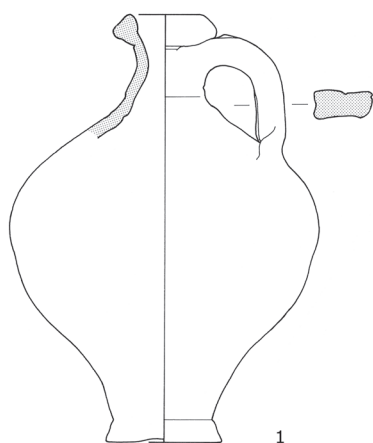

Grab 94

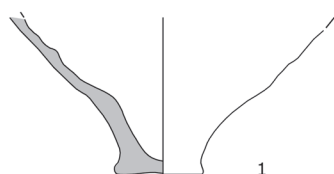

Grab 96



Grab 95



Nägel



Grab 97



Nägel

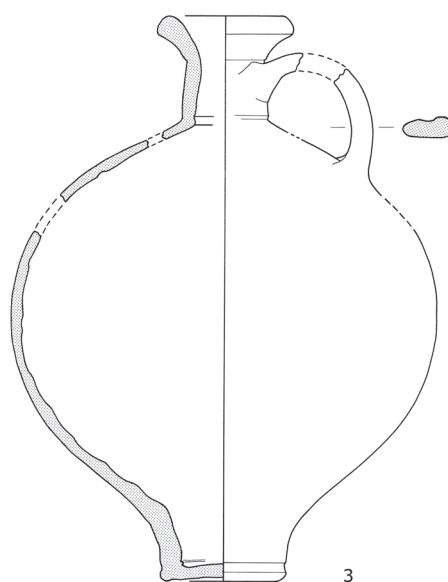
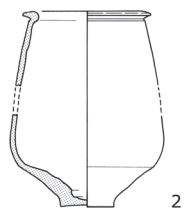

Grab 98



Glas
Nägel

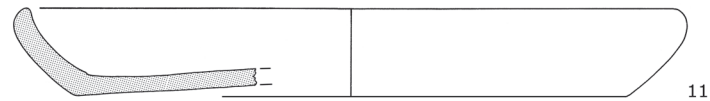
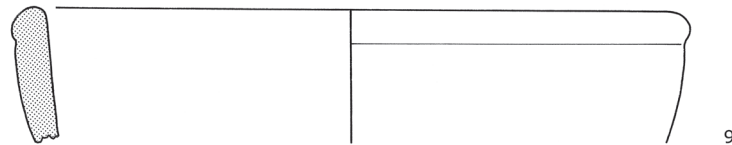
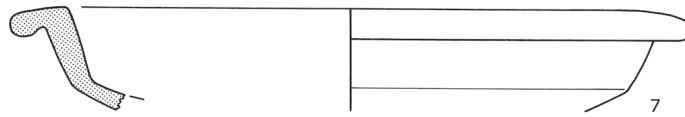
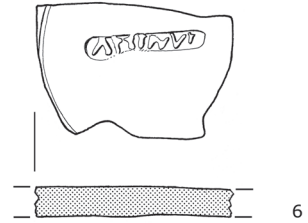
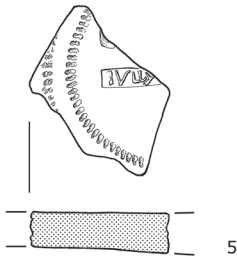
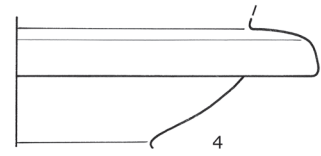
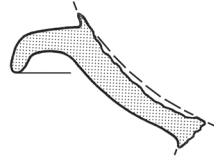
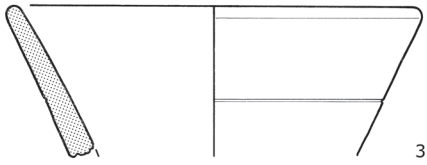

Fundstelle 99



Glas
Nägel
Bein

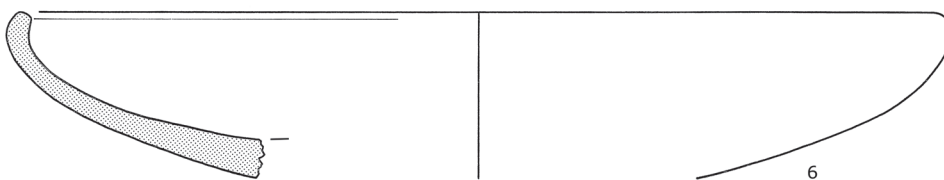
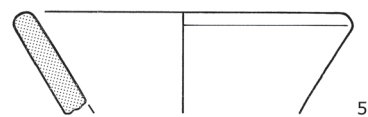
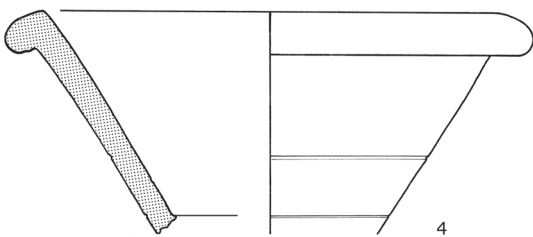

→ Fundstelle 99

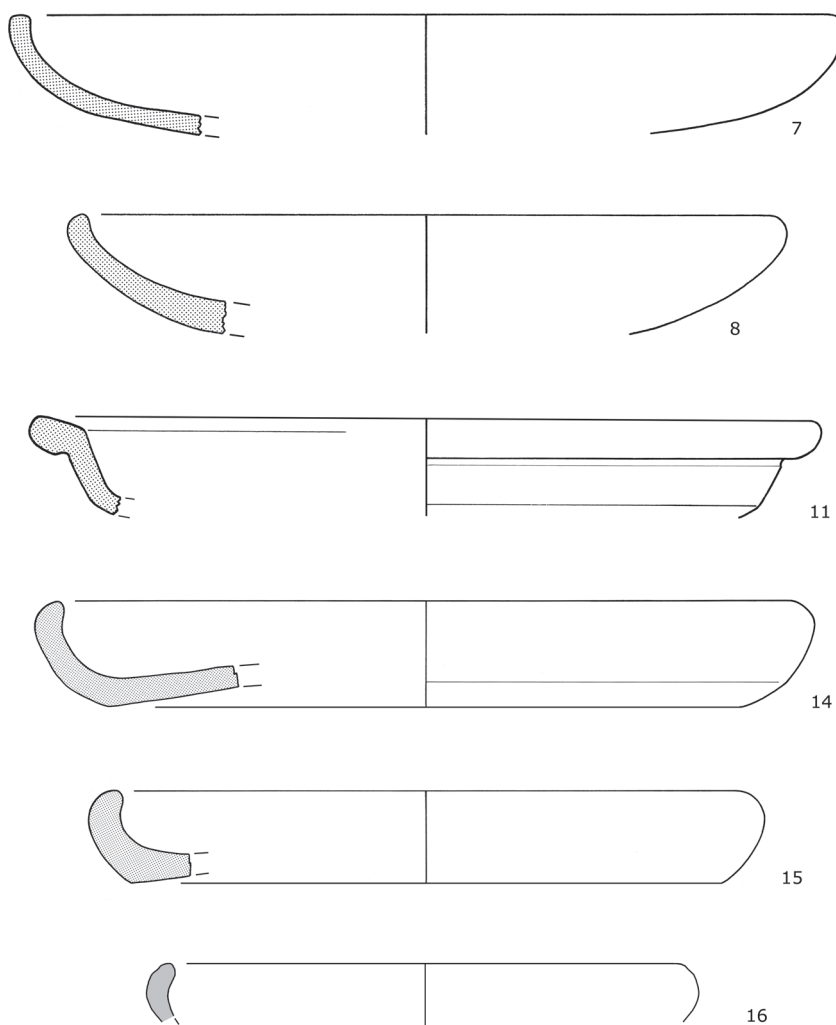

→ Grab 100

♂?



Nägel
Schuhnägel

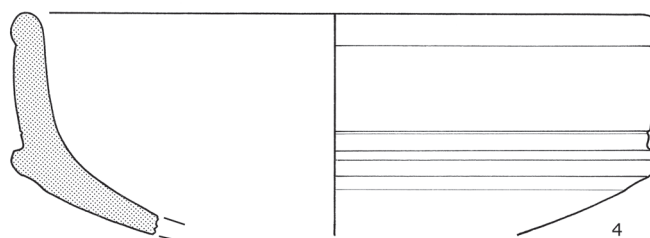
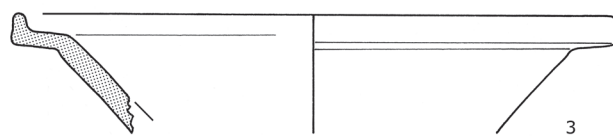
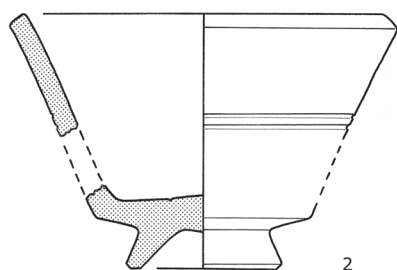

← Grab 100

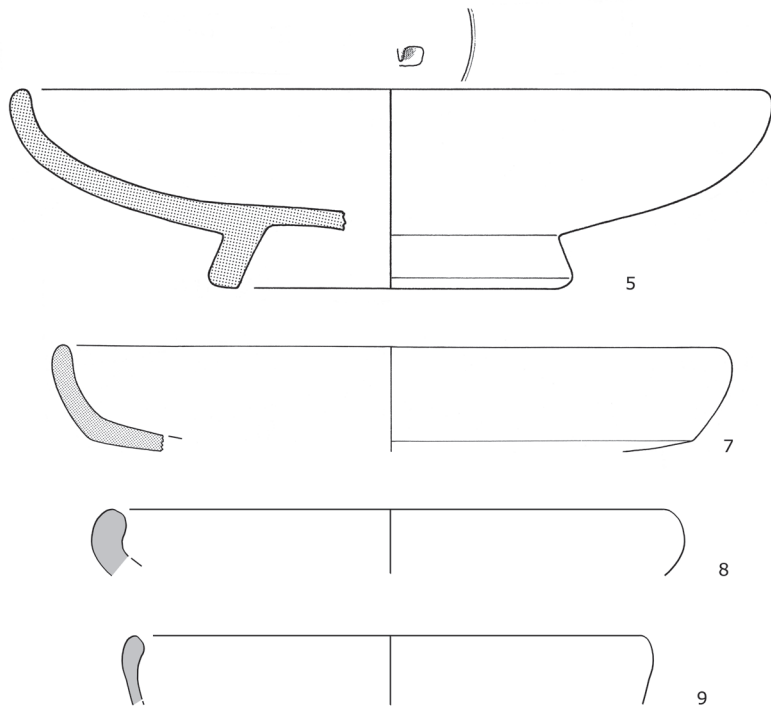

Grab 101



Schuhnagel

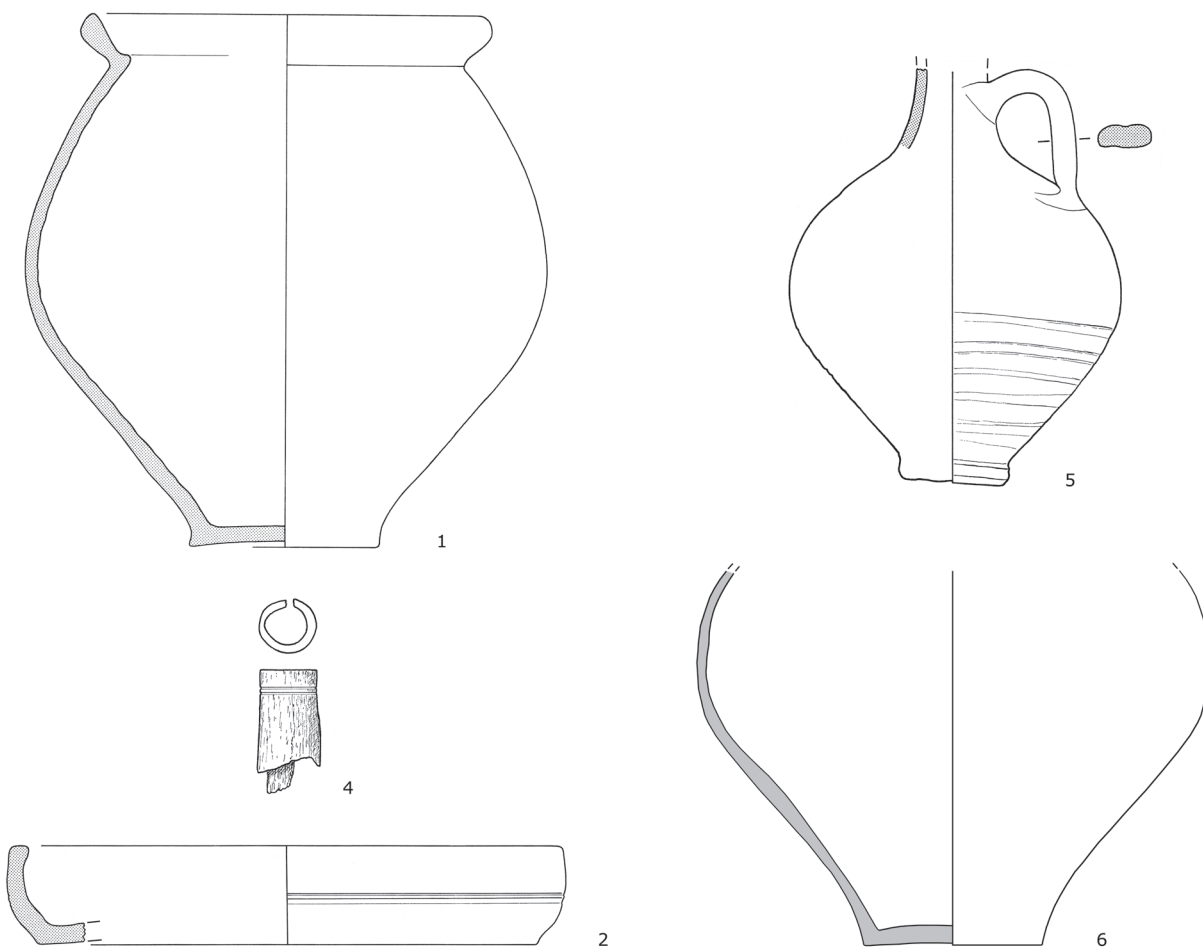

Grab 102

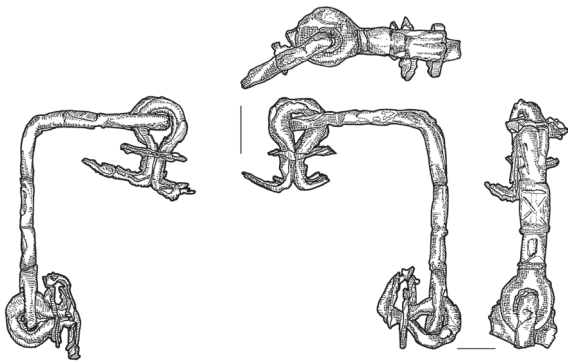

1

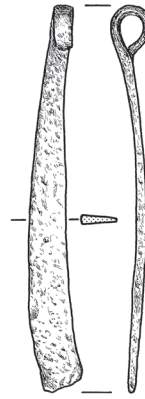

2

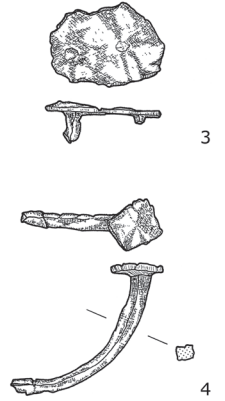

3

4

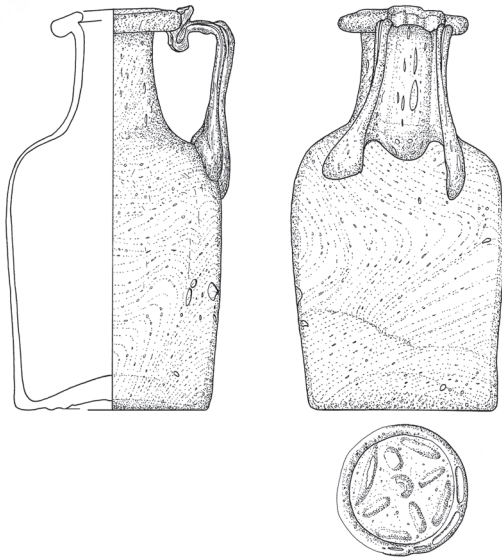

5

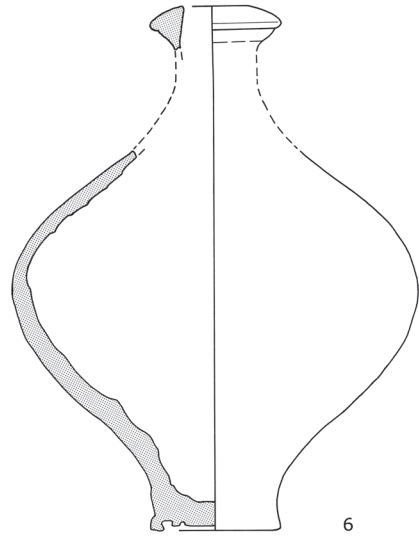

6

Grab 103



Nagel

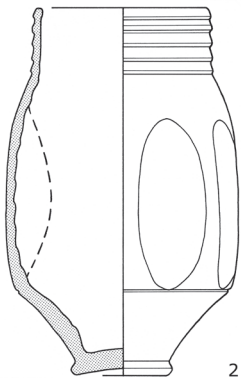

2

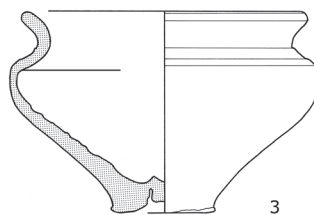

3

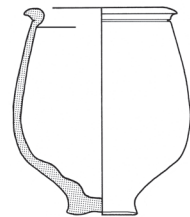

5

Grab 104

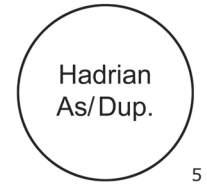
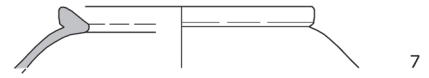
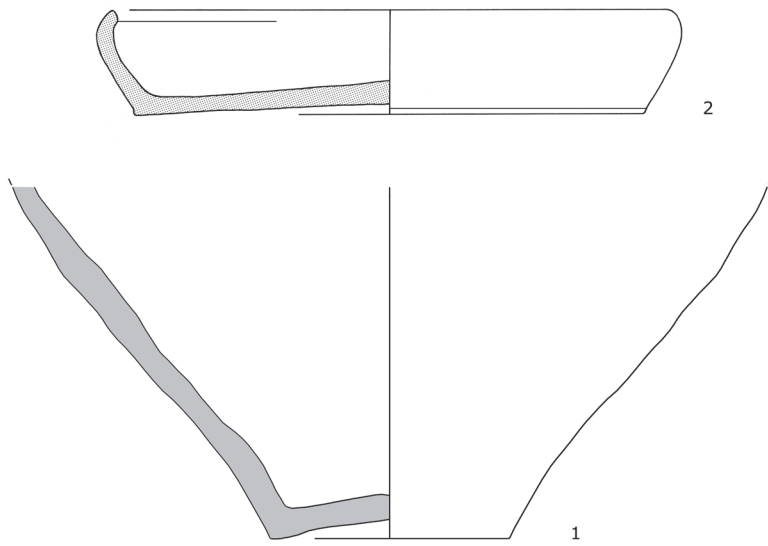

Grab 105



Glas

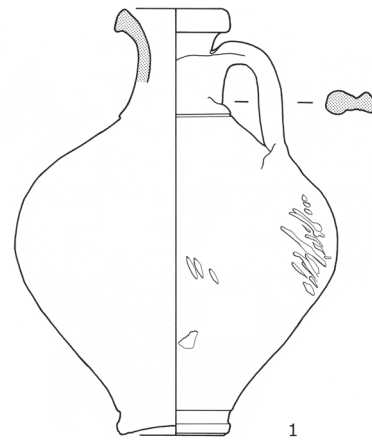
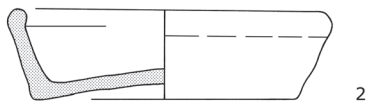

Grab 106



Nagel

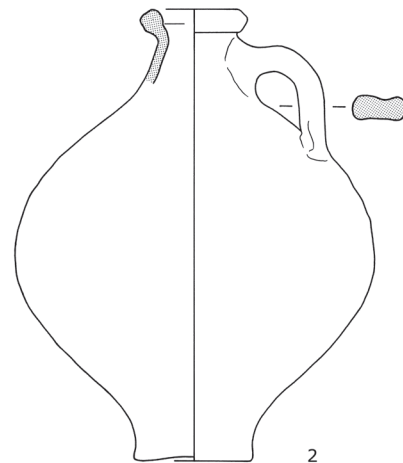
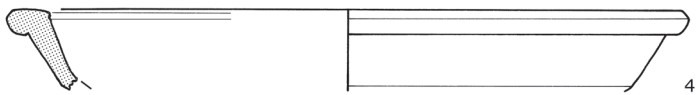
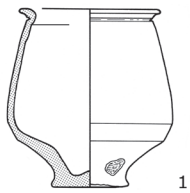

Grab 107

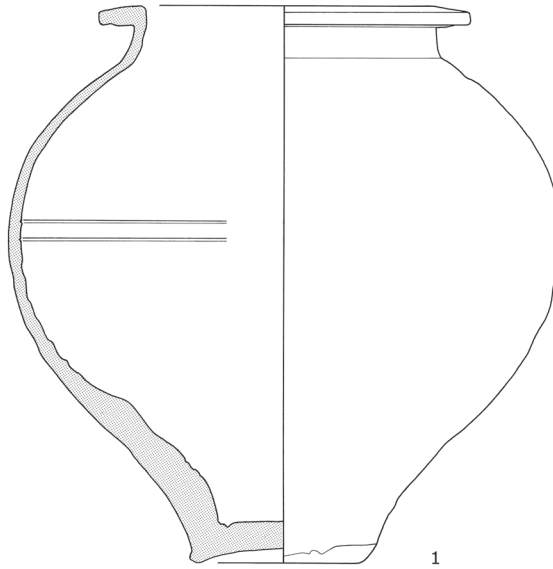

Grab 108

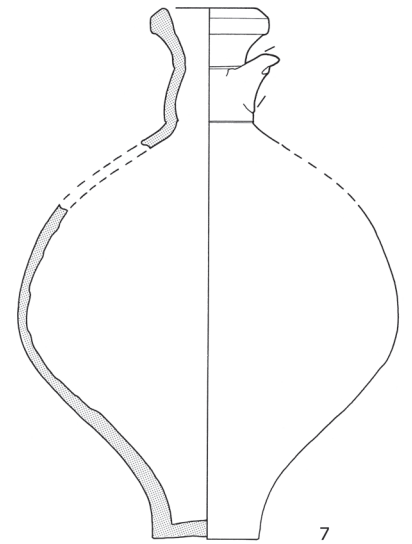
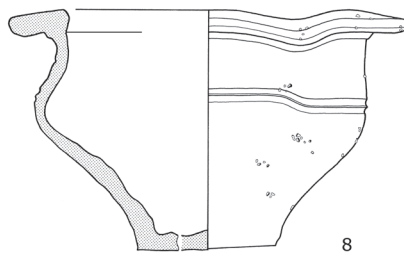
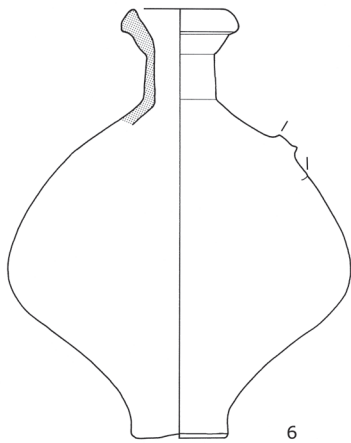
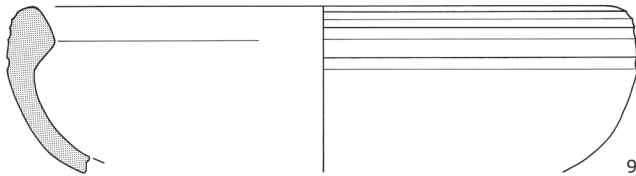

Trajan/
Hadrian
98-138 n.Chr.

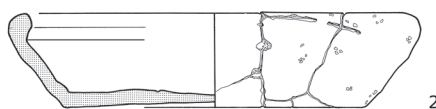
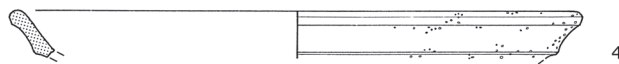

→
Grab 108

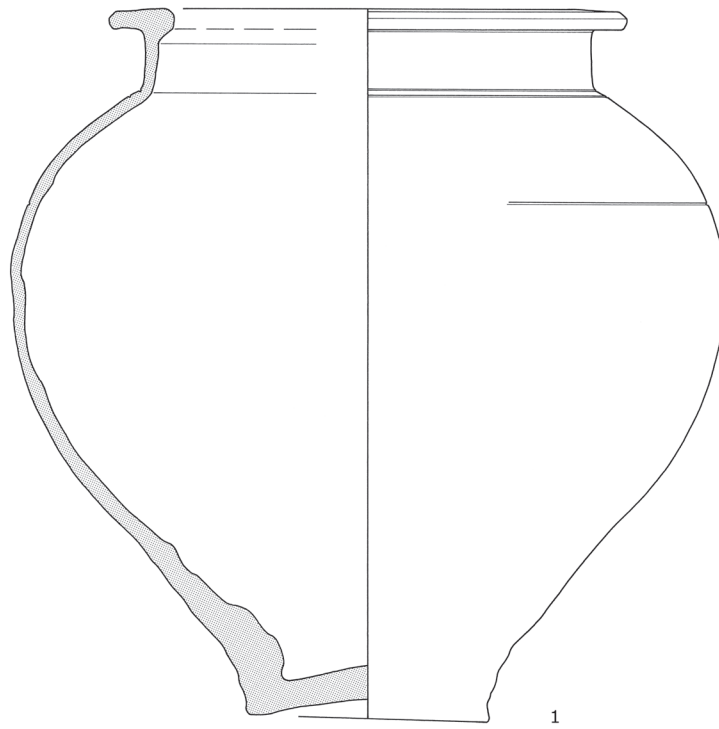

Grab 109



Nägel



Antoninus
Pius
Rom
139 n.Chr.
Sesterz

1

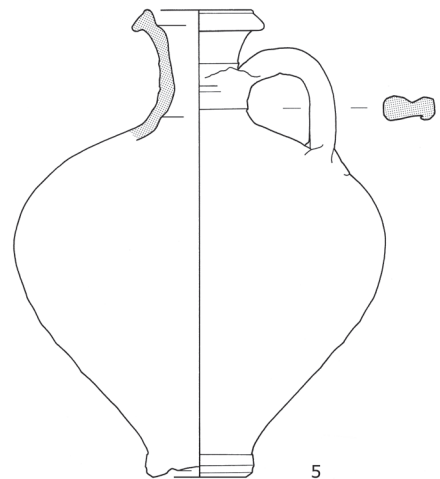
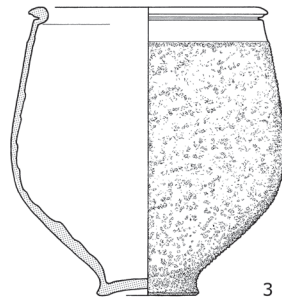
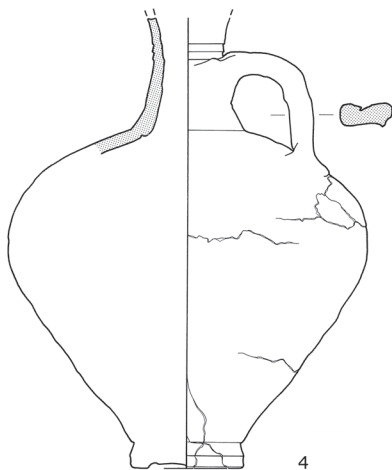

Grab 110



Nägel
Schuhnägel

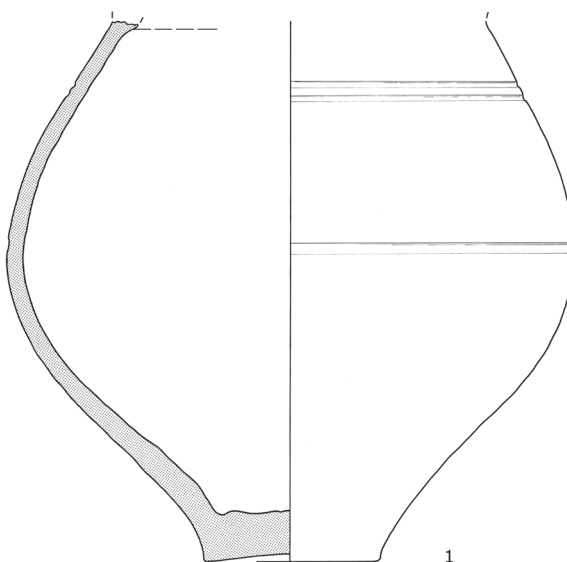
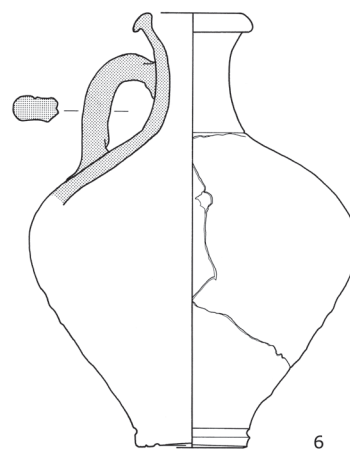
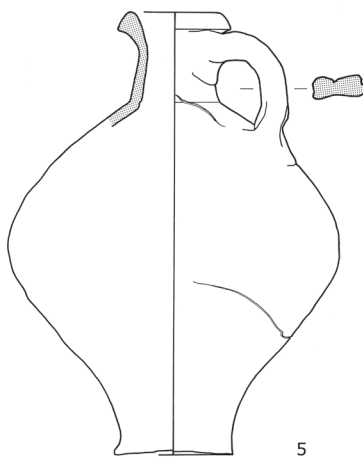
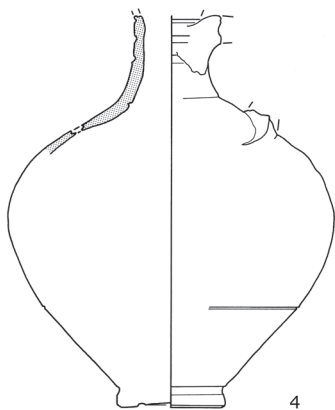
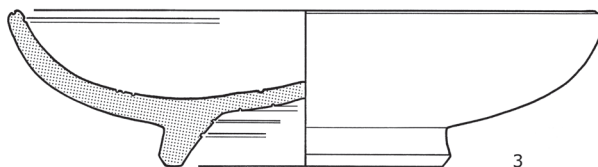

Grab 111



Nägel
Keramik

Grab 112



Nägel

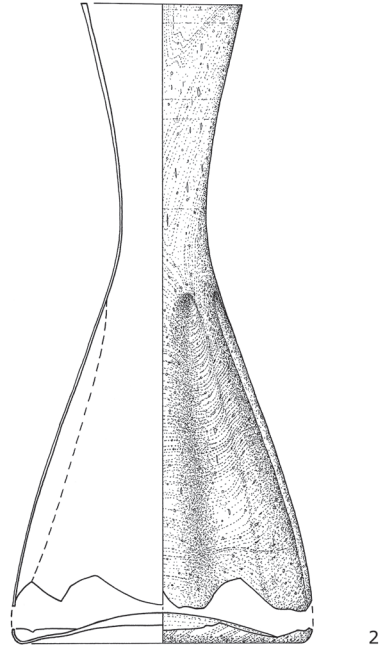
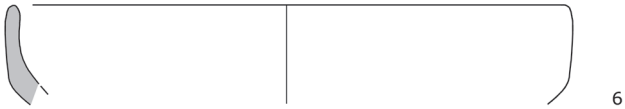

Grab 113



Glas
Nägel

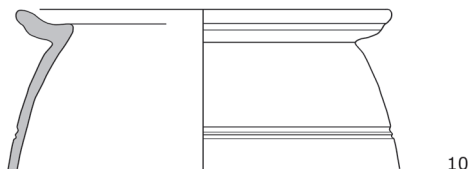
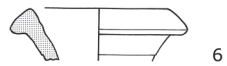
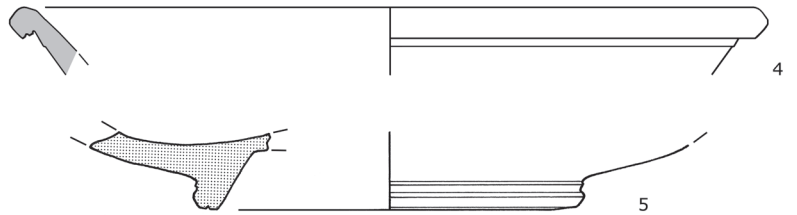
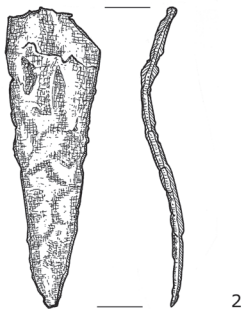

Grab 114

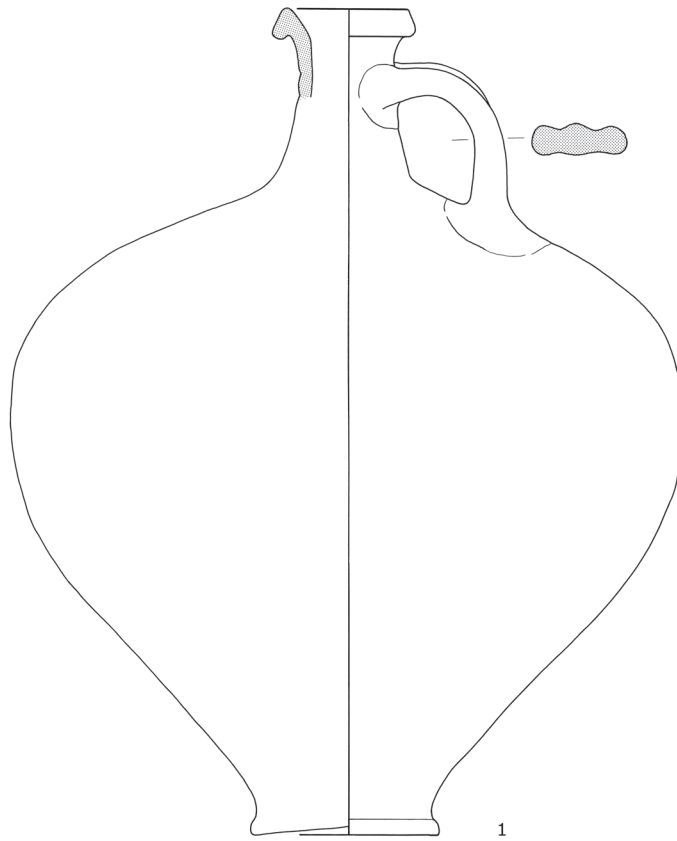

Grab 115

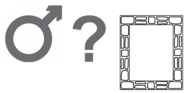

Nägel

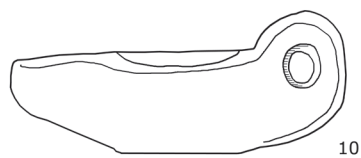
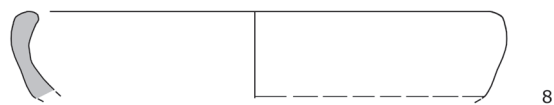
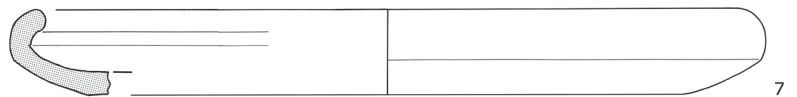
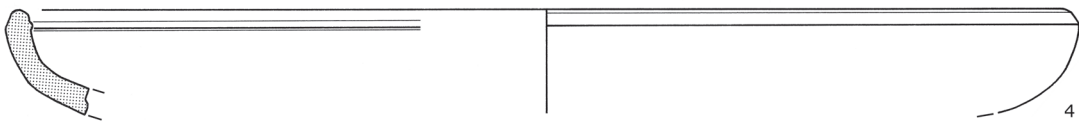
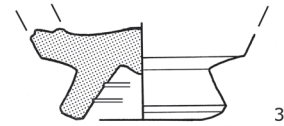
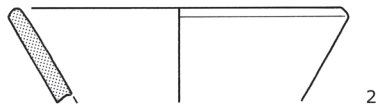

←
Grab 115

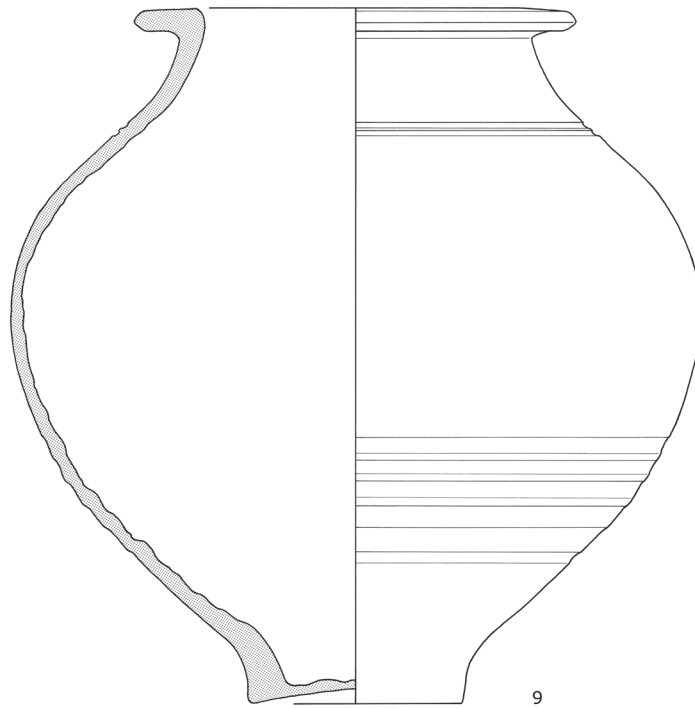

Grab 116



Nägel
Schuhnägel
Bronzeblech

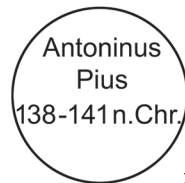

1

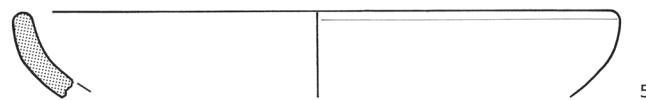
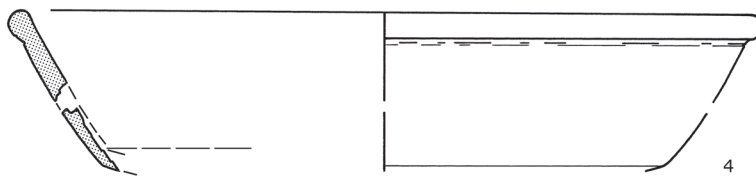

Grab 117



Glas
Nägel



3

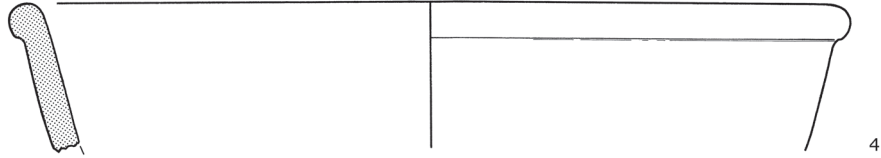

4

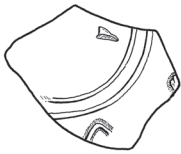
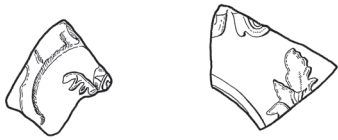

5

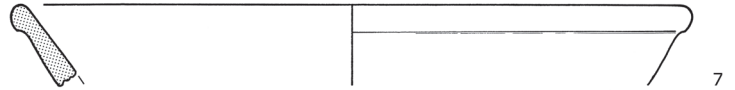

7



8

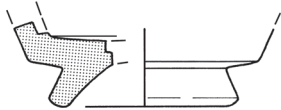

6

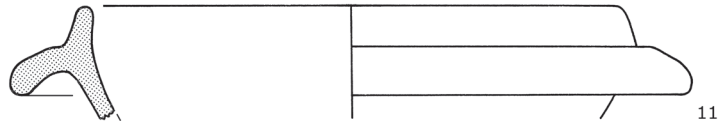

11

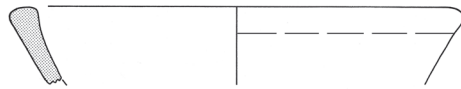

12

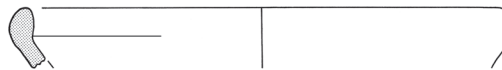

13

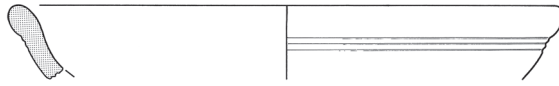

14

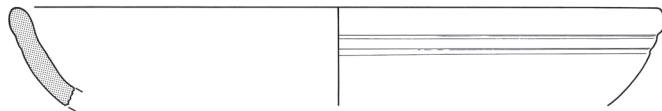

15

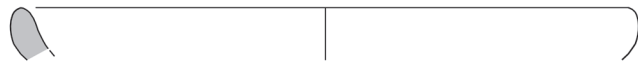

16

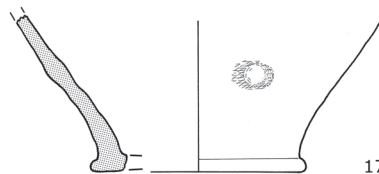

17

Grab 118



Glas
Nagel

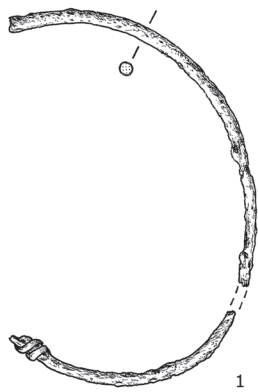

1

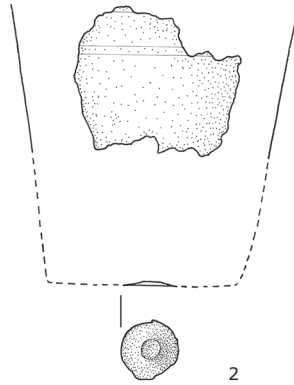

2

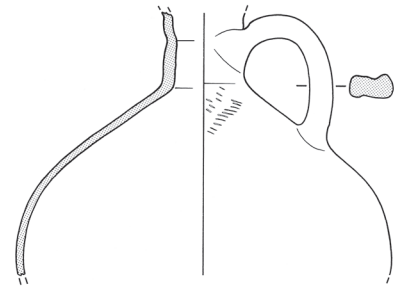

5

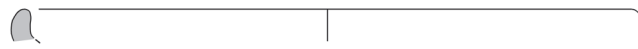

6

Grab 119



Nägel
Sandstein

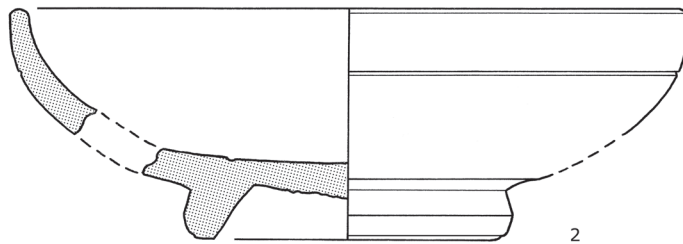

2

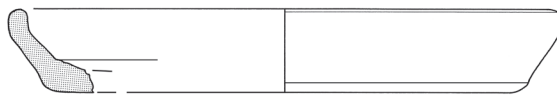

7



8

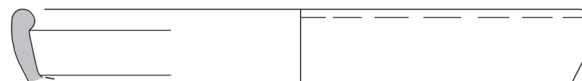

9

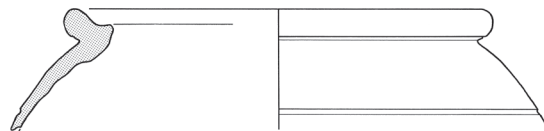

10



11

Grab 120



Ziernagel



Hadrian
2.Jh.n.Chr.

2

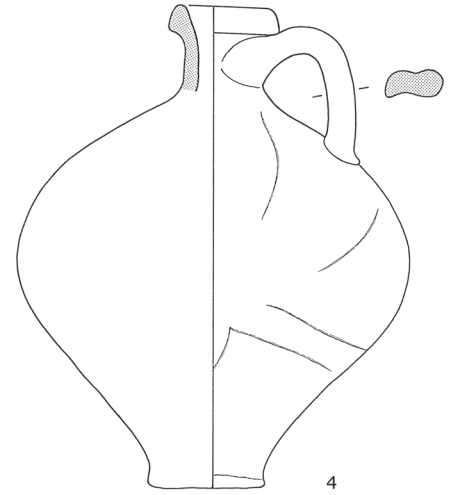
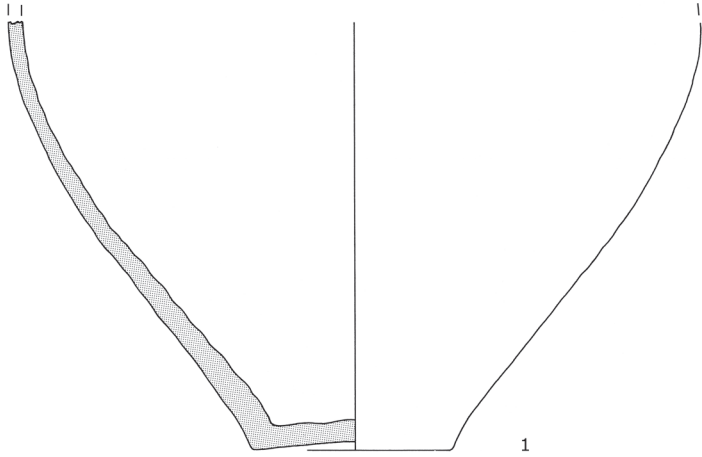

Grab 121

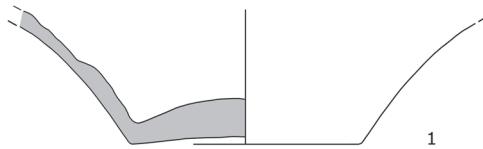

Grab 122

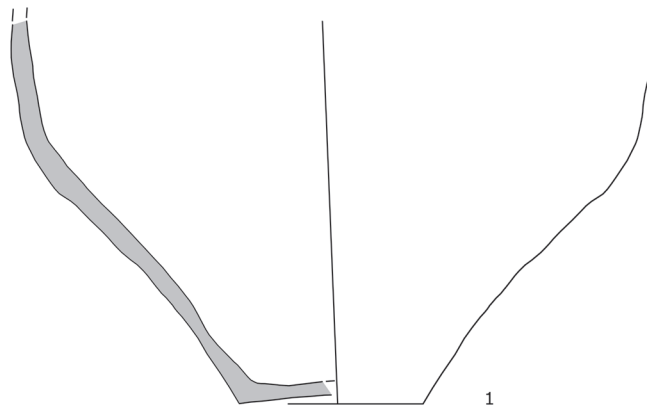
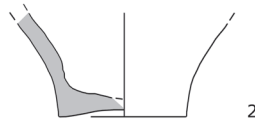

Grab 123

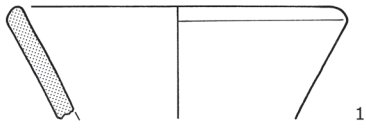

1

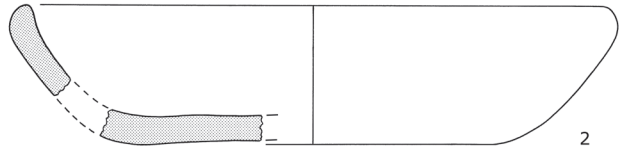

2

Grab 124

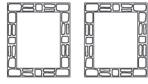

Glas

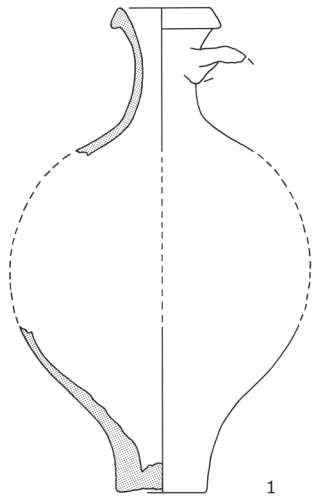

1

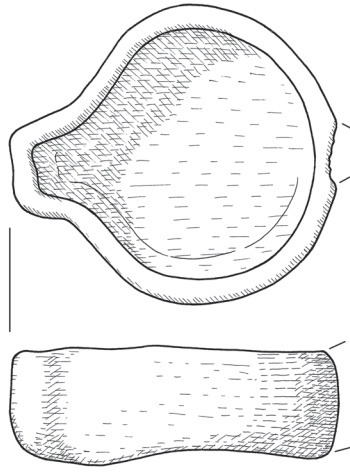

4

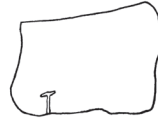

7

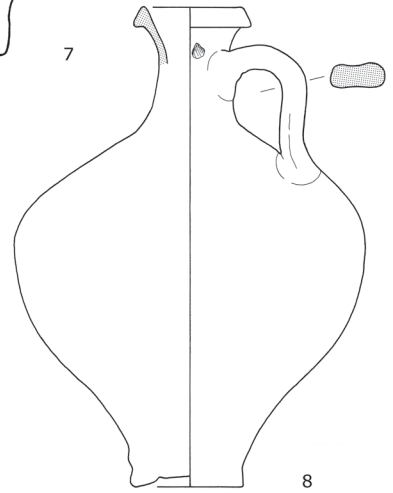

8

Grab 125



Nägel

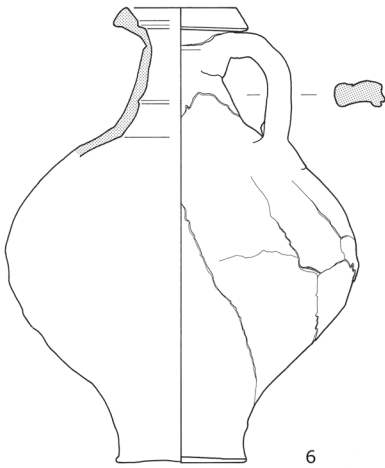

6



4

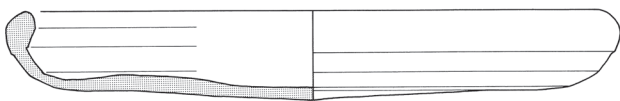

2

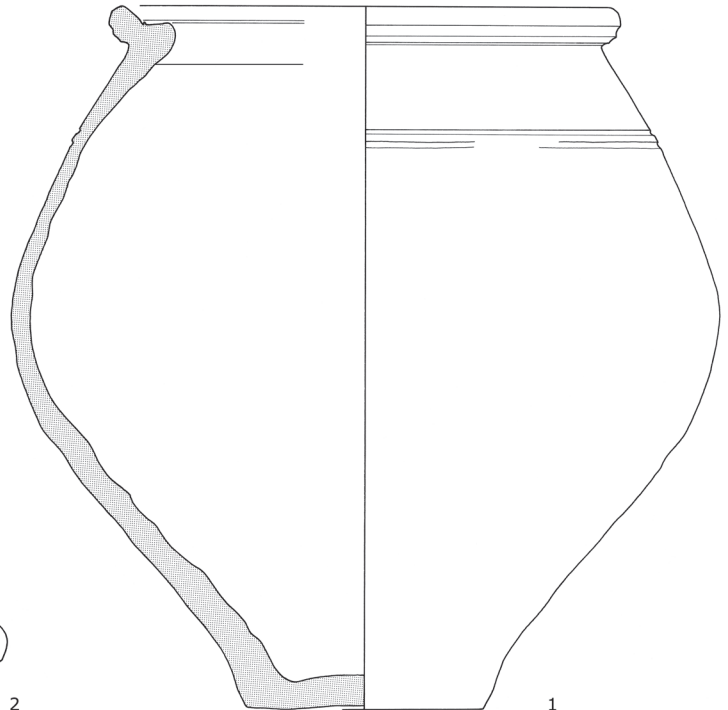

1

Grab 126

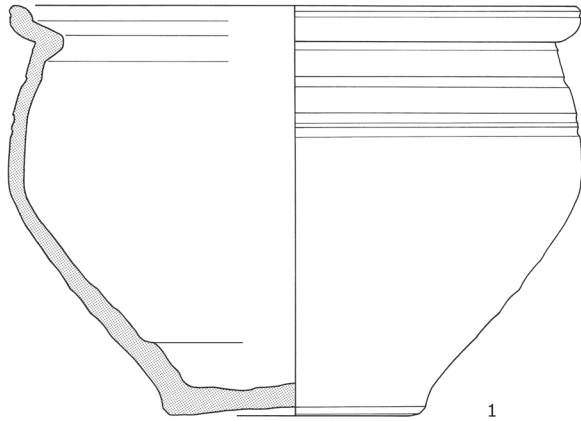

1

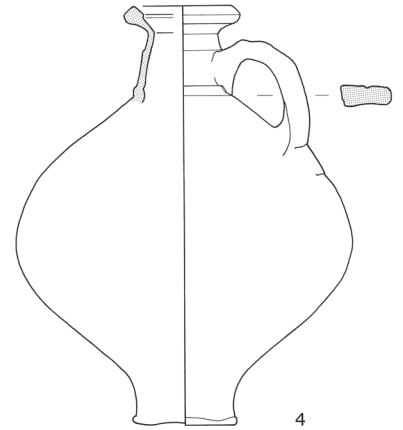

4

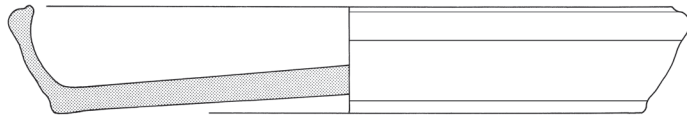

2

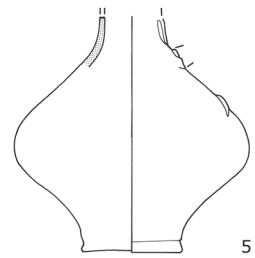

5

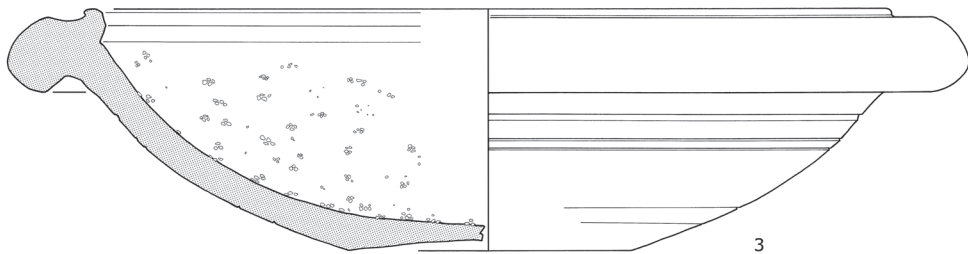

3

Bereich 125/126



Nägel
Sandstein

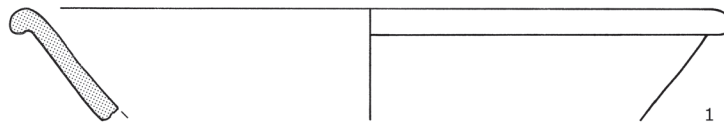

1



2

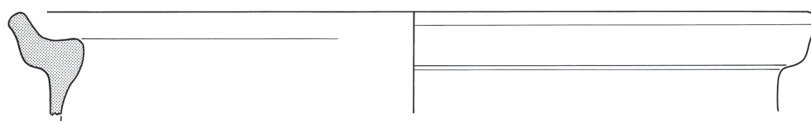

5



6

← Bereich 125/126

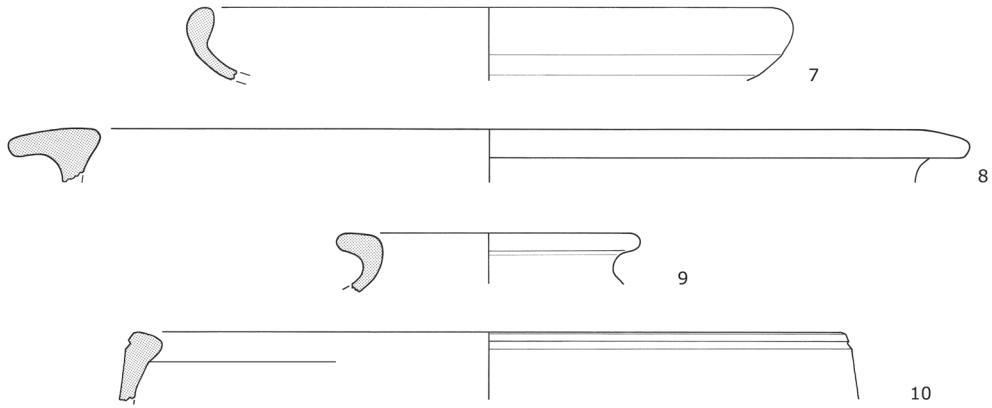

Grab 127



Nägel
Eisenbeschlag

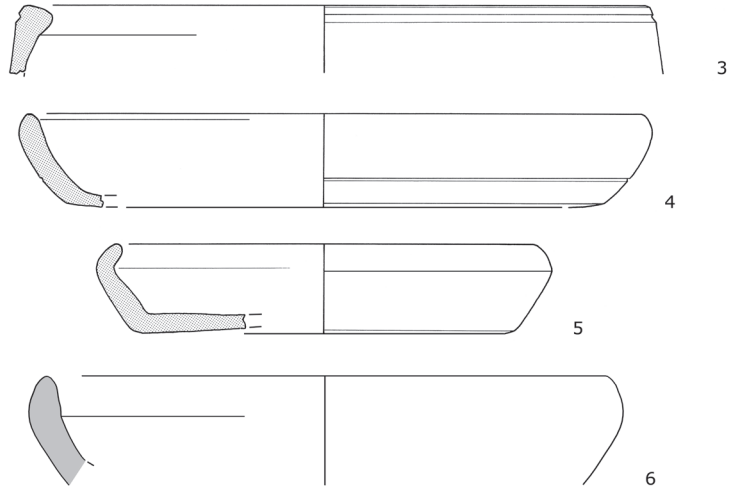

Grab 128

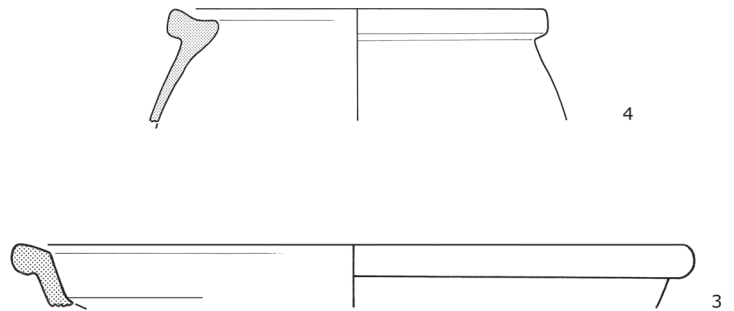
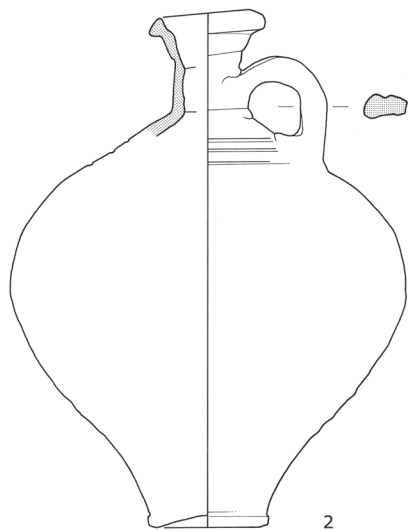

← Grab 128

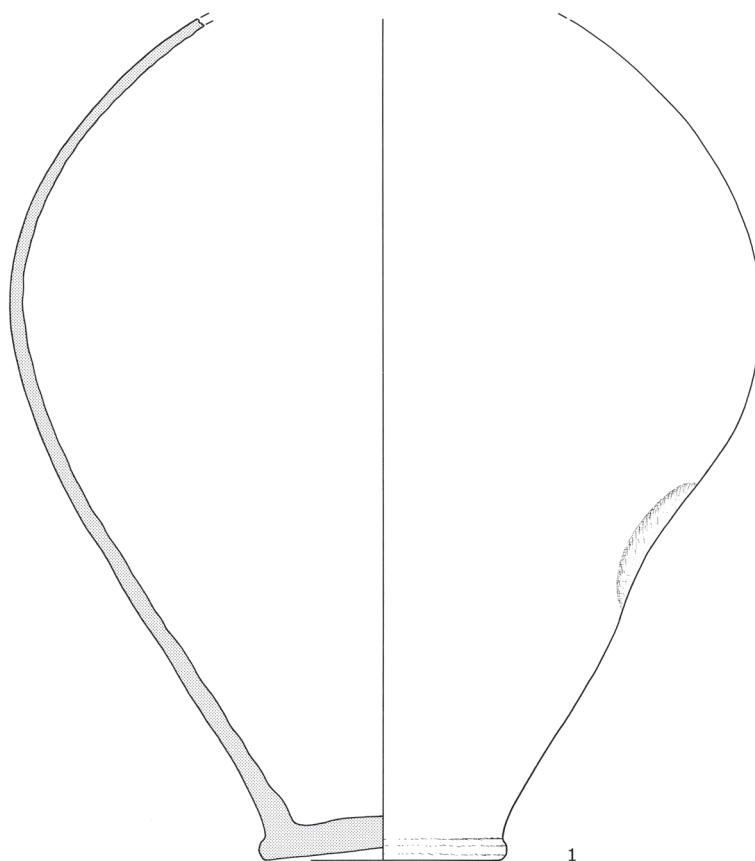

Grab 129



Bronzerest

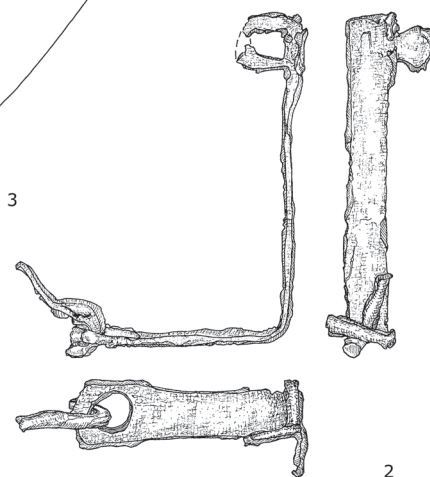
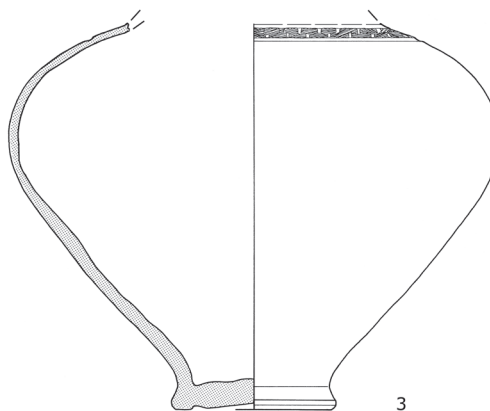
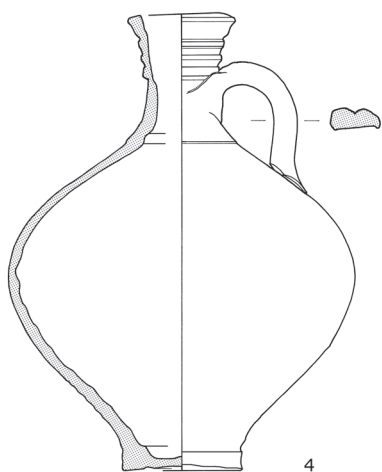

Bereich 128/129



Nägel
Schuhnägel

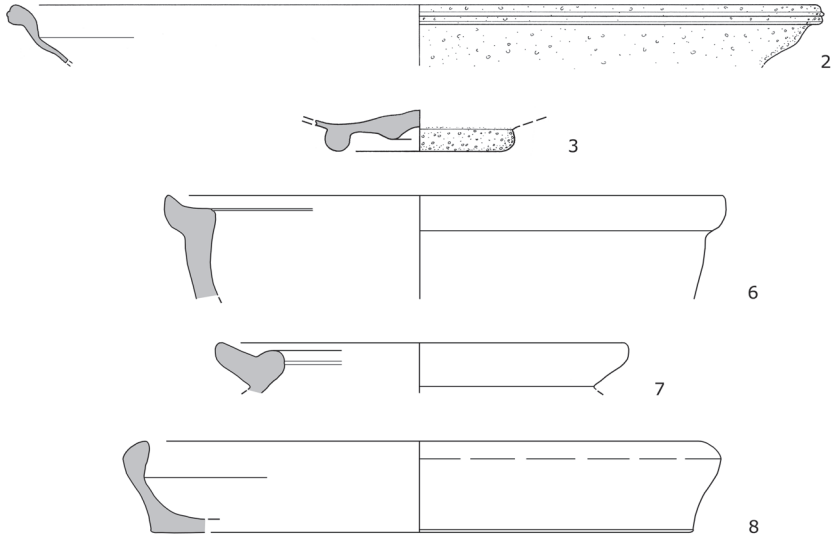

Grab 130



Nagel
Sandstein

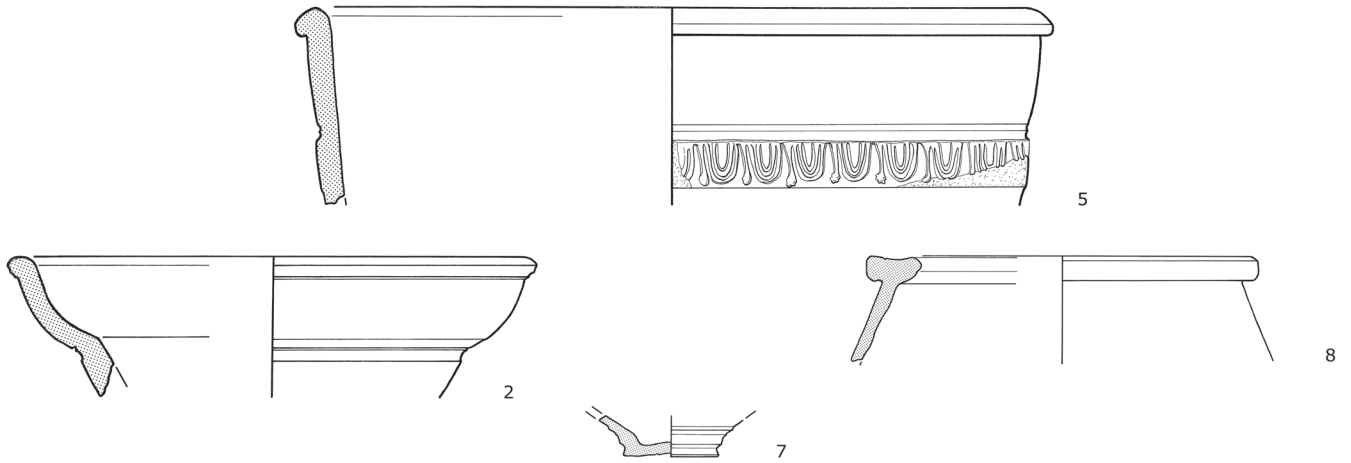

Grab 131

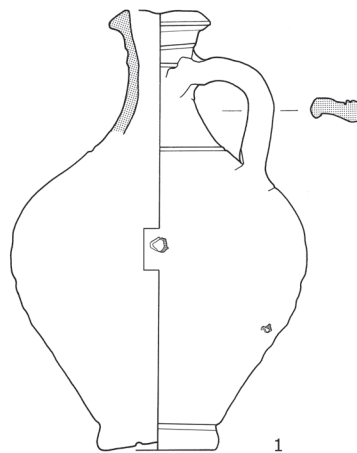

Grab 132

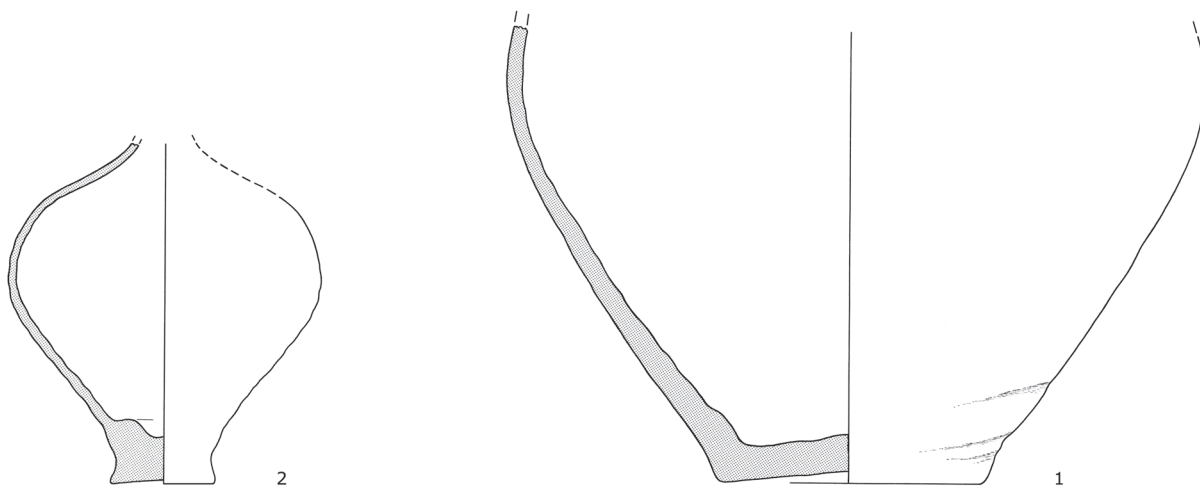

Grab 133

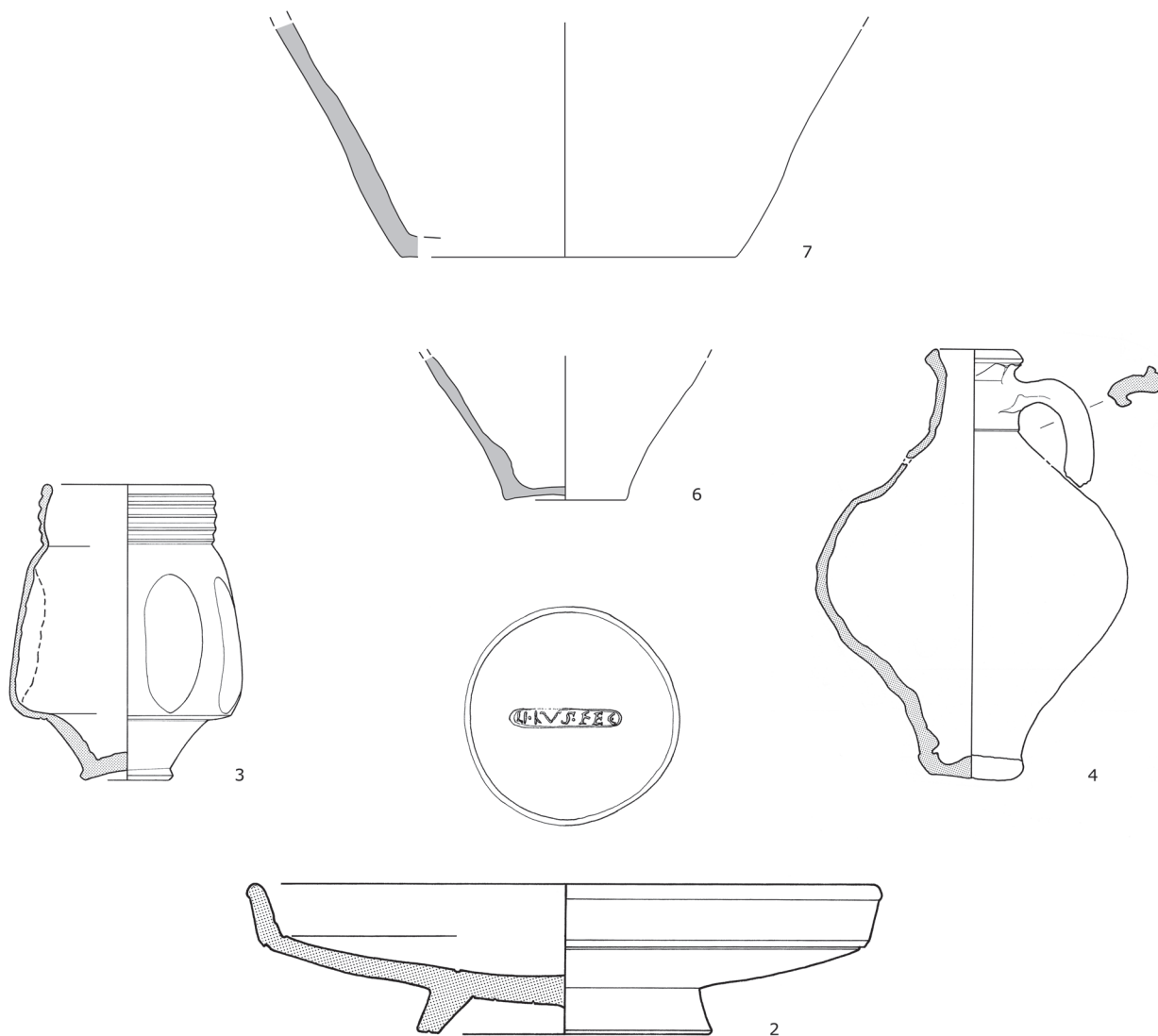

← Grab 133

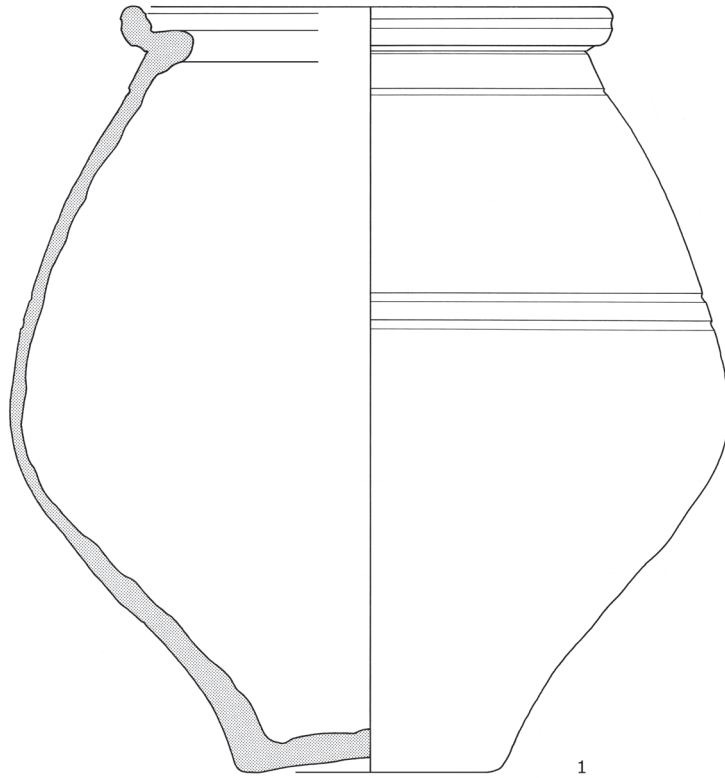

Grab 134



Keramik

→ Grab 135



Nägel
Schuhnagel

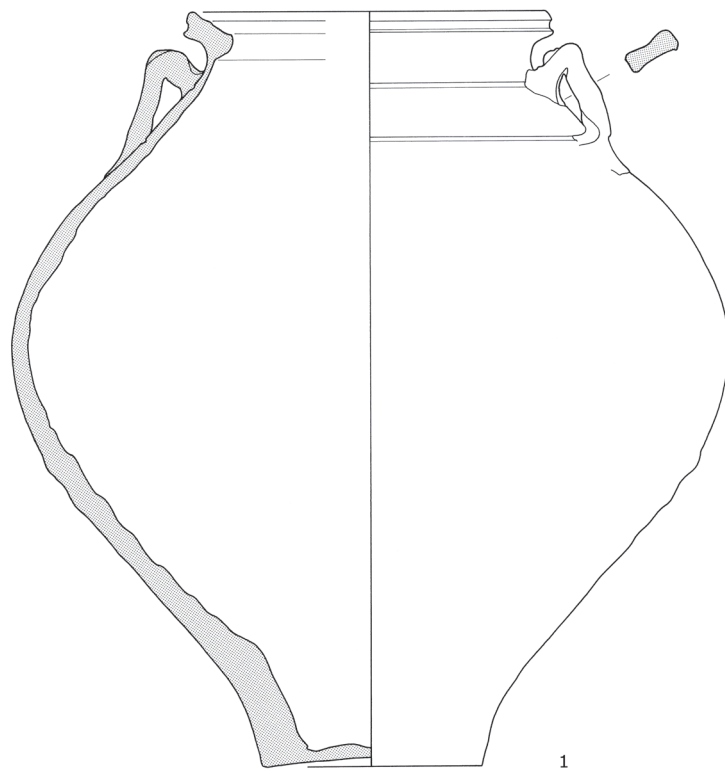

Grab 135

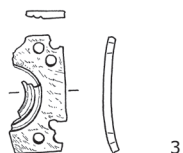
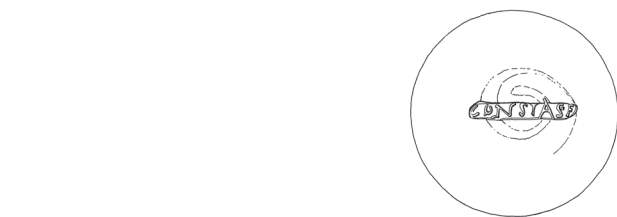

3

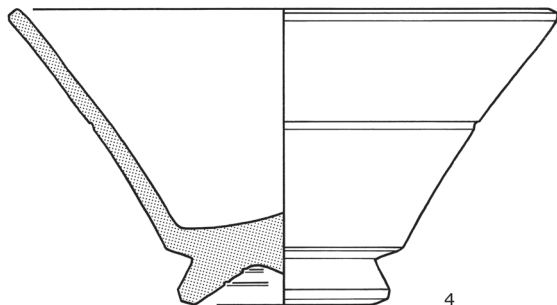

4

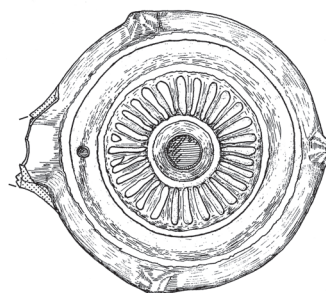

6

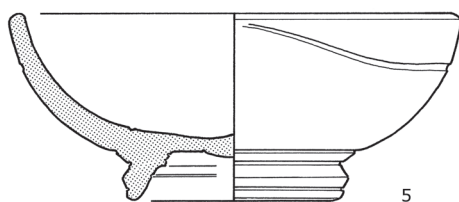

5

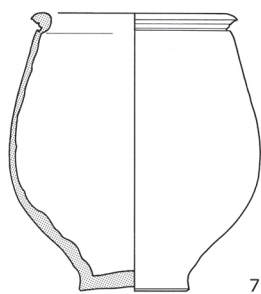
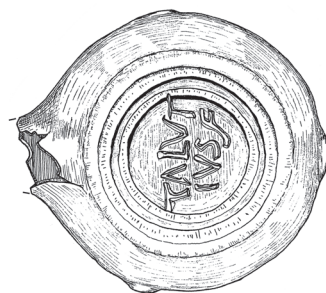

7

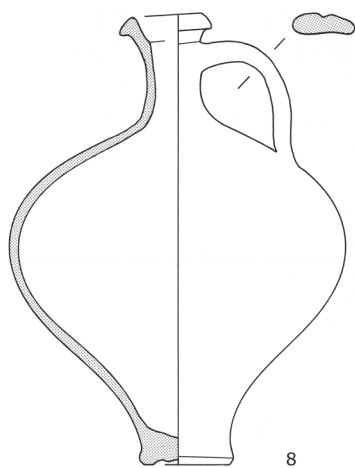

8

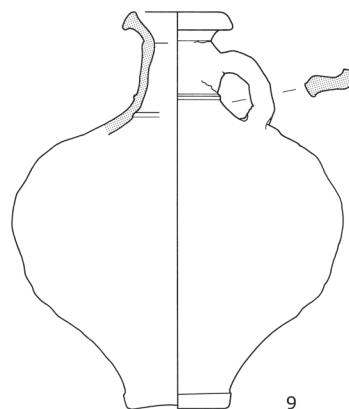

9

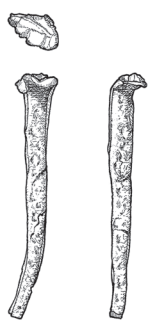

12

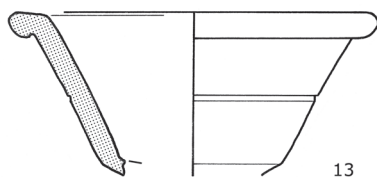

13

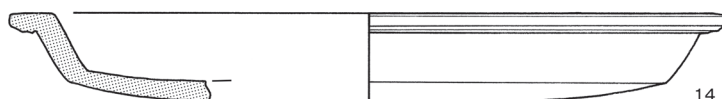

14

Grab 136

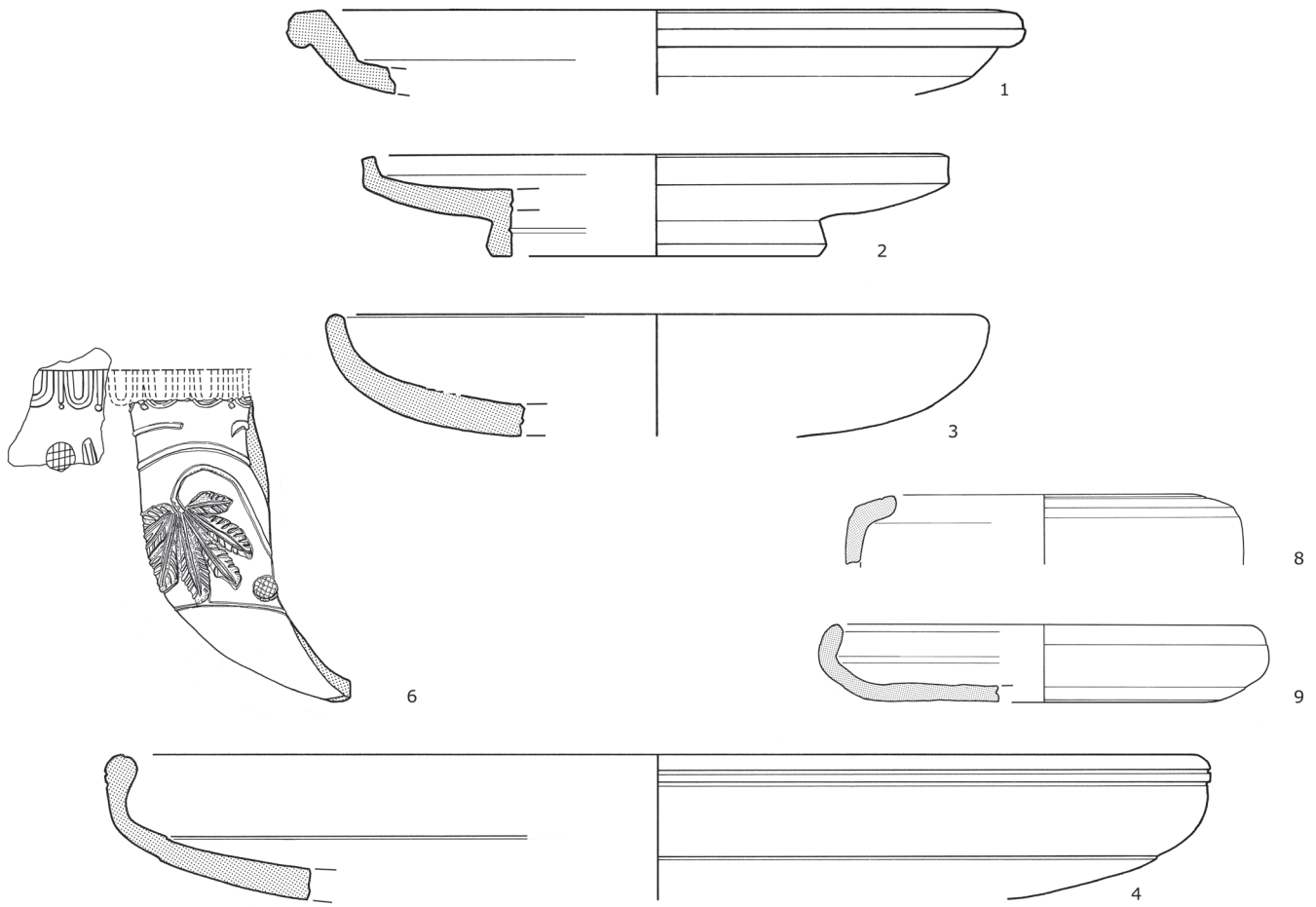

Grab 137



Nägel

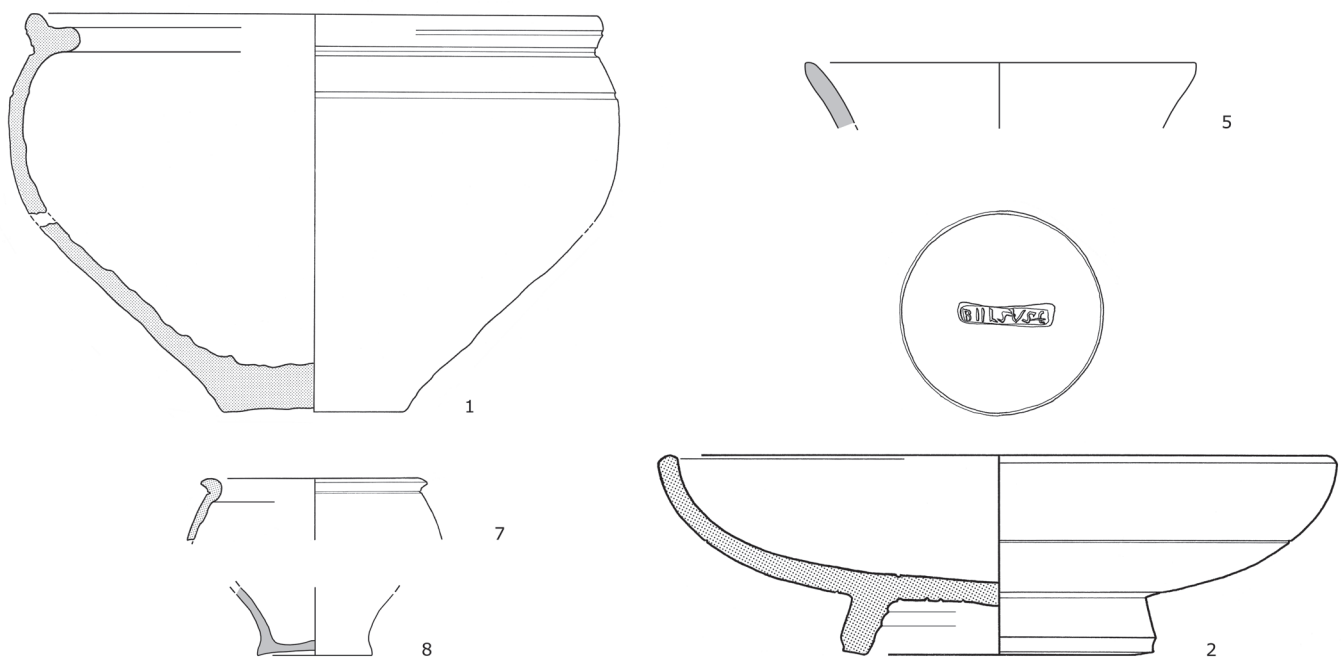

Fundstelle 138



Nagel

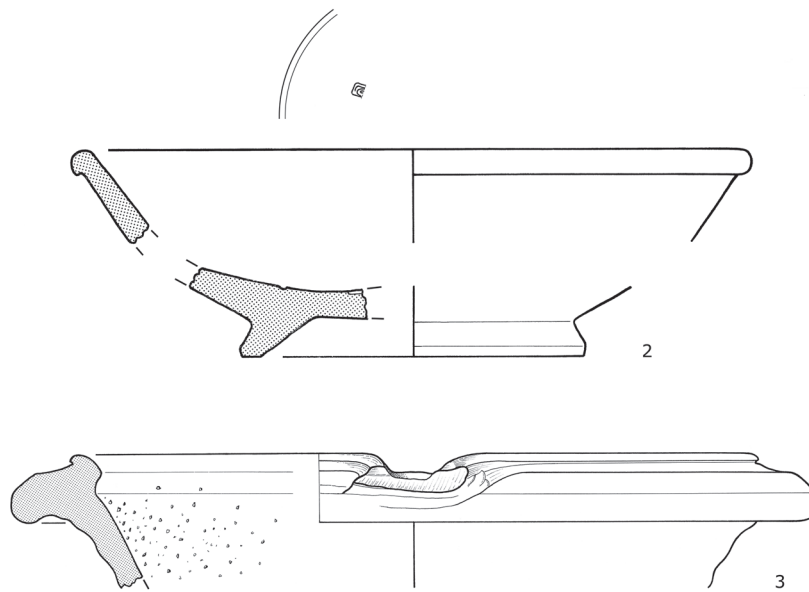

Grab 139



Ziegel

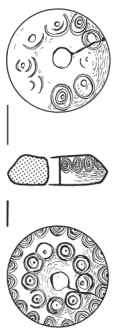

2

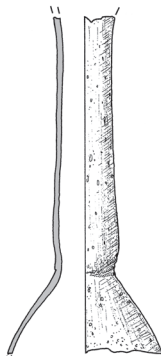

4

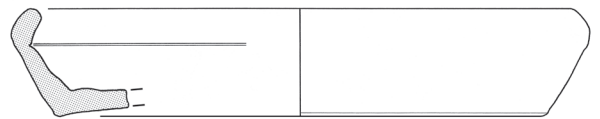

5



6



7

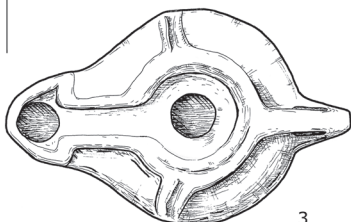
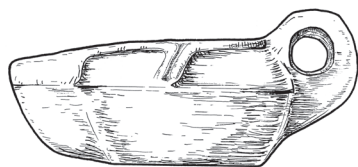

3

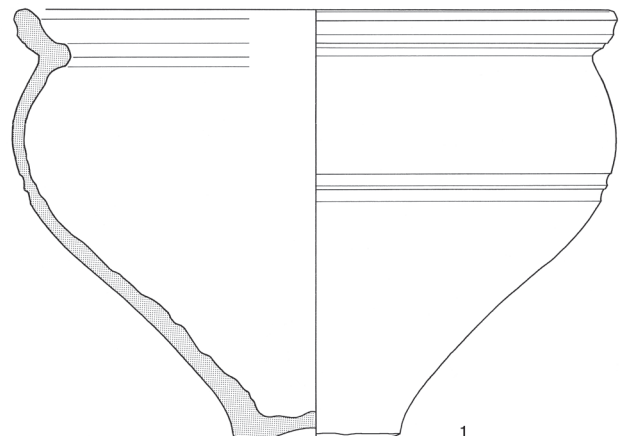

1

Grab 140



Nägel
Bronzeblech
Schuhnagel

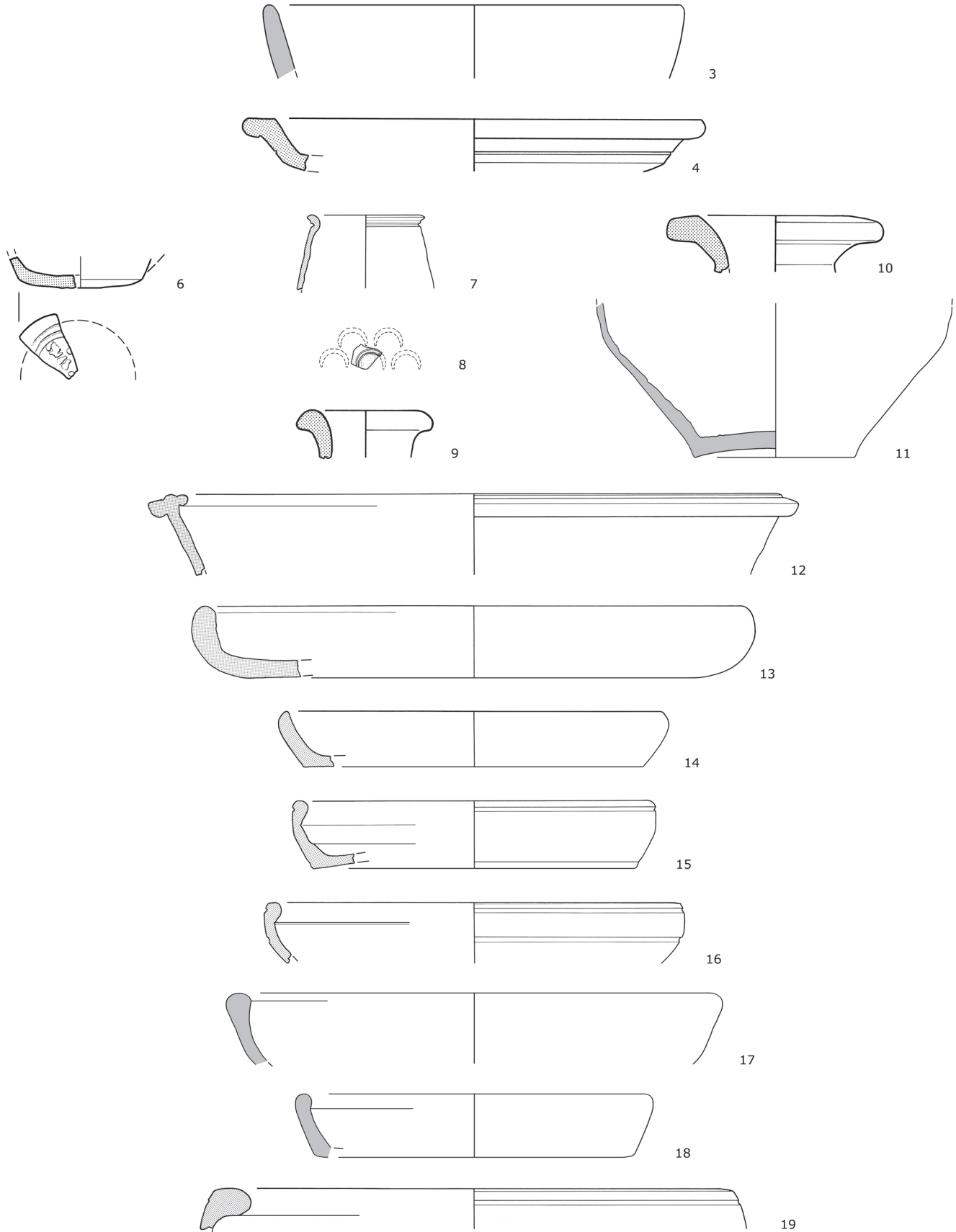

Grab 141



Glas
Tegula



2

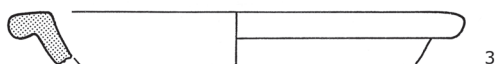

3

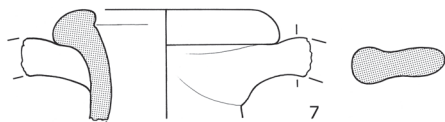

7

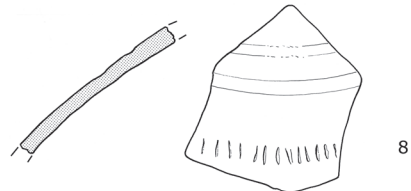

8

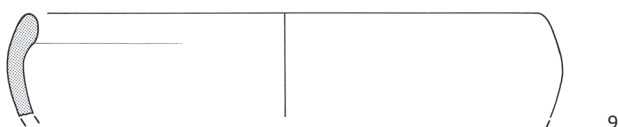

9

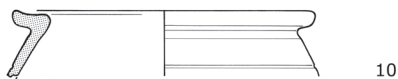

10



12

Grab 142



Nägel

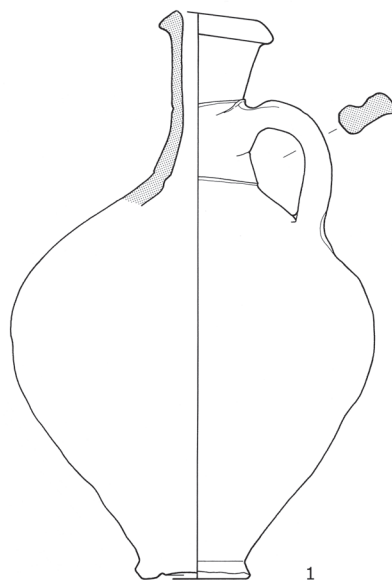

1

Grab 143



Keramik
Ziegel



Grab 144



Glas
Nägel
Schuhnägel



Hadrian
132-134n. Chr.

1

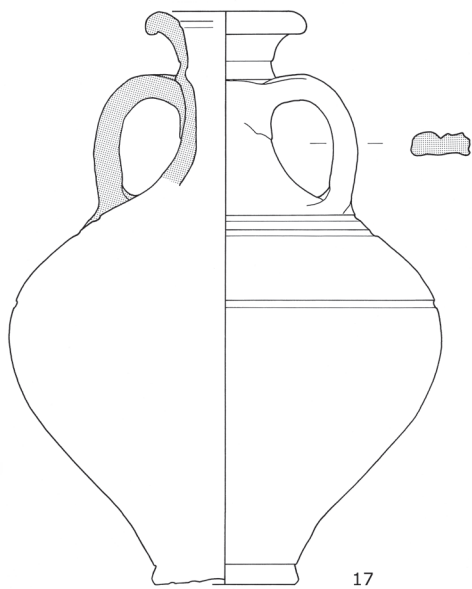
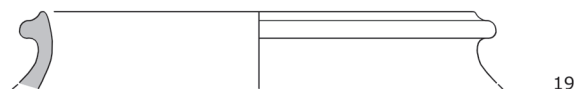
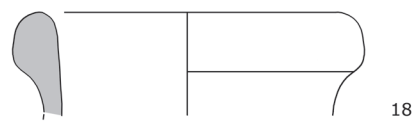
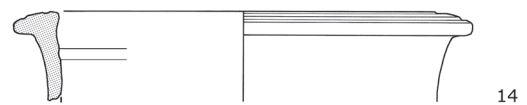
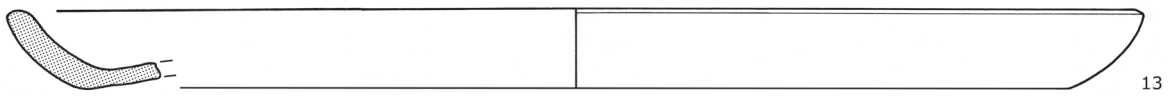
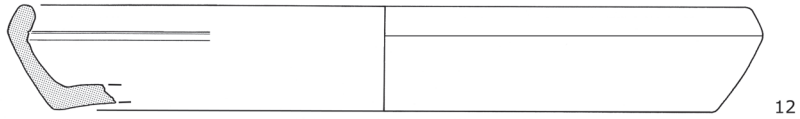
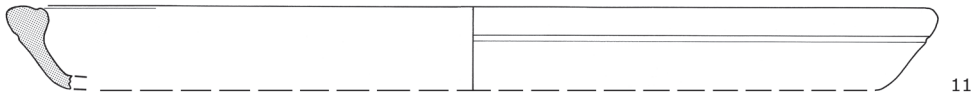
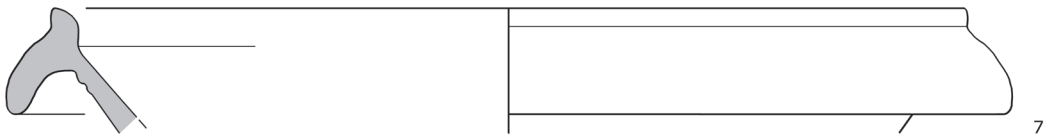
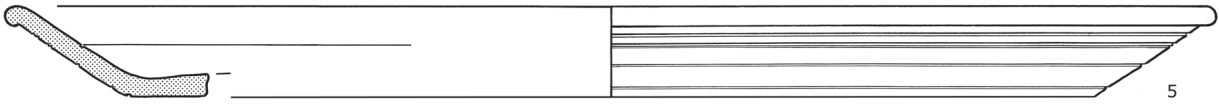

Grab 145



Nägel

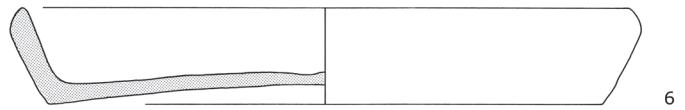
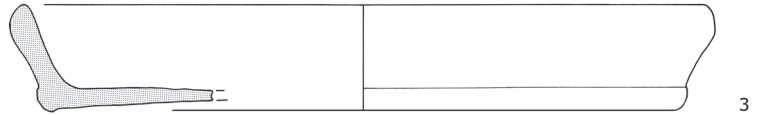
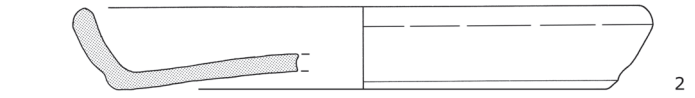
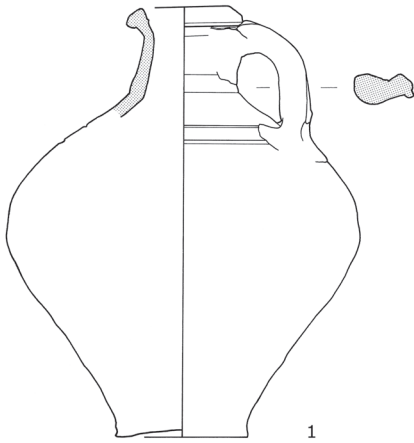

Grab 146



Glas
Nägel

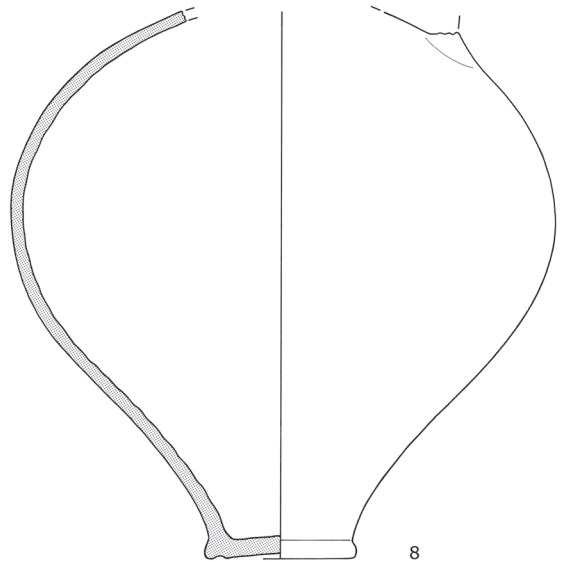
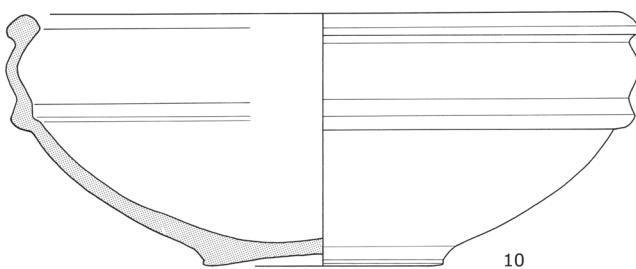
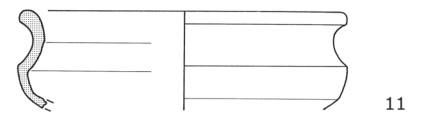
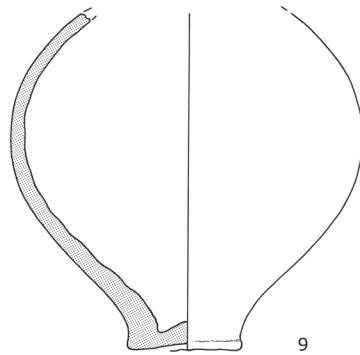
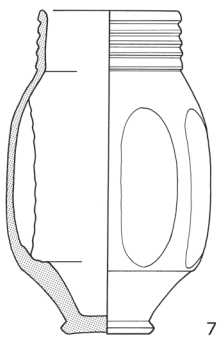
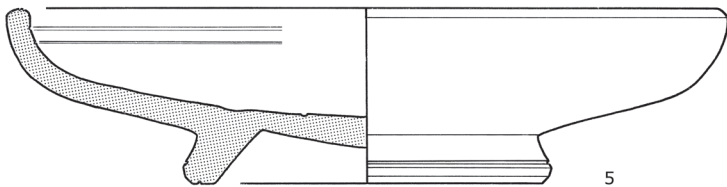
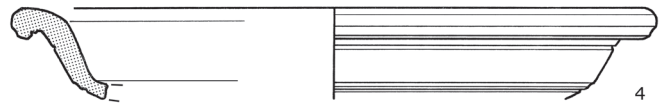

Grab 147

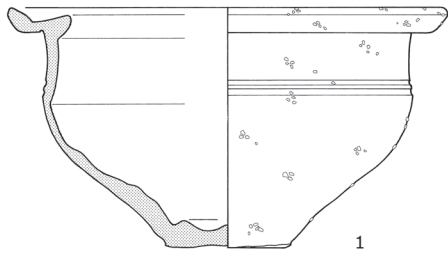

1

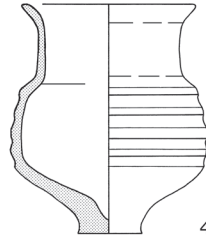

4

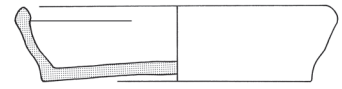

2

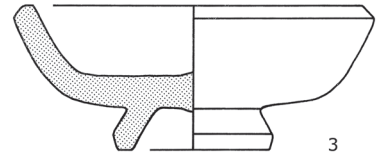

3

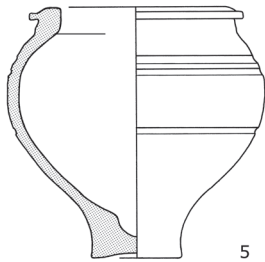

5

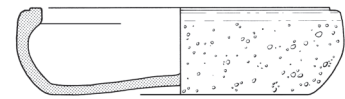

6

Grab 148



2



4

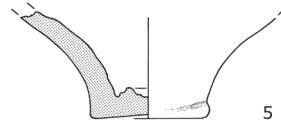

5

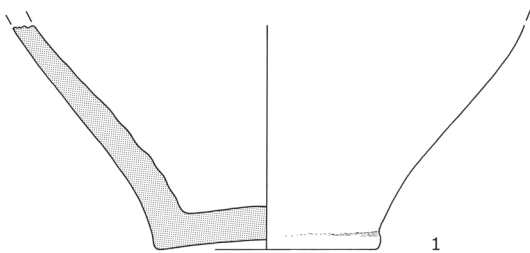

1

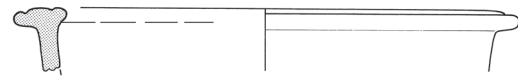

6

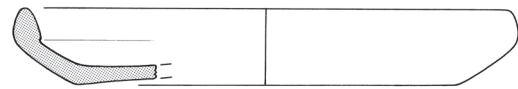

7

Grab 149



Schuhnagel

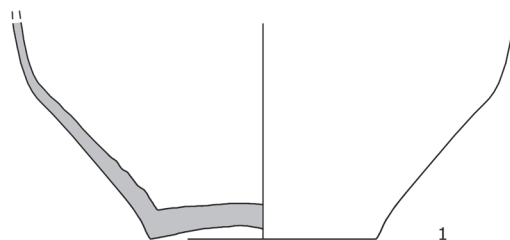

1

Grab 150



Nägel
Bronzeschlacke
Sandstein

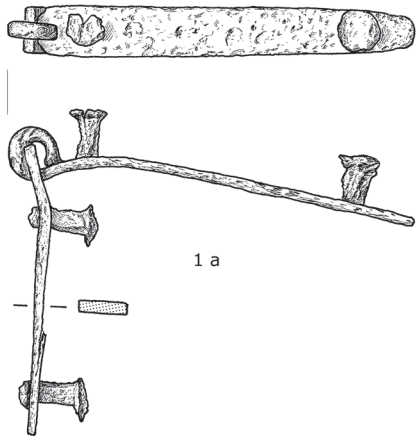

1 a

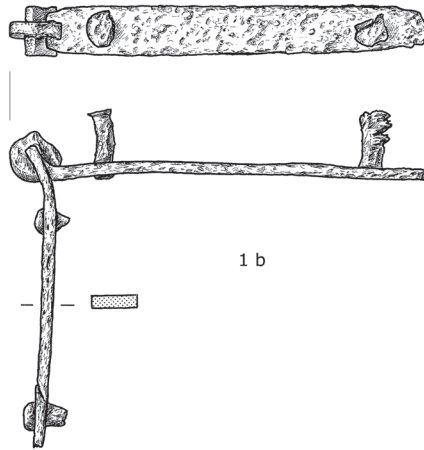

1 b

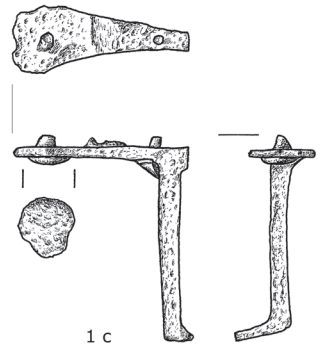

1 c



1 d

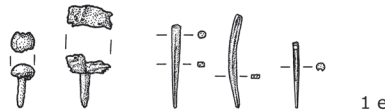

1 e

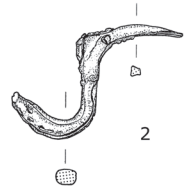

2

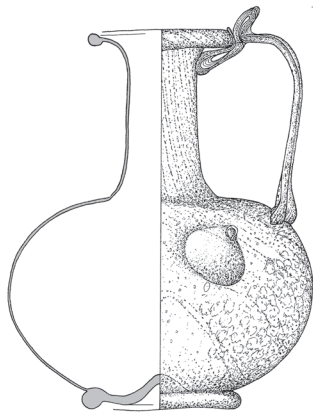

4

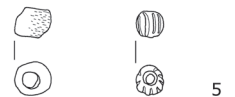
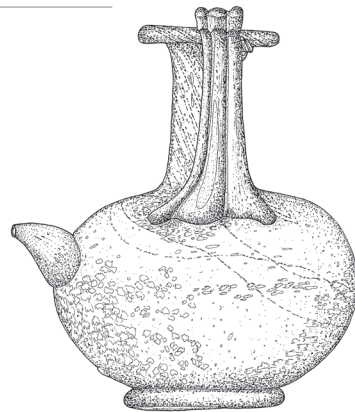

5

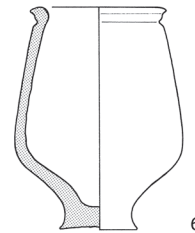

6

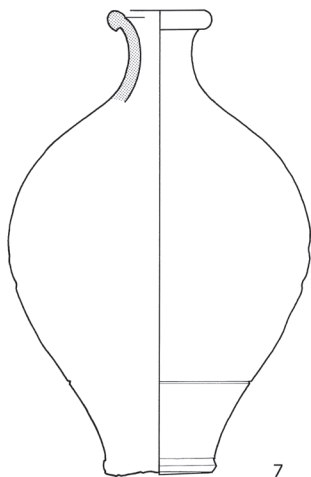

7

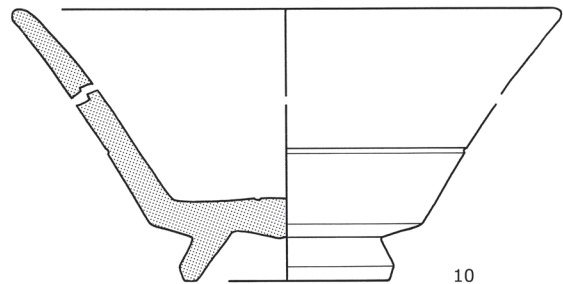

10

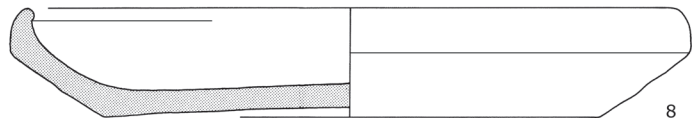

8

← Grab 150

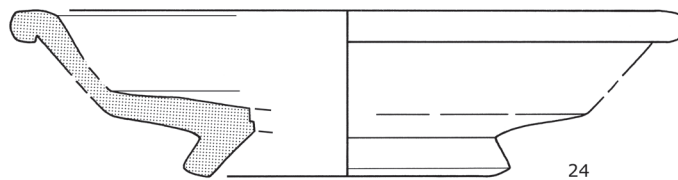
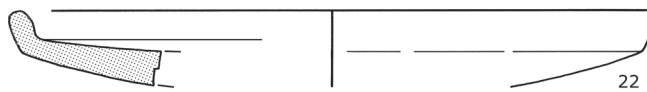
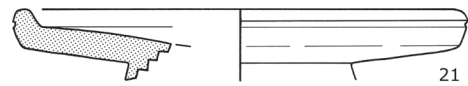
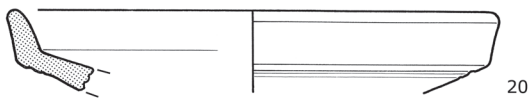
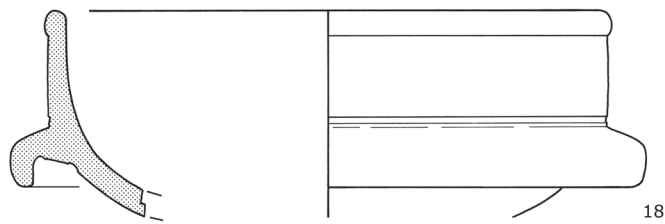
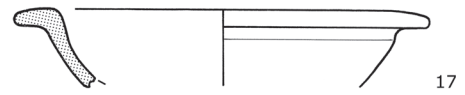
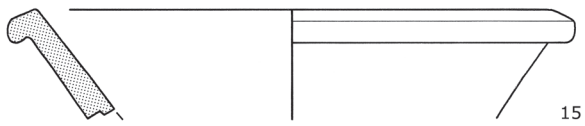
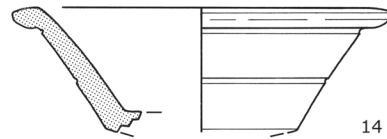
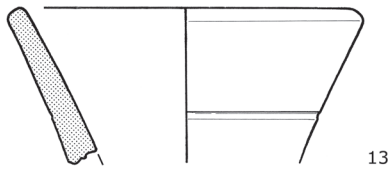
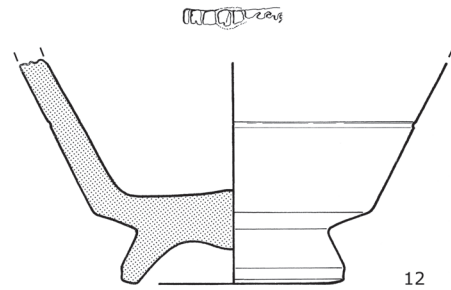
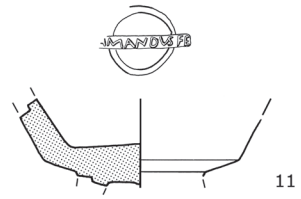
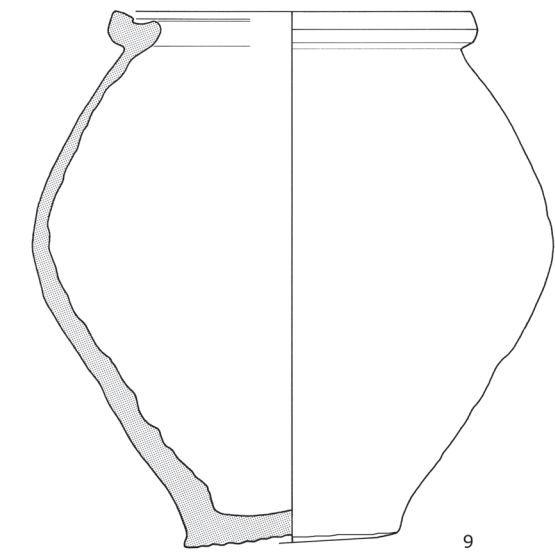

Grab 150

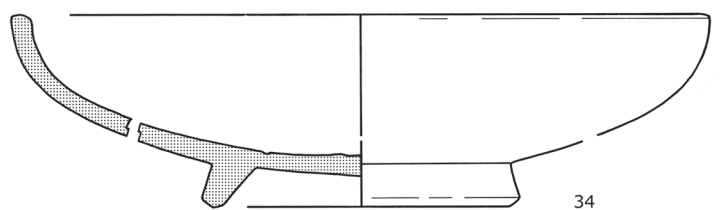
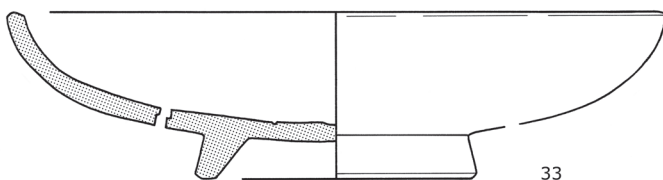
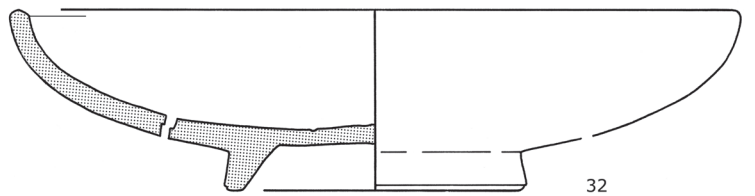
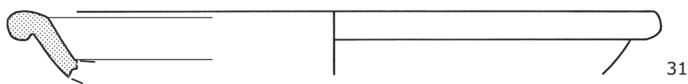
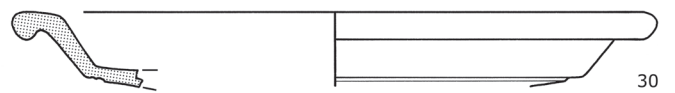
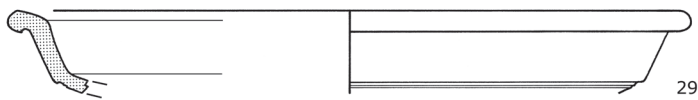
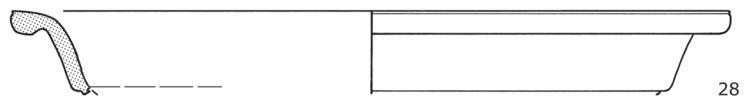
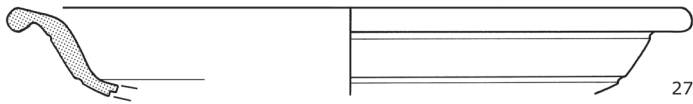
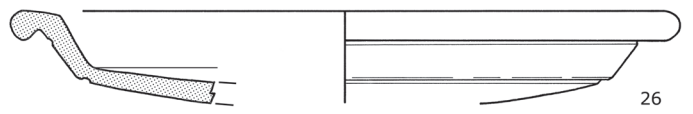
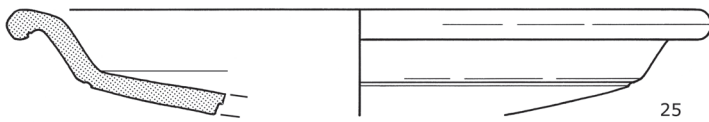

Grab 150

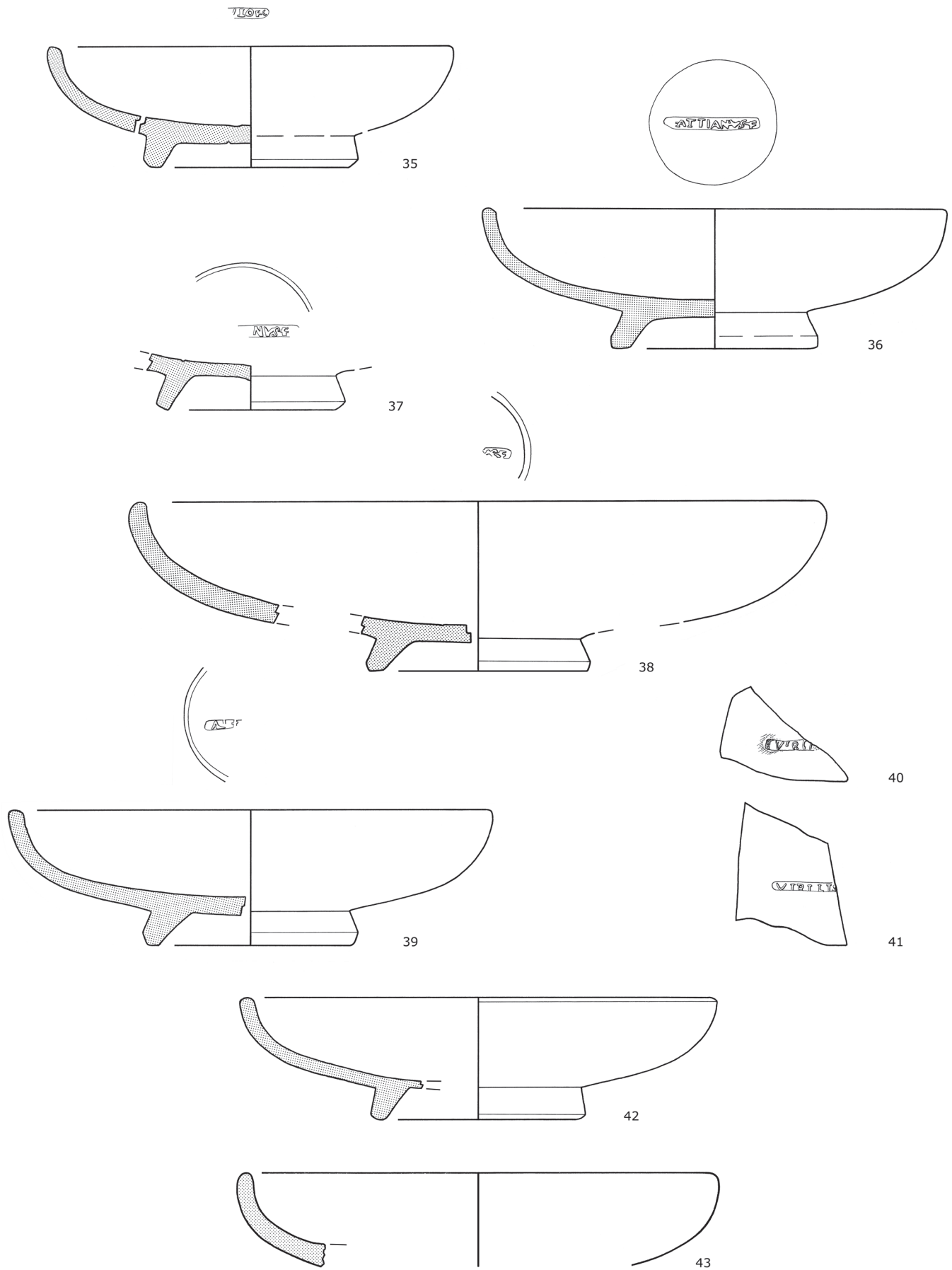

Grab 150

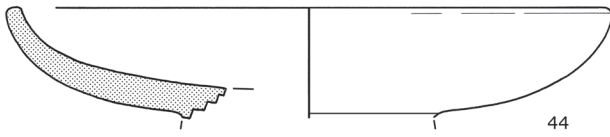

44

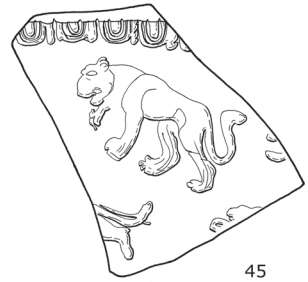

45

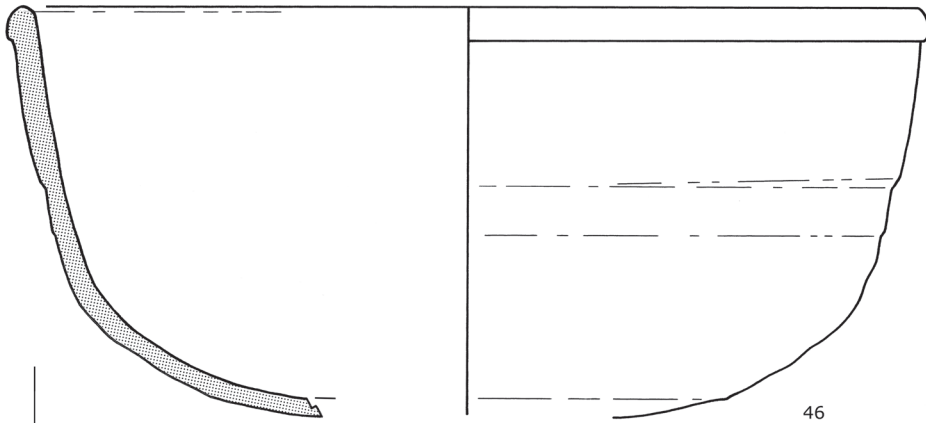

46

Fries
s.u.

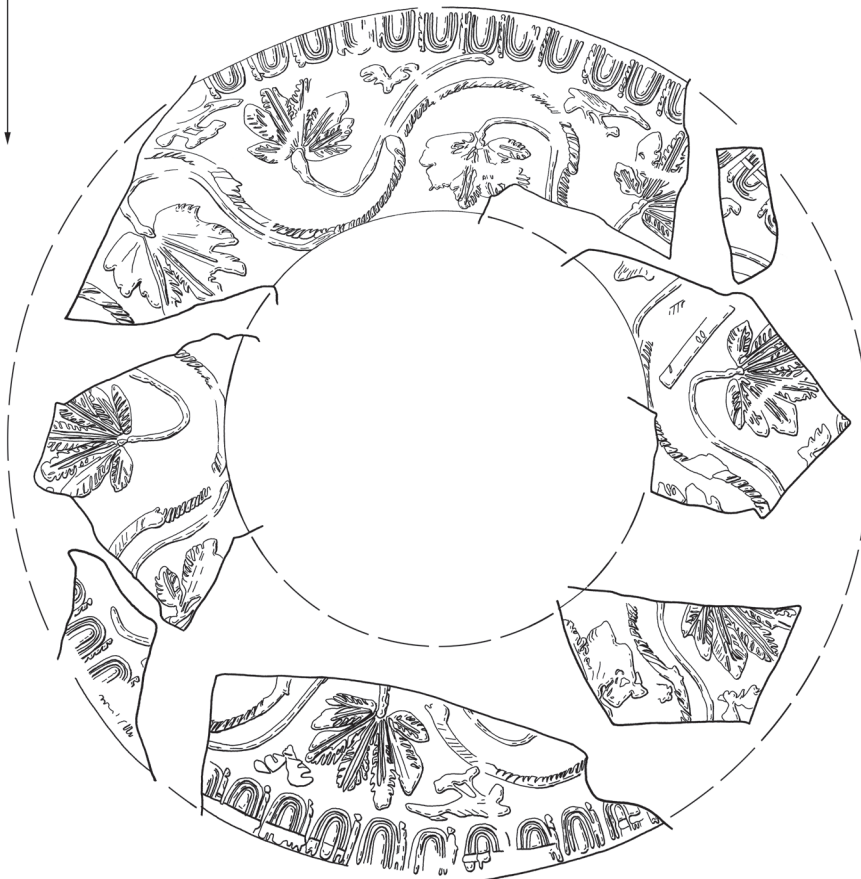

←←←←←
Grab 150

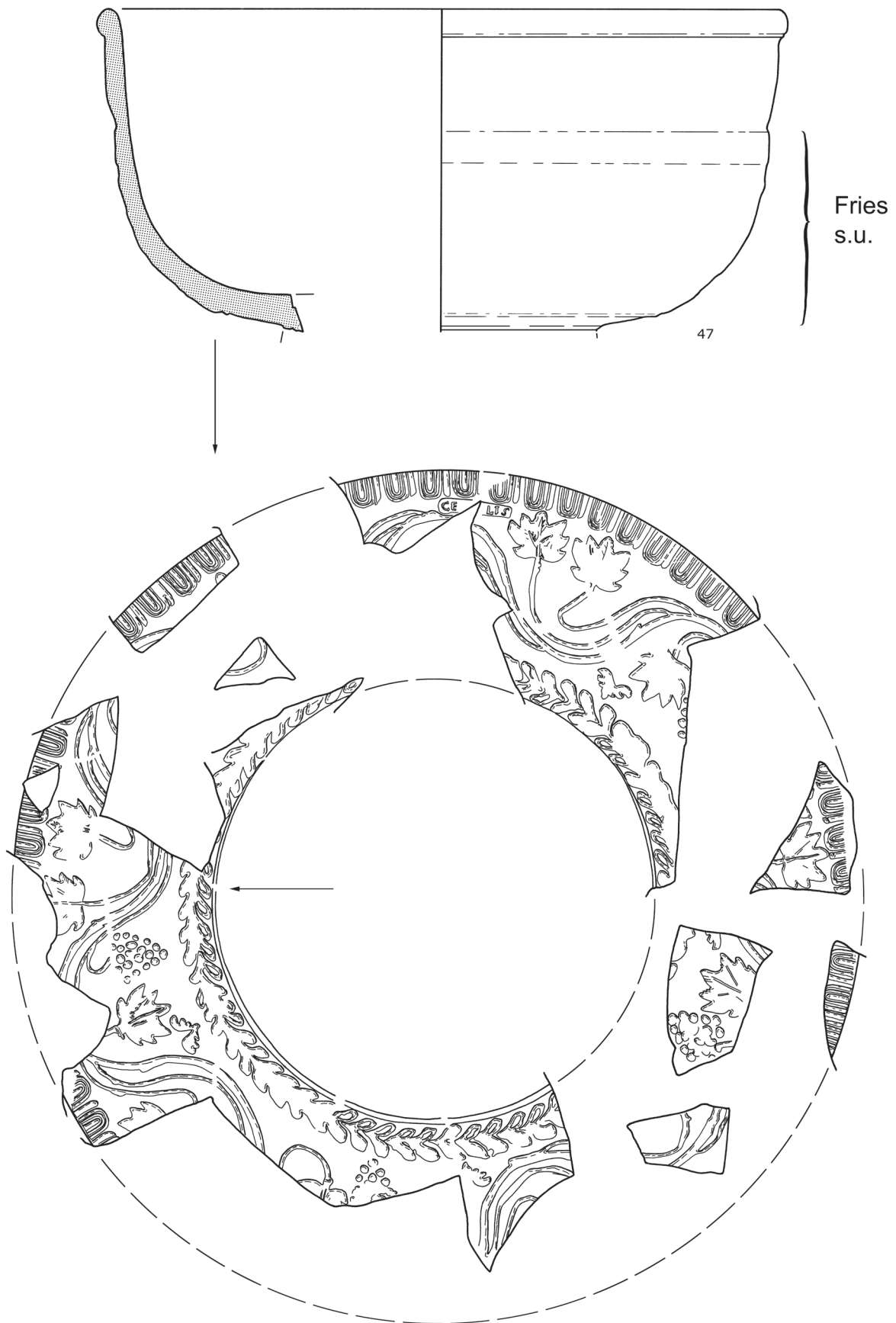

Grab 150

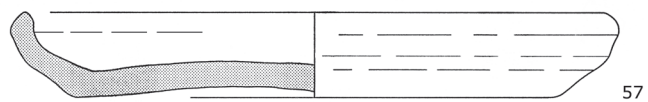
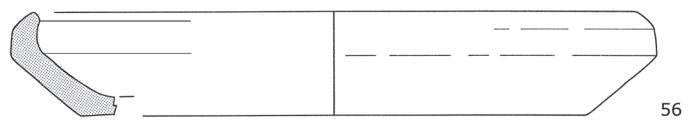
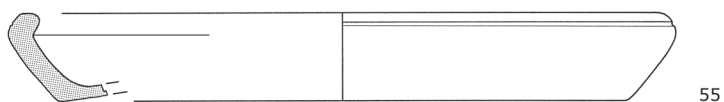
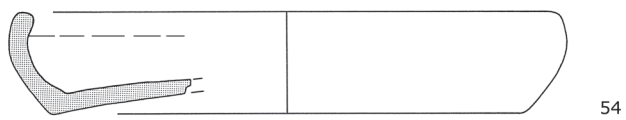
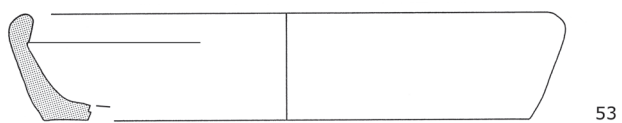
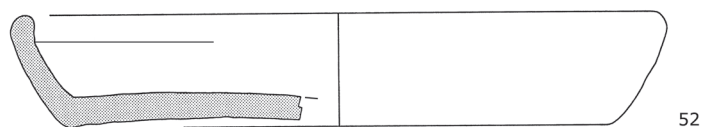
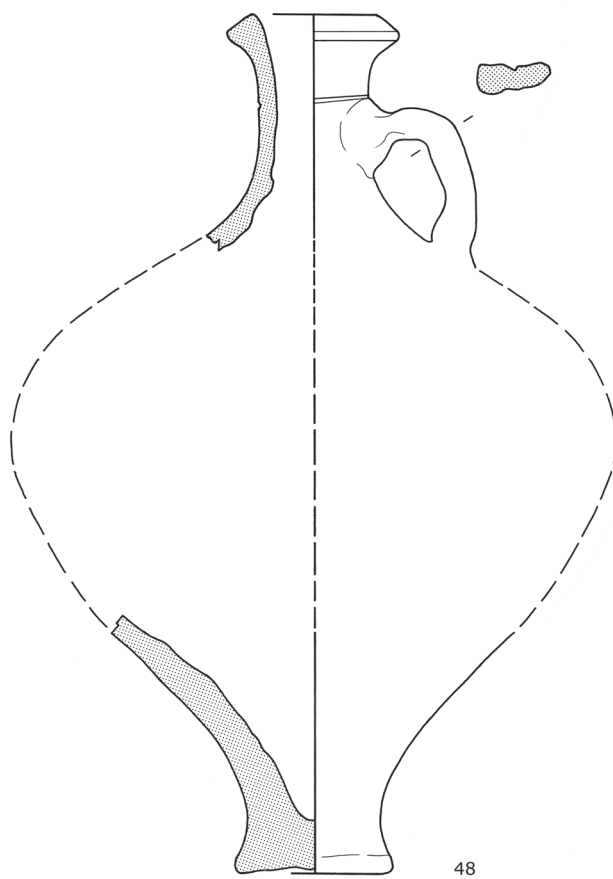
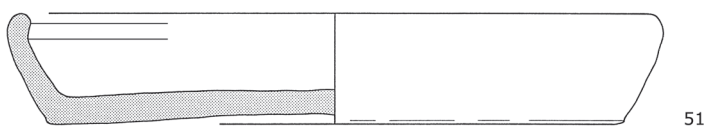
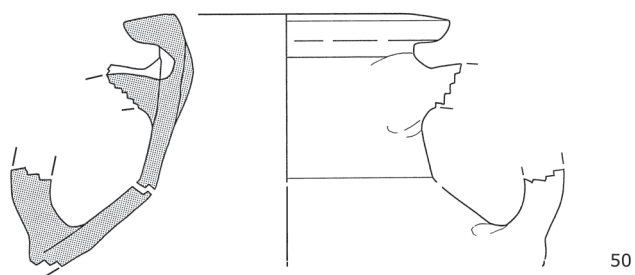
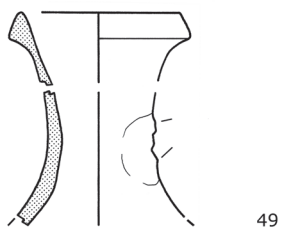

Grab 150

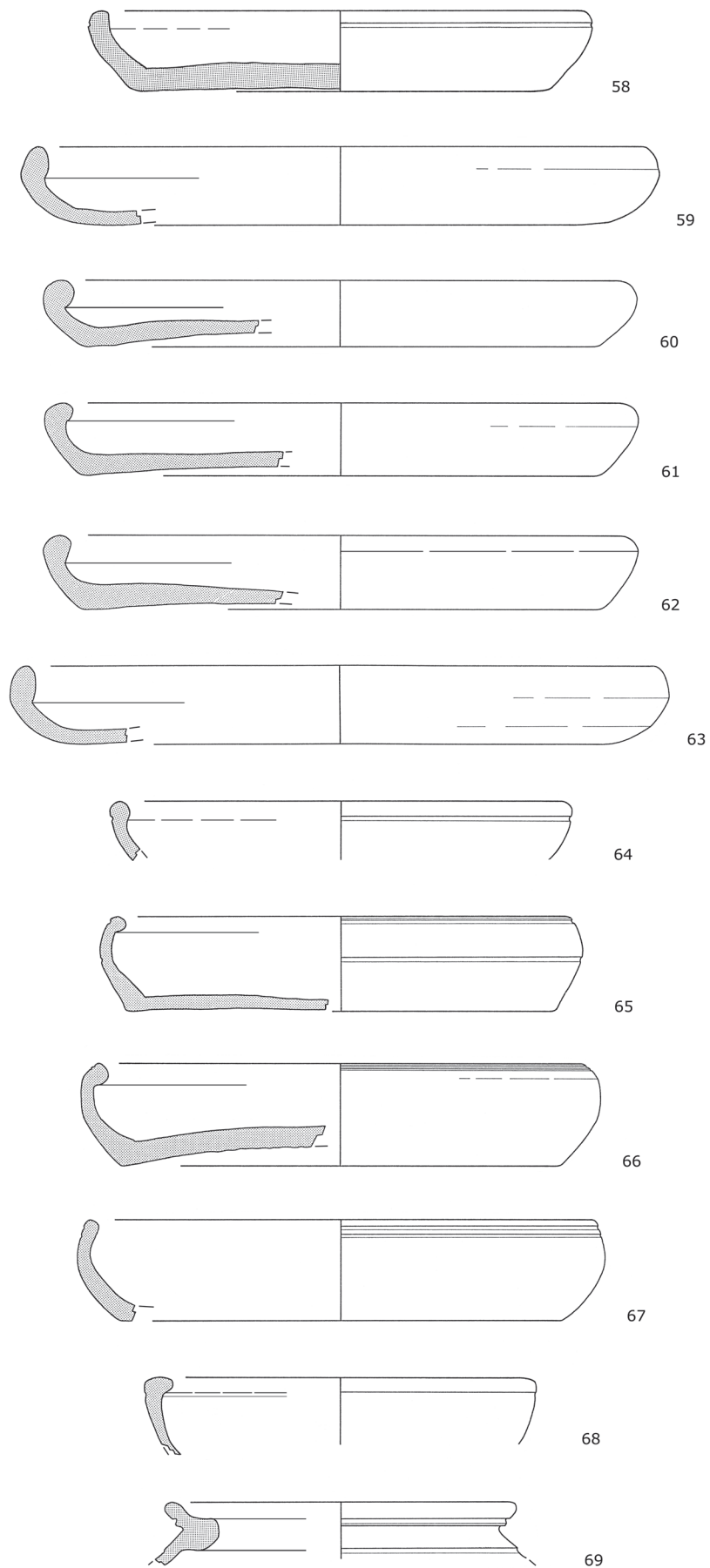

Grab 151



Nagel

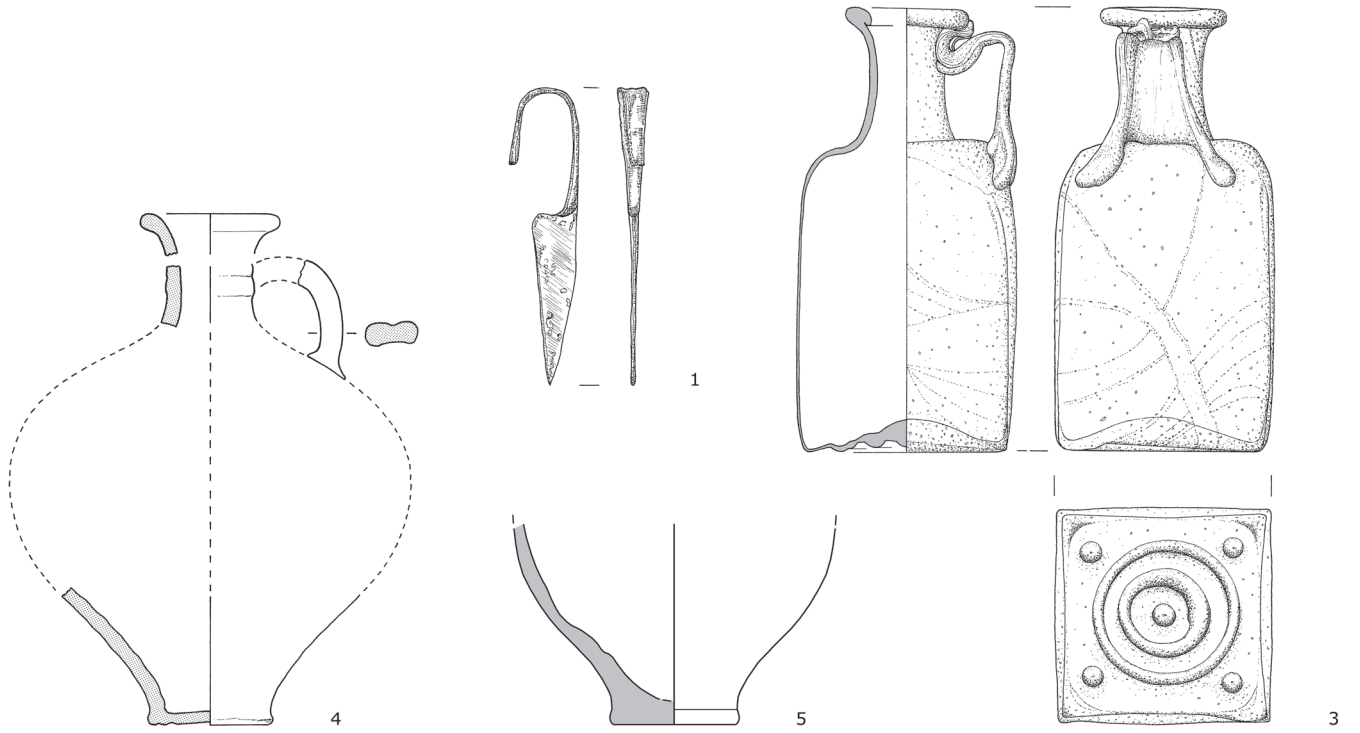

Grab 152



Nägel

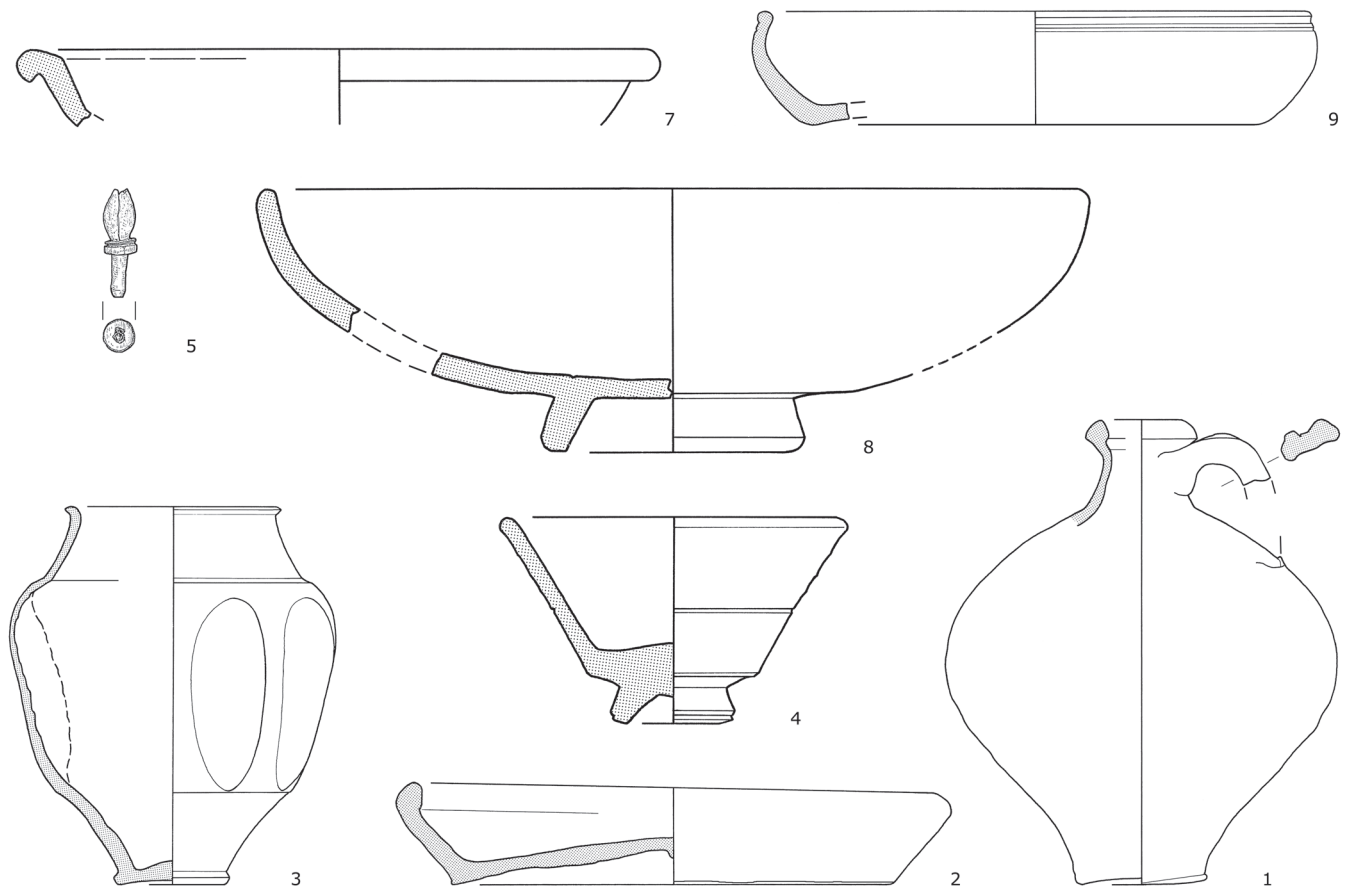

Grab 153



Eisenbeschlag



1 c



1 b

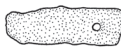

1 a

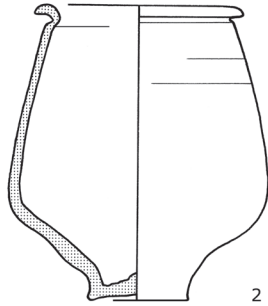

2

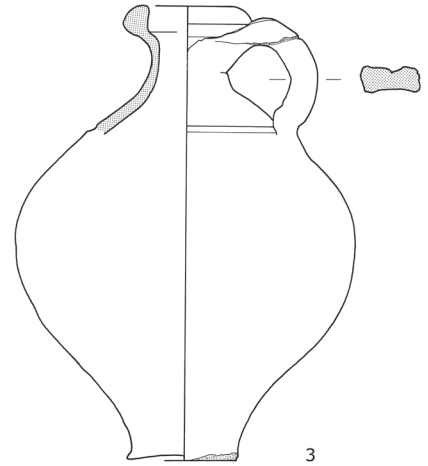

3

Grab 154

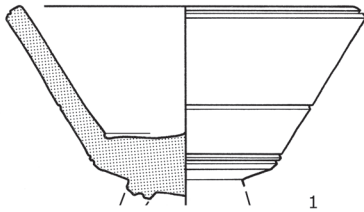

1

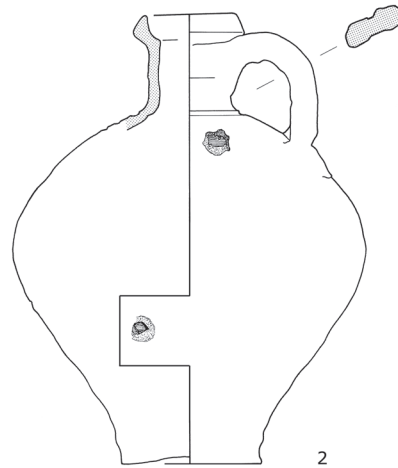

2

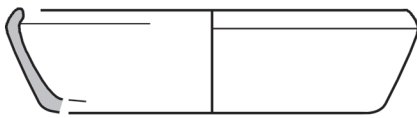

5



3

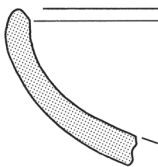

4

Grab 155



Nagel
Ziegel

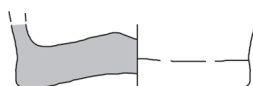

3

Grab 156



Nägel

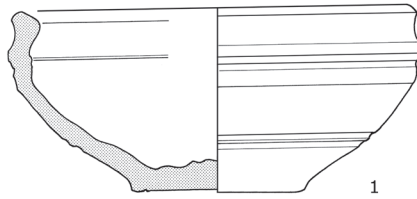

1

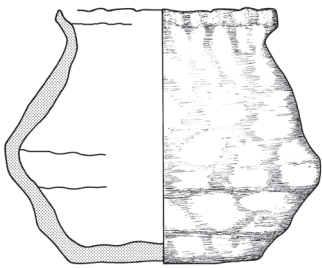

2

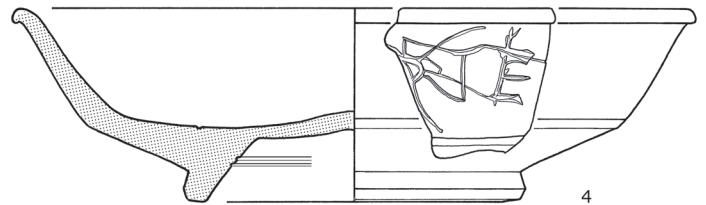
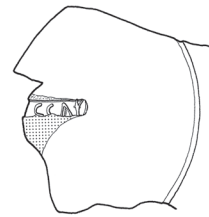

4

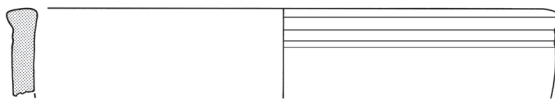

6

Grab 157

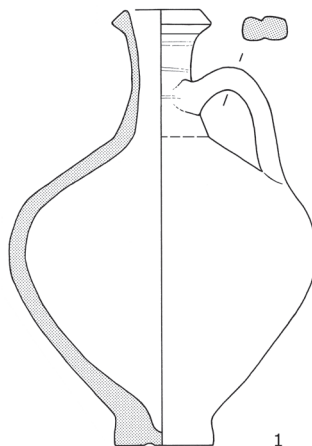

1

Grab 158

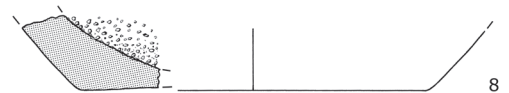
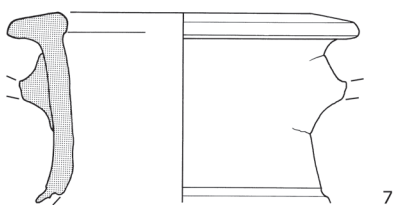
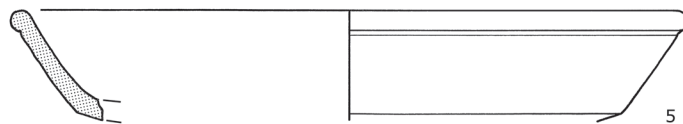
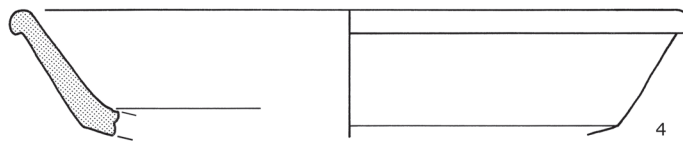
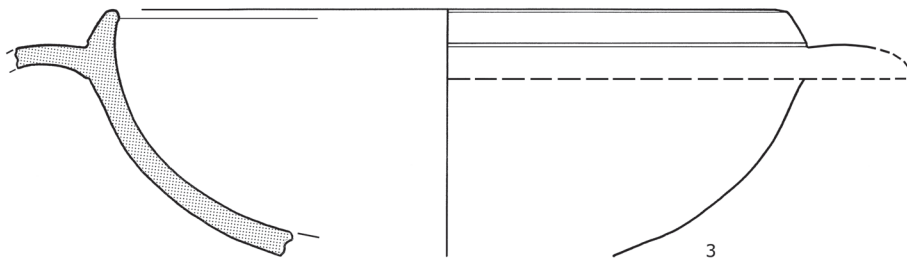
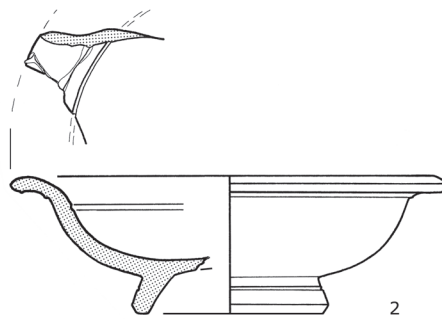
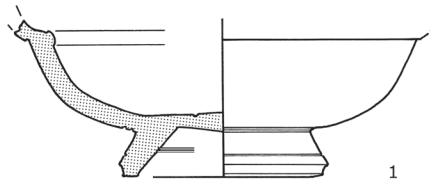

Grab 159



Keramik

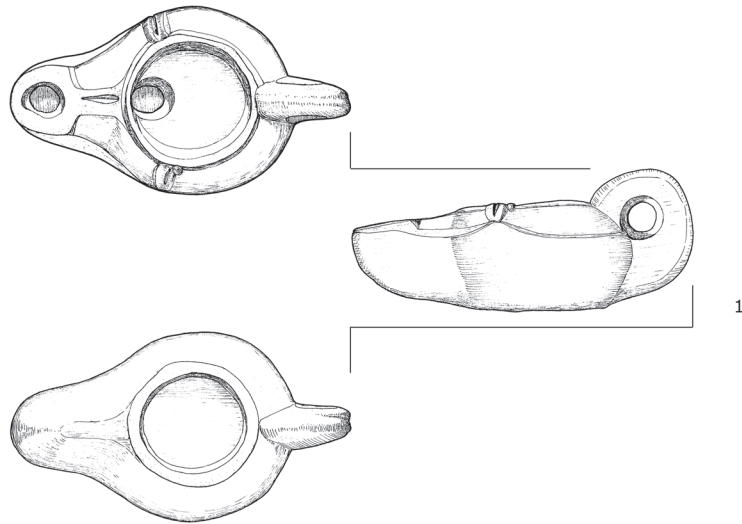

Grab 160



Ziegel

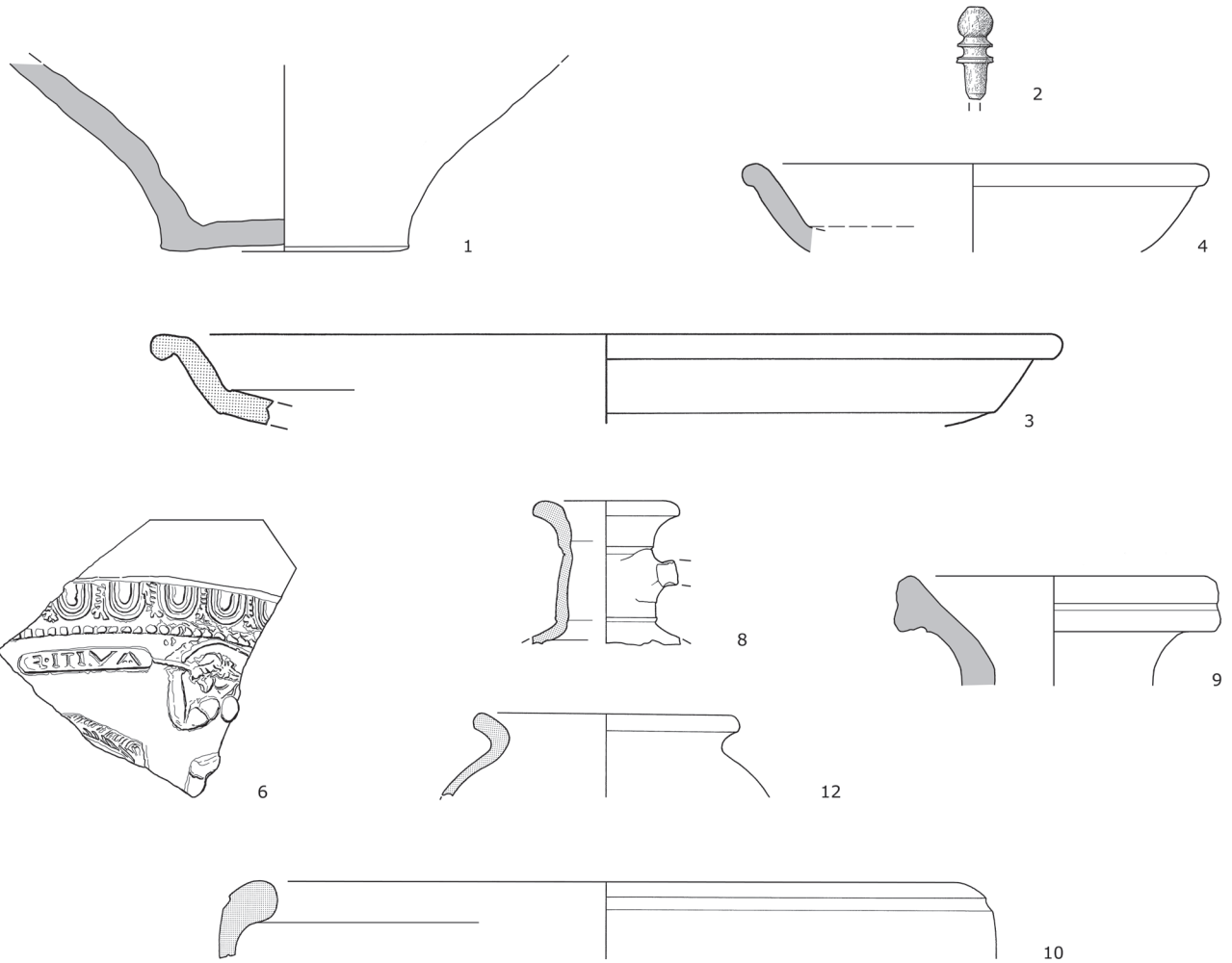

Grab 161

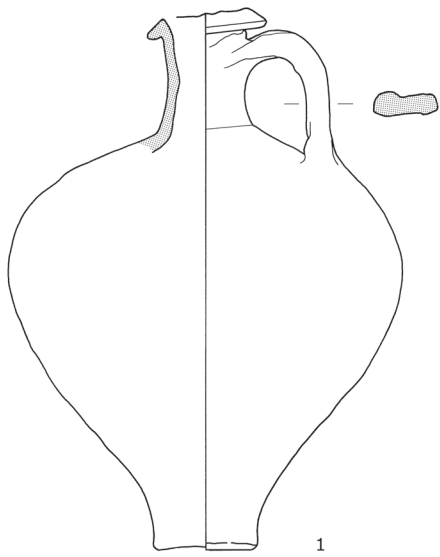

3



4

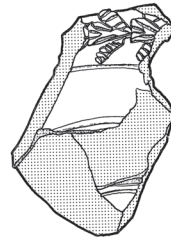

5

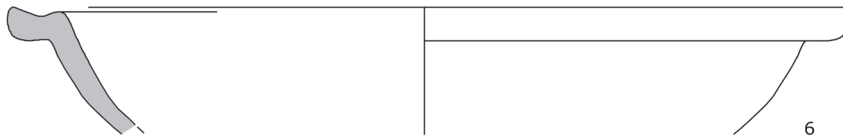

6

Grab 162



2 Nägel

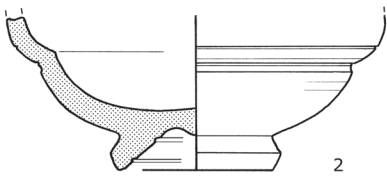

2

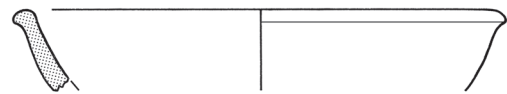

3

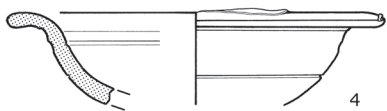
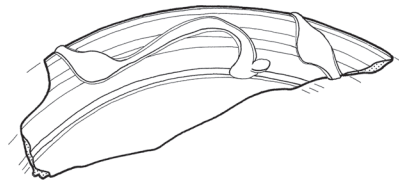
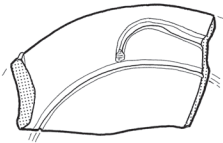

4

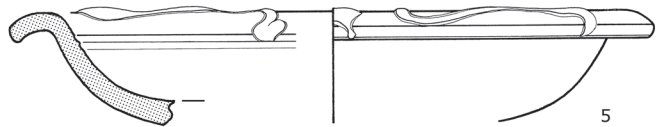

5

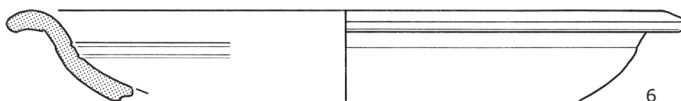

6

← Grab 162

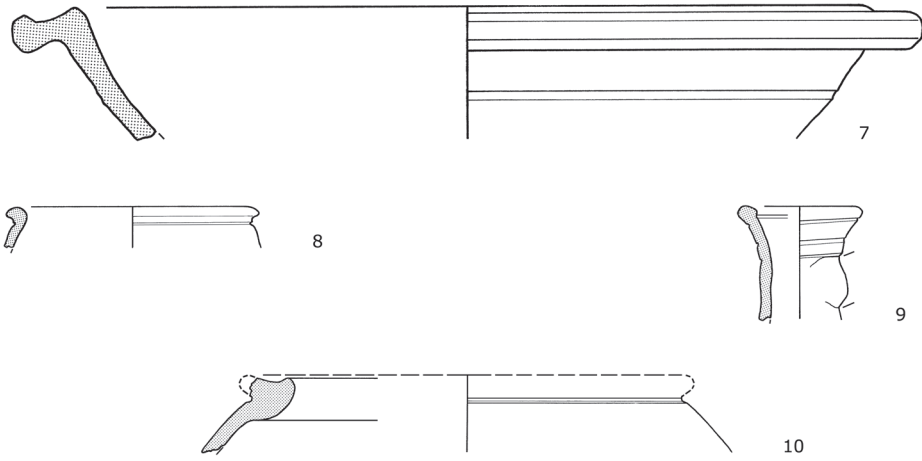

Fundstelle 163

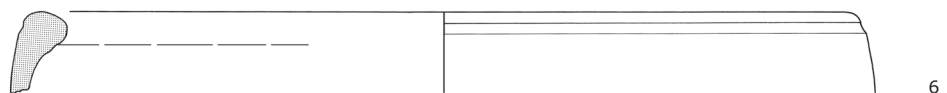
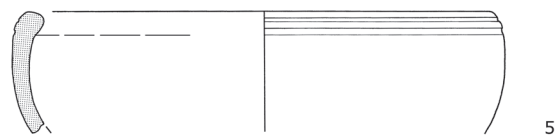
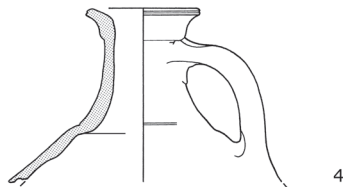
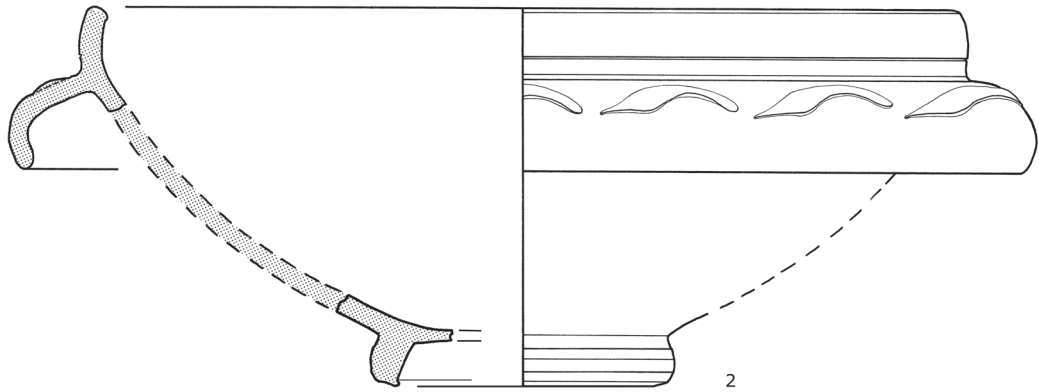
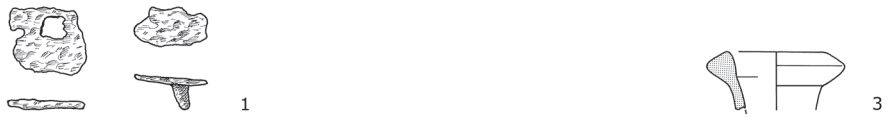

Grab 164



Keramik



Grab 165

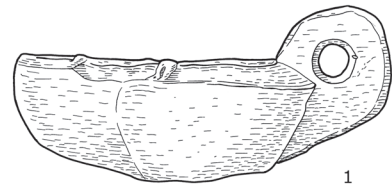
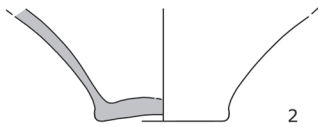
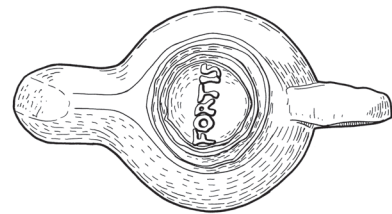
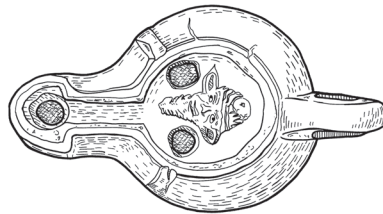

Grab 166

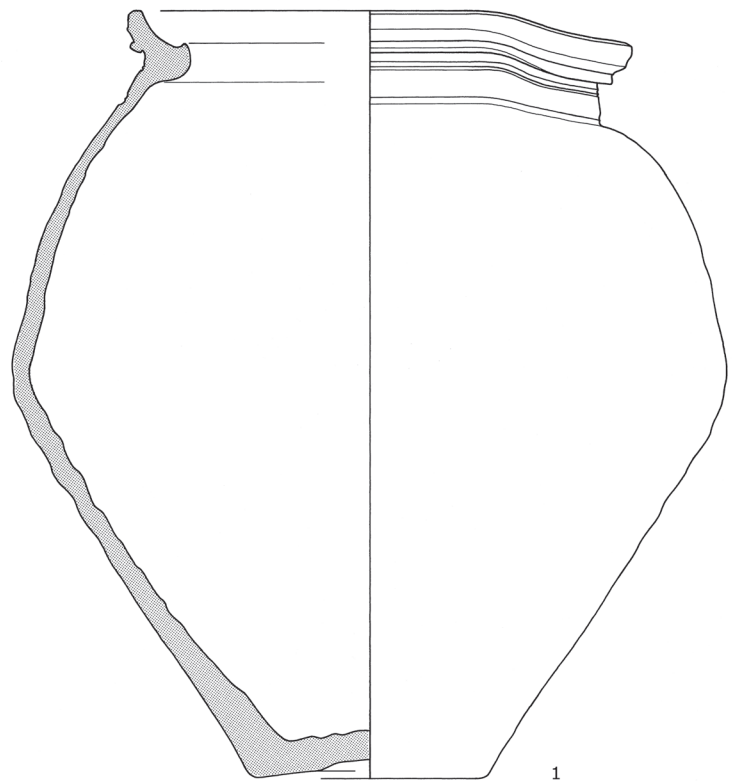
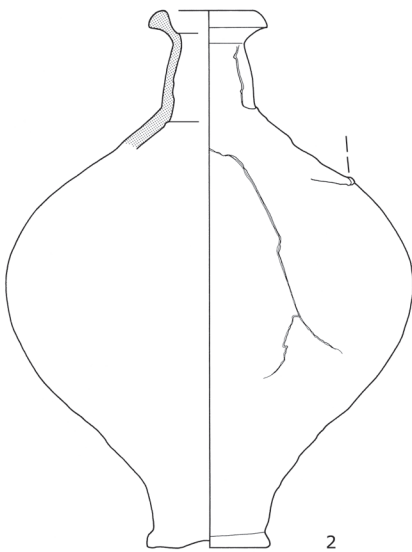

Grab 167



Glas
Schuhnägel

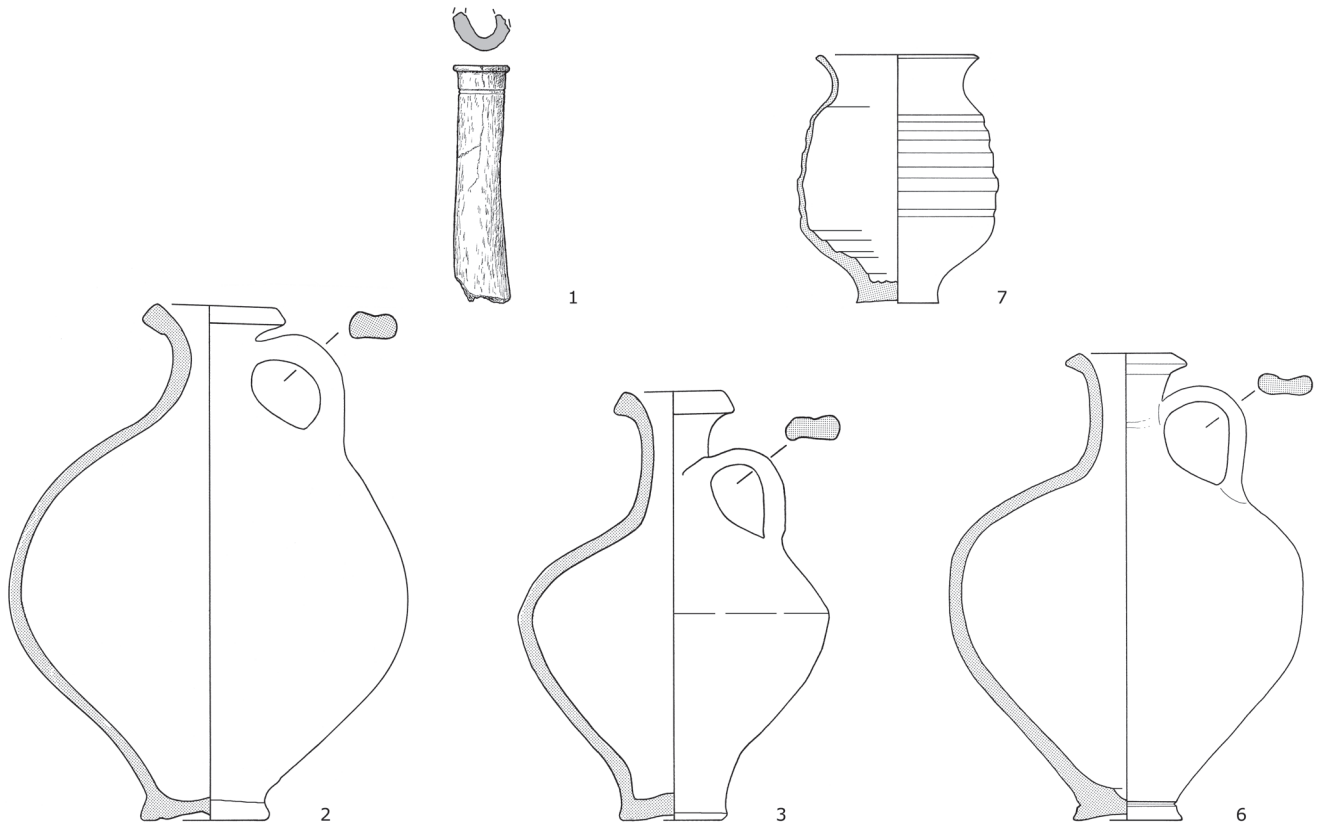

Grab 168

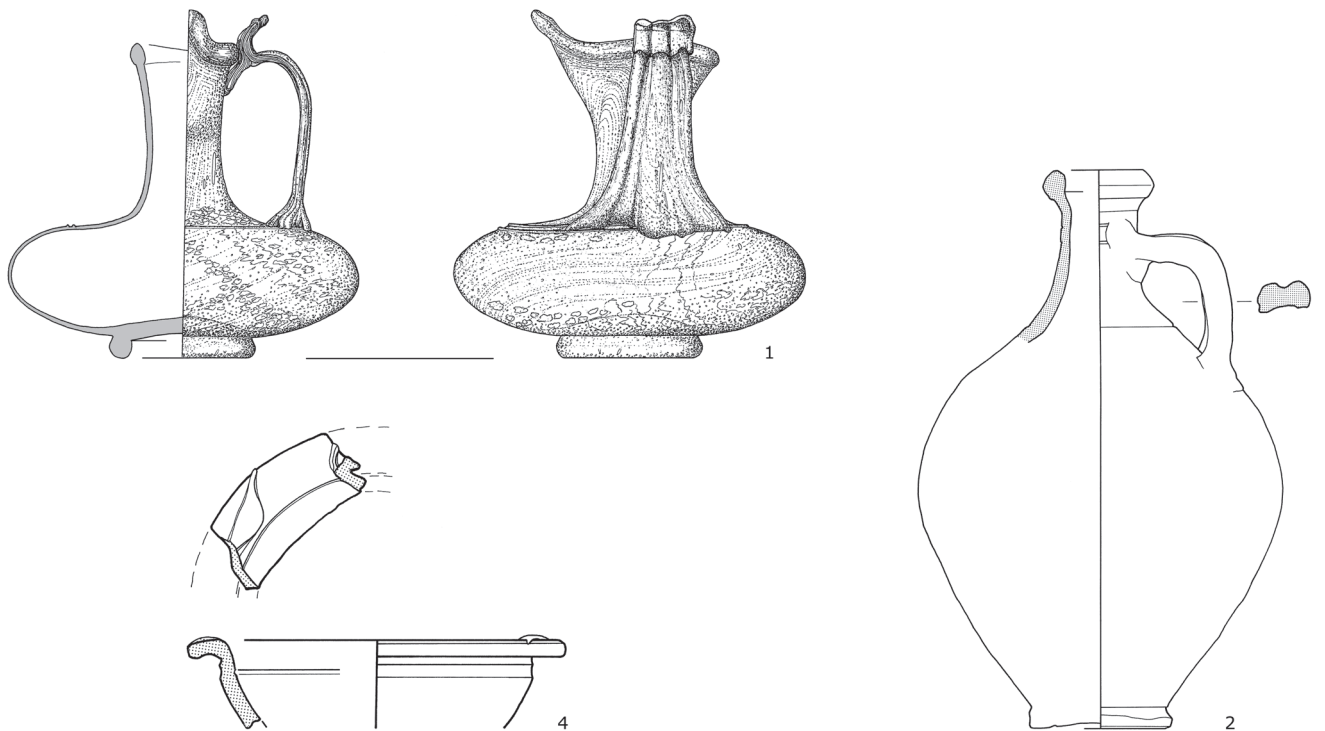

← Grab 168



Grab 169

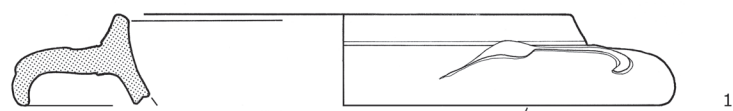
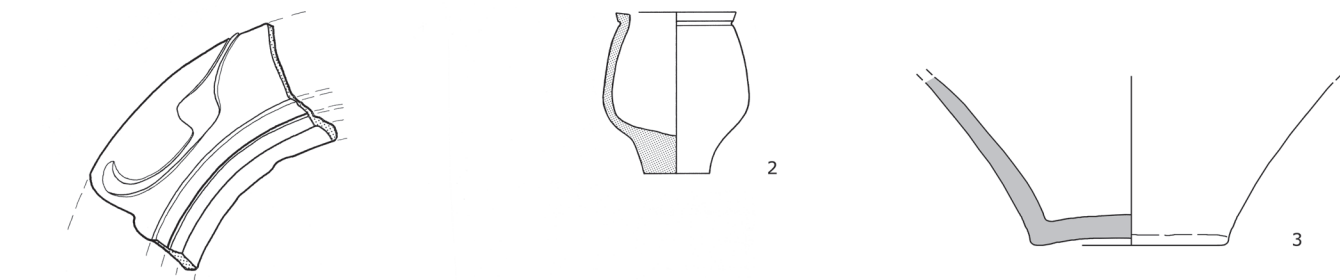

Grab 170



Glas
Nagel
Ziegel

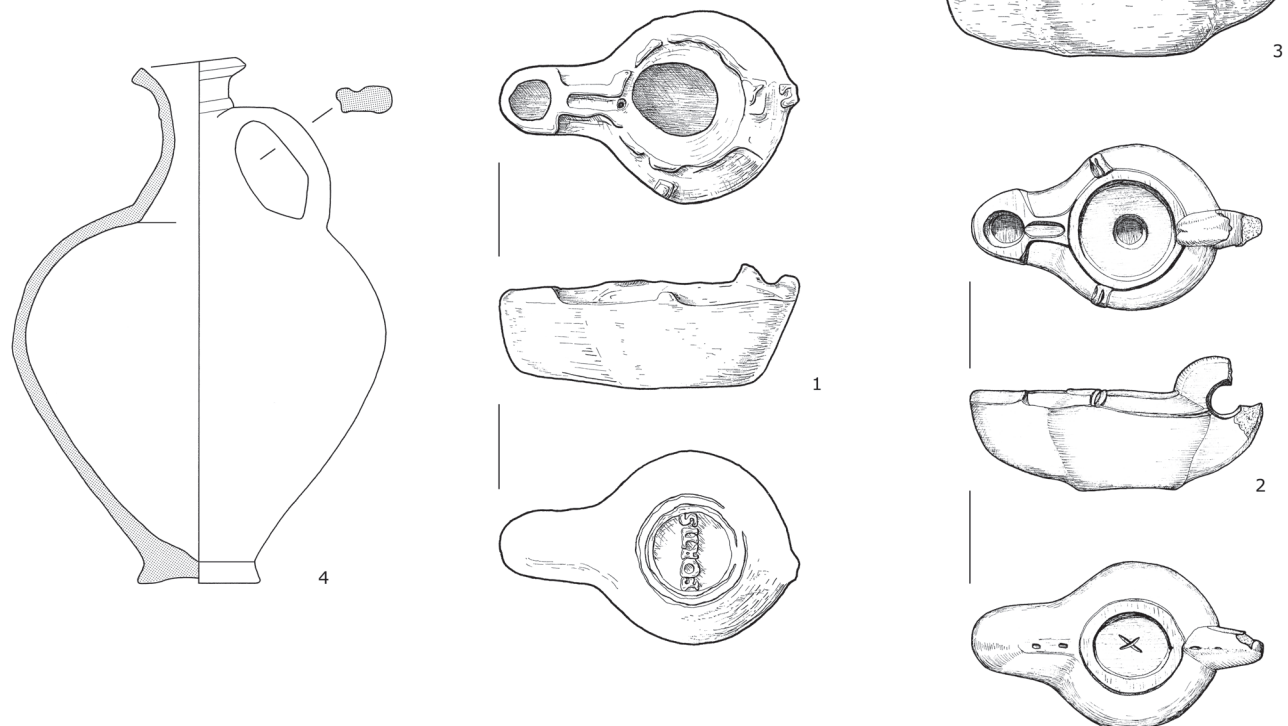

Grab 171



Bein



Grab 172

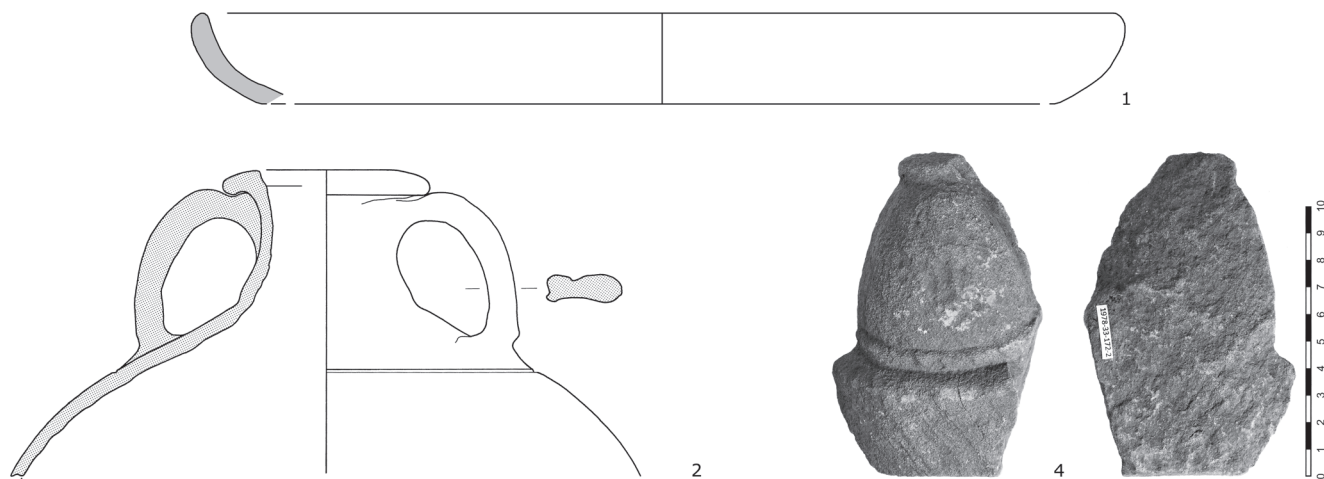

Grab 173

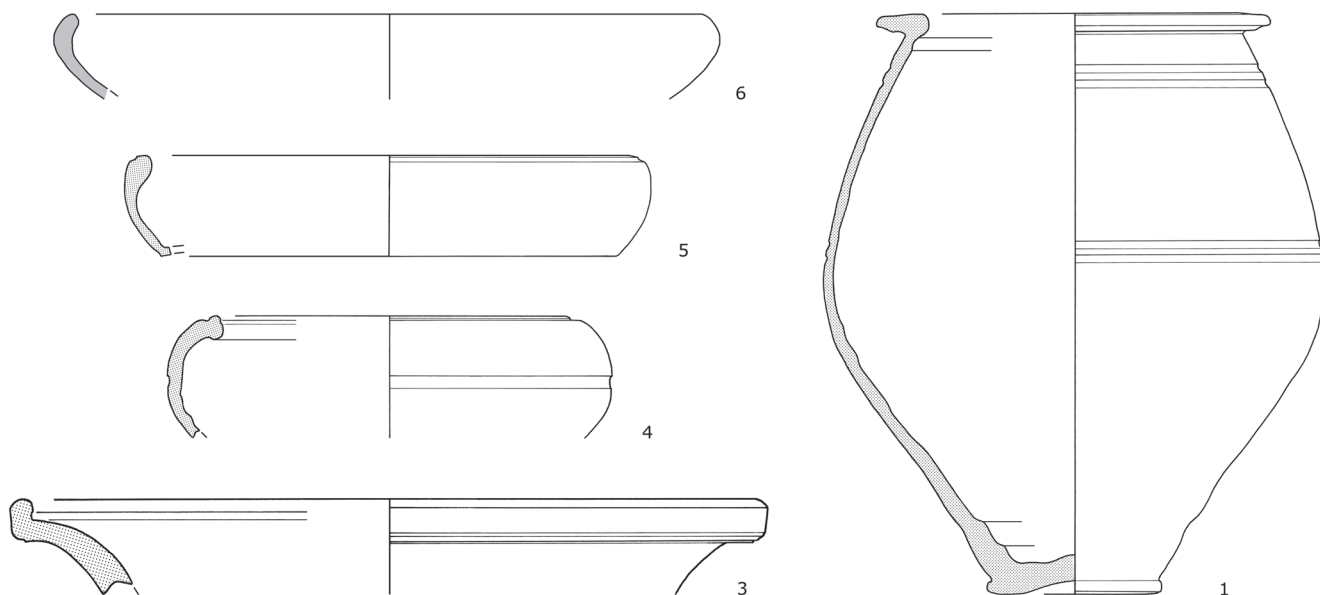
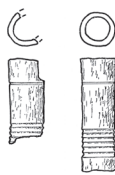

Grab 174



Nagel

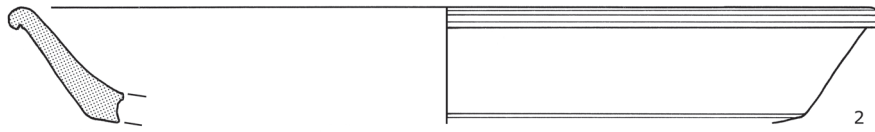

Grab 175

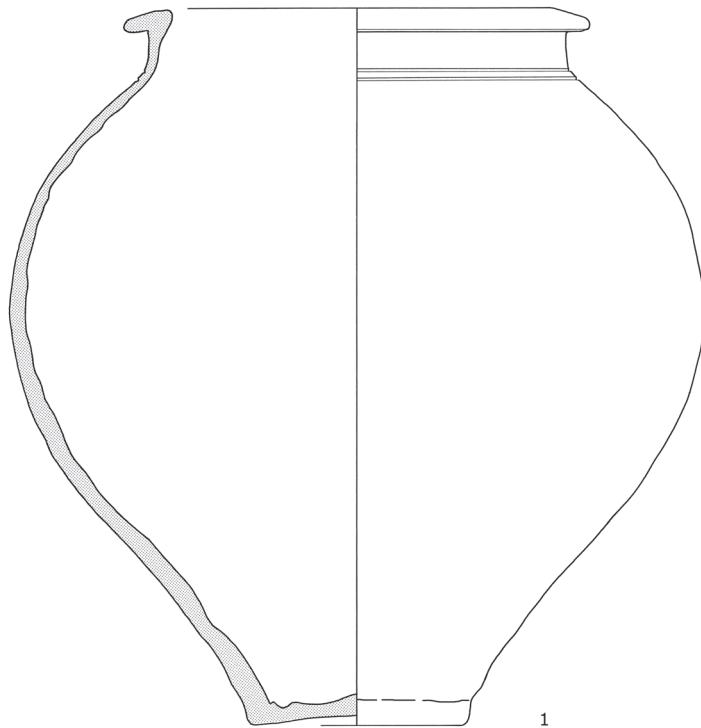
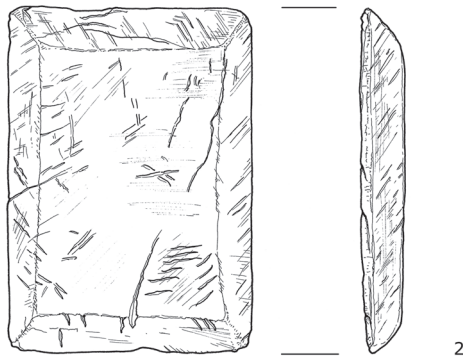

Fundstelle 176

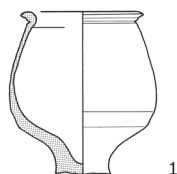

Grab 177



Nagel

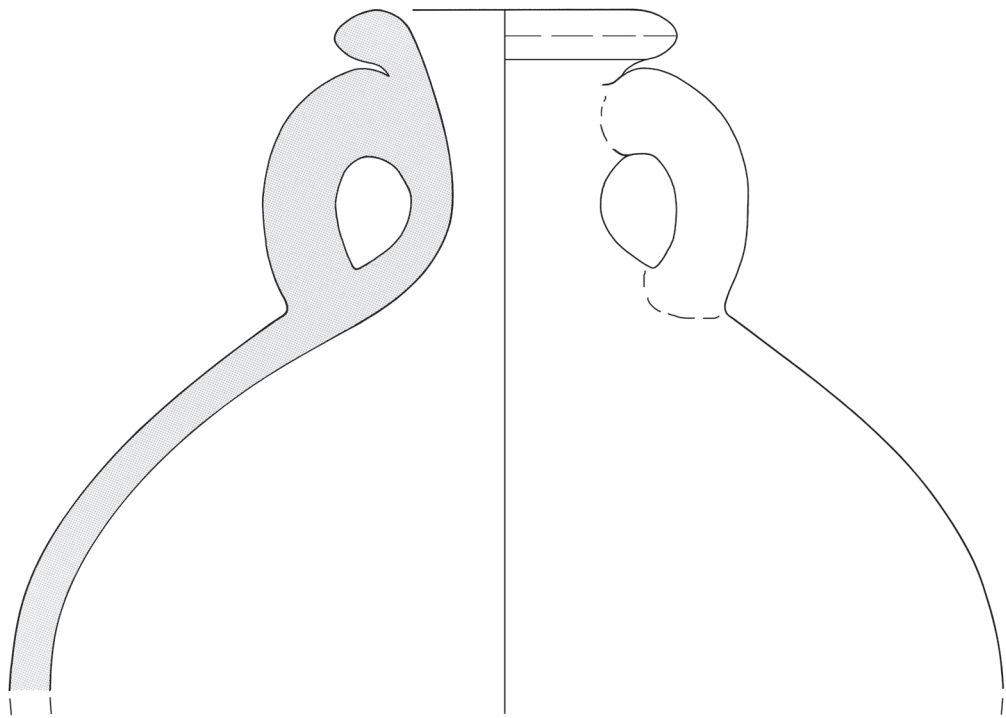
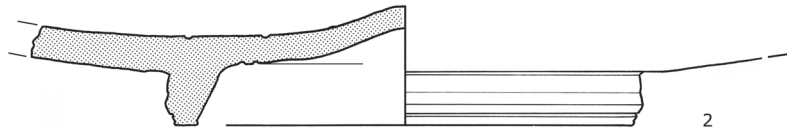

Grab 178

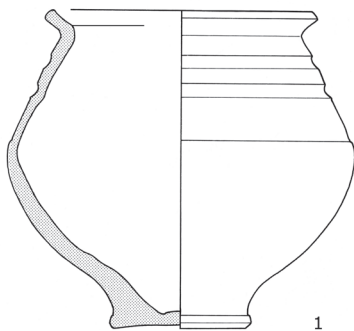

Grab 179



Keramik

Grab 180



Nagel

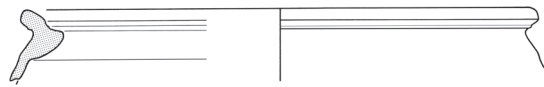
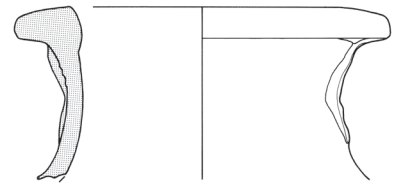
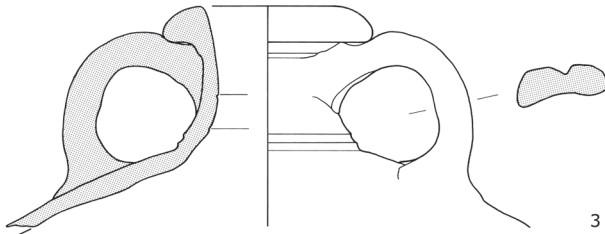

Grab 181



Eisen

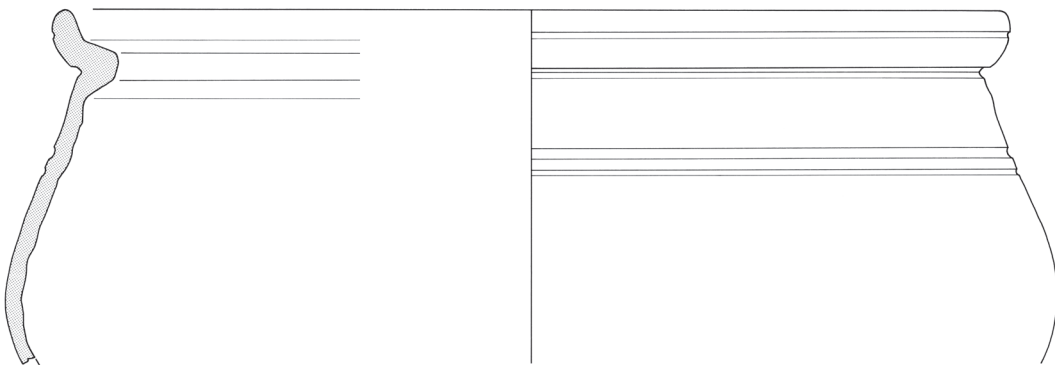
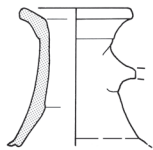
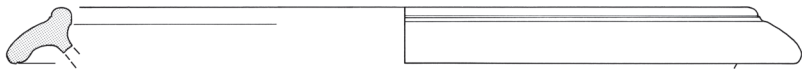

Grab 182



Ziegel

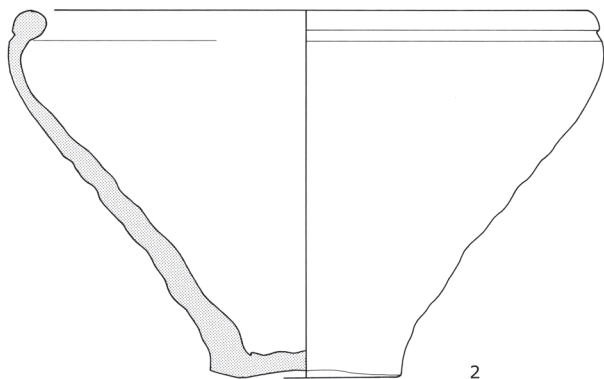

Fundstelle 183



Glas
Keramik



Grab 184

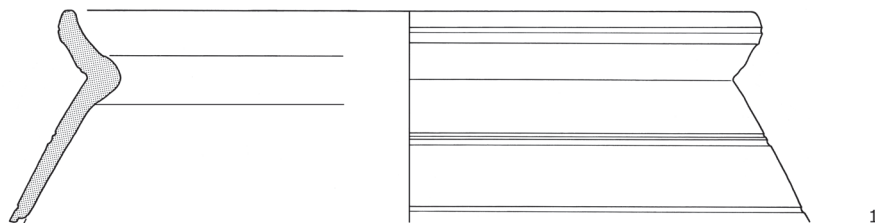
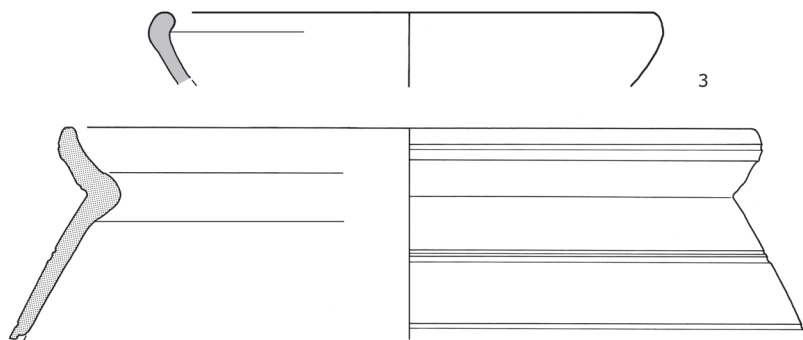

Grab 185

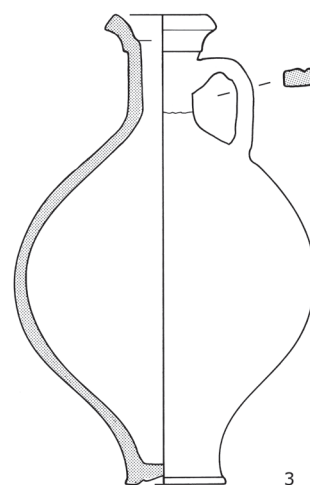
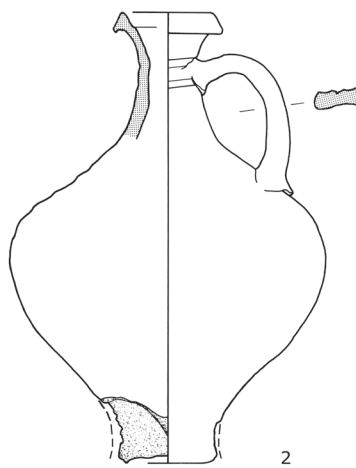
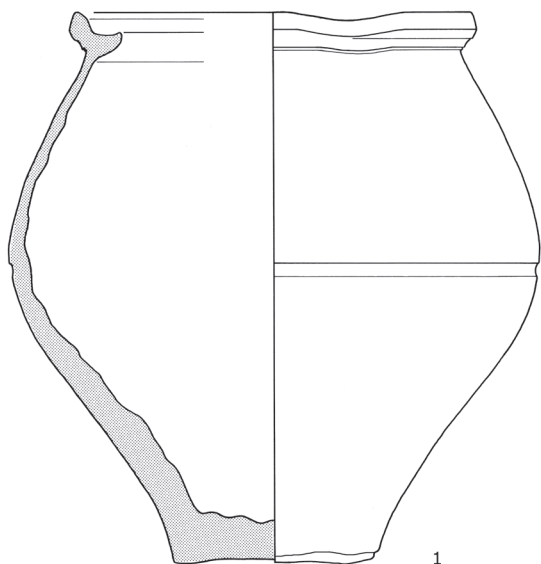

Grab 186

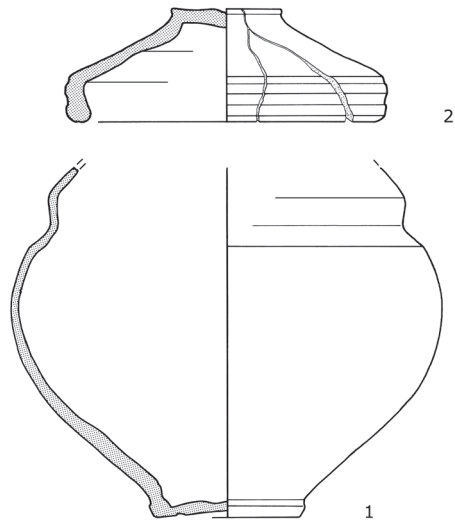

Grab 187



Nägel
Nadel

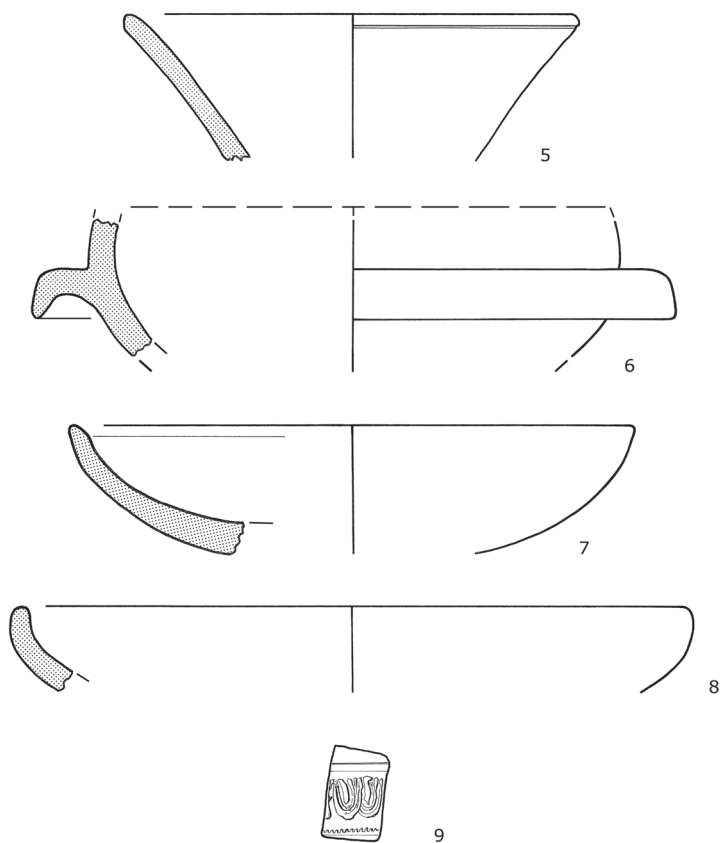
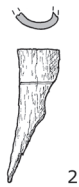
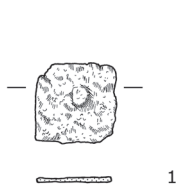

Grab 187

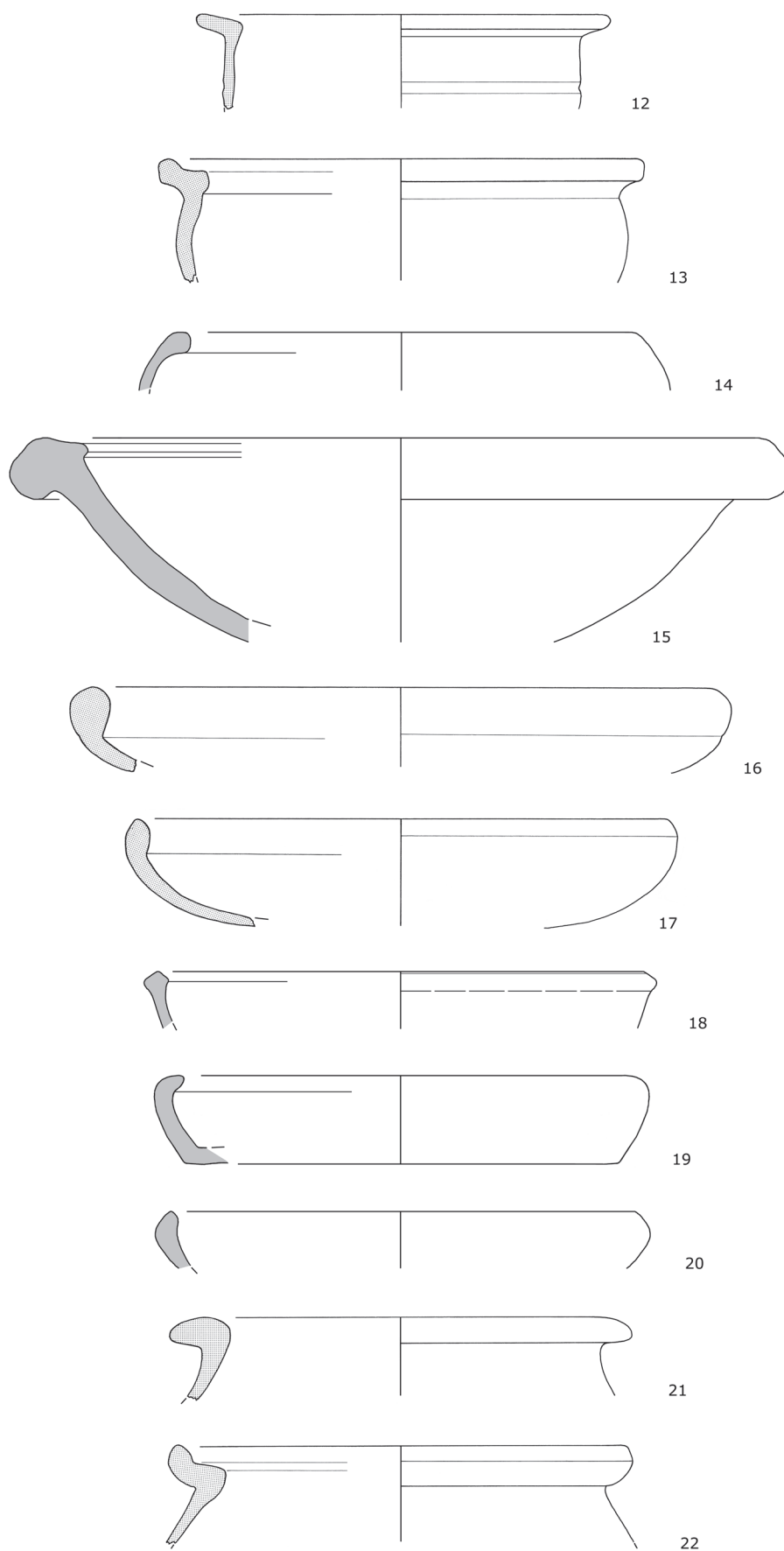

Grab 188

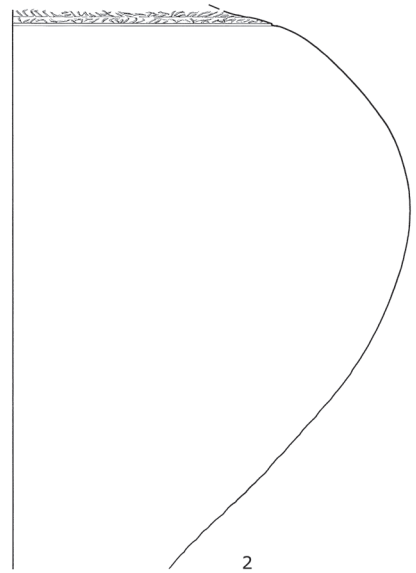
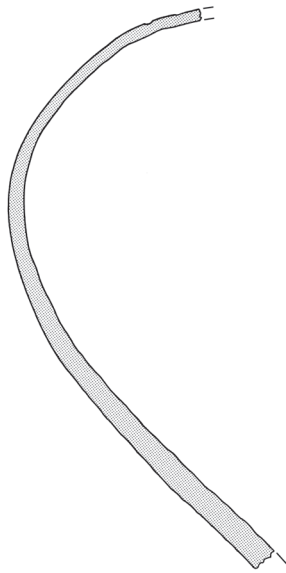
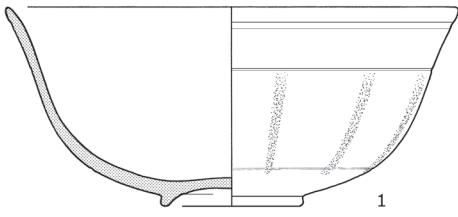

Grab 189



Schuh-
nägel

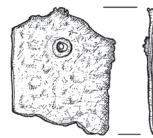
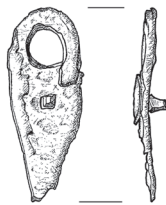

3

2

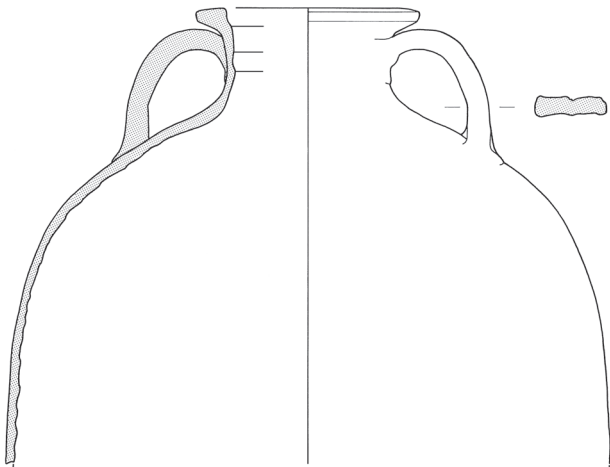

1

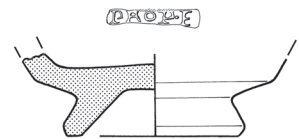

5

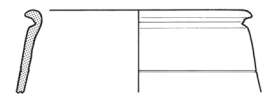

9

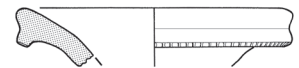

10



11

Grab 189

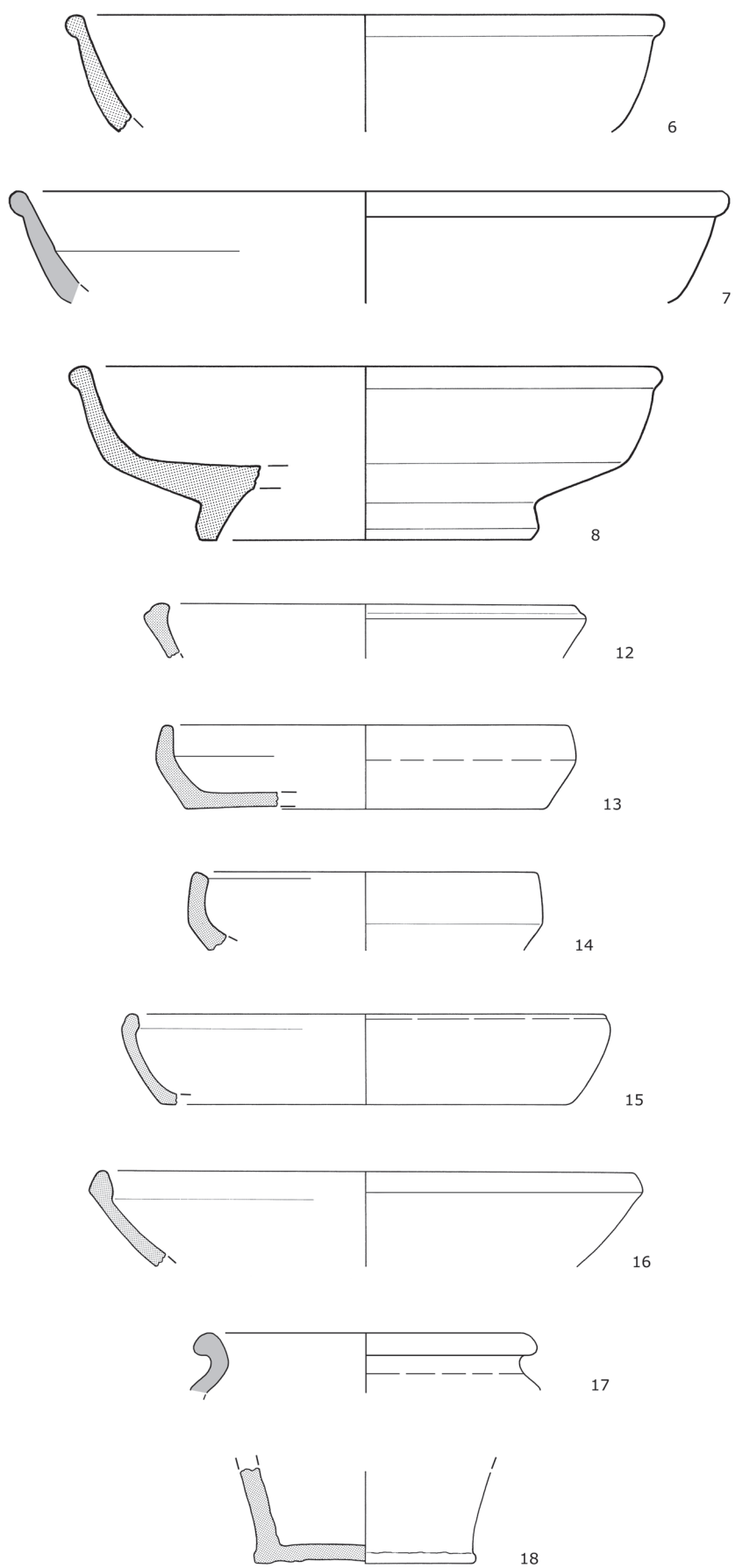

Grab 190



Schuh-
nägel
Nagel

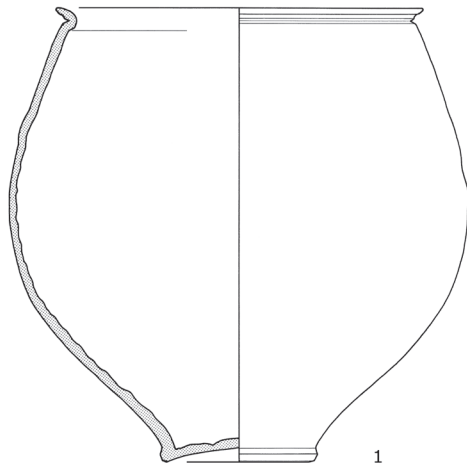

1

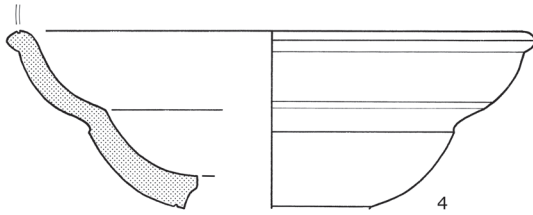

4

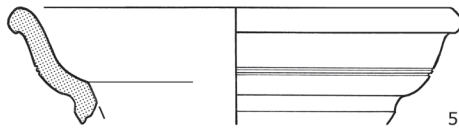

5

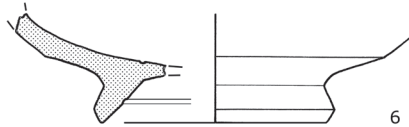

6

Fundstelle 191

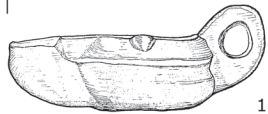
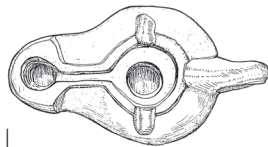

1

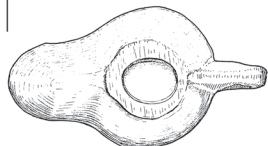

Grab 192



Schuhnagel
Nägel

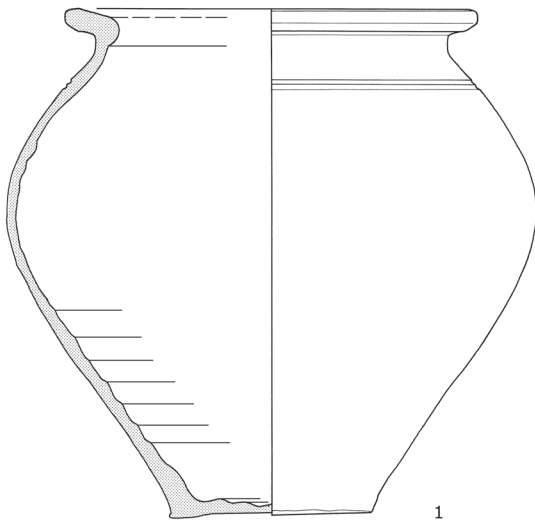

1

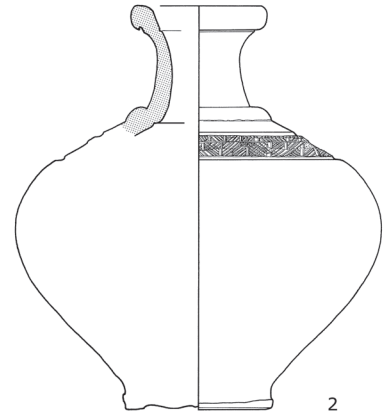

2

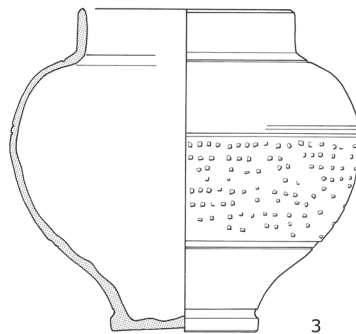

3

Grab 193



Nagel

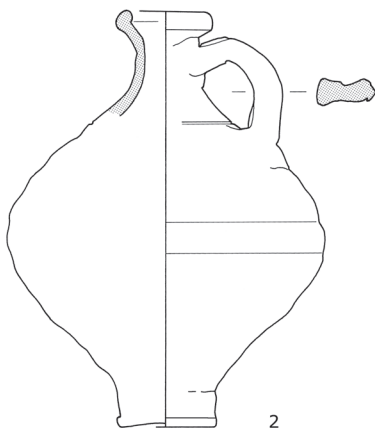

2

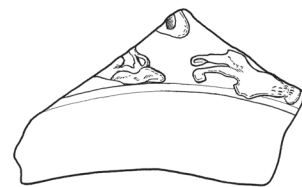

4

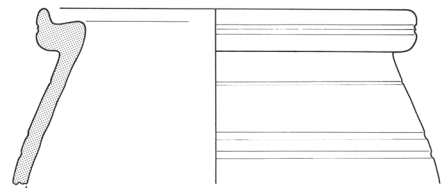

5

Grab 194



Keramik



Grab 195



Glas
Nägel
Bein

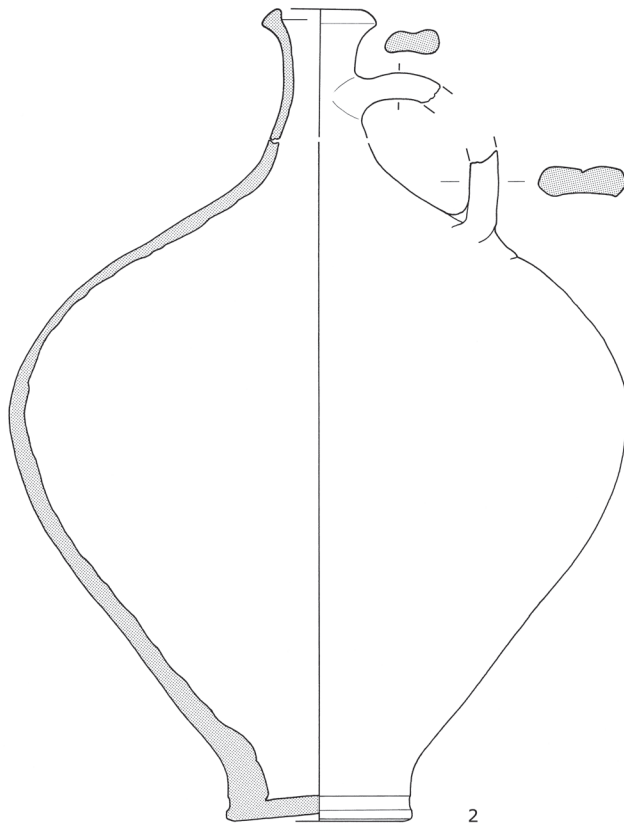
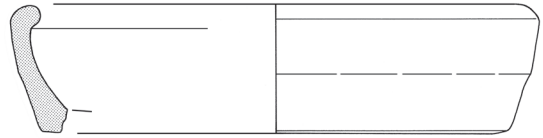
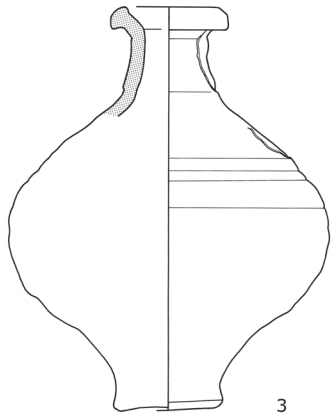

Fundstelle 196

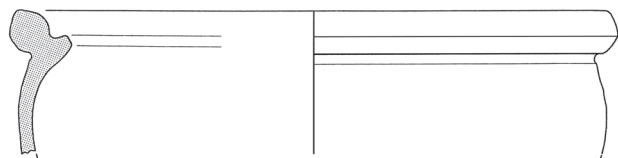

Grab 197

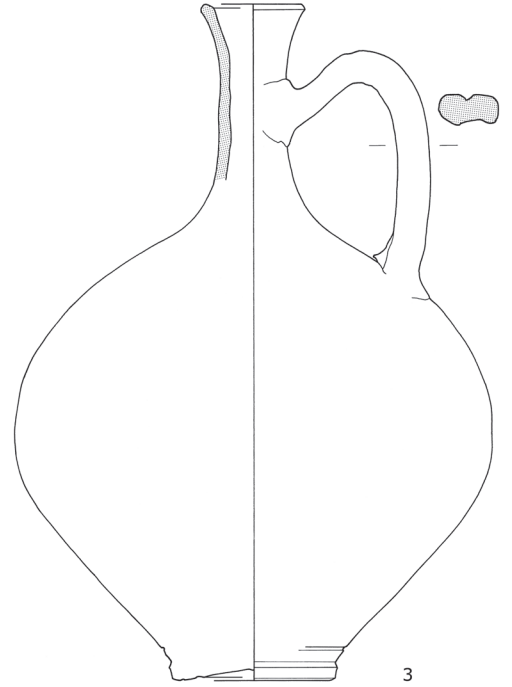
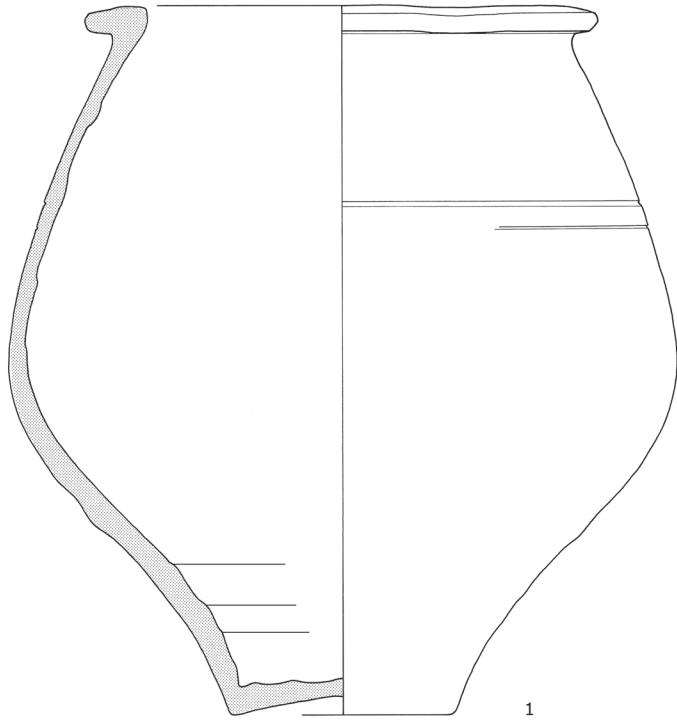

Grab 198



Schuhnagel
Nägel

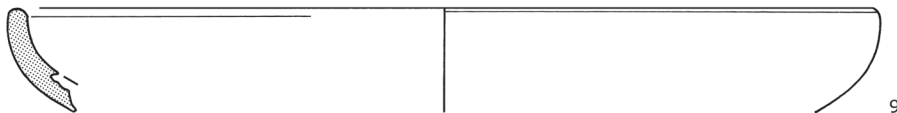
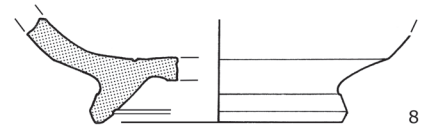
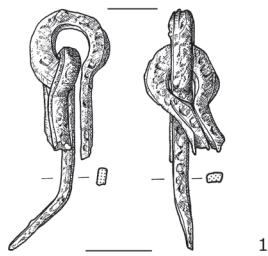
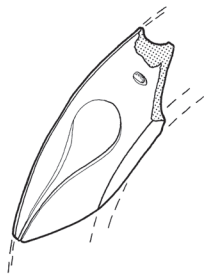

←
Grab 198

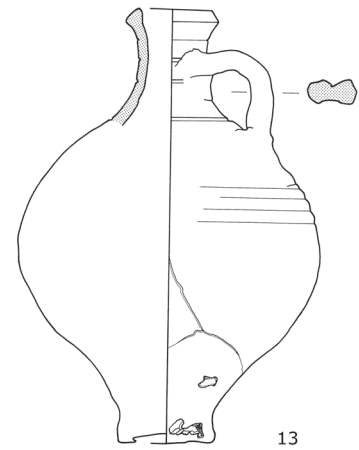
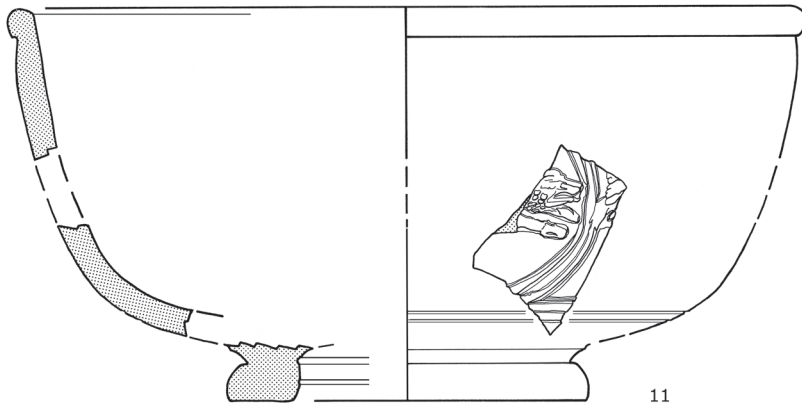
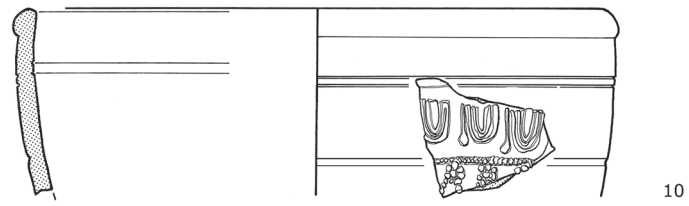

Grab 199



Nägel

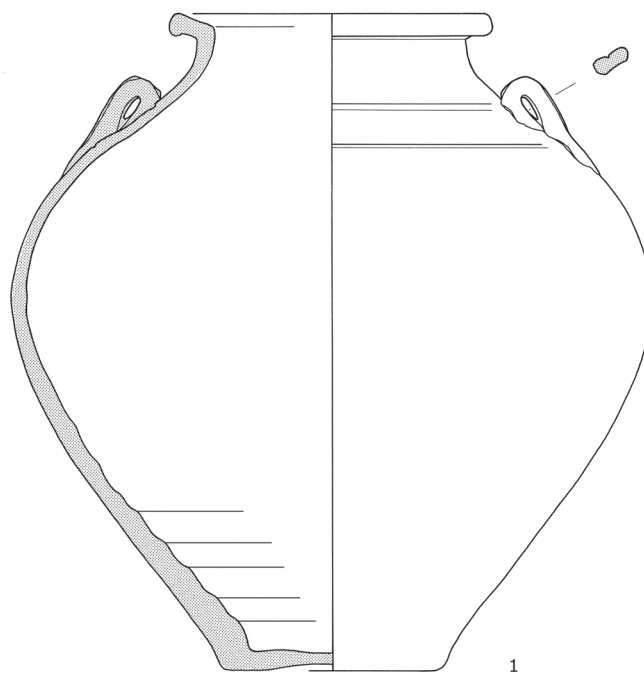

Fundstelle 200

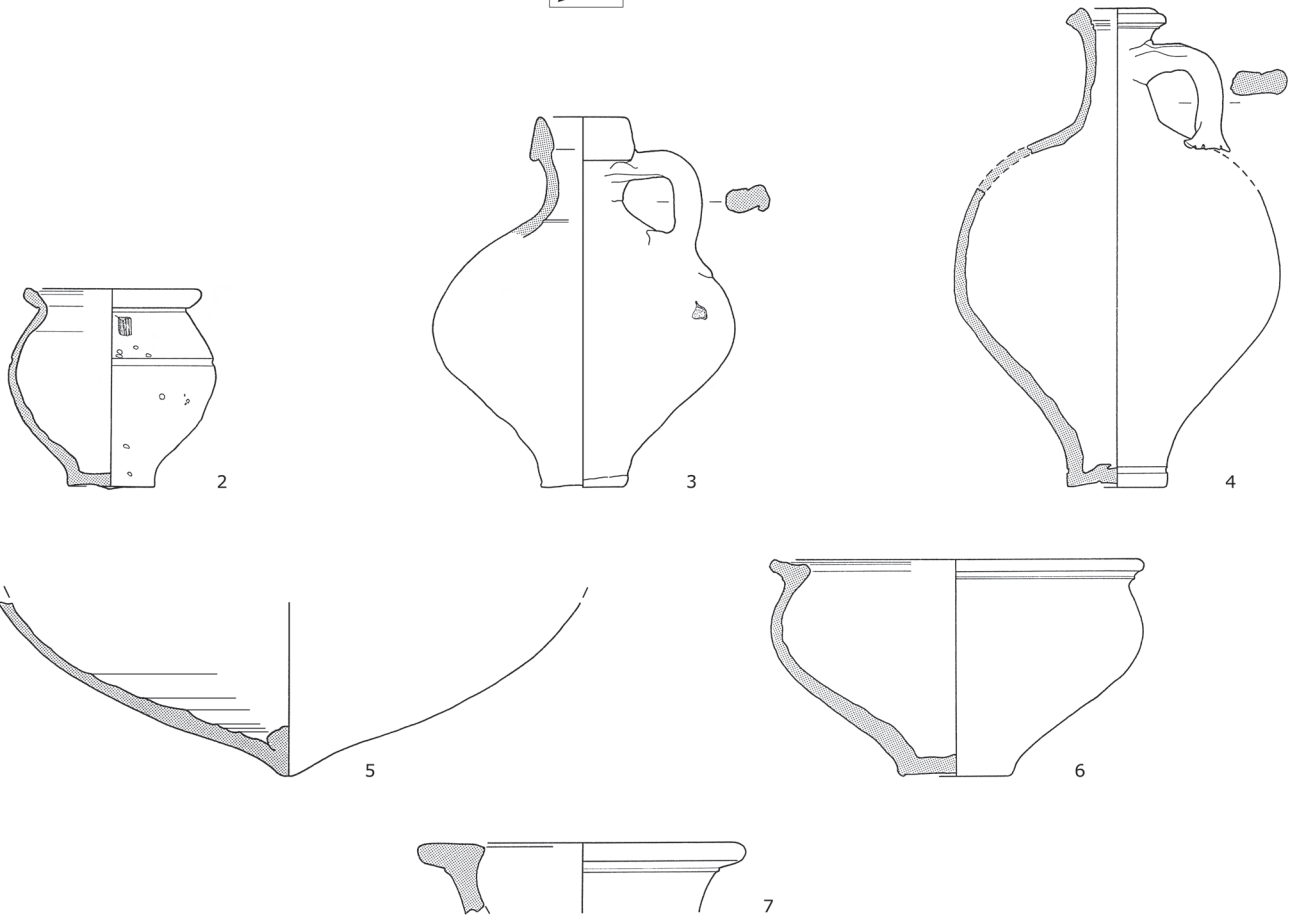

Grab 201

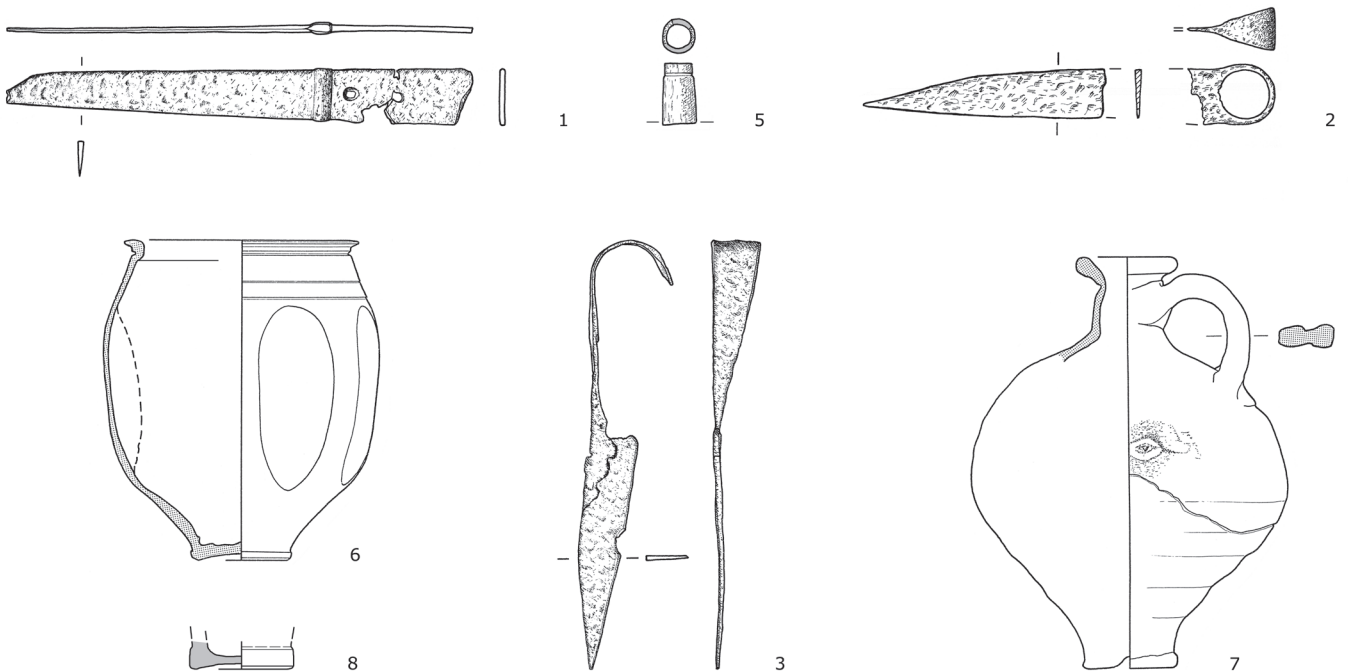

Grab 202



Nagel

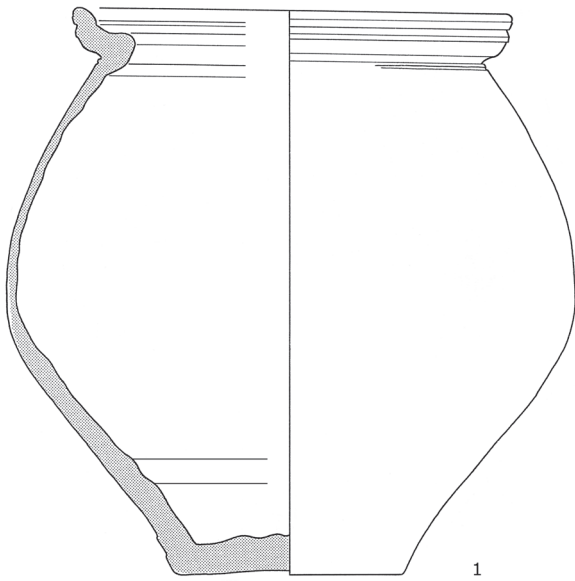

1

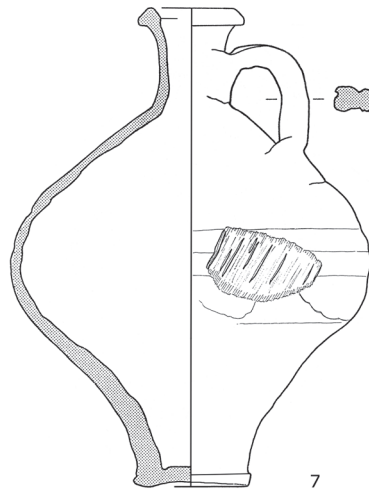

7

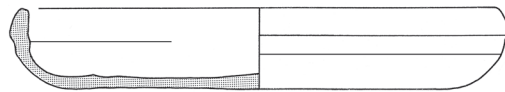

2

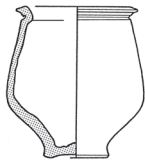

3



5

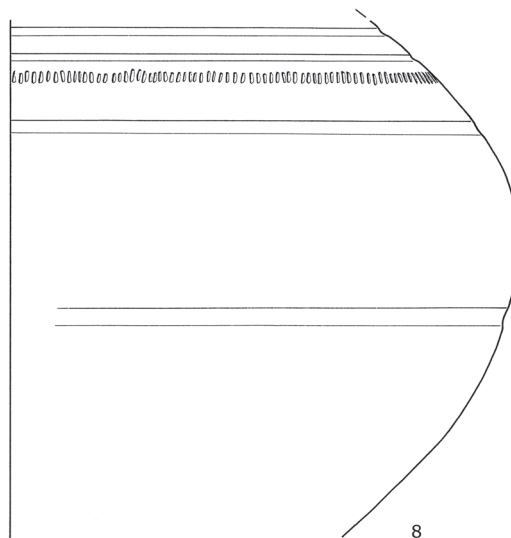
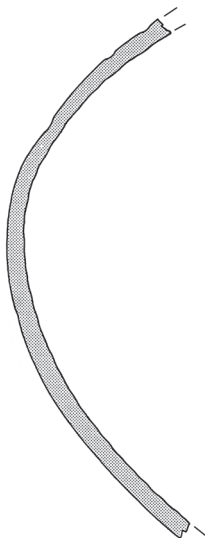

8

Grab 203



Glas
Schuhnagel

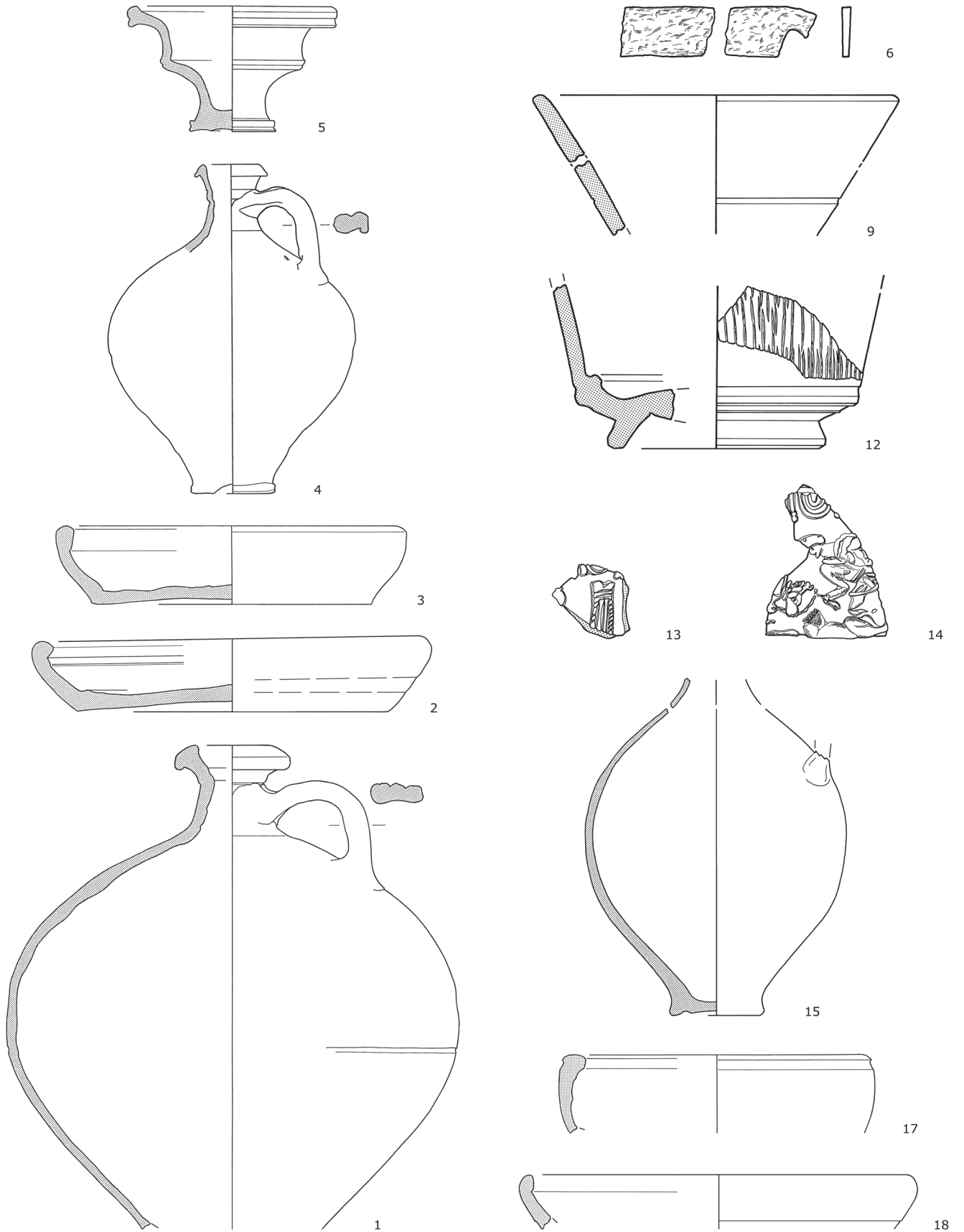

Grab 204



Nägel



Mittelerz
1.H.1.Jh.n.Chr.

1

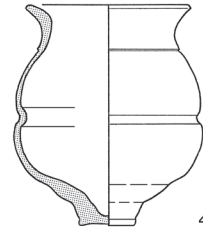
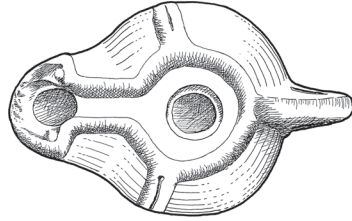

4

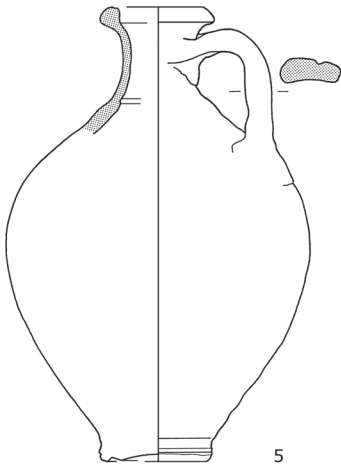

5

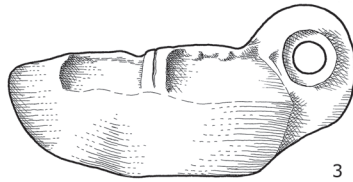

3

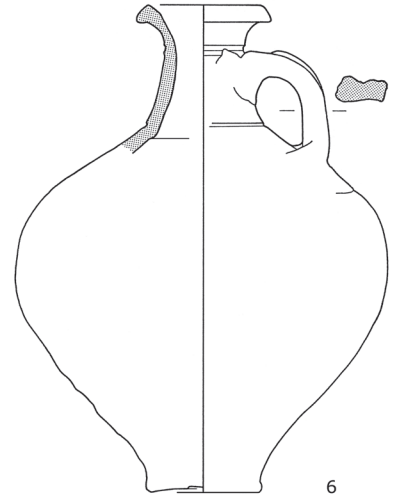

6

Fundstelle 205



Nagel

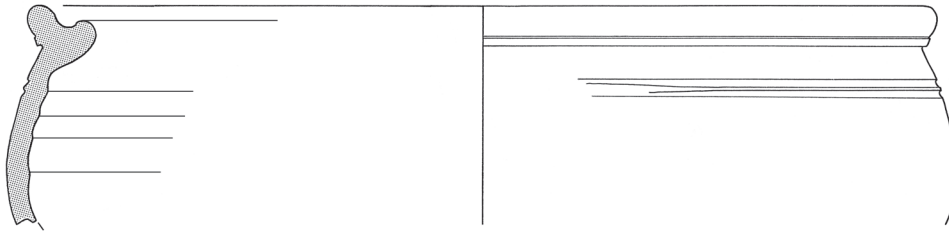

2

Grab 206



Elagabal
218-222 n.Chr.
Denar

2

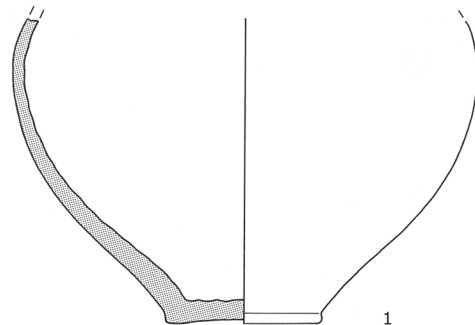

1

Grab 207



Eisenschlacke
Nägel
Keramik

Grab 208



Nägel

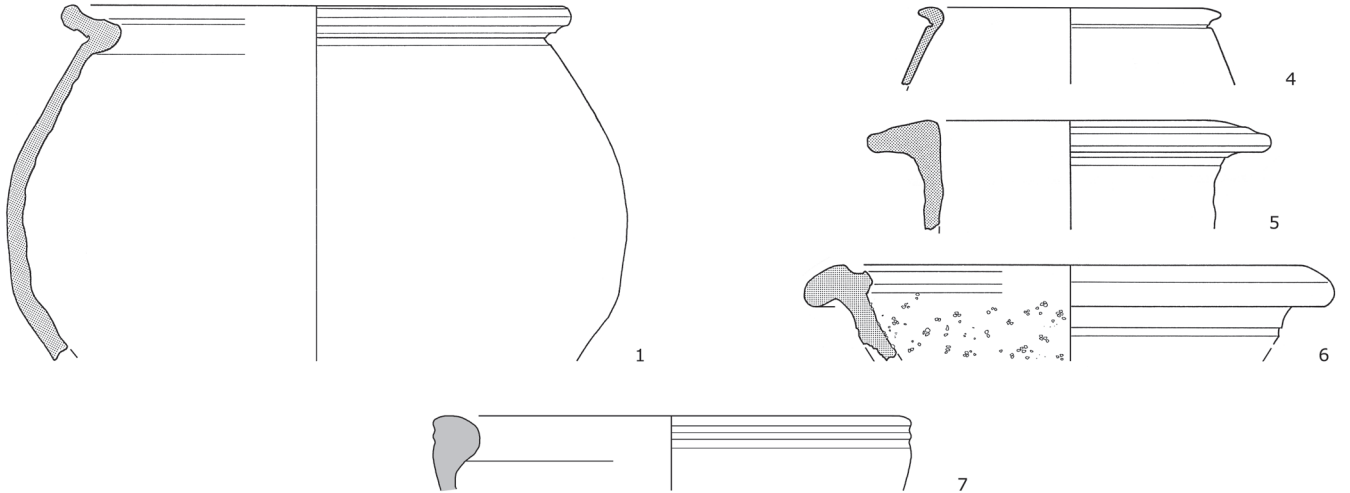

Grab 209

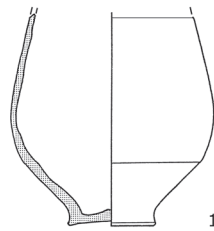

Grab 210



Glas
Nägel
Schuhnägel

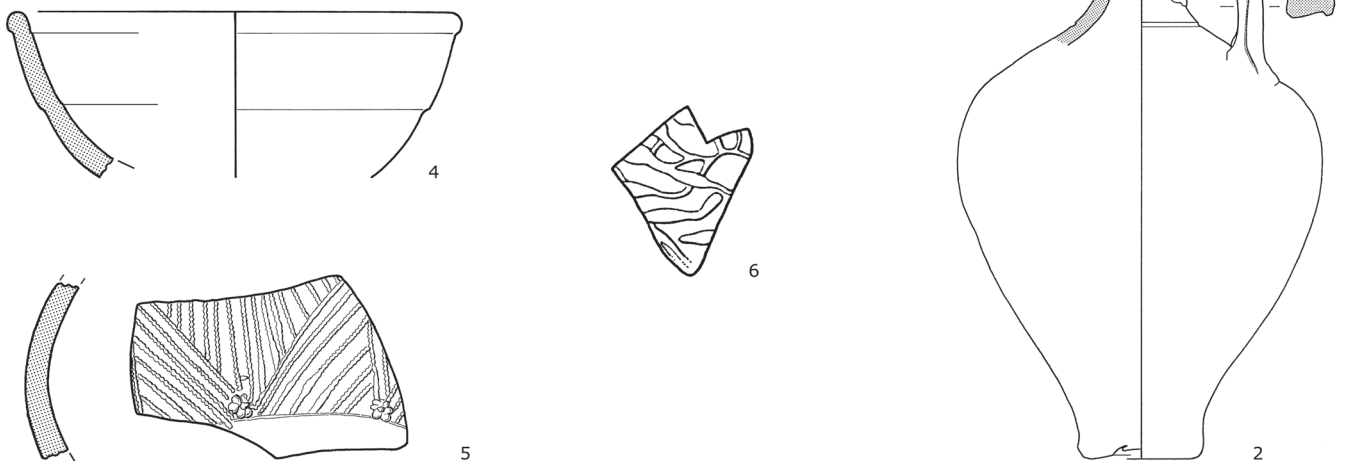

Grab 211



Schuh-nagel

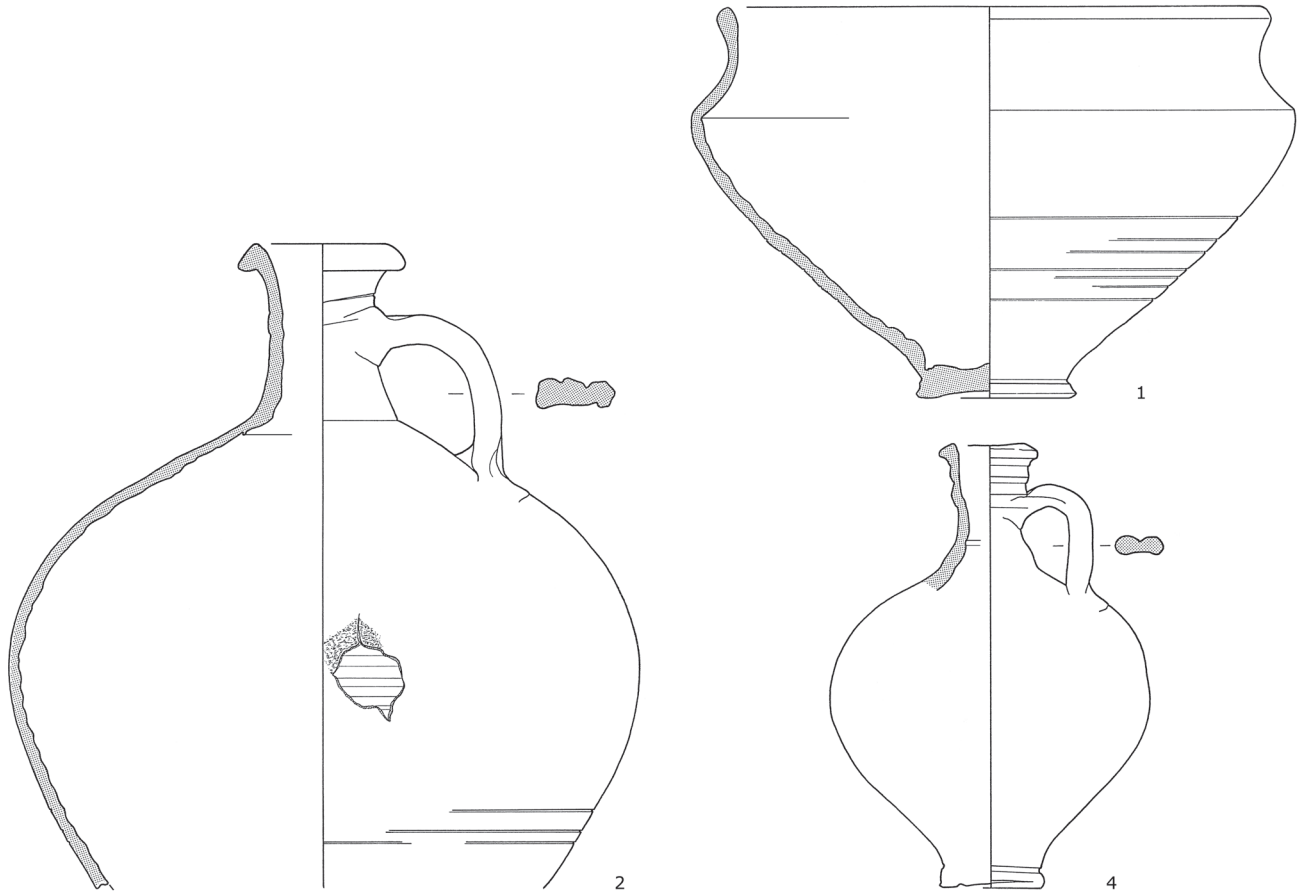

Grab 212



Schuh-nagel
Nägel

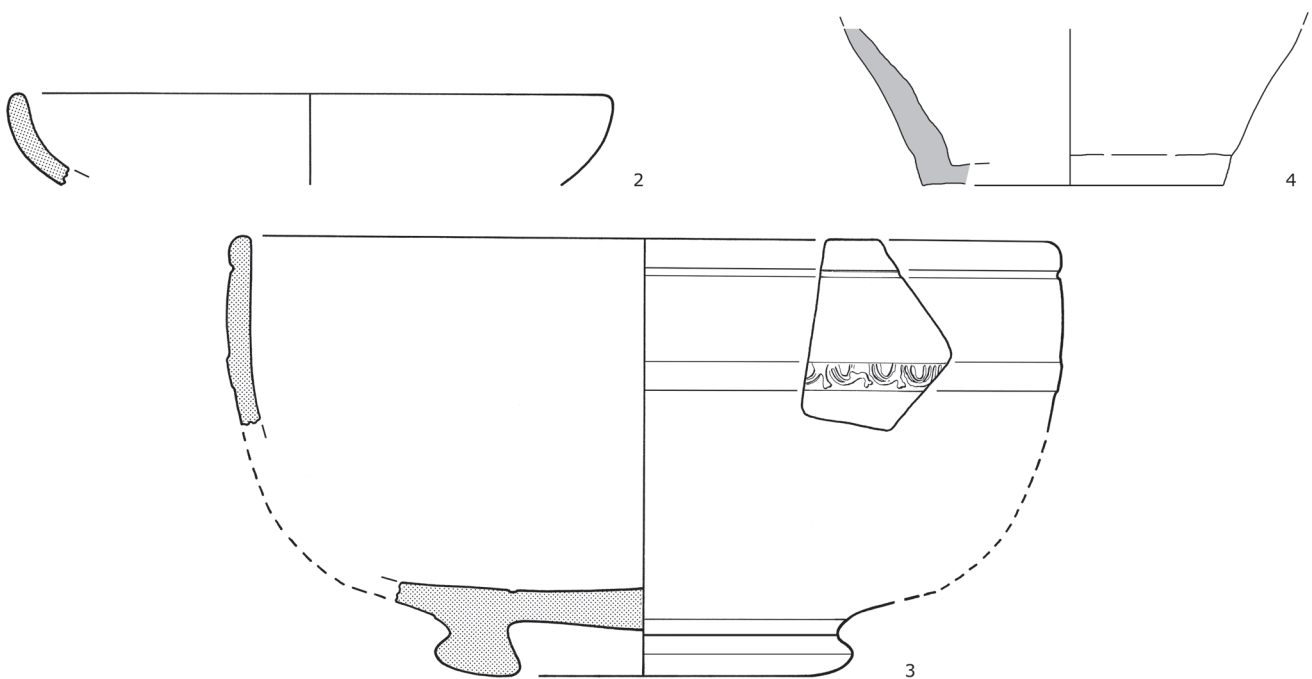

Grab 213



Grab 214



Nagel

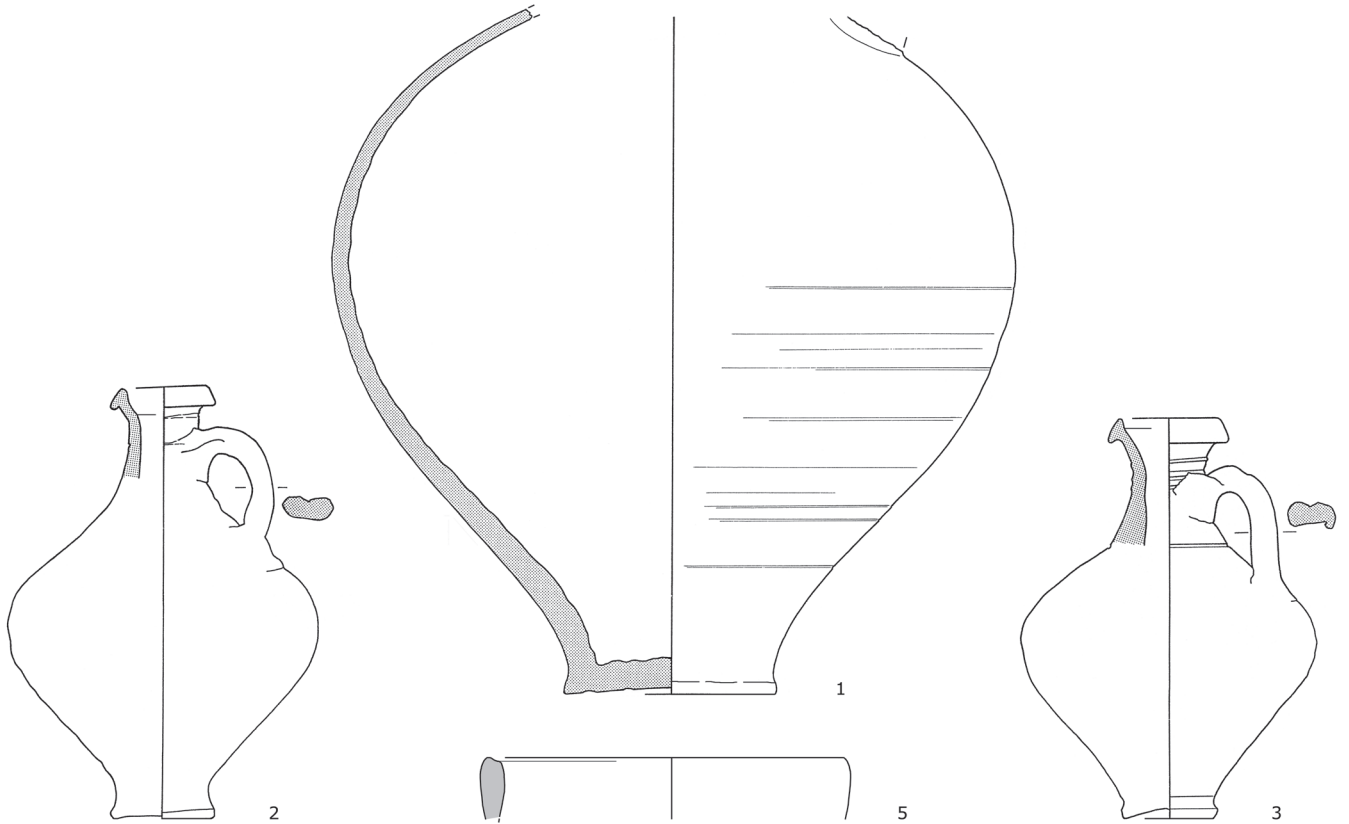

Grab 215



Nagel

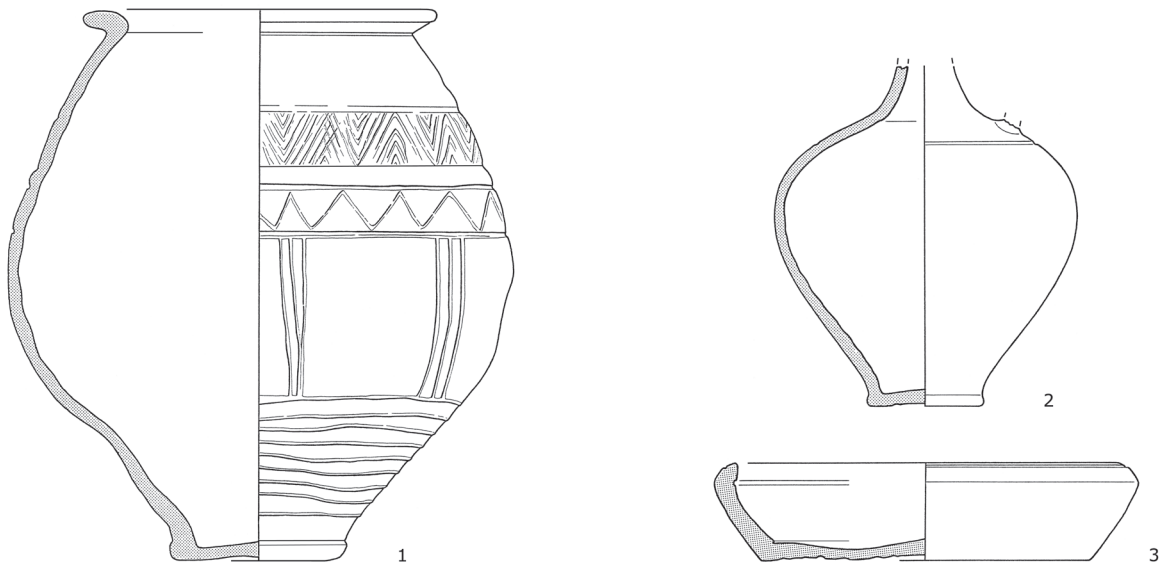

Grab 216



Glas
Nägel

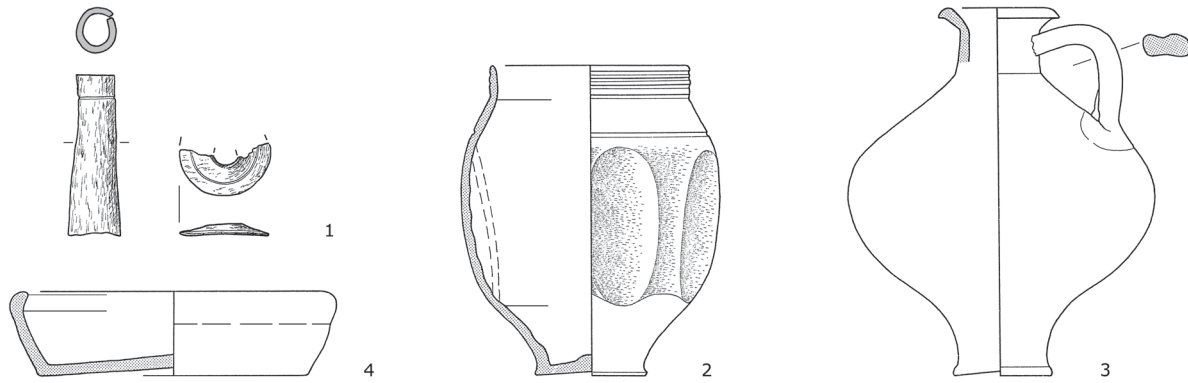

Grab 217



Grab 218



Nägel
Steinkugel

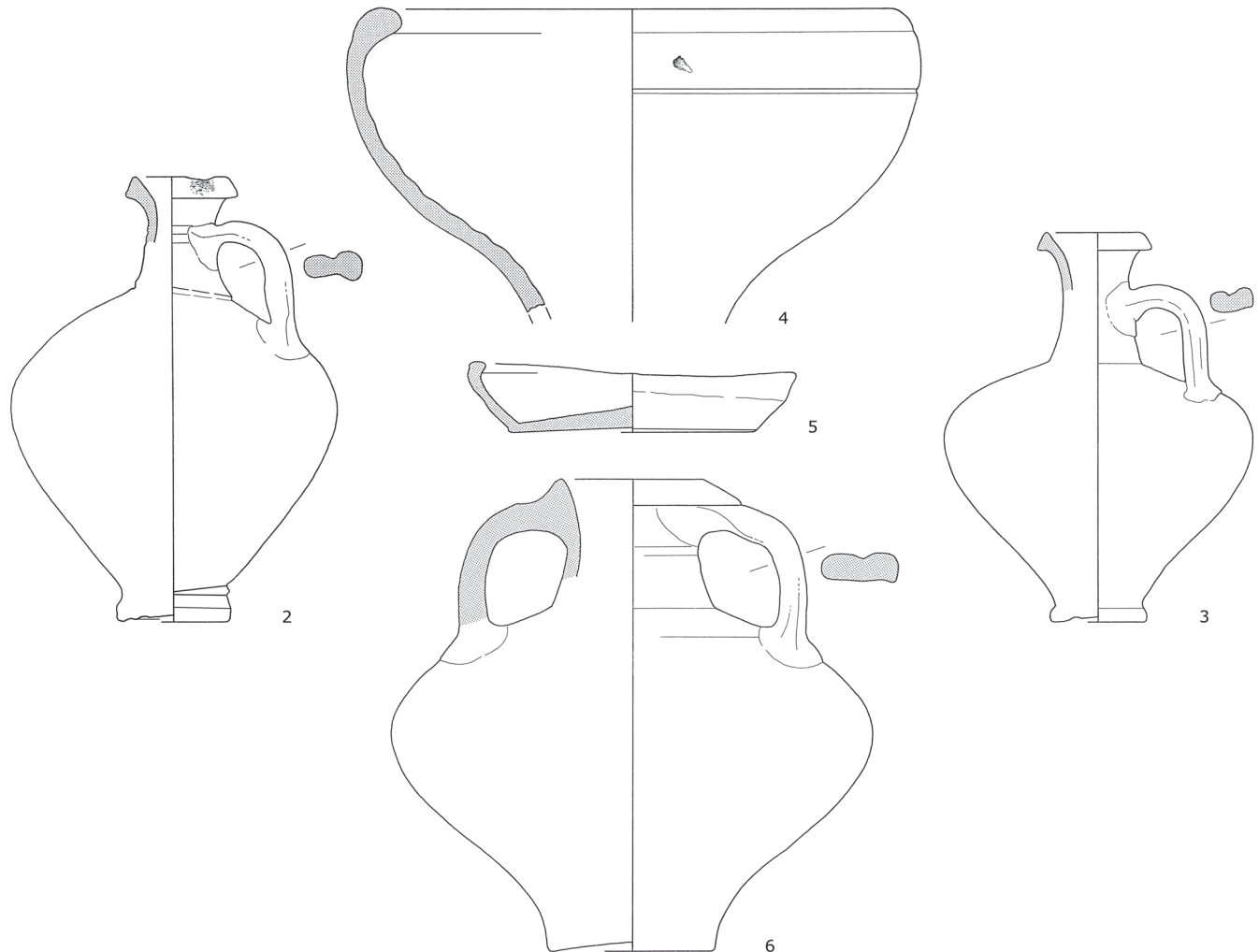

Grab 219

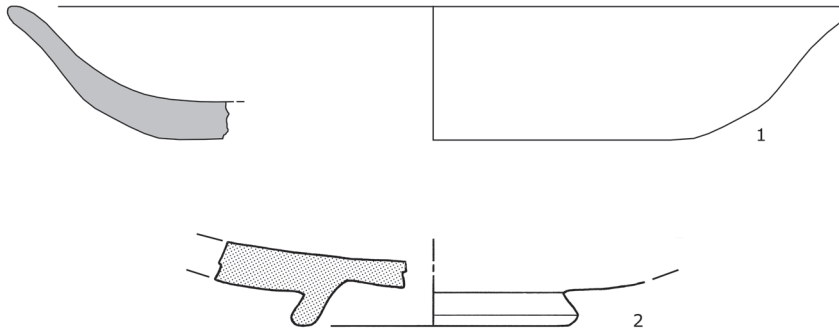

Grab 220



Nägel

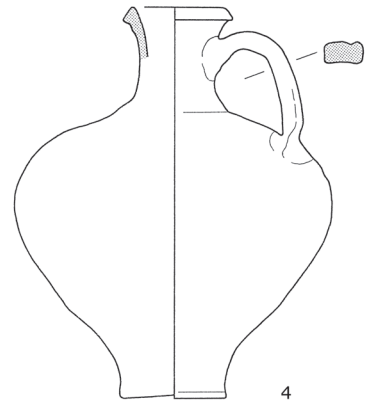
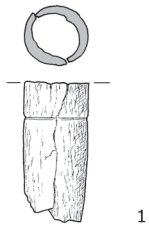

Grab 221



Nägel

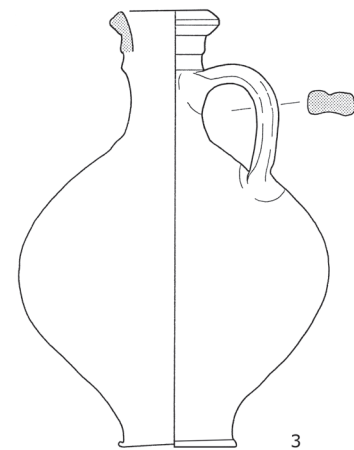
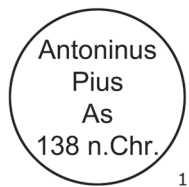

Grab 222



Grab 223



Nagel

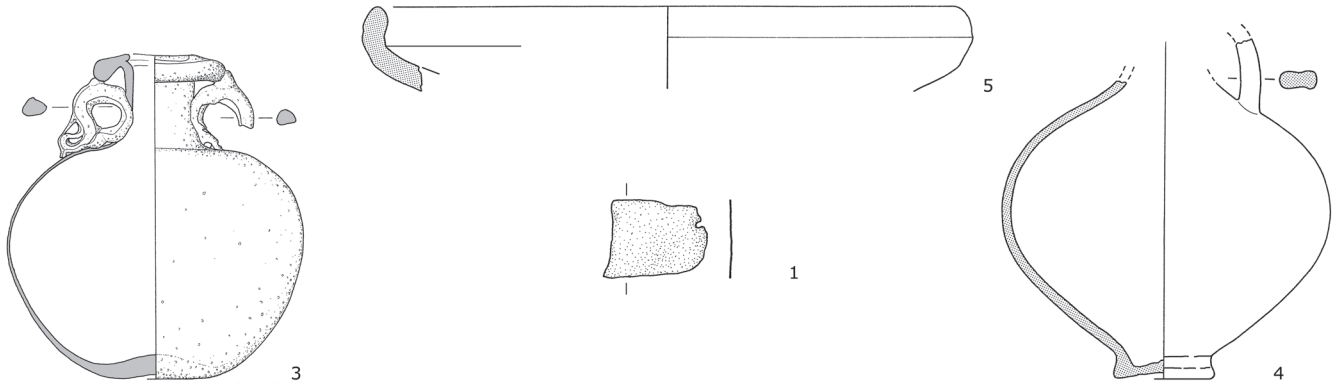

Grab 224



Schuhnagel
Nagel
Glas

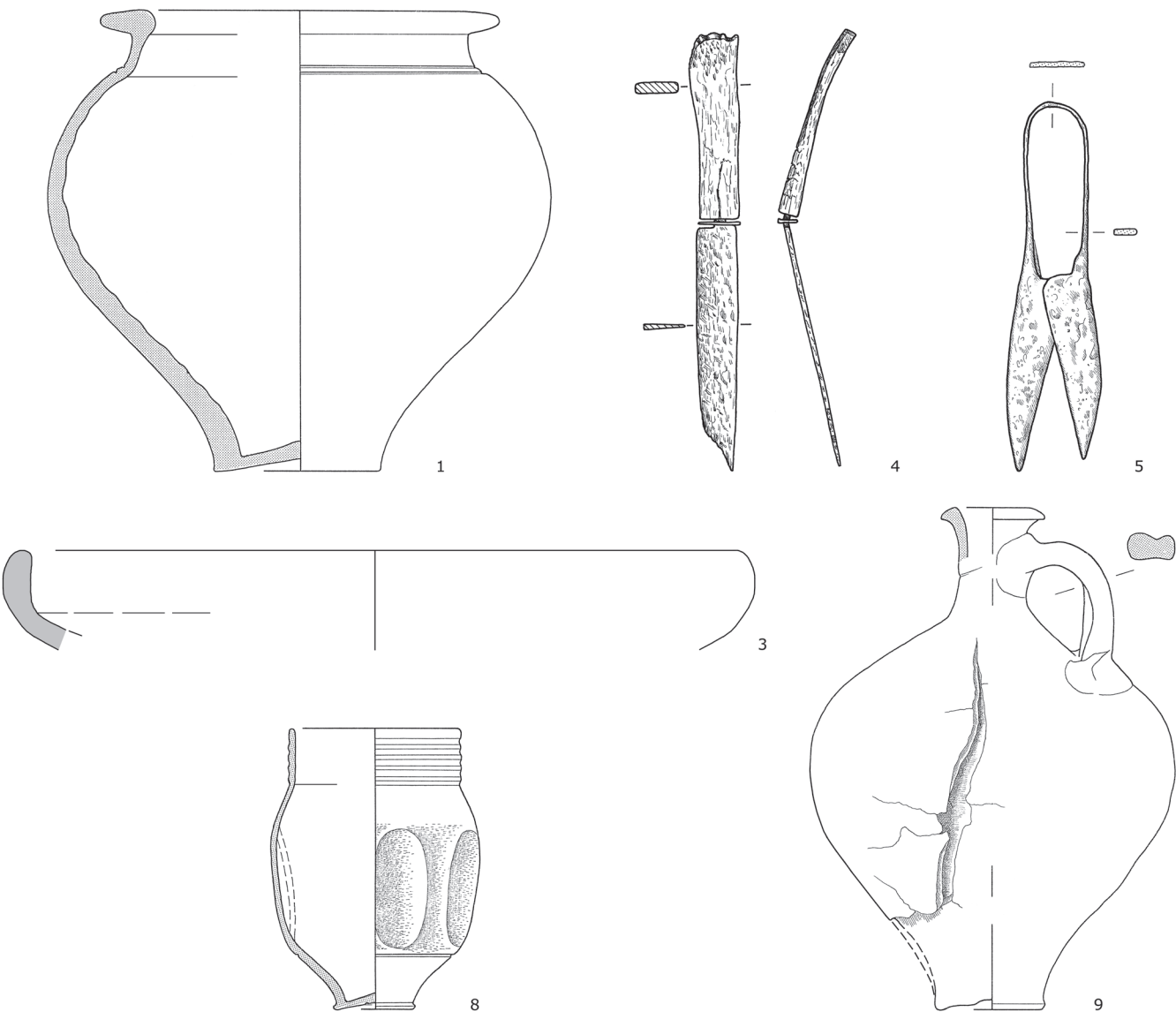

Grab 225



Glas
Nägel

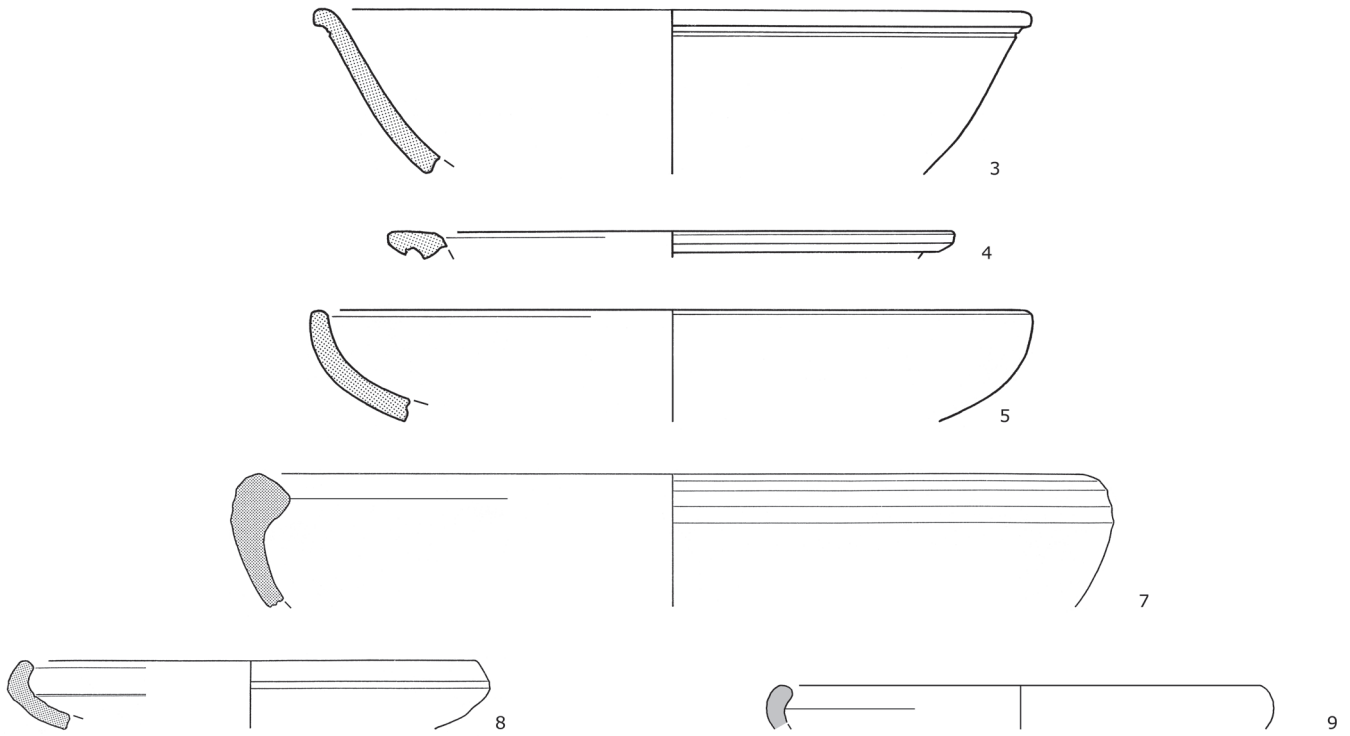

Grab 226



Nagel
Ziegel

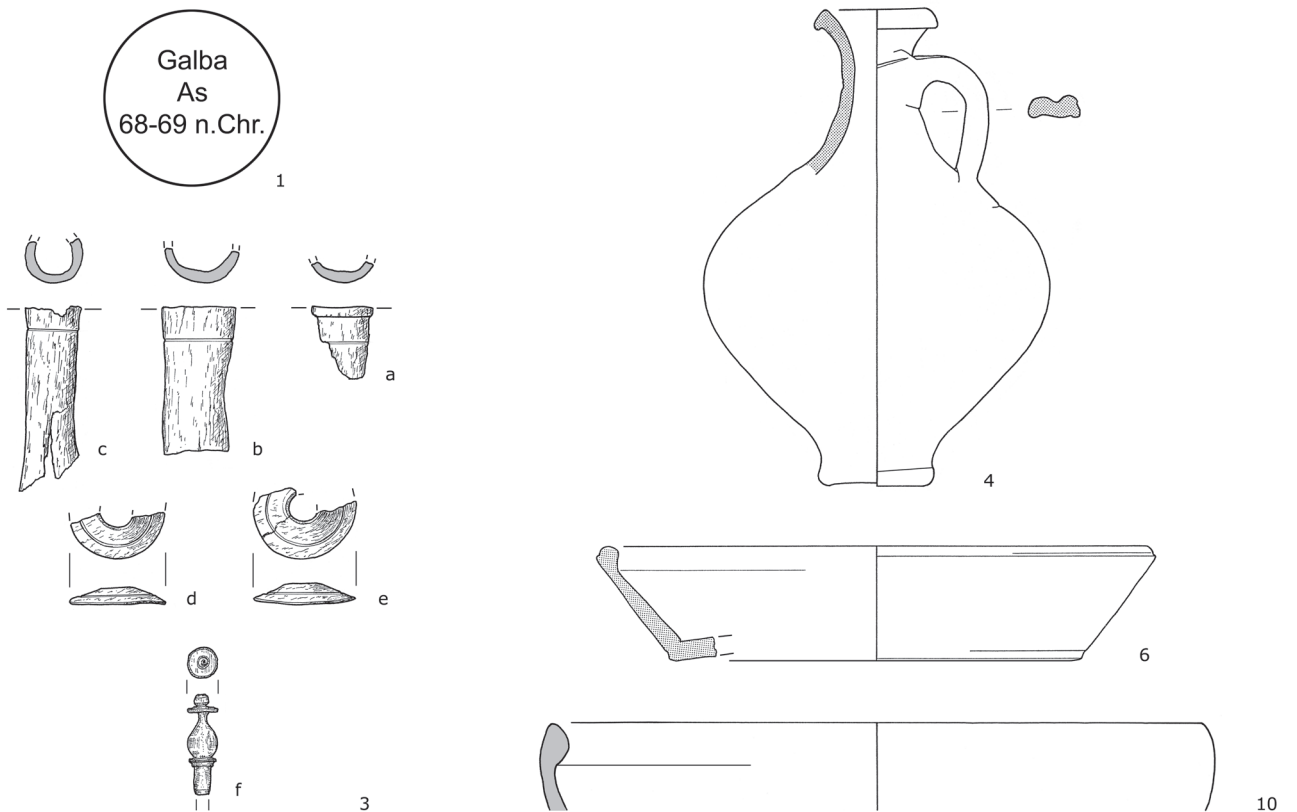

← Grab 226

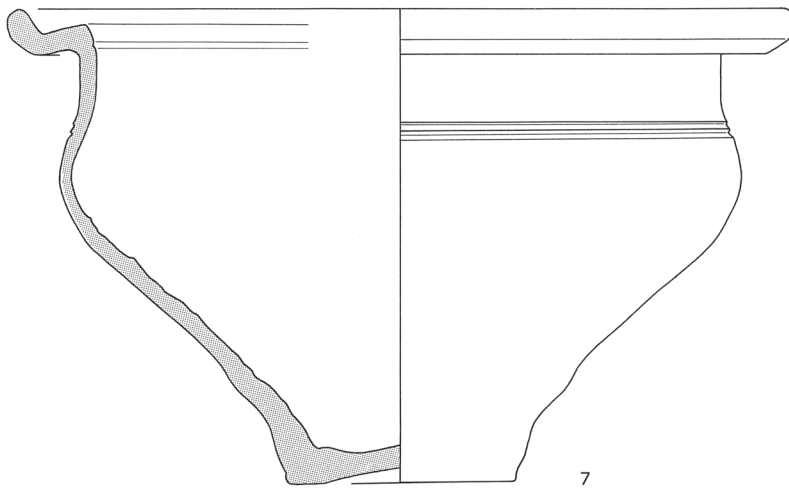

Grab 227



Nägel

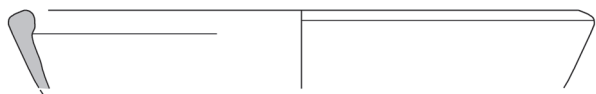
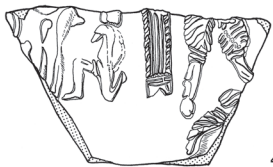
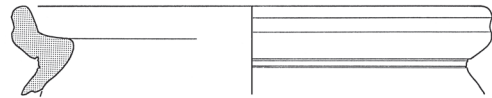

Grab 228

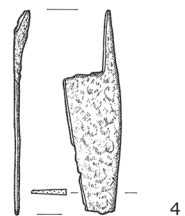
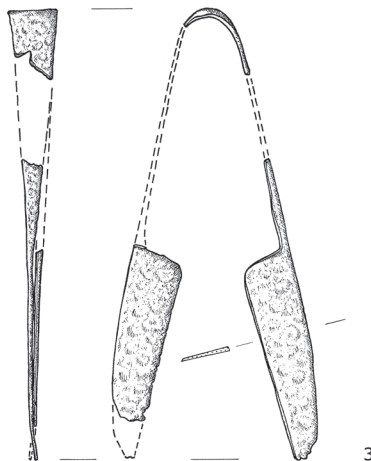
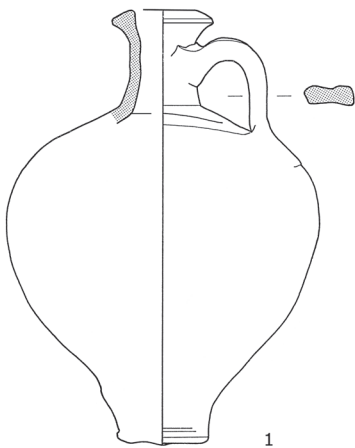

Grab 229



Nagel
Bronzeblech

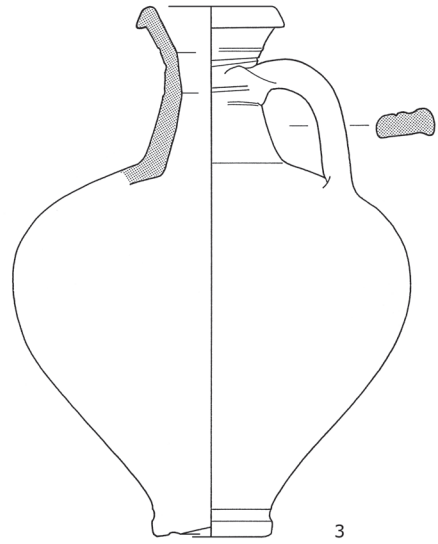
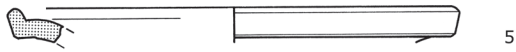
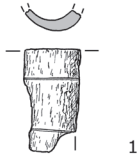

Grab 230



Grab 231



Nägel

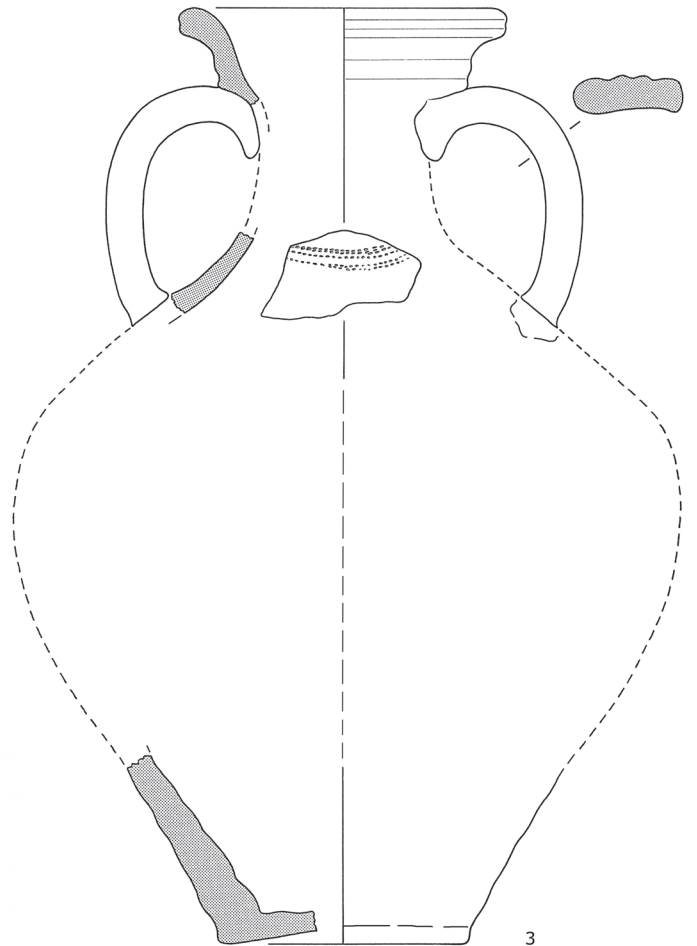

Grab 232



Nagel

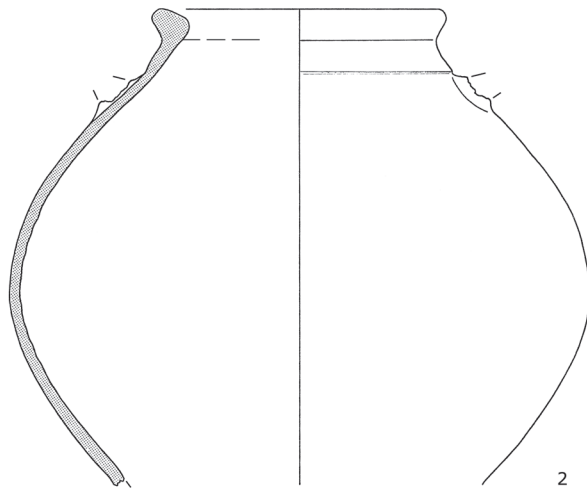

Grab 233 A



Nagel

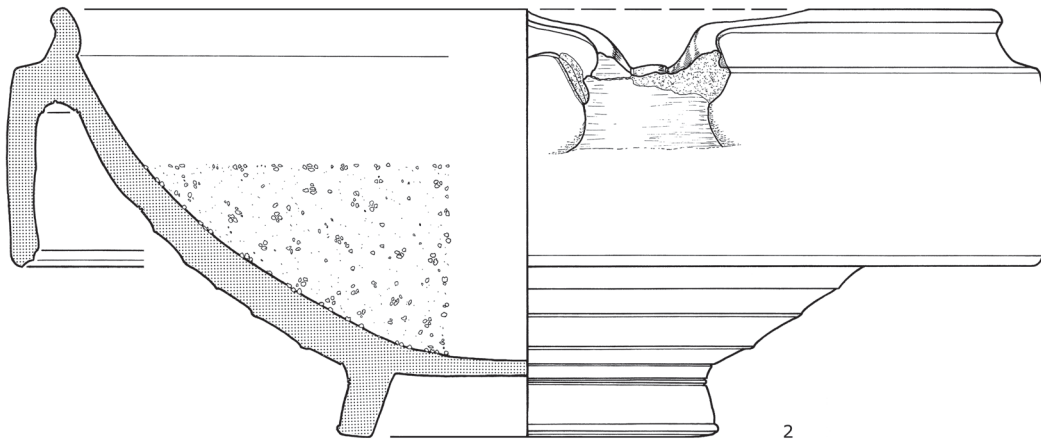

Grab 233 B

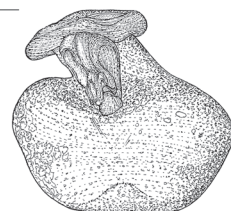
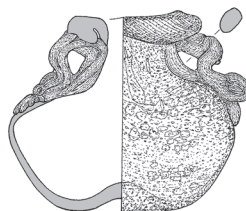
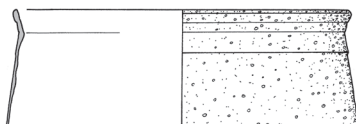
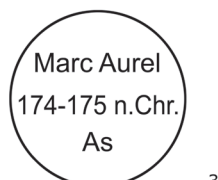
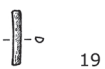
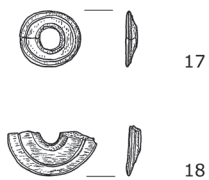
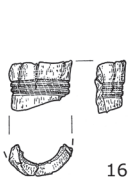

← Grab 233 B

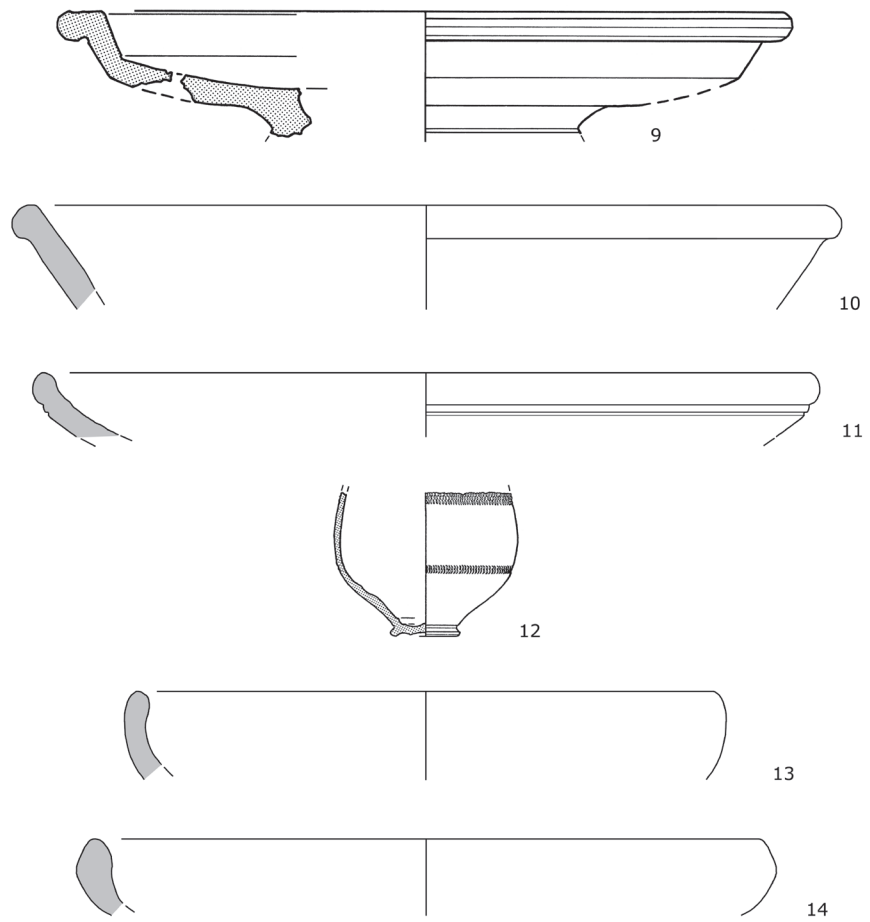

→ Grab 234

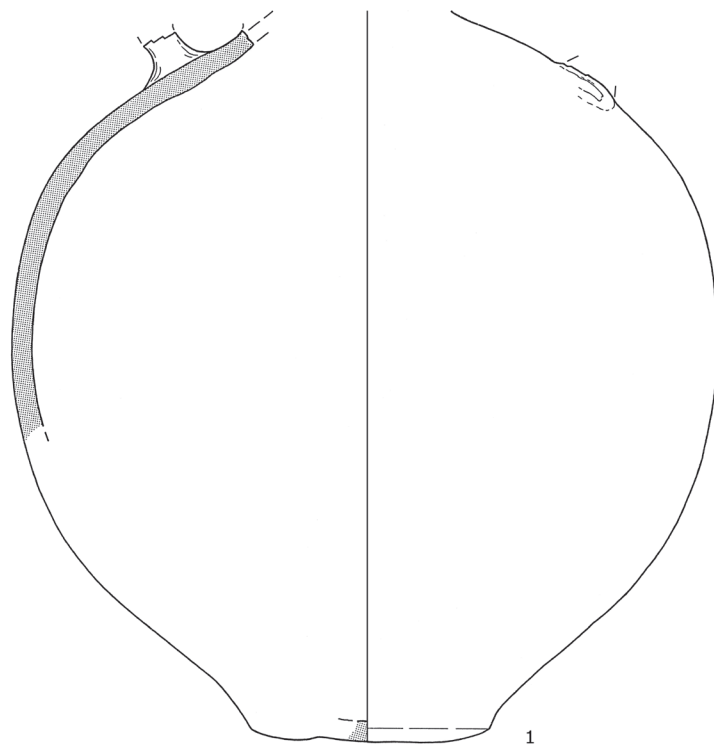

← Grab 234

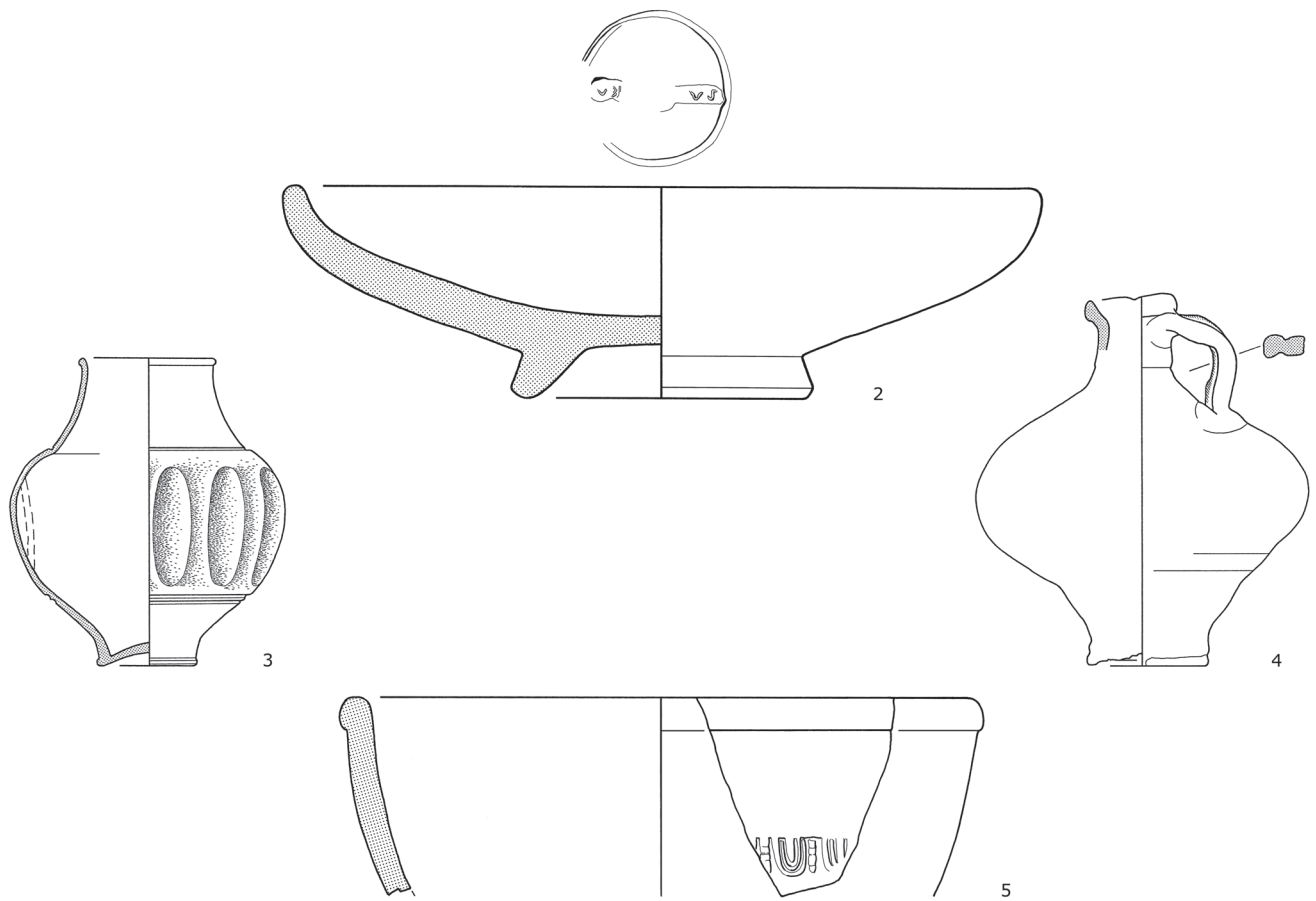

Grab 235



Nägel

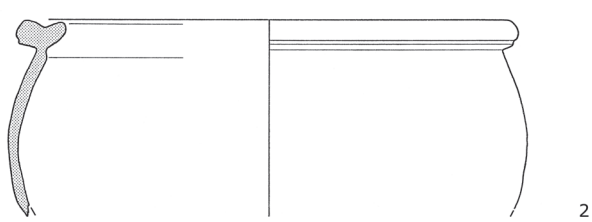

2

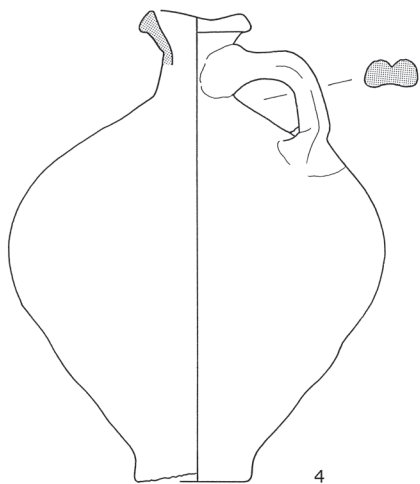

4

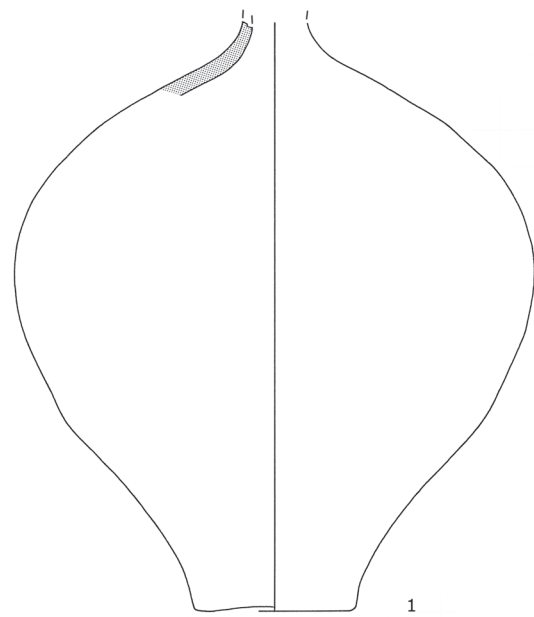

1

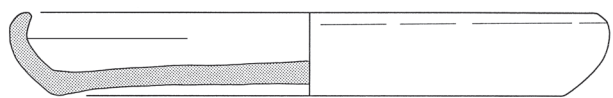

5

Grab 236



Grab 237



Nägel

Grab 238



Schuh
Nägel

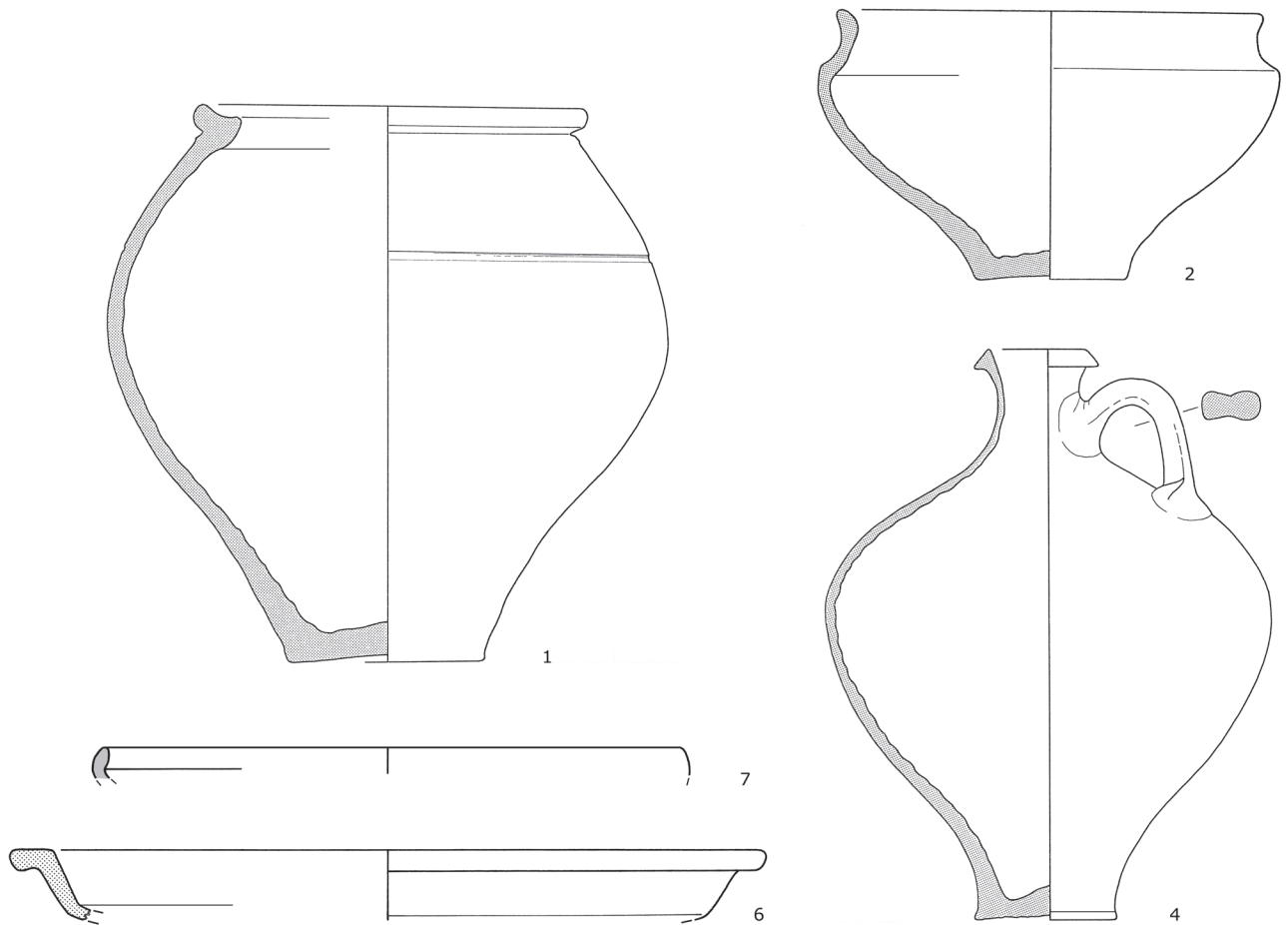

Grab 239



Nägel



2

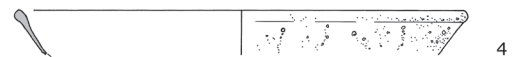

4

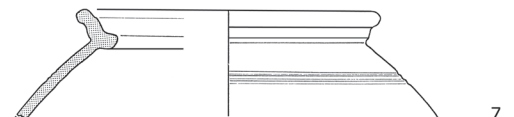

7

←
Grab 239

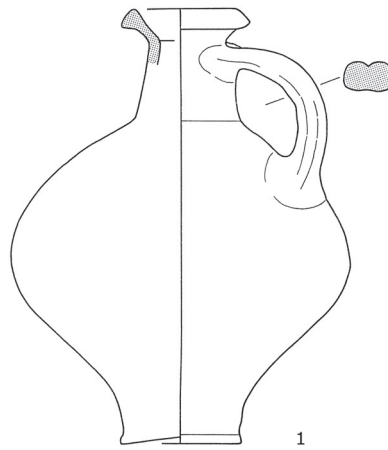

Grab 240



Nagel
Keramik

Grab 241



Keramik

Grab 242



Schuhnagel
Keramik

Fundstelle 243

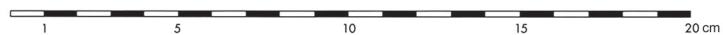
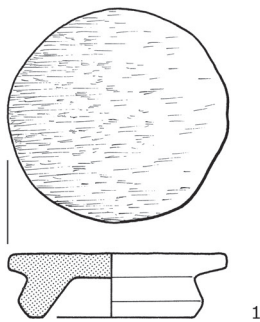

Grab 244



Schuhnägel



1

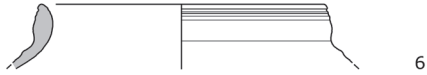

6

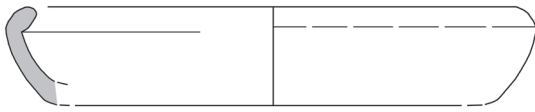

7

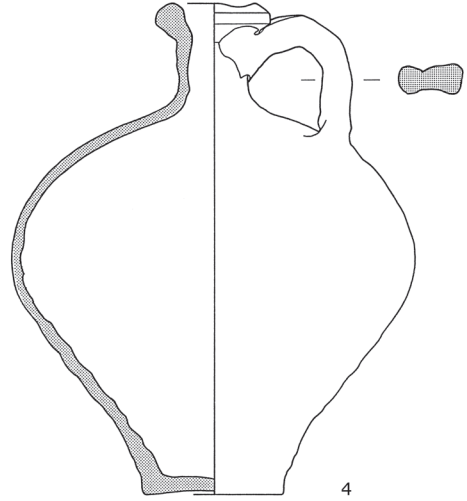

4

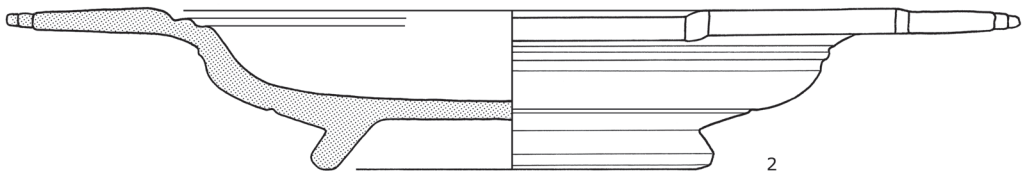
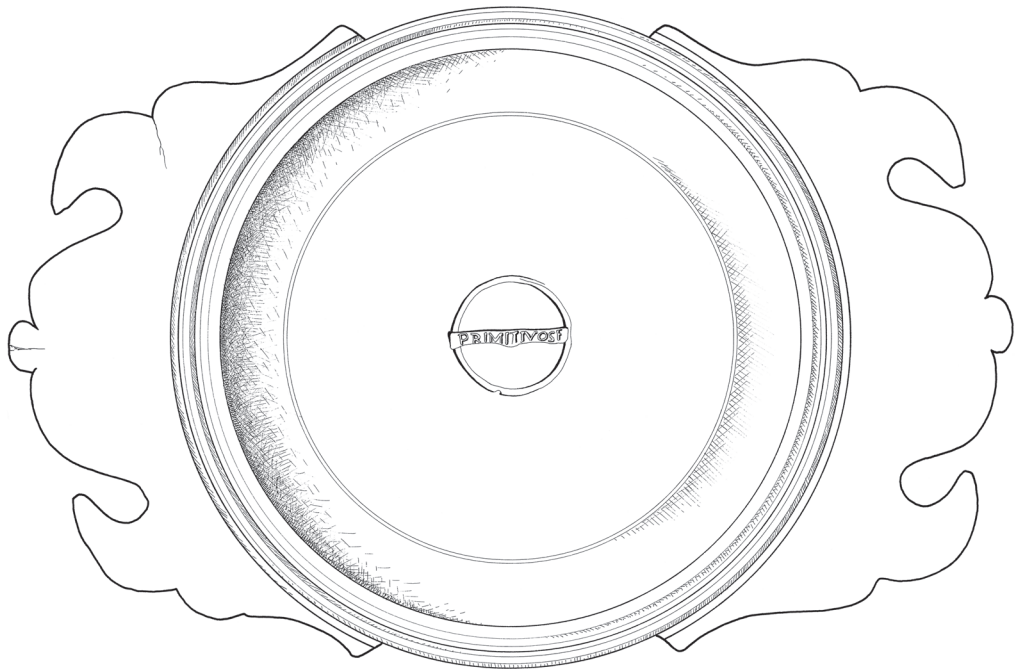

2

Grab 245

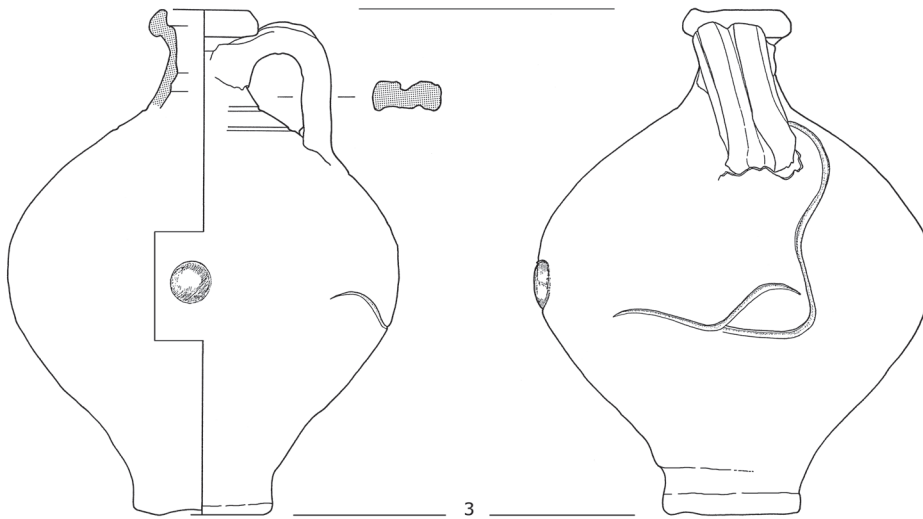
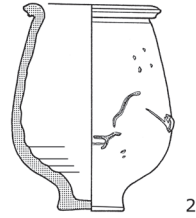
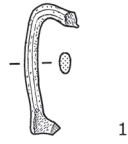

Grab 246

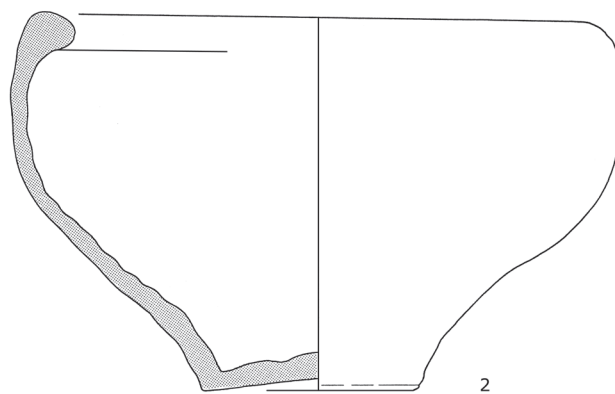
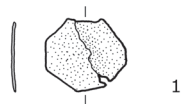

Grab 247

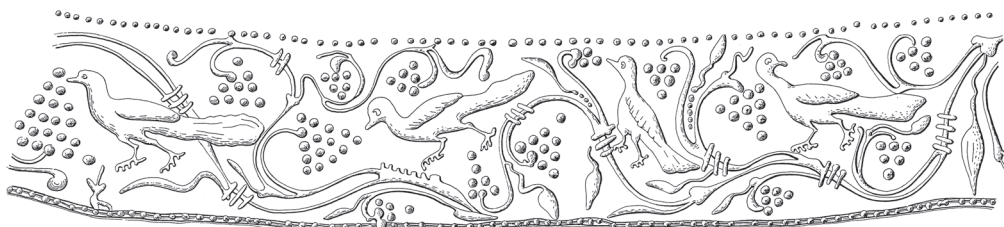
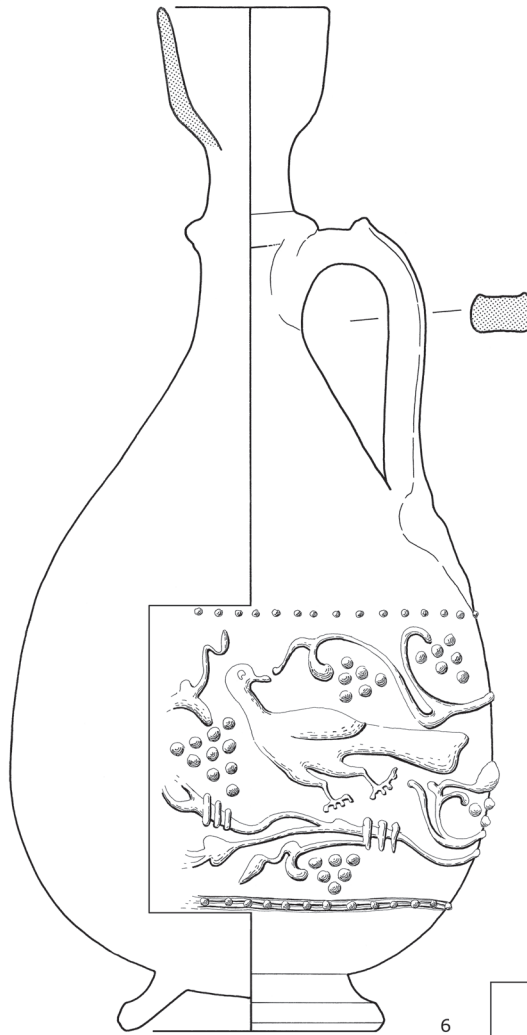
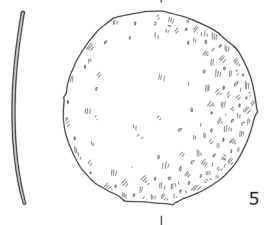
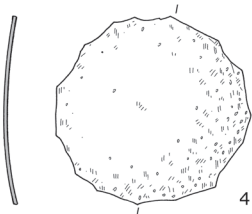
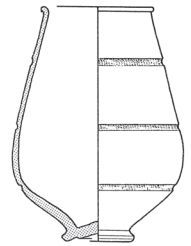
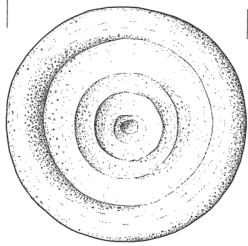
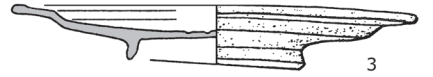
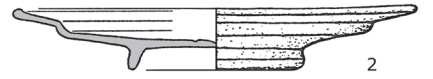
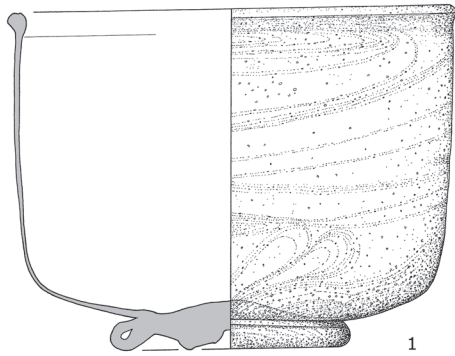
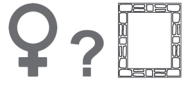

Grab 248



Schuhnagel
Bronzeblech

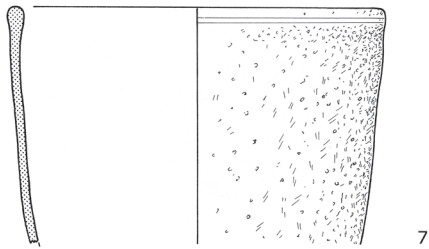
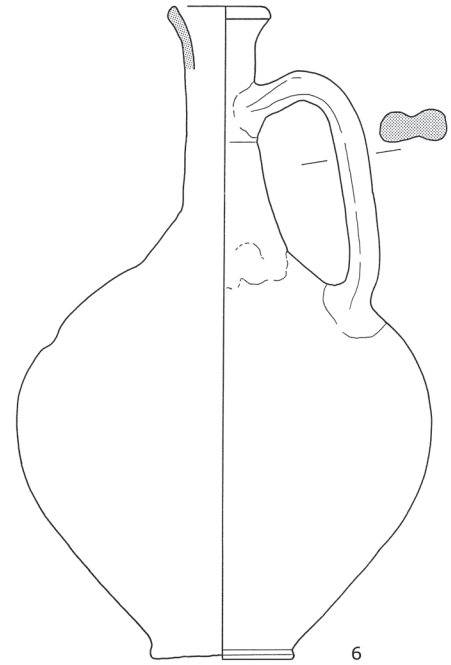
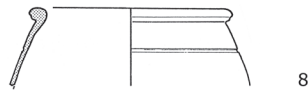
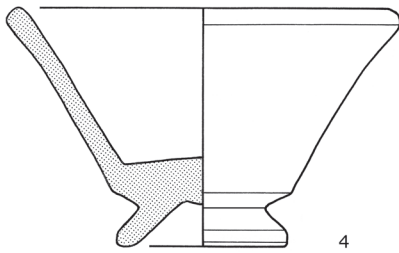
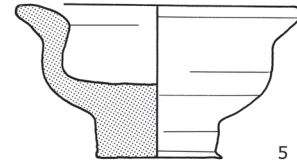
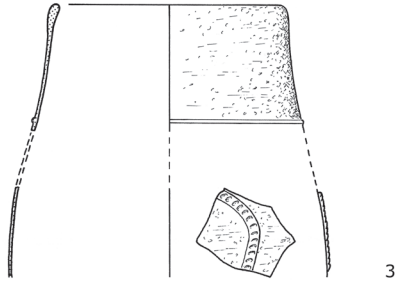

Fundstelle 249

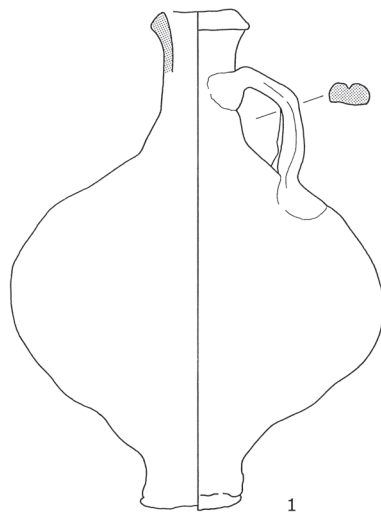

Grab 250



Nägel

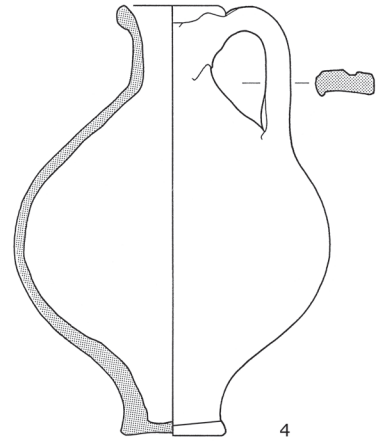
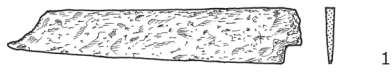

Grab 251



Nägel

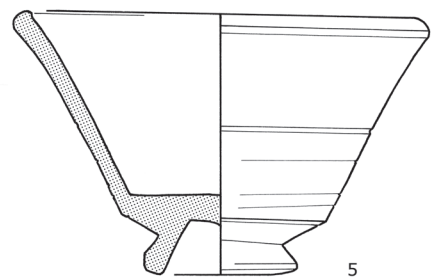
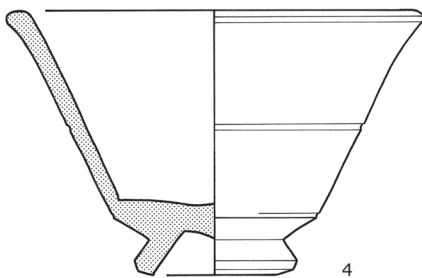
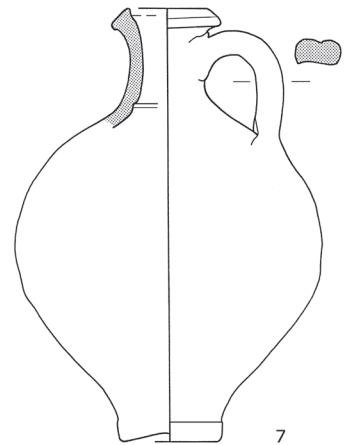
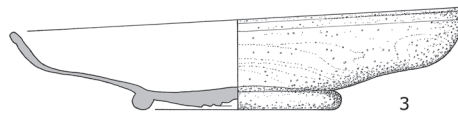
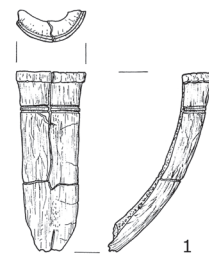
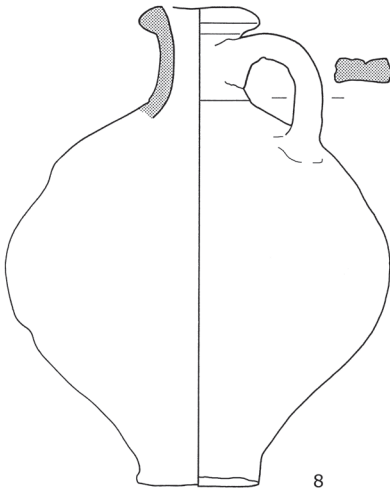
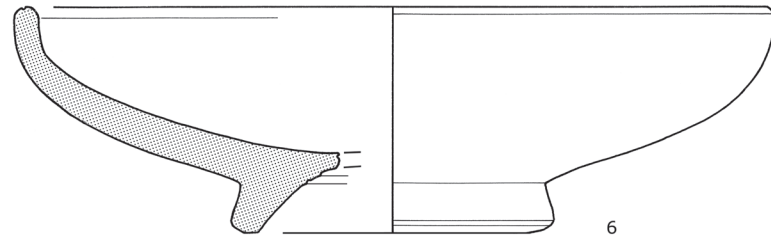

Grab 252



1

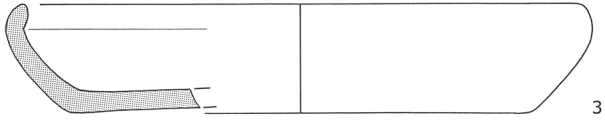

3

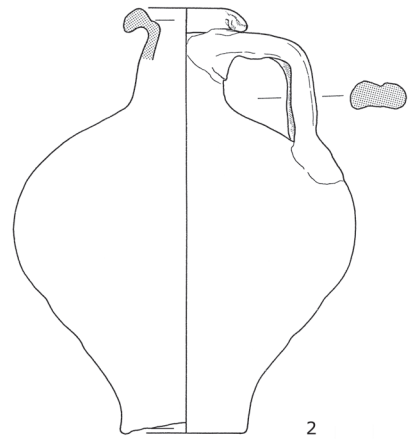

2

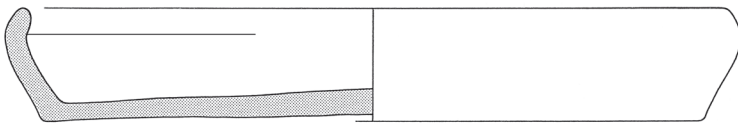

4

Grab 253



Schuhnagel
Nagel

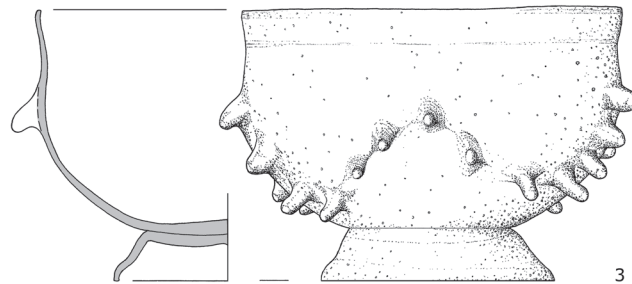

3

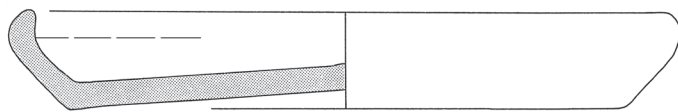

5

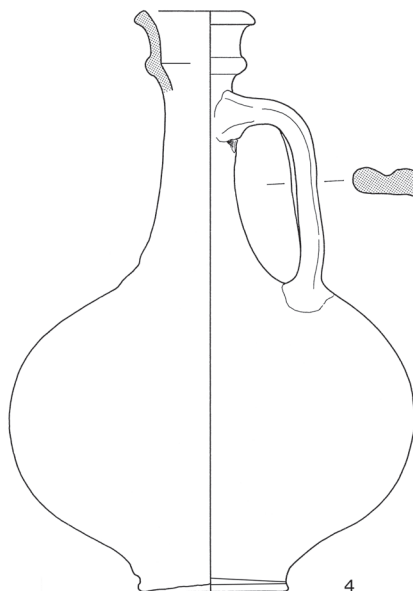

4

Grab 254



Nägel

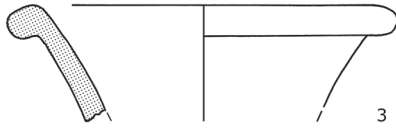

3

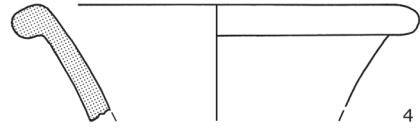

4



8

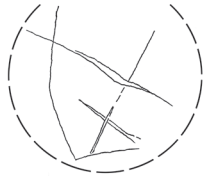

5

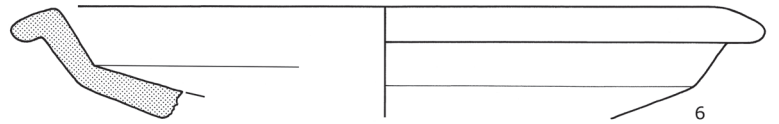

6

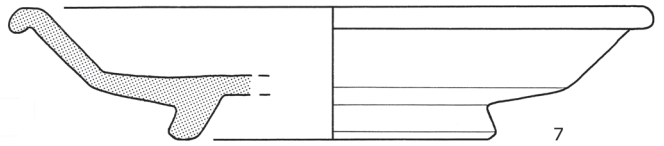

7

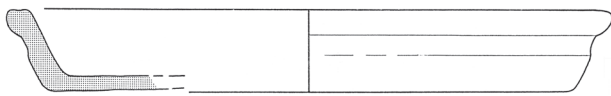

12

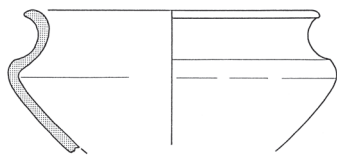

11

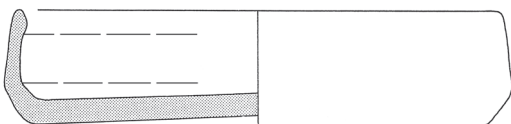

13

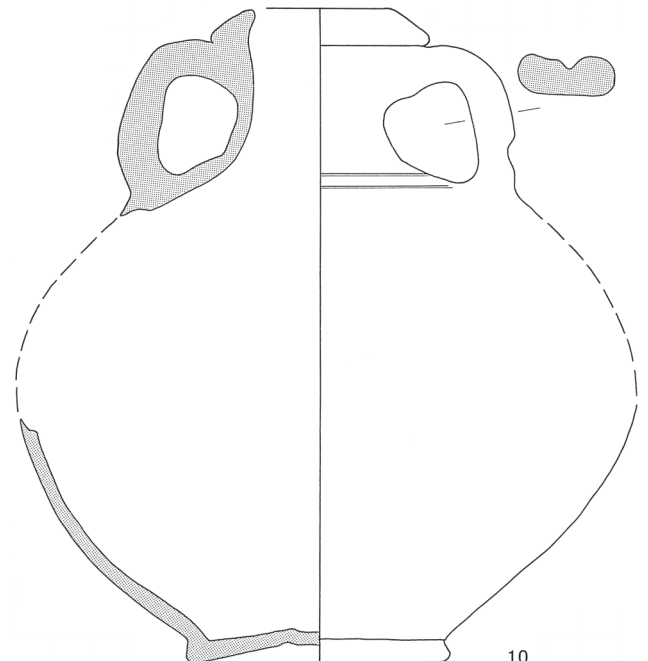

10

Fundstelle 254/255
Zwischenbereich



Eisenschlacke

Grab 255



Nagel

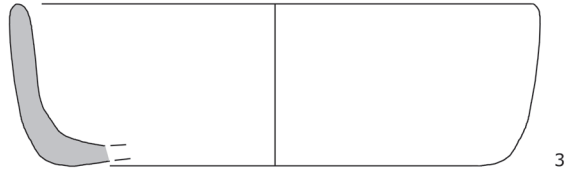
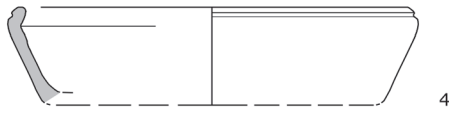

Grab 256 A



Glas
Nägel
Bronzeblech

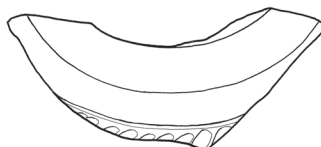
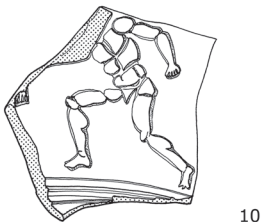
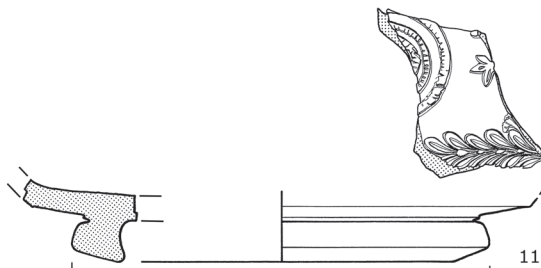
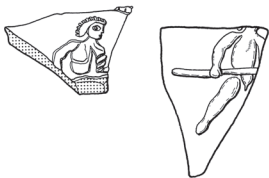
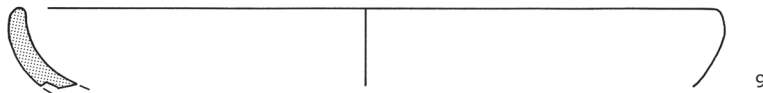
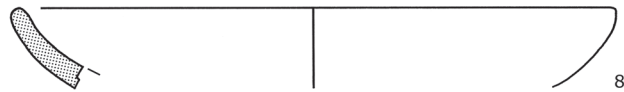
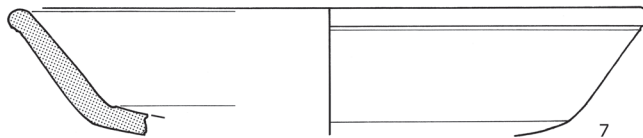
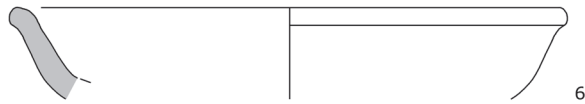
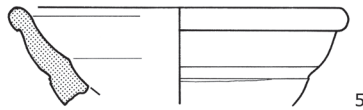
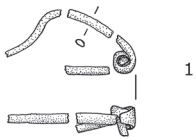

← Grab 256 A

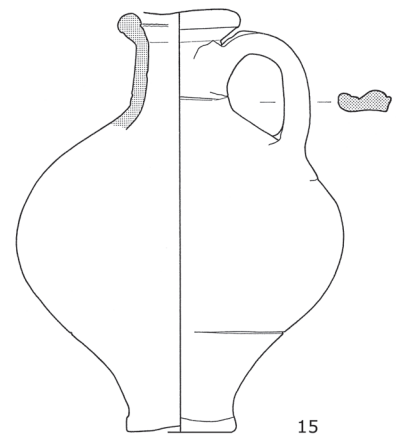
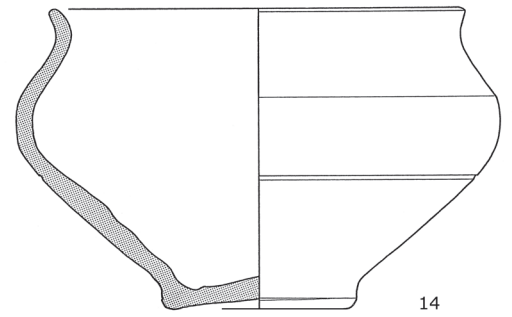
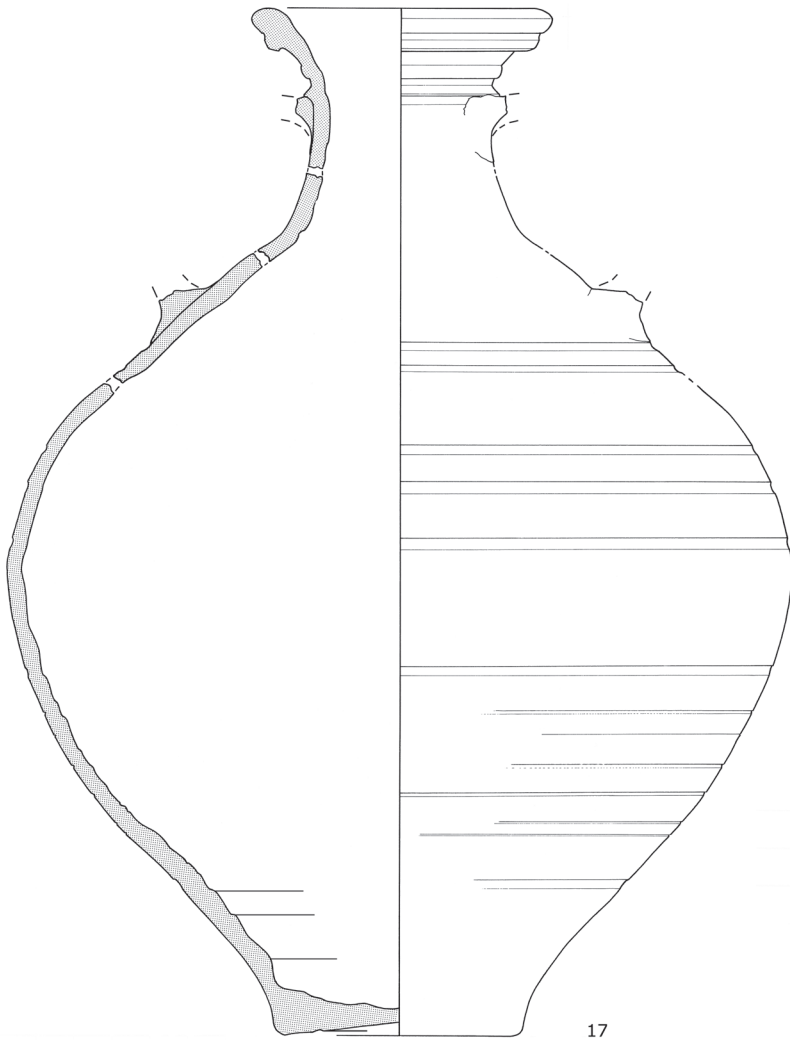
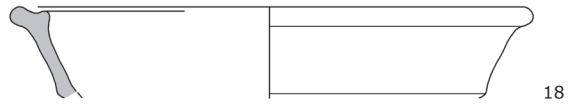

Grab 256 B ♂?



20

Fundstelle 256 A/256 B
Zwischenbereich



Ziegel

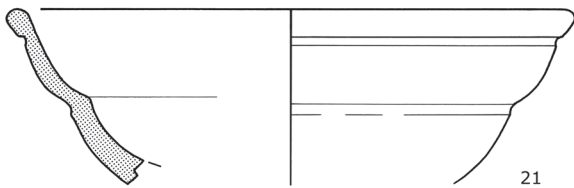

21

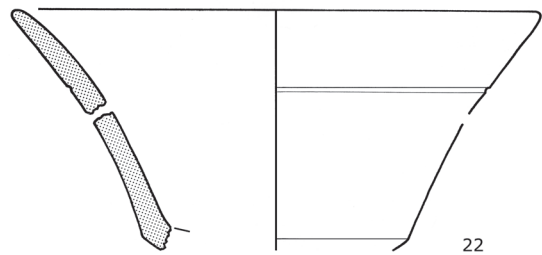

22

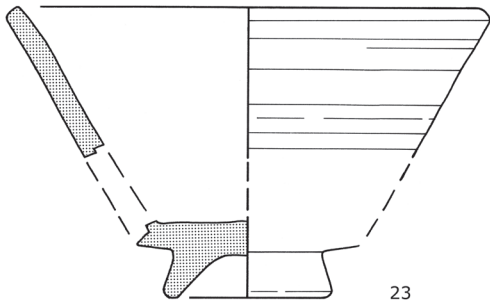

23



24

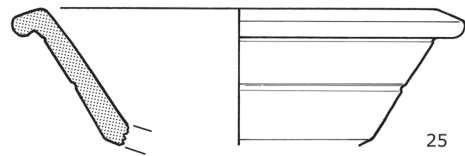
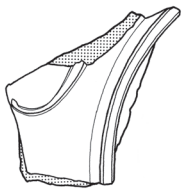

25

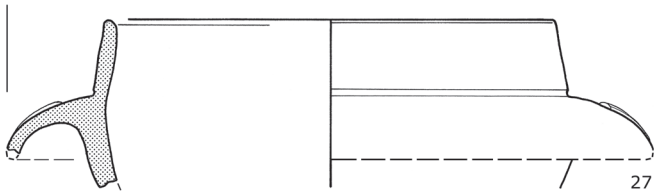

27

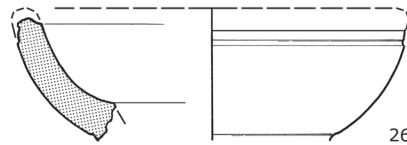

26

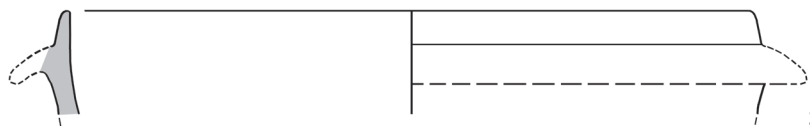

28

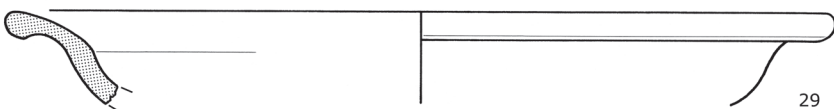

29

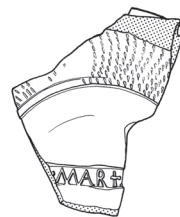

30



33



32



31

Fundstelle 256 A/256 B
Zwischenbereich

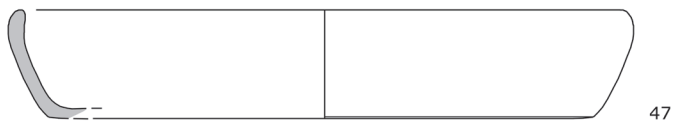
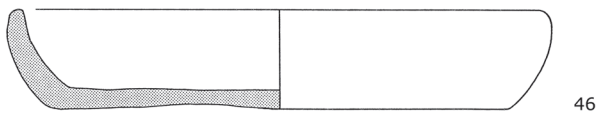
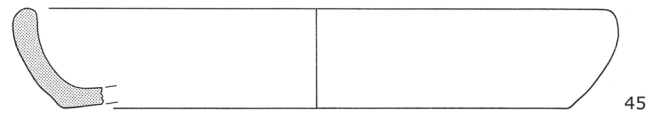
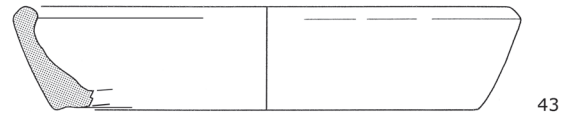
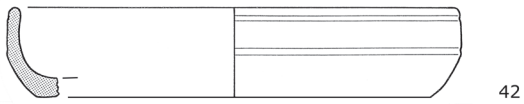
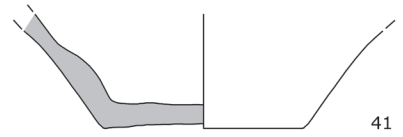
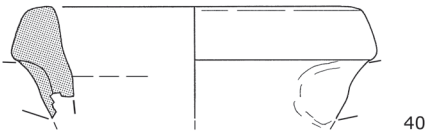
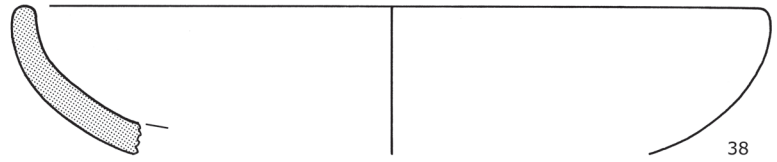
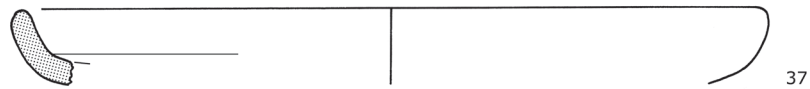
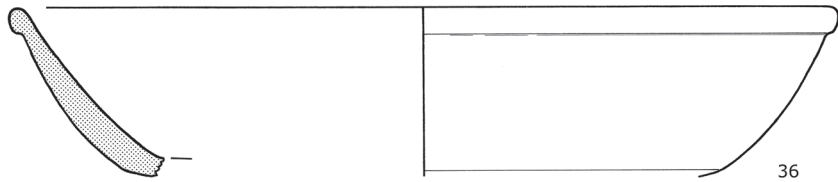
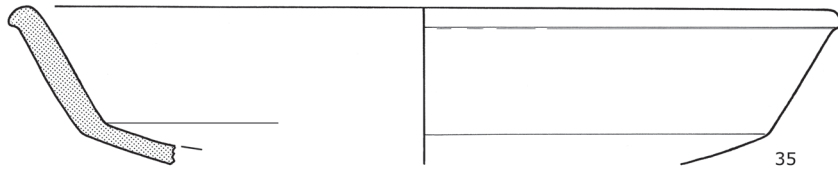
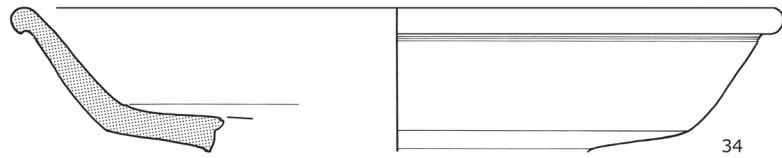

←←
Fundstelle 256 A/256 B
Zwischenbereich

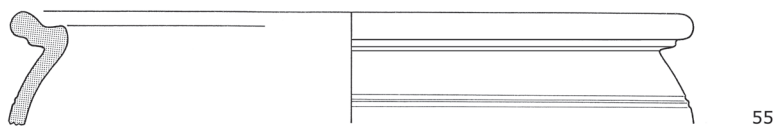
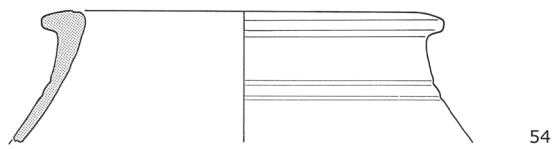
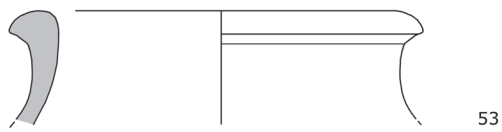
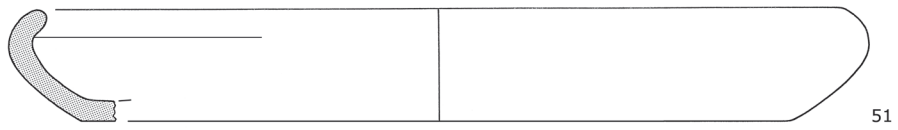
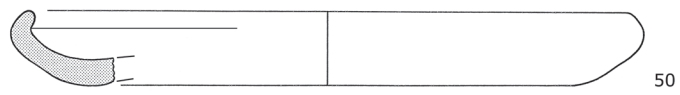
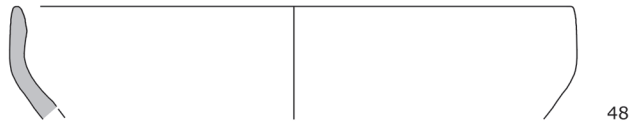

Grab 257



Schuhnagel

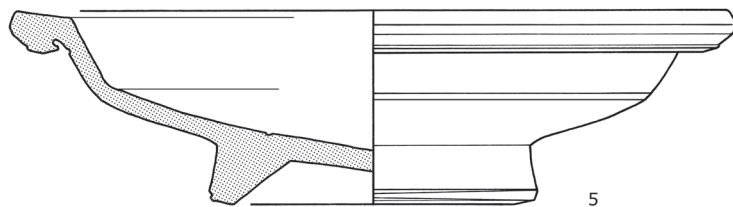
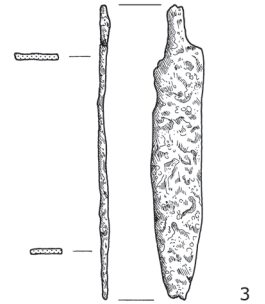
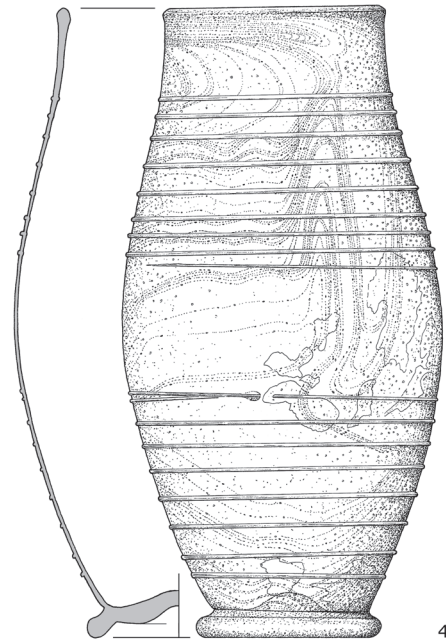
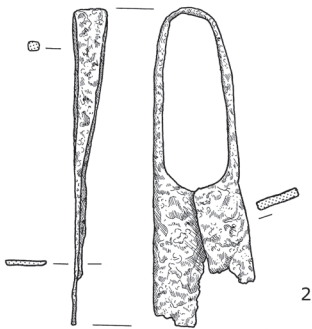
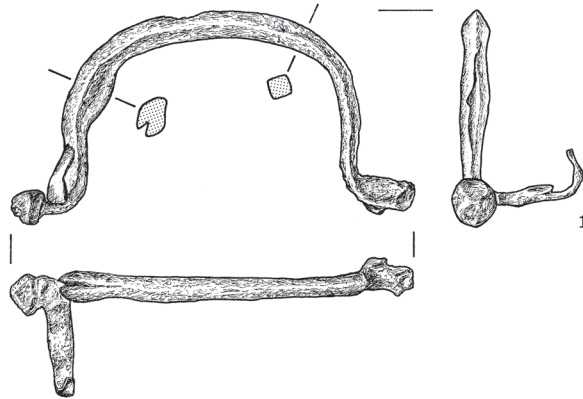

Grab 258 A

♂ ♀ ?

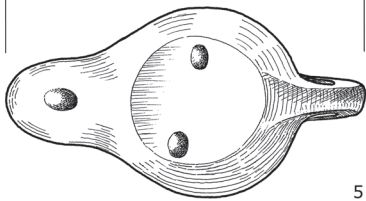
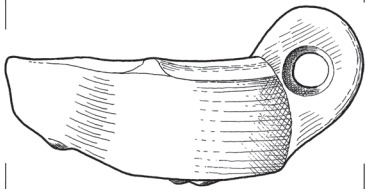
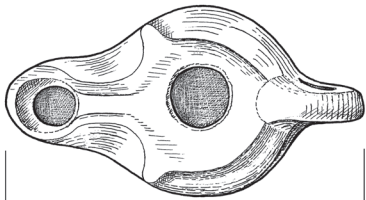

5

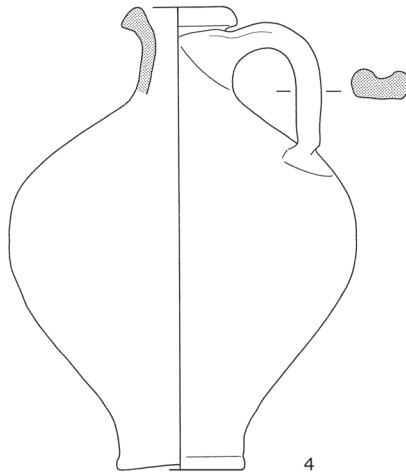

4

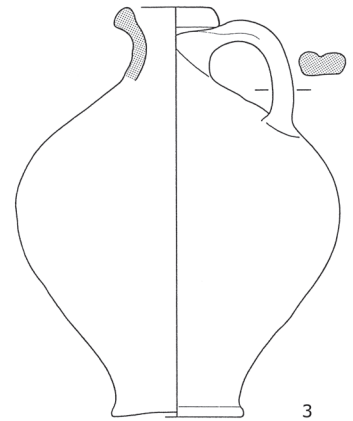

3

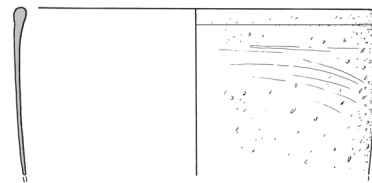

2

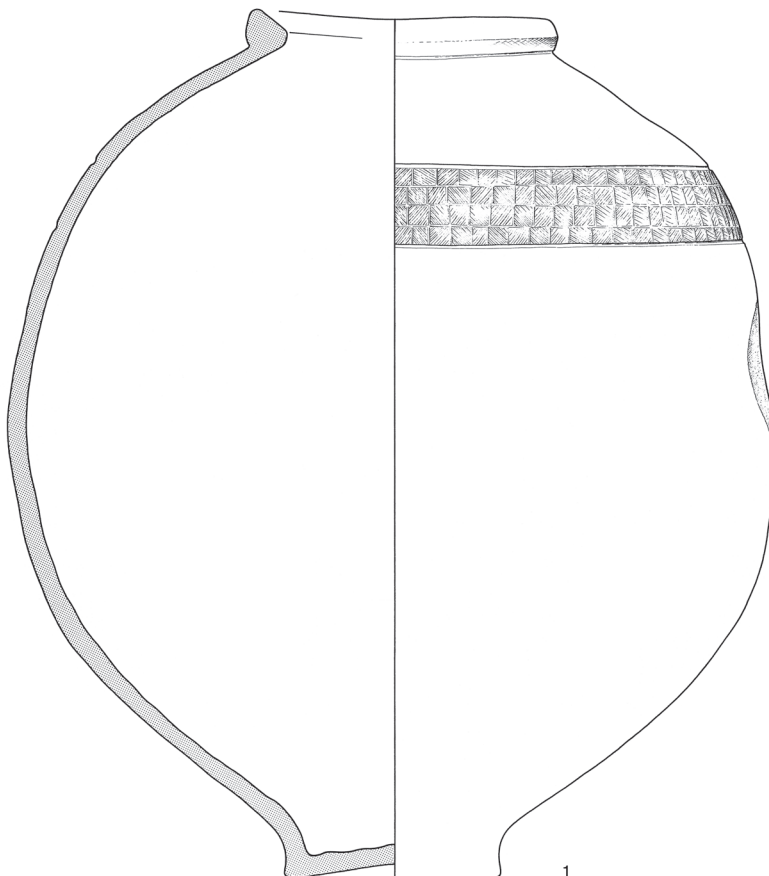

1

← Grab 258 A

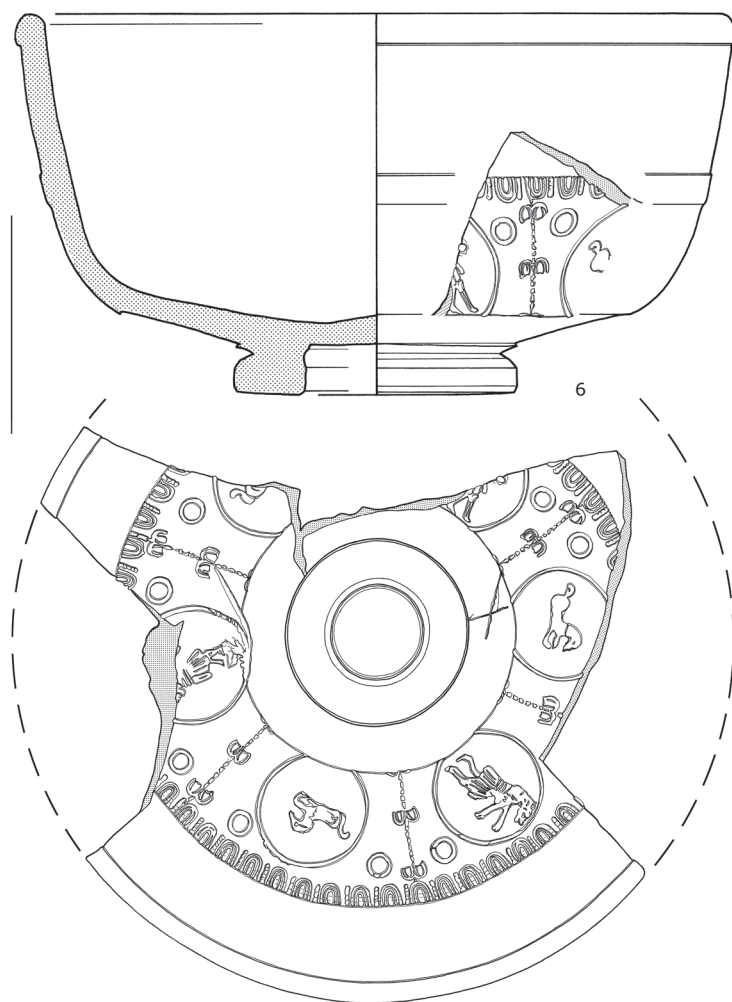

→ Grab 258 B

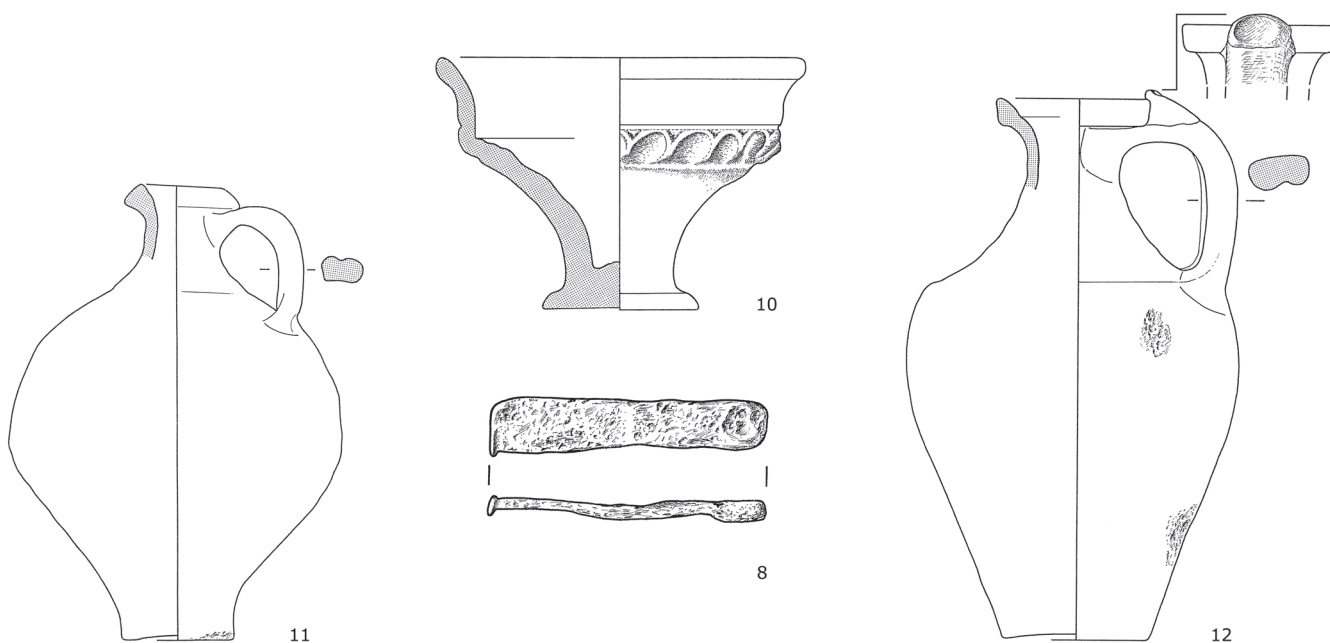

←
Grab 258 B

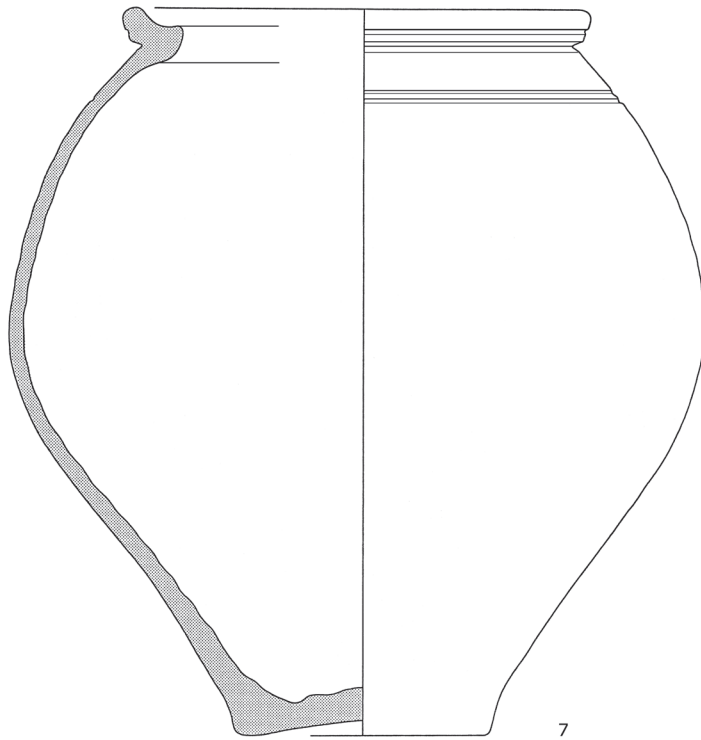

Fundstelle 259

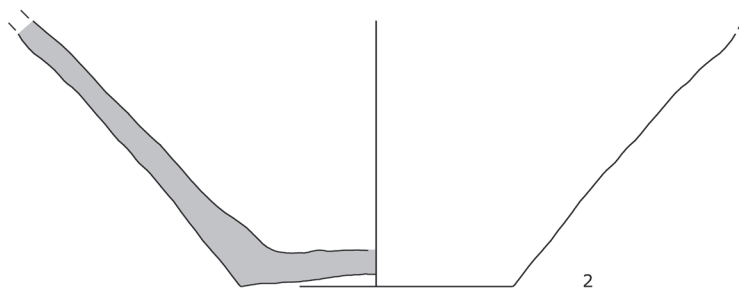
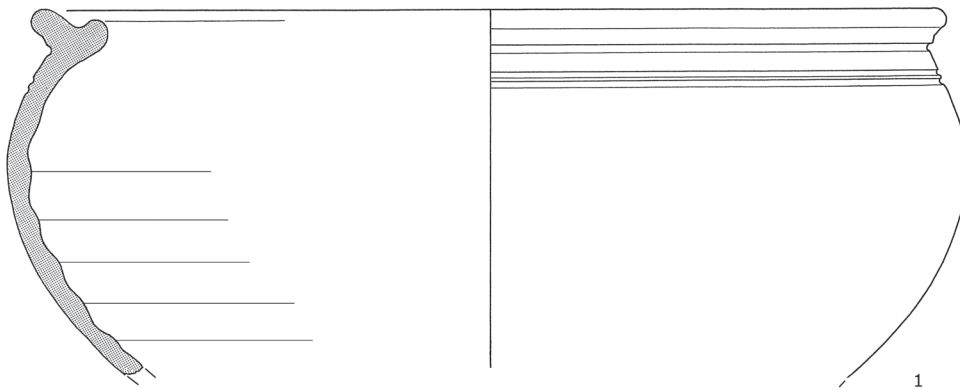

Grab 260



Nagel
Beschlag

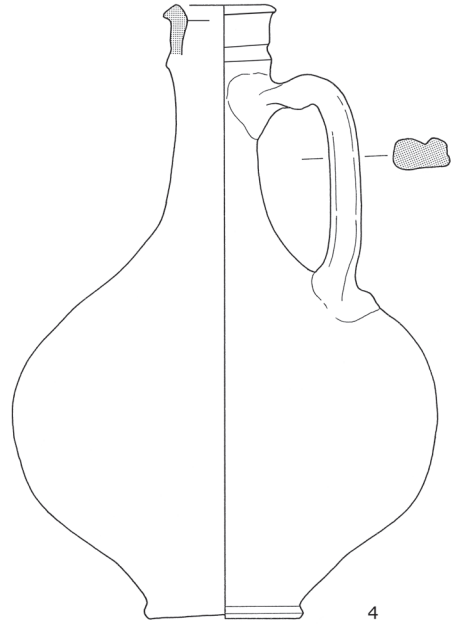
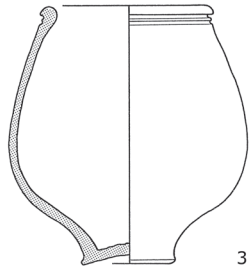

Grab 261



Nagel

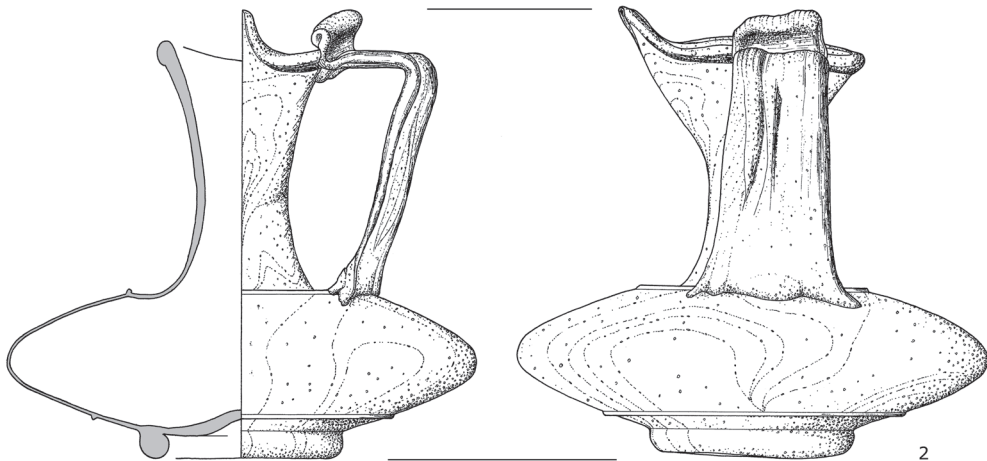
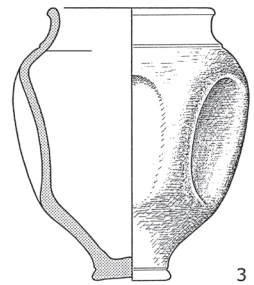
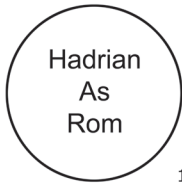

← Grab 261

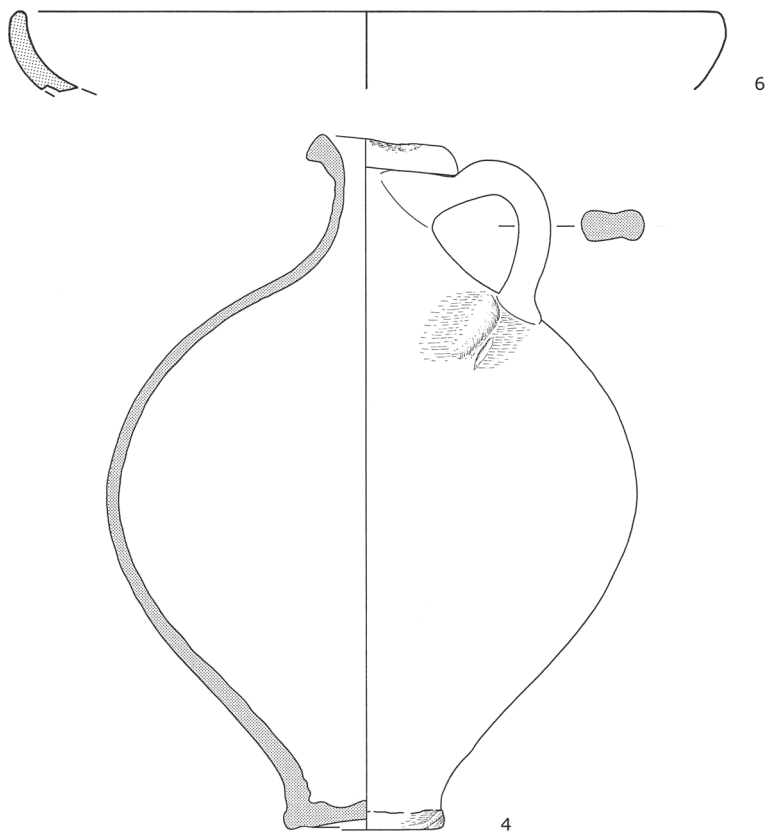

Fundstelle 262



Nagel
Sandstein

Grab 263 A



Grab 263 B



Nägel
Bronze

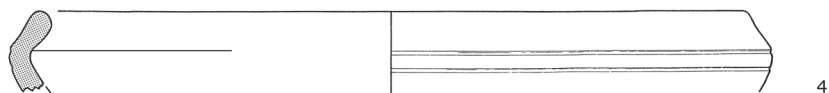
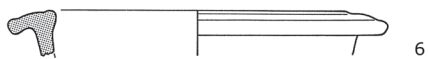
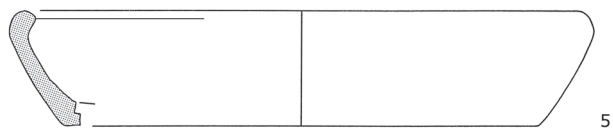
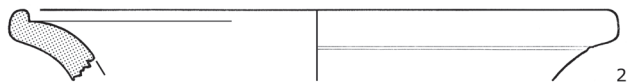
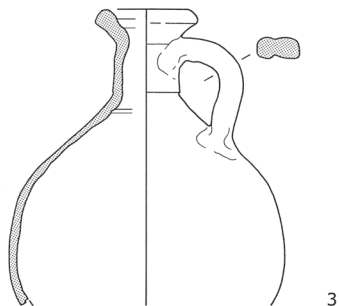

Grab 246



Nägel

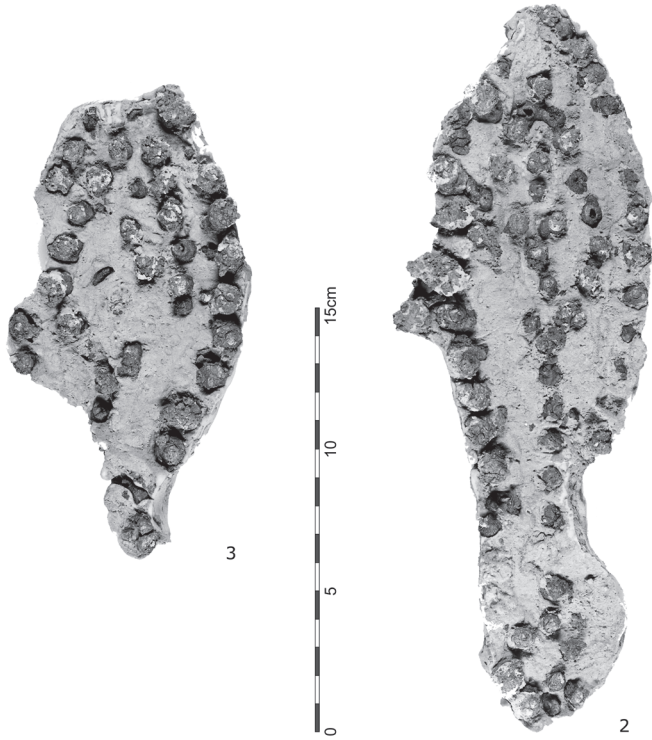

Fundstelle 265

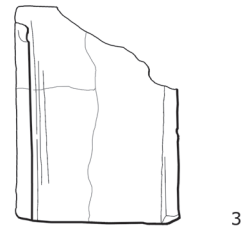
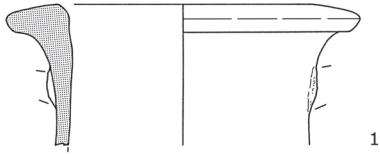

Grab 266



Schuhnagel
Keramik

Grab 267

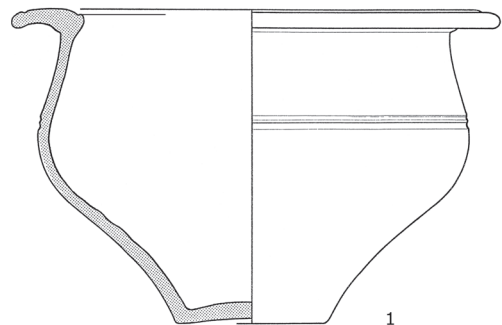
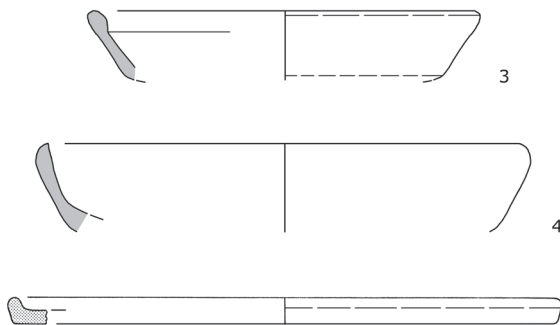

Grab 268



Glas
Nagel

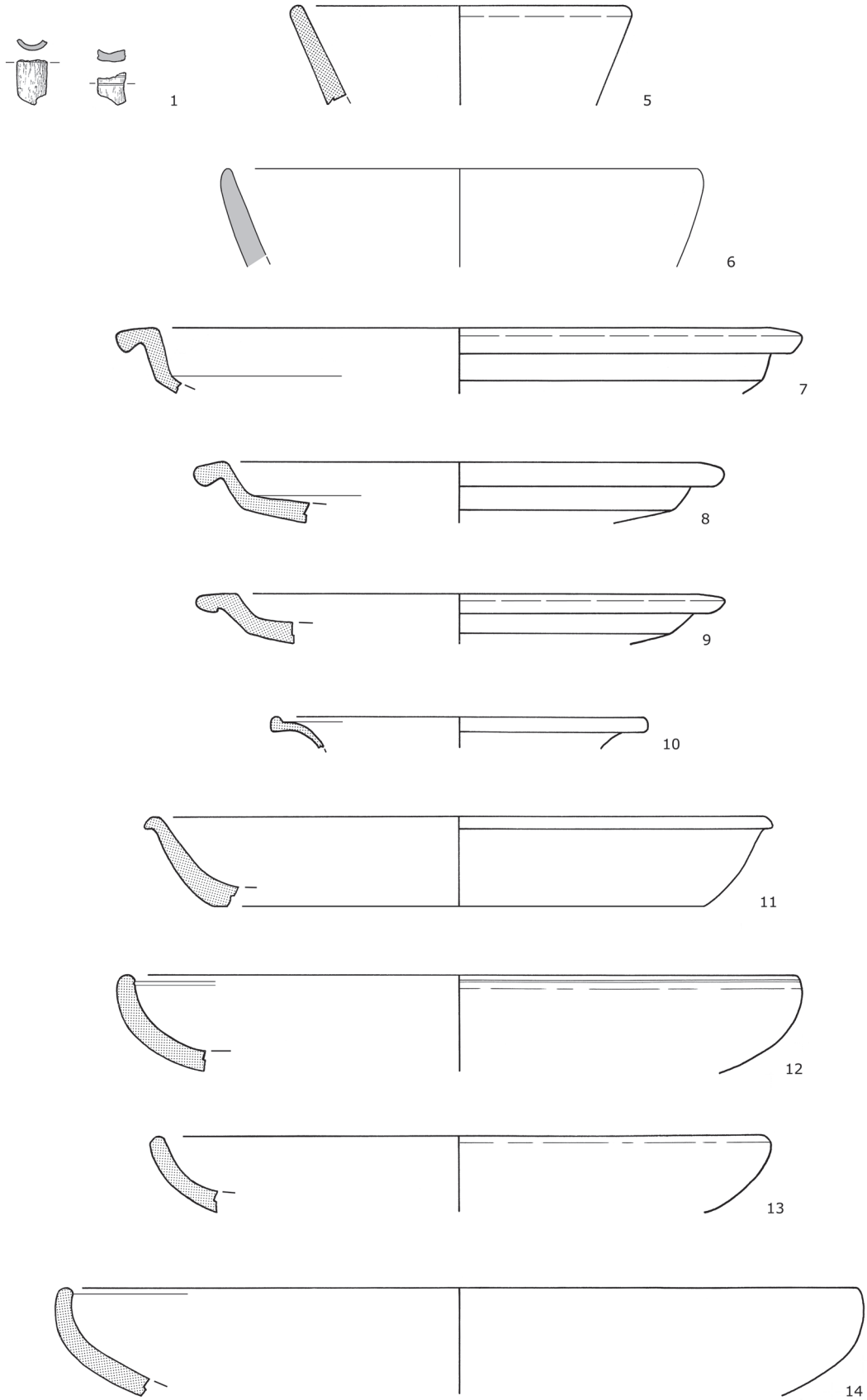

← Grab 268

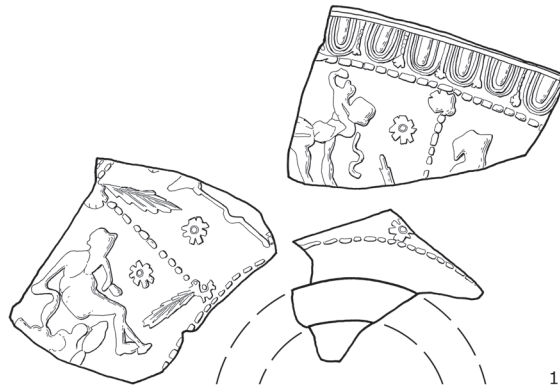

15

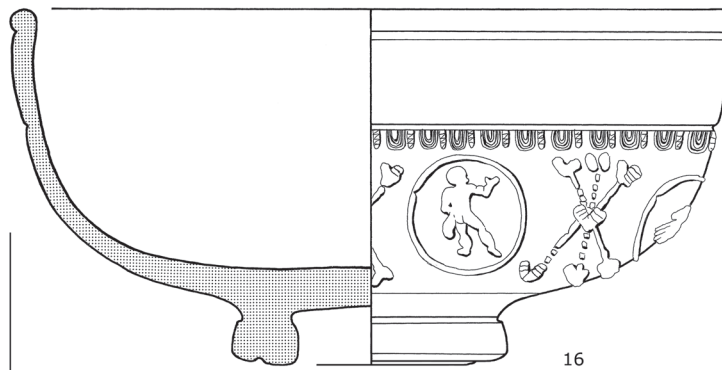

16

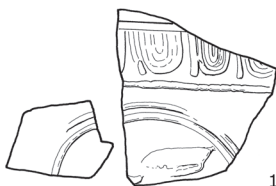
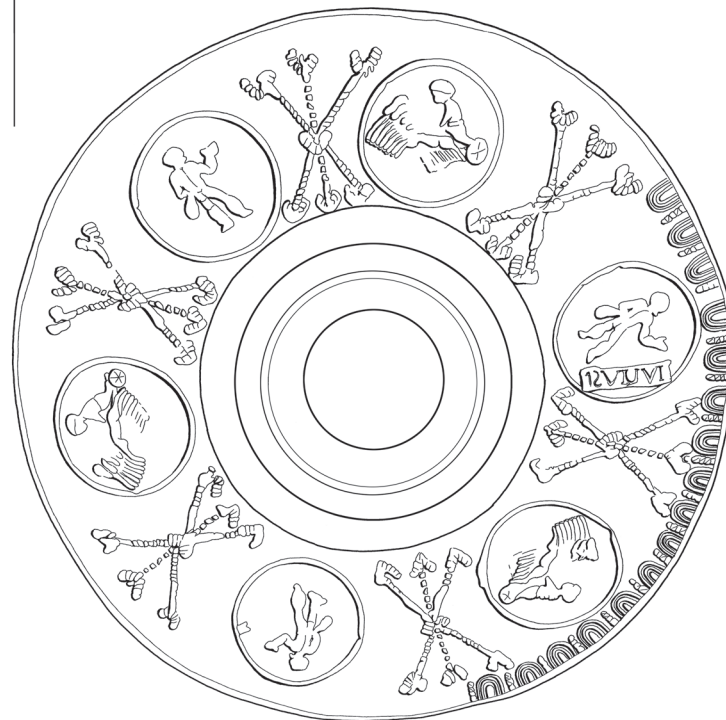

17



19

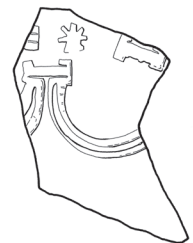

18

Grab 268

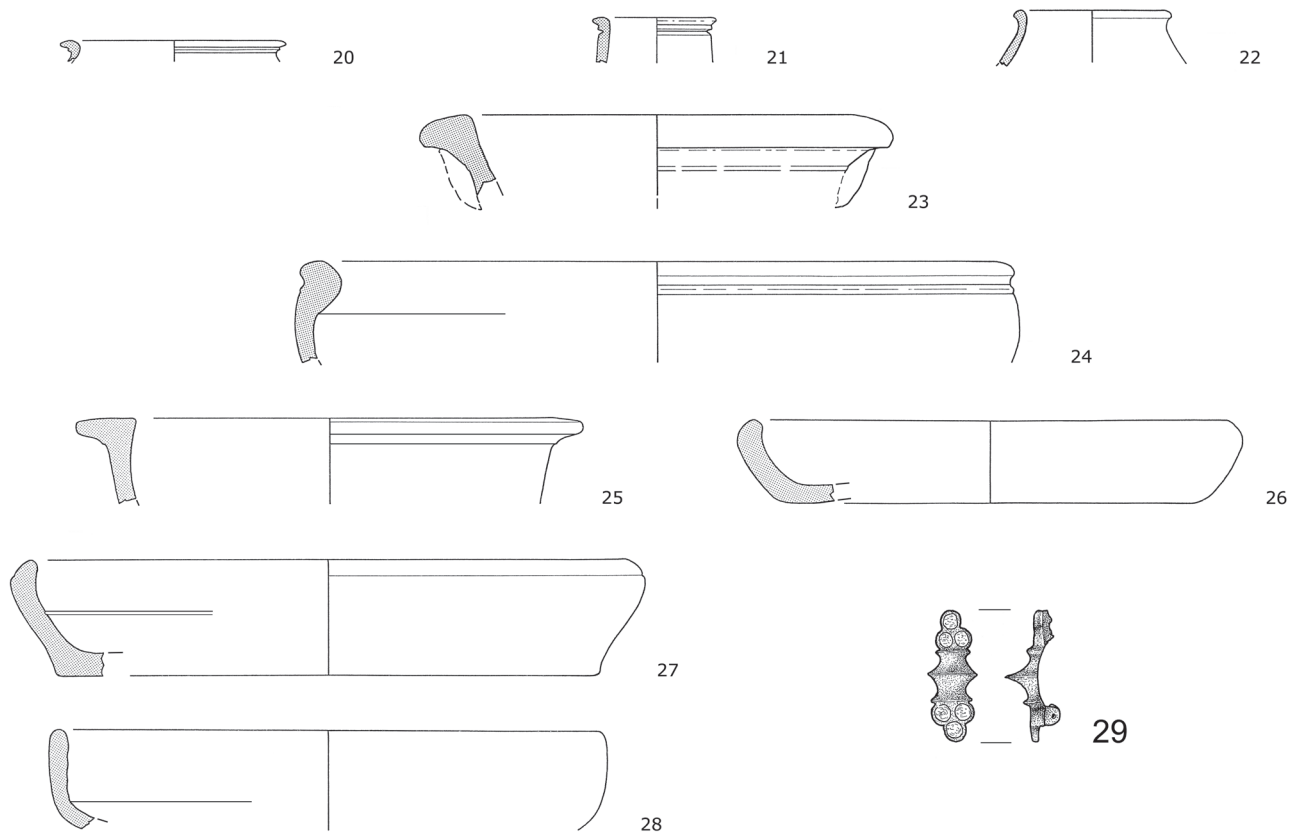

Grab 269



Keramik

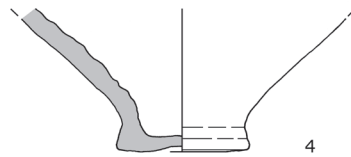

Grab 270

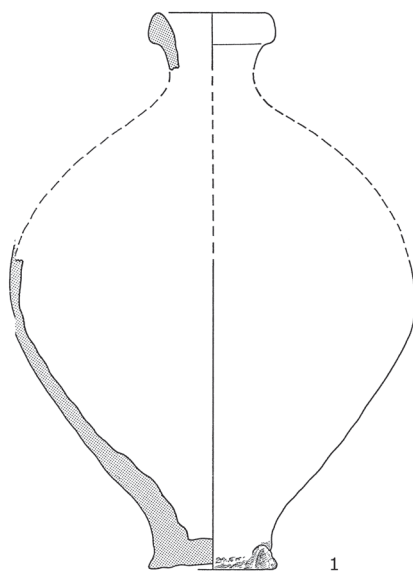

Grab 271

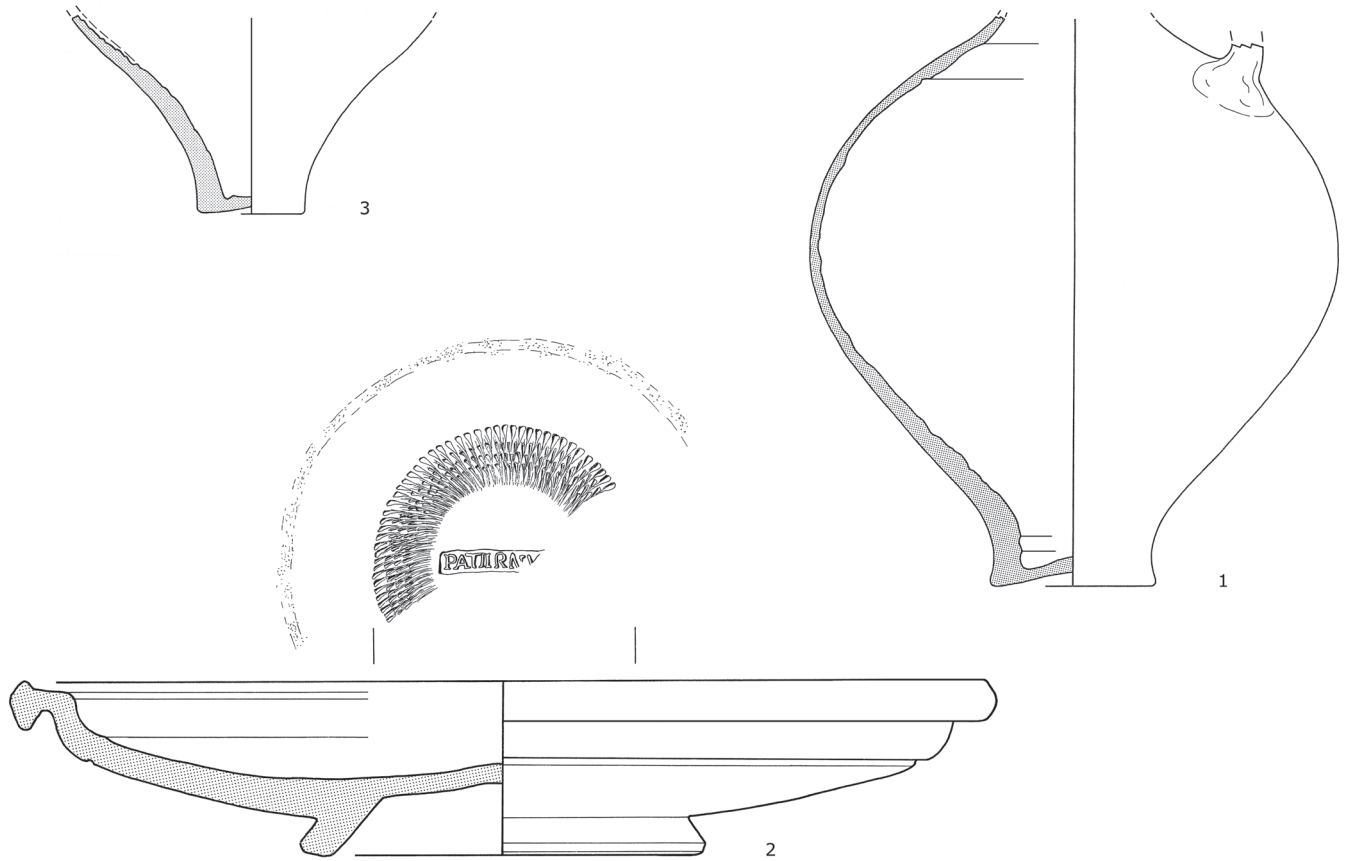

Grab 272



Nägel

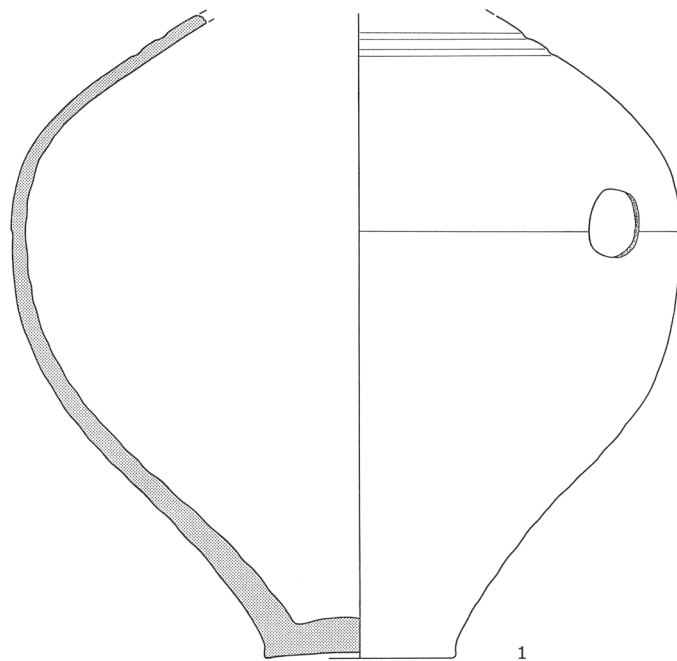

←
Grab 272

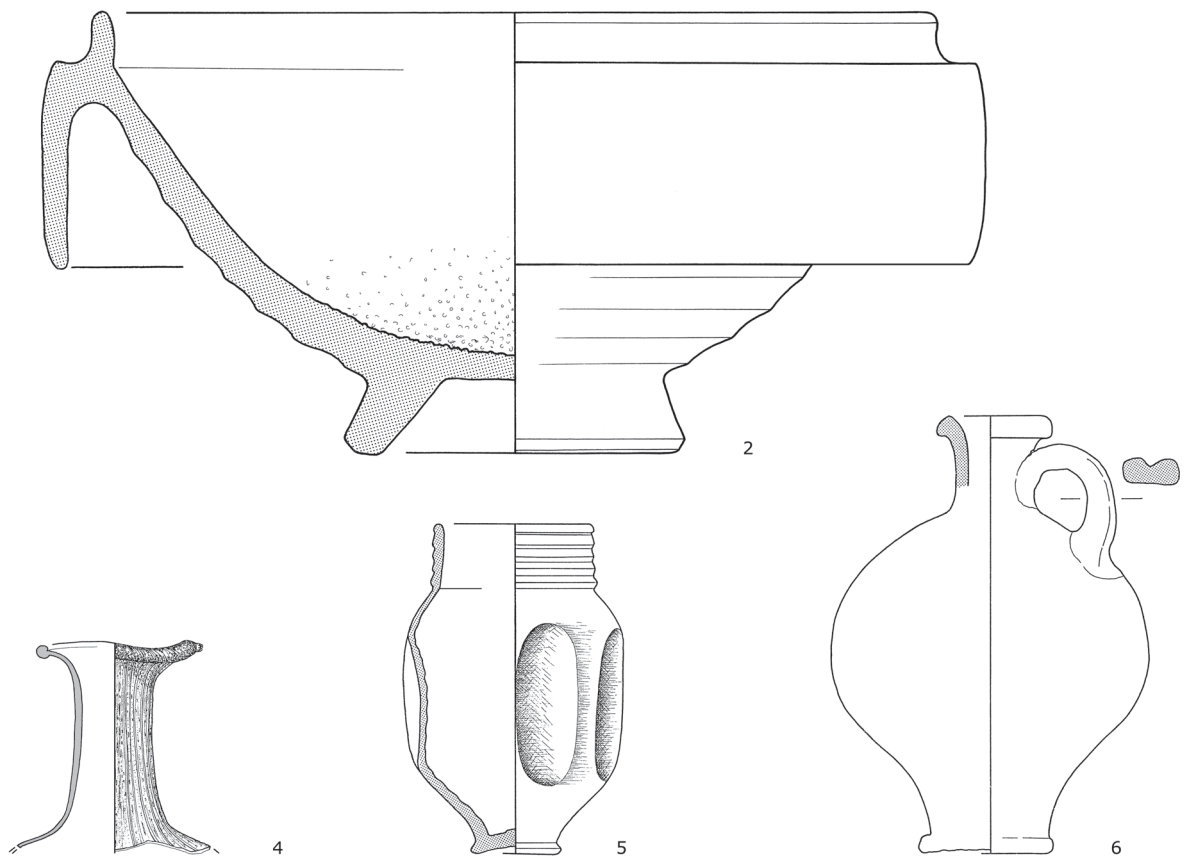

Grab 273



Nägel

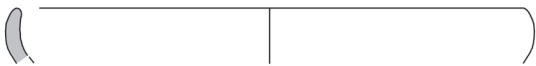

5

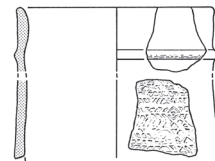

3

Grab 274



Nägel

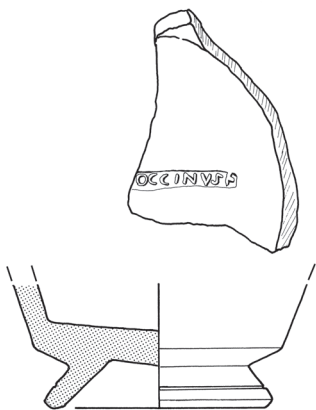

2



4

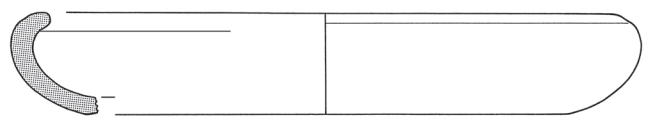

5

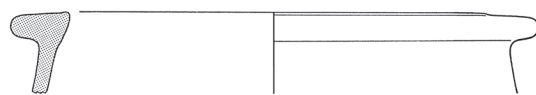

6

Grab 275

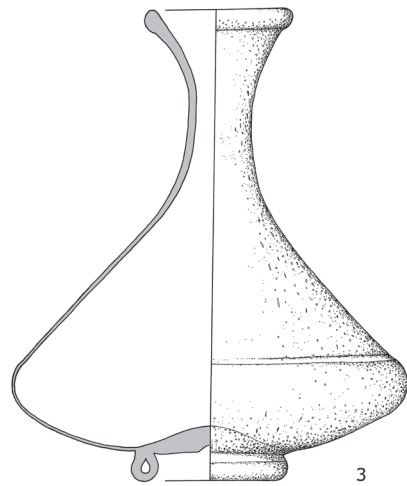
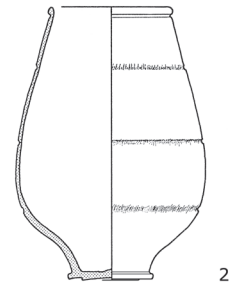
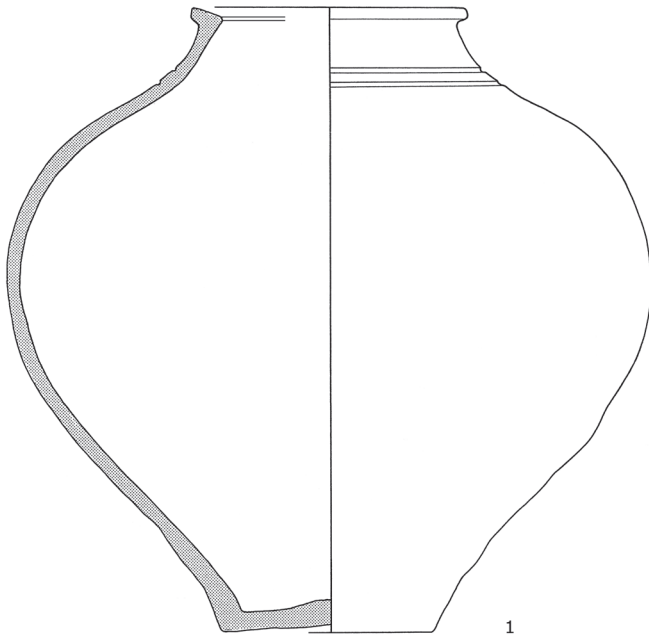

Grab 276



Schuhnägel
Nagel

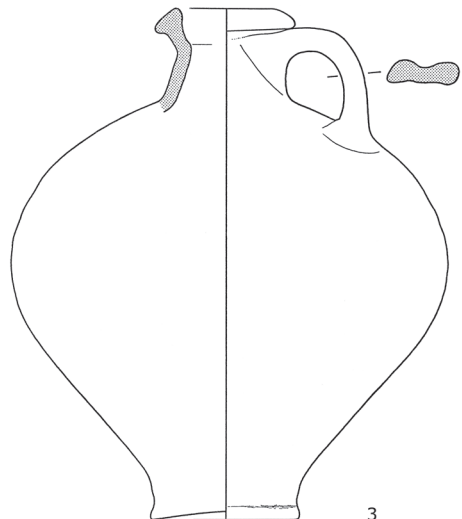
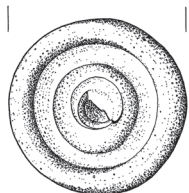
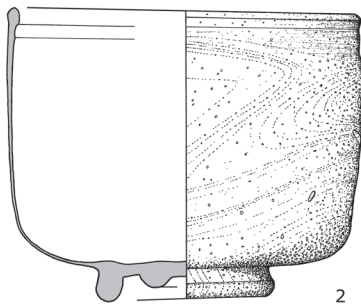
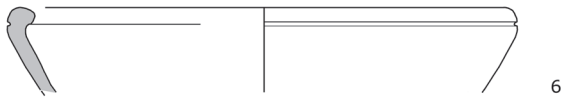

Grab 277

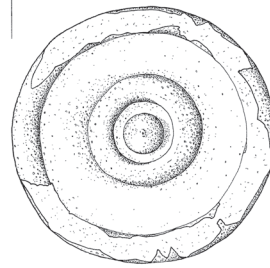
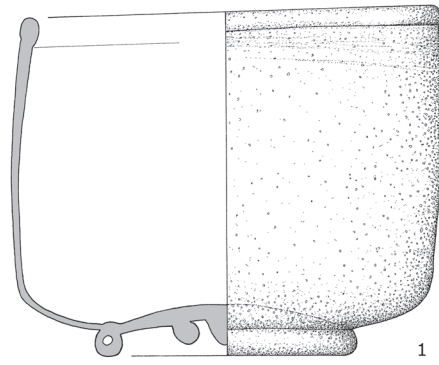
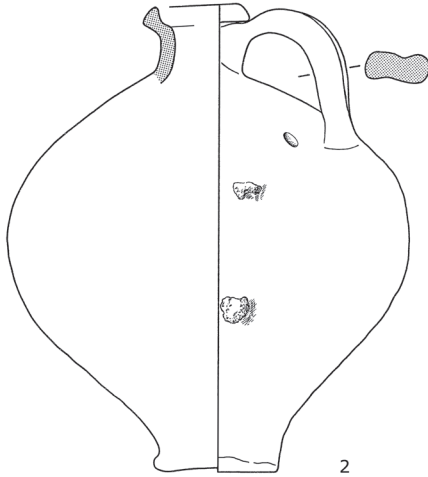

Grab 278



Nagel

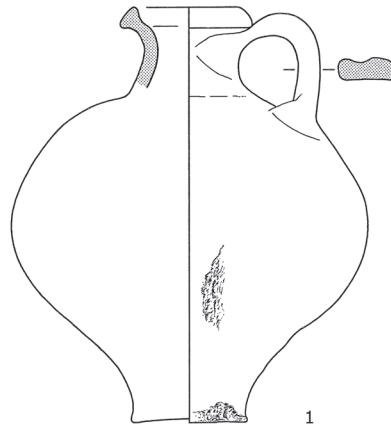

Grab 279



Schuhnagel

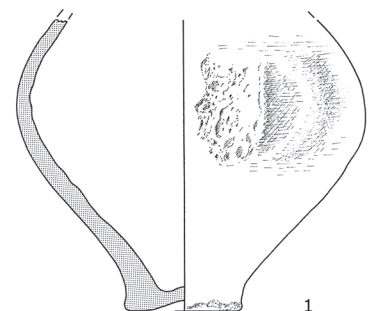
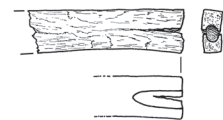
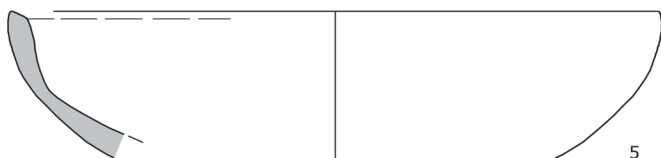
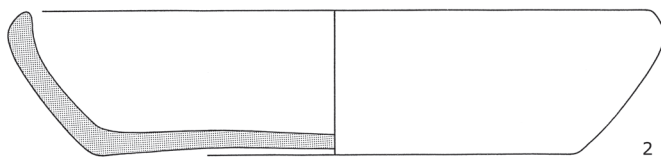

Grab 280



Nägel

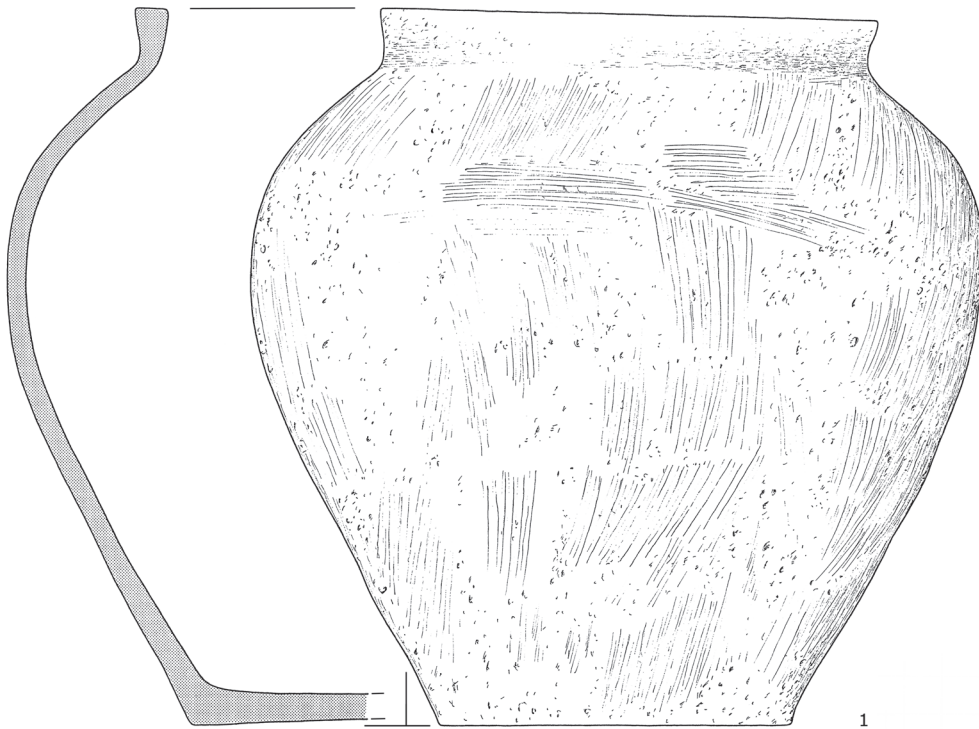
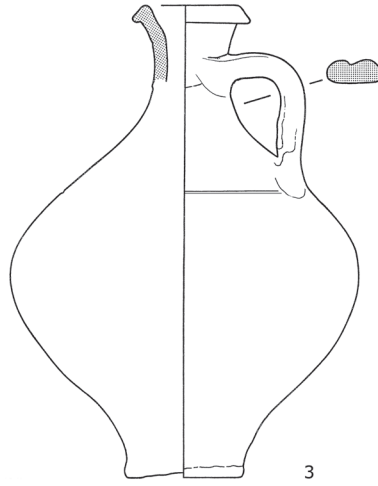

Grab 281



Nägel

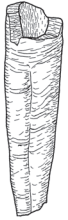

4

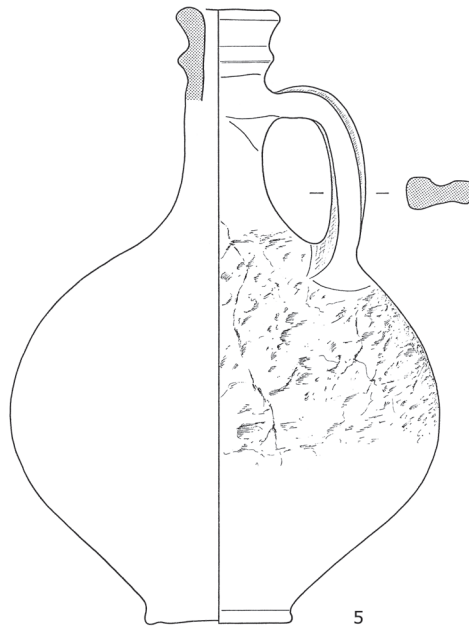

5

Grab 282



Grab 283



Glas
Nägel
Keramik

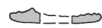

3

Grab 284



Glas
Nägel

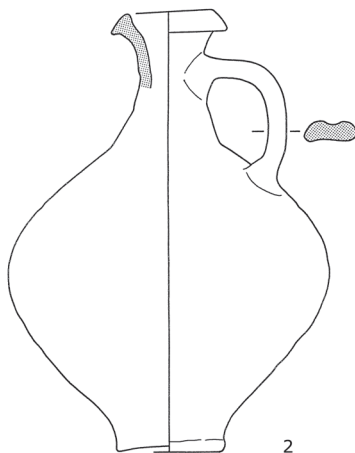

2

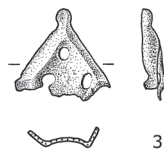

3

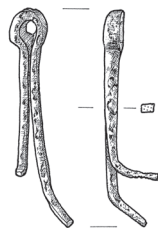

10

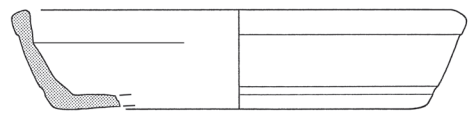

7



8

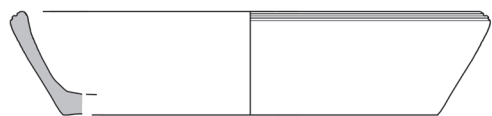

9

← Grab 284

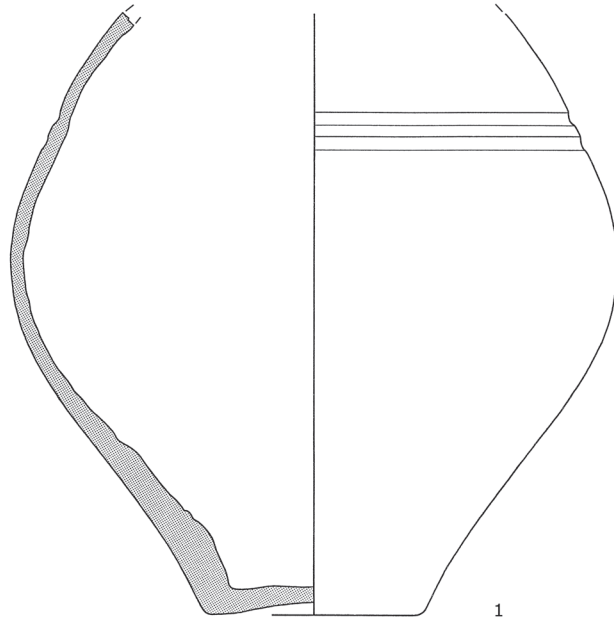

Grab 285

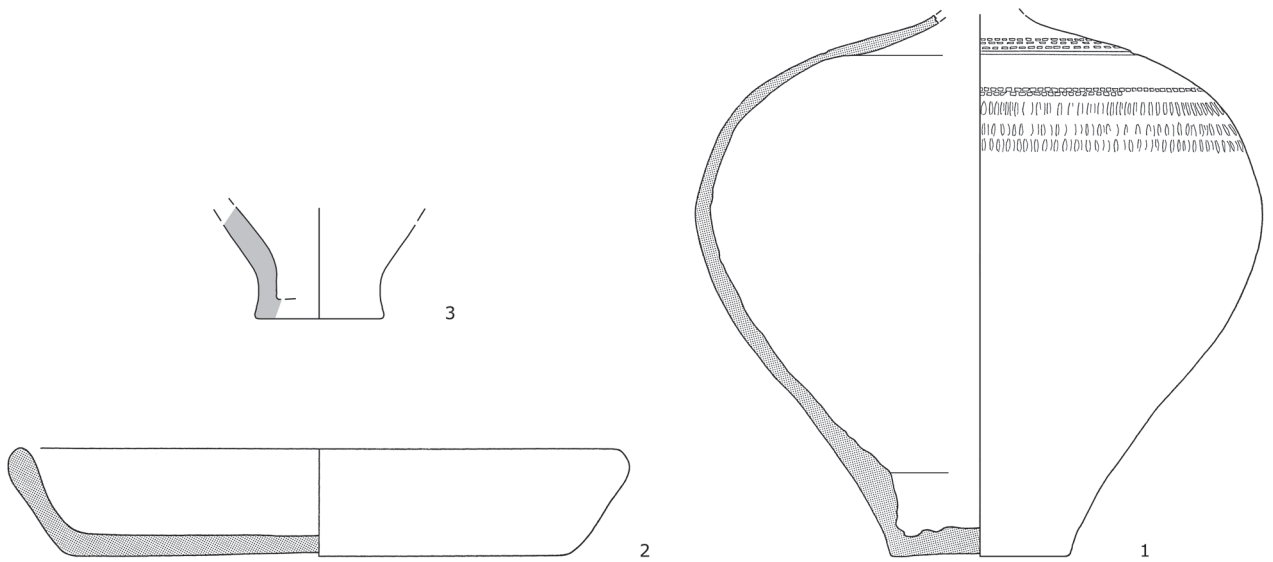

→ Grab 286

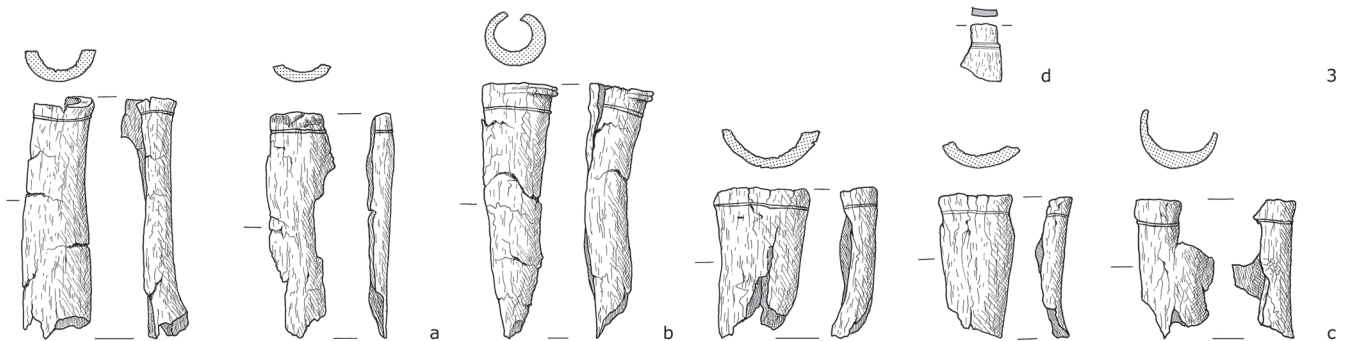

← Grab 286

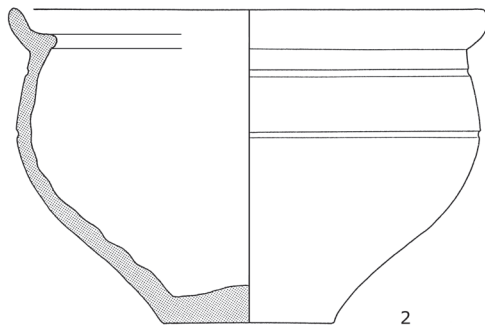
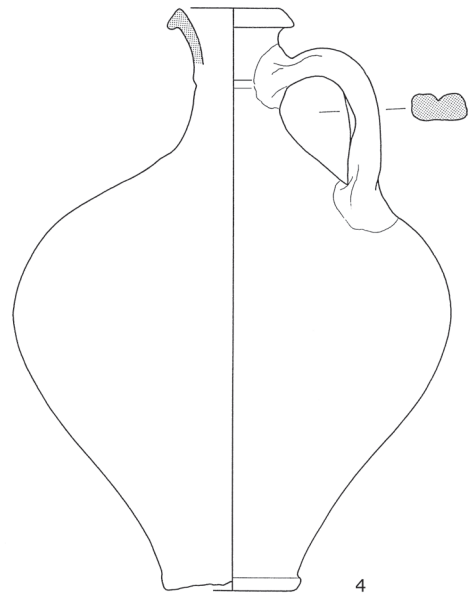
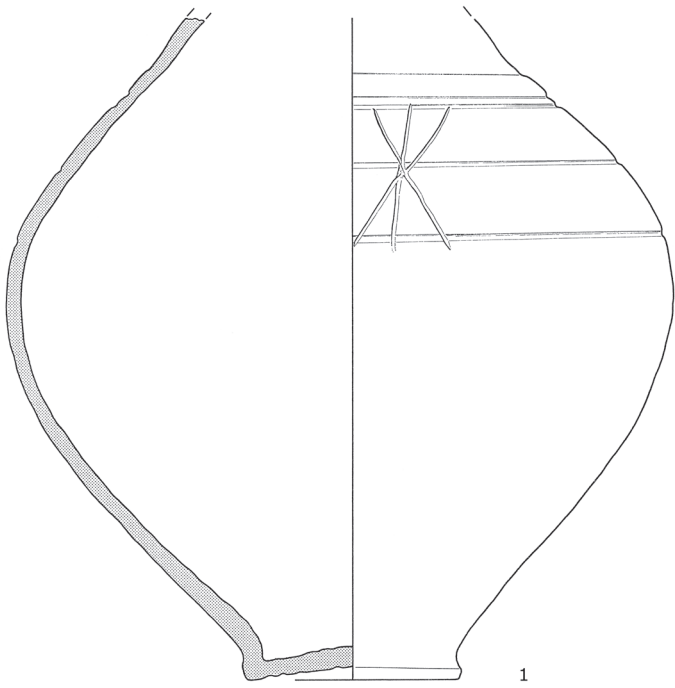

→ Grab 287



Keramik

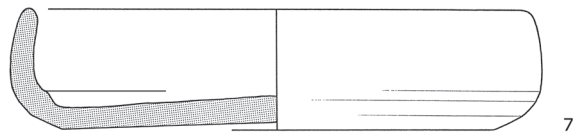
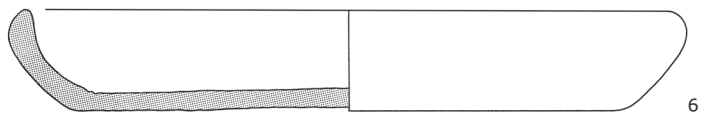
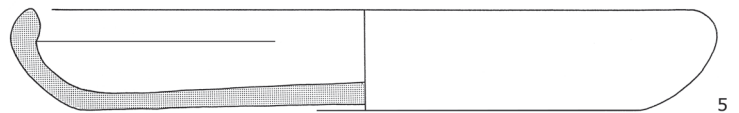
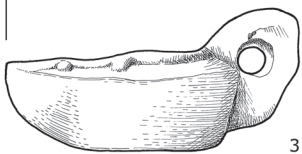
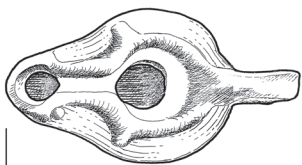

← Grab 287

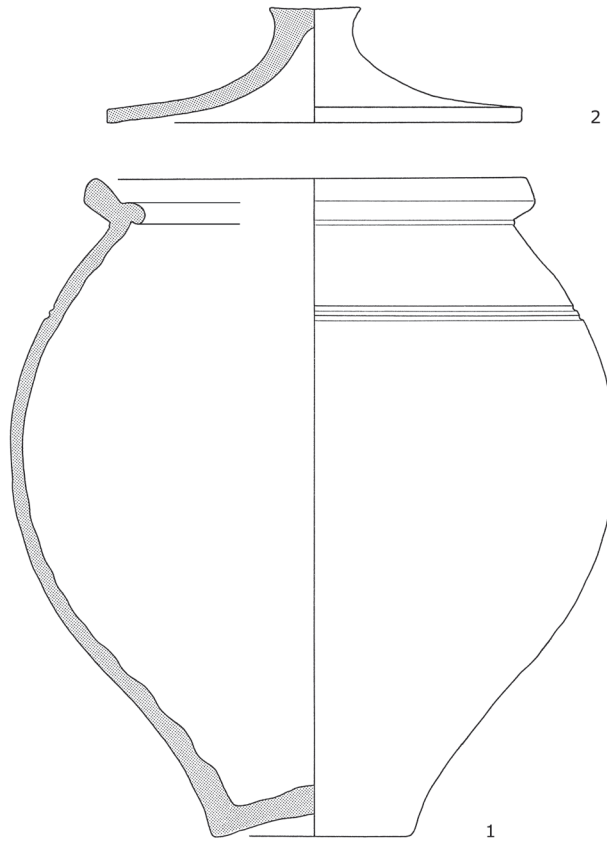

→ Grab 288



Nägel

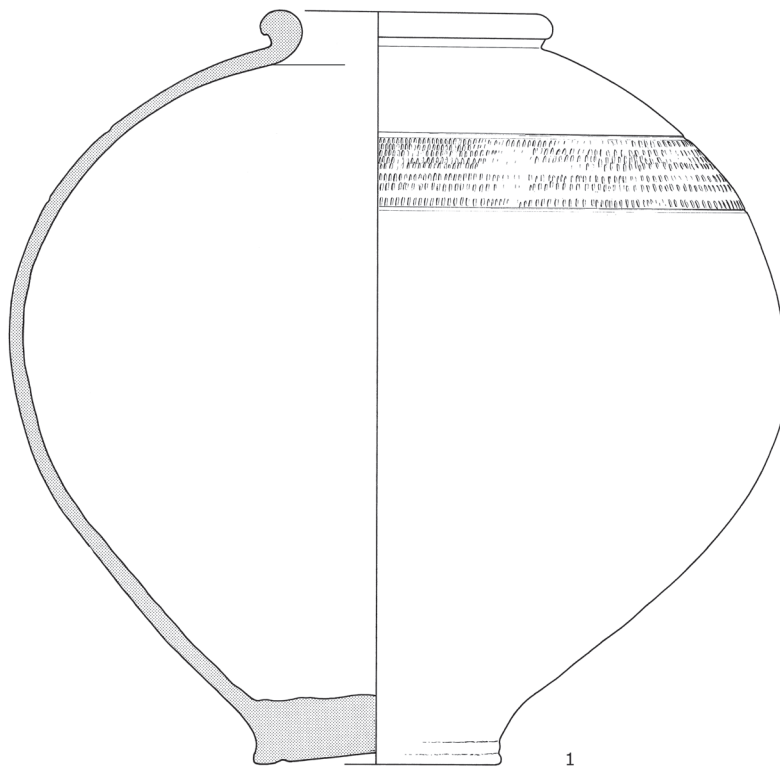

← Grab 288

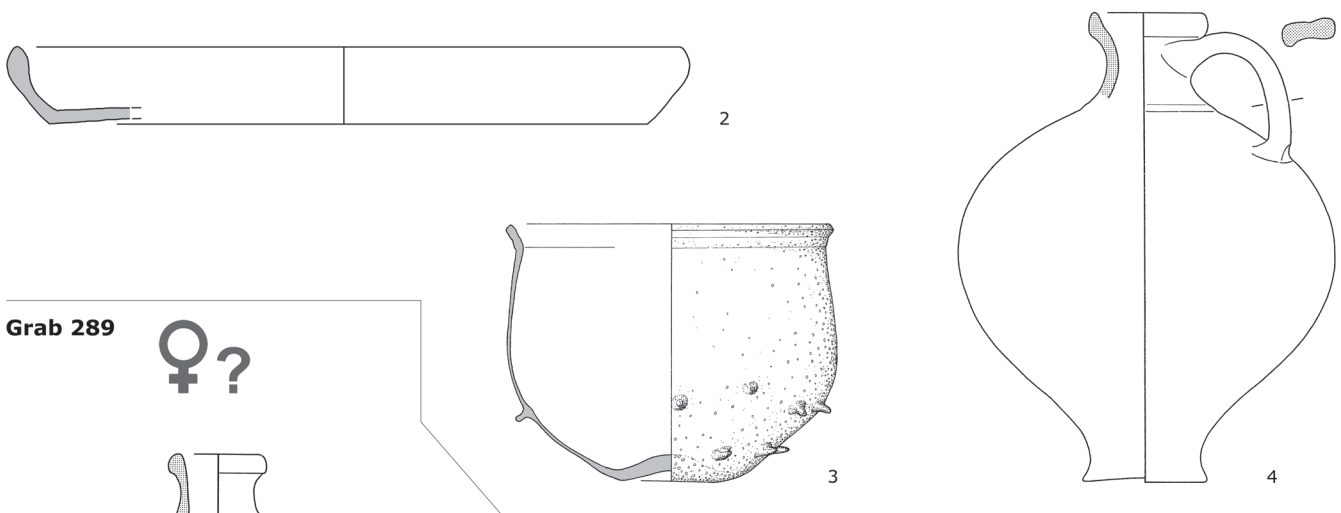

Grab 289

♀ ?

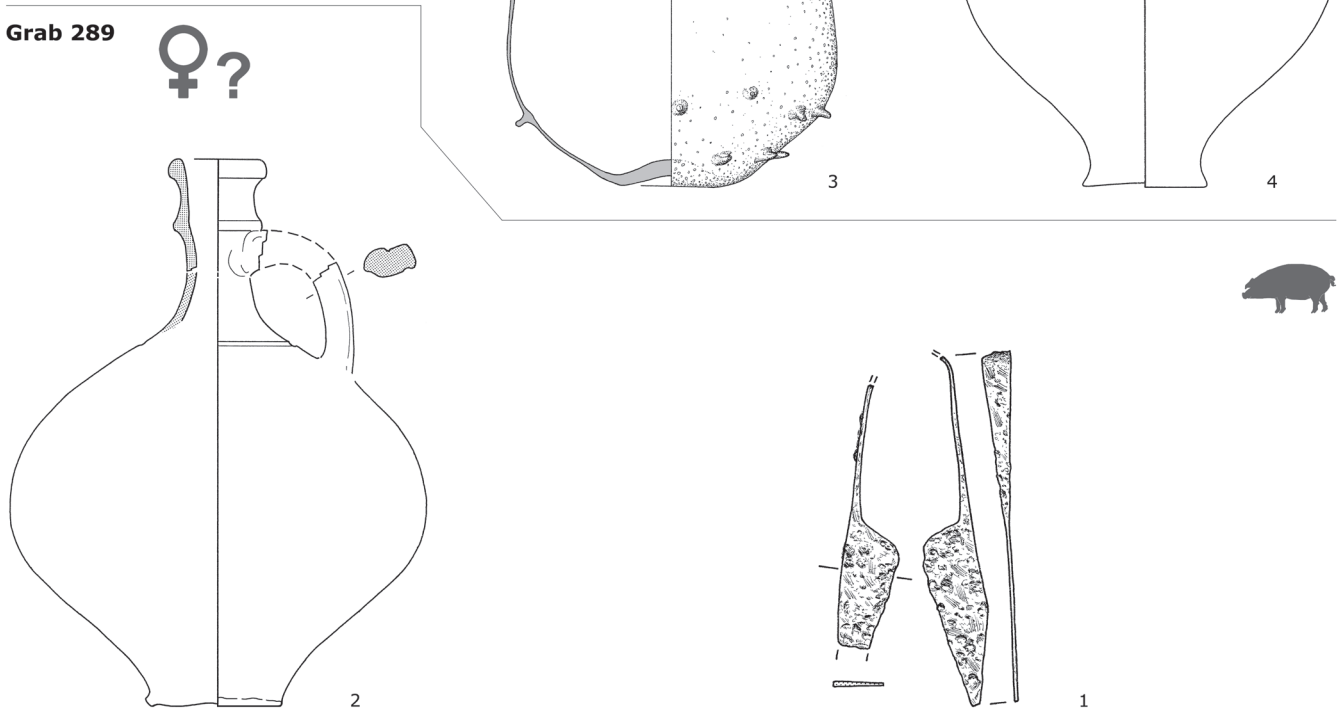

Grab 290

♀



Nägel

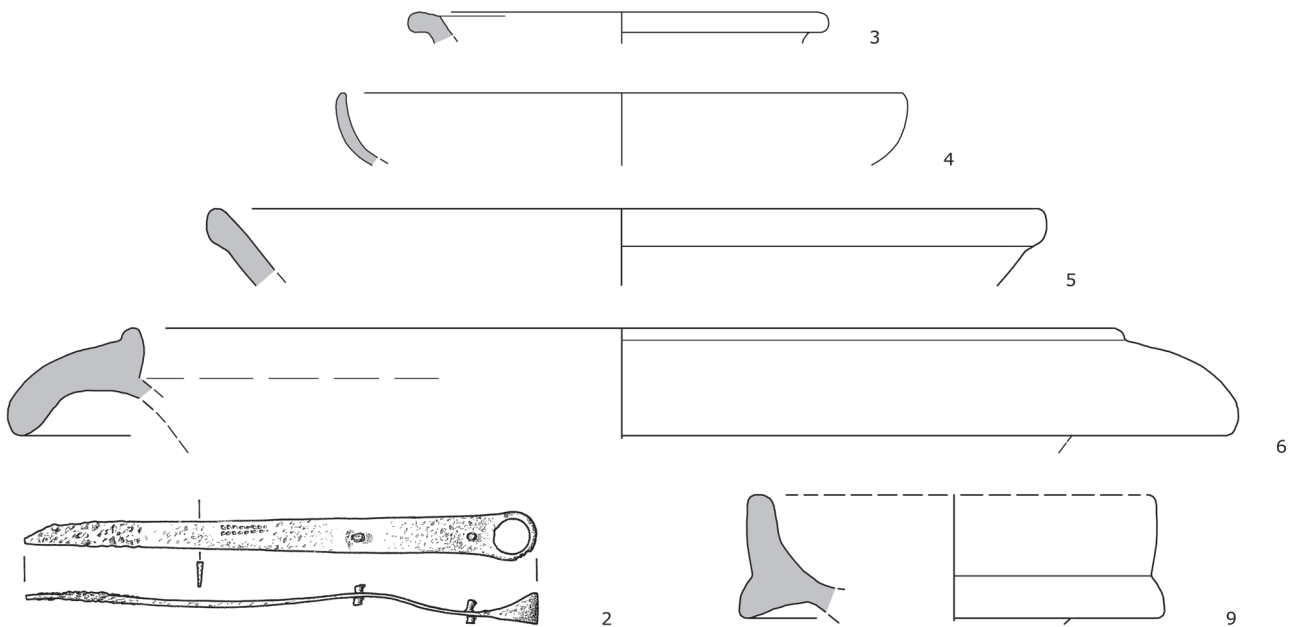

Grab 291

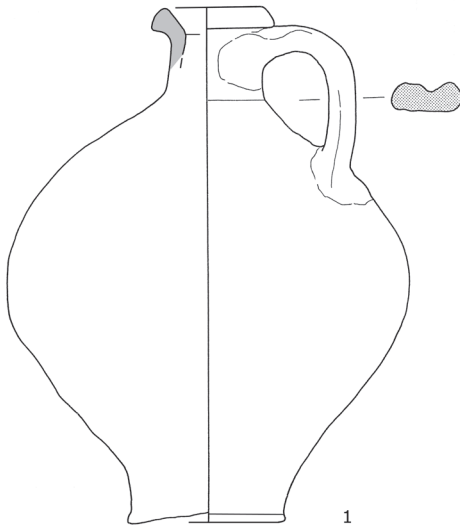

1



4

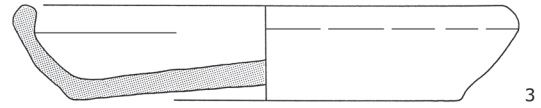

3

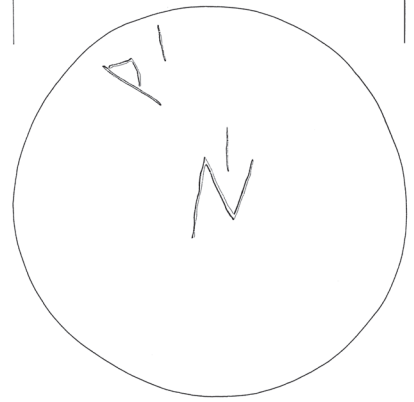

Grab 292



Nägel



Grab 293



Schuhnägel
Nägel
Glas

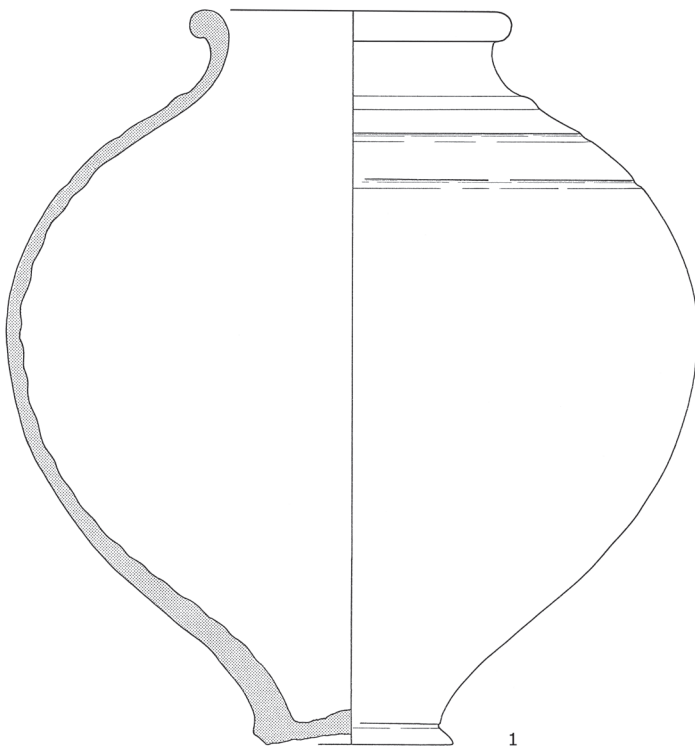

1

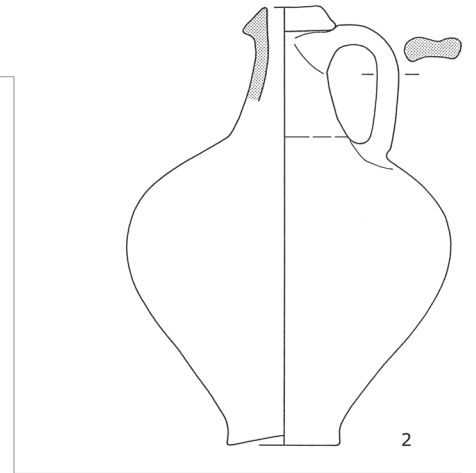

2

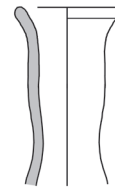

5

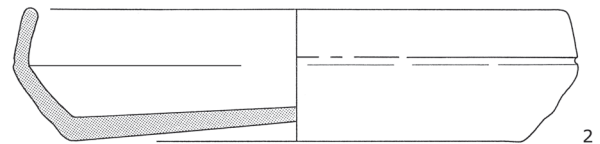

2

Grab 294

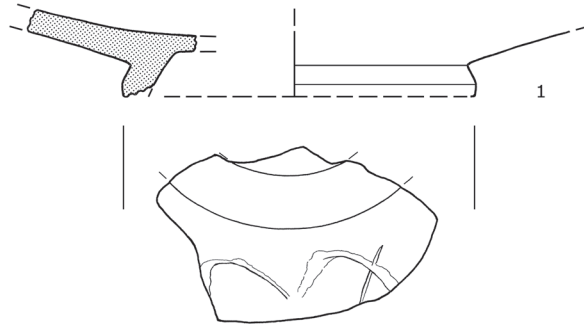

Fundstelle 295



Sandstein

Fundstelle 296



Nagel



Grab 297



Grab 298



Keramik

Grab 299



Nagel

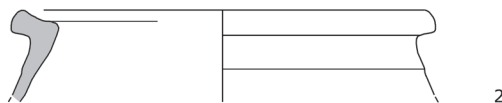

Grab 300



Grab 301

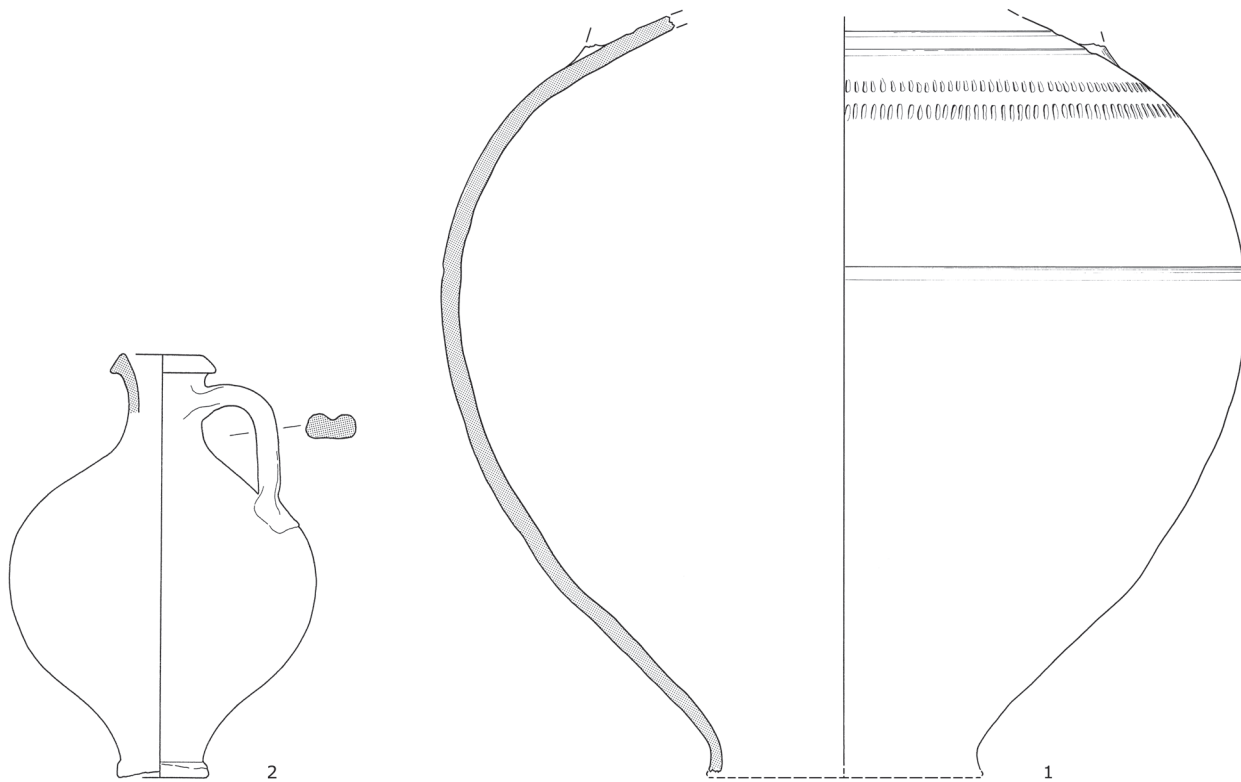

Grab 302



Glas

Fundstelle 303



Nägel



2



5

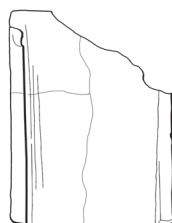

7

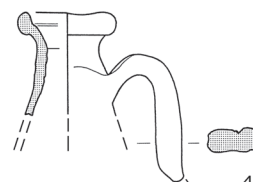

4

Grab 304



Nägel
Schuhnägel



Hadrian
As/Dp.
Rom

1

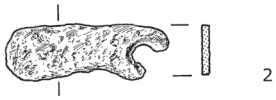

2

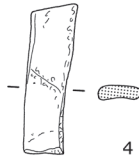

4

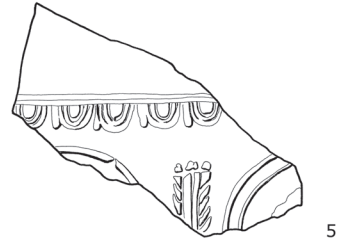

5

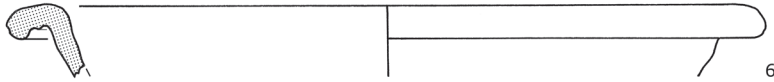

6

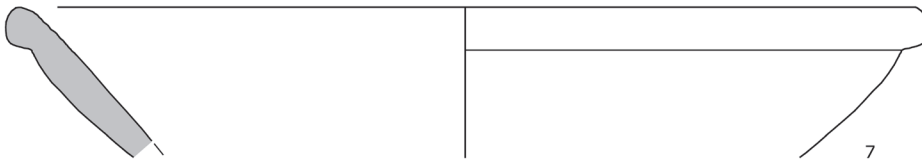

7

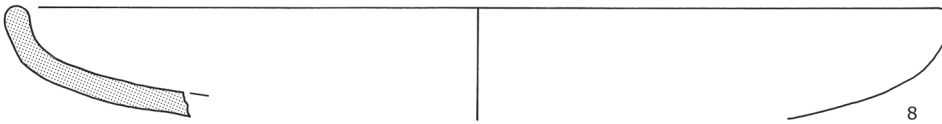

8

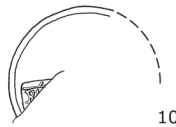

10

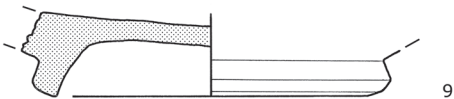

9

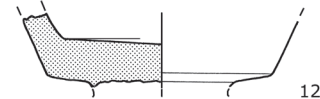

12

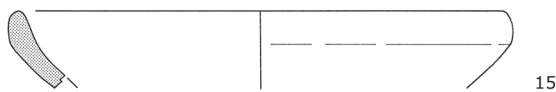

15

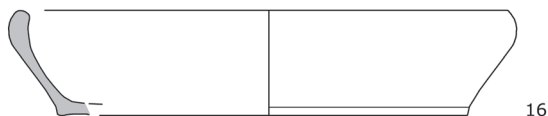

16

Grab 305



Nägel

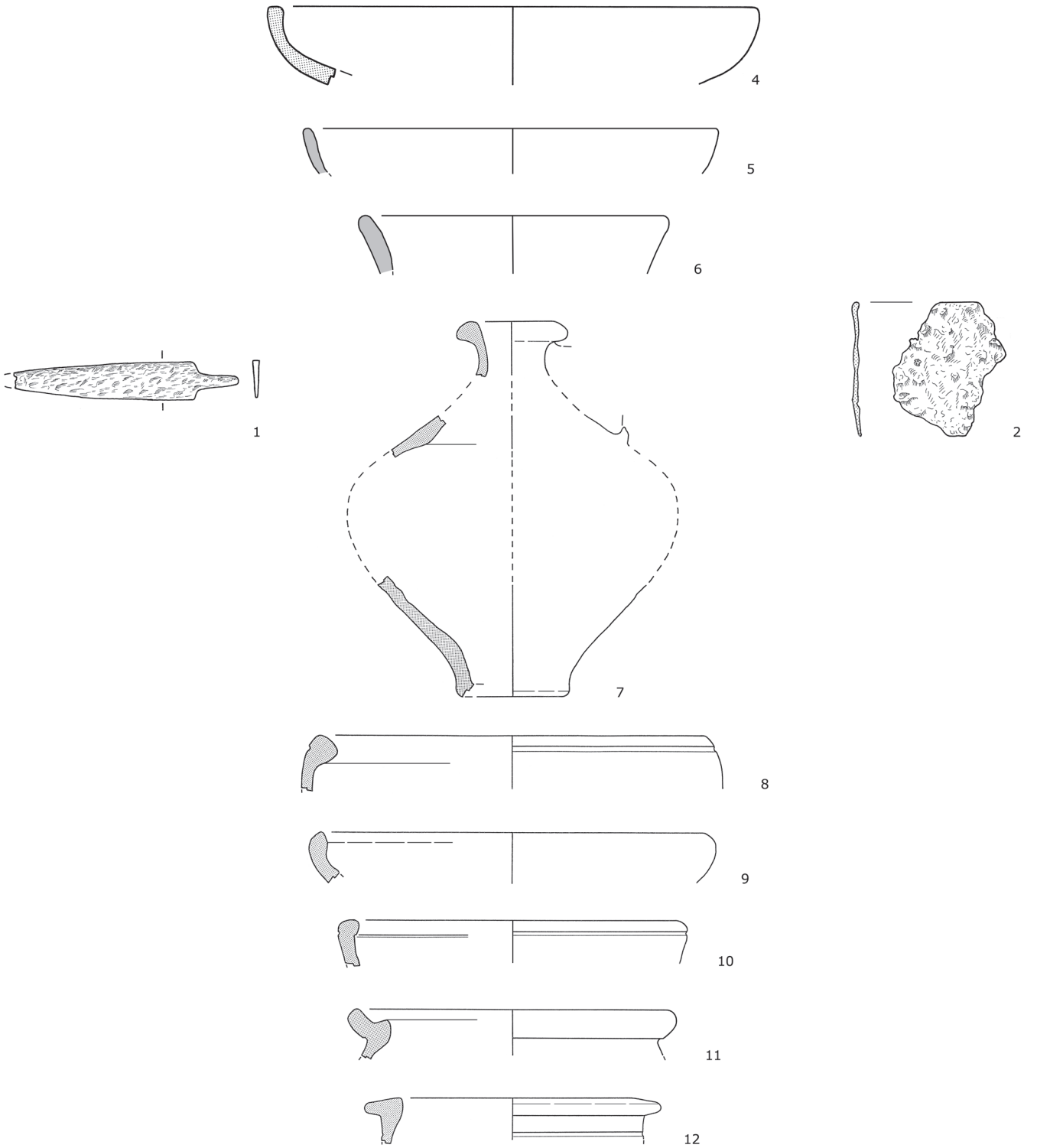

Grab 306



Grab 307

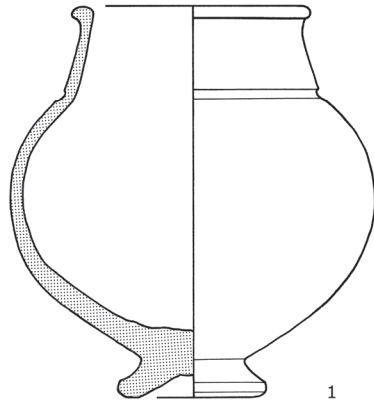

1

Grab 308



Nagel

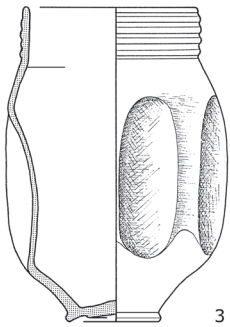

3

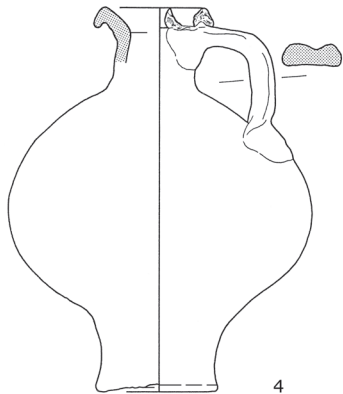

4

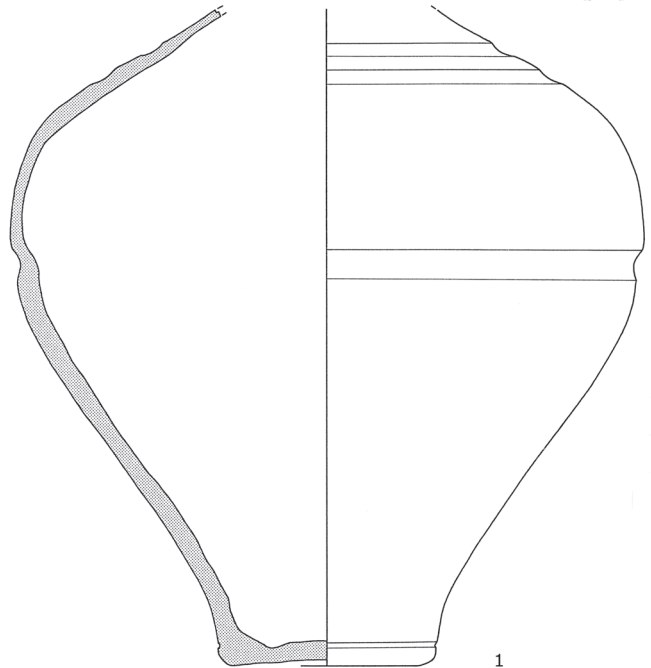

1

Fundstelle 308/309
Zwischenbereich



Nagel

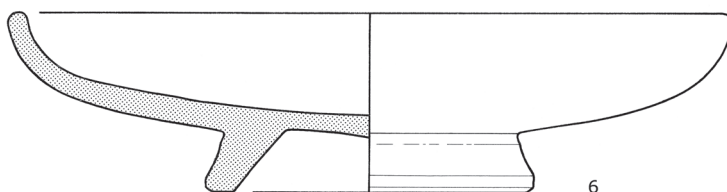

6

Fundstelle 308/309
Zwischenbereich

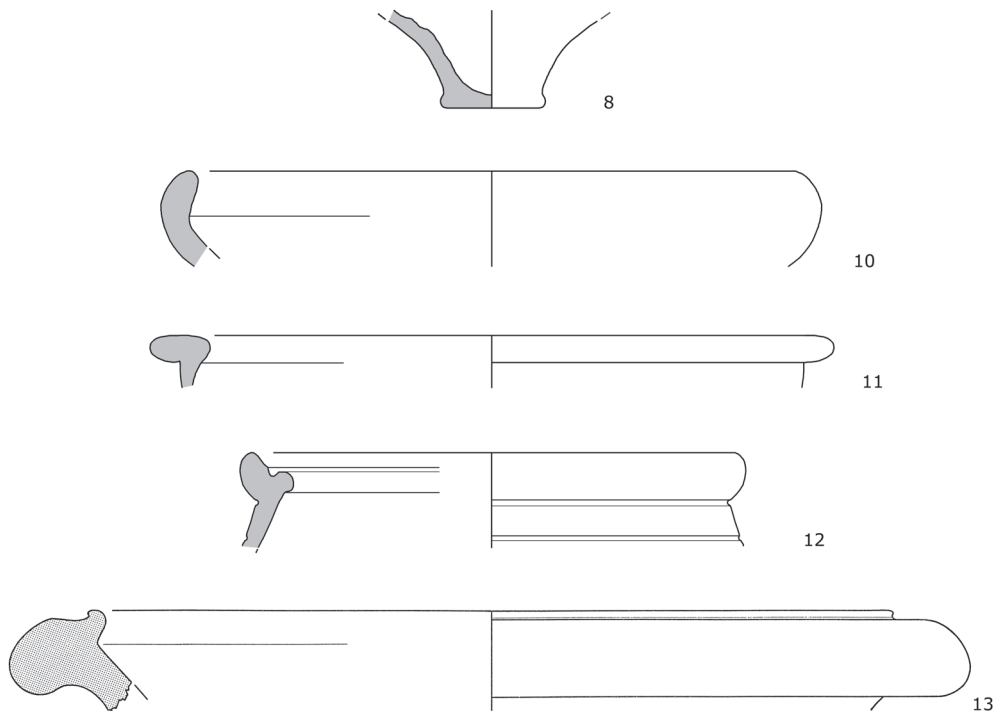

Grab 309

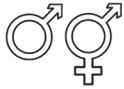

Schuhnagel
Stilus
Keramik

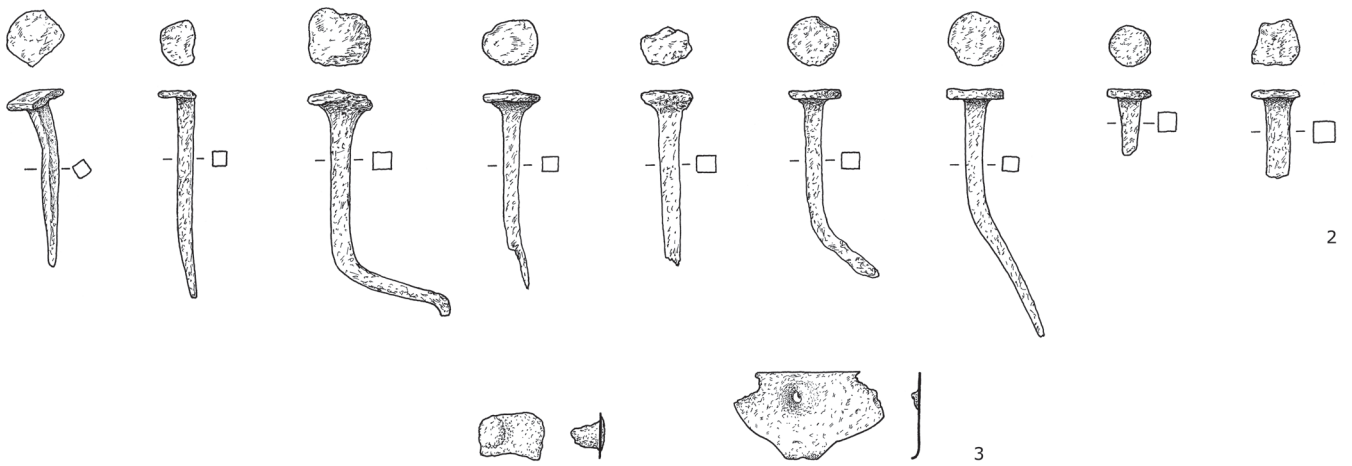

Grab 310

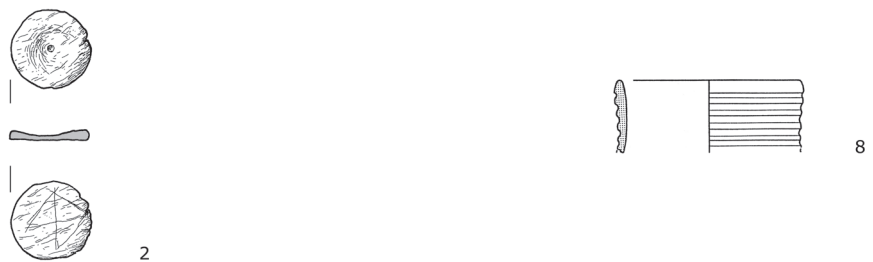

← Grab 310

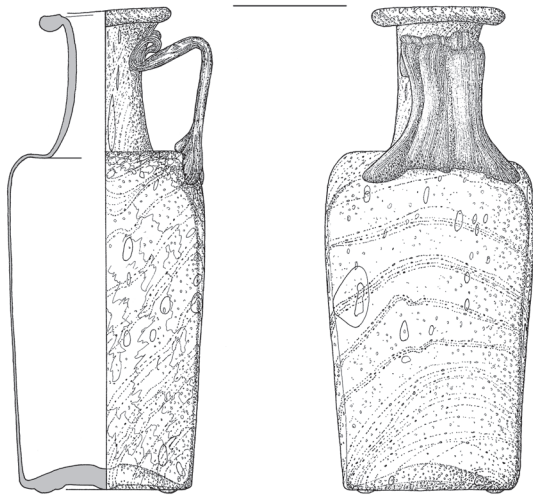

1

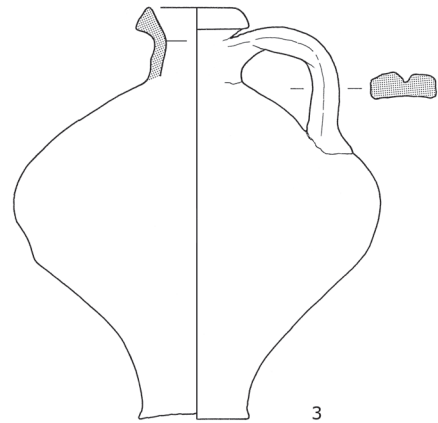
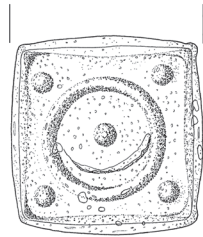

3

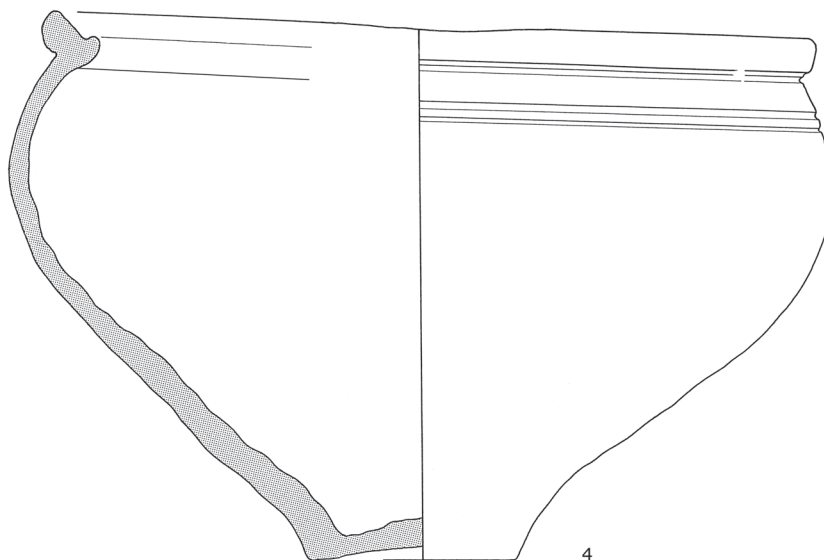

4

Grab 311



Nagel

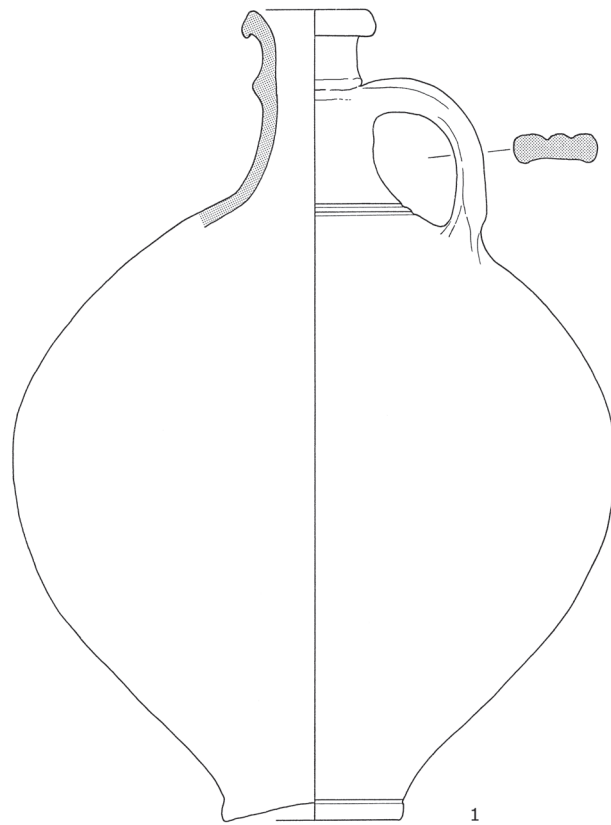

Grab 312



Nägel
Glas

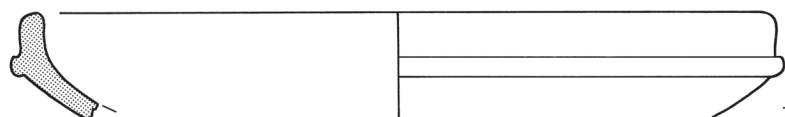
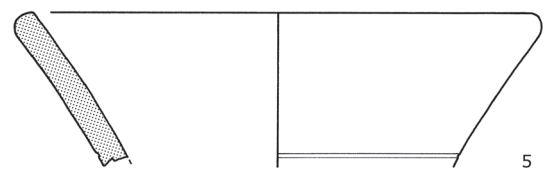
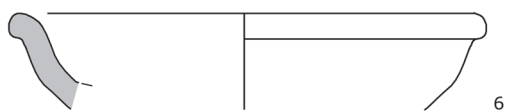
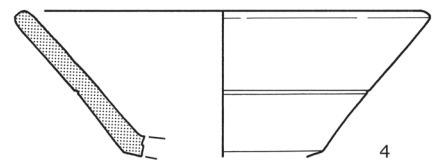
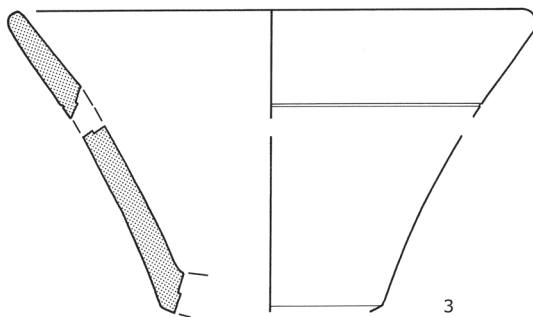

← Grab 312

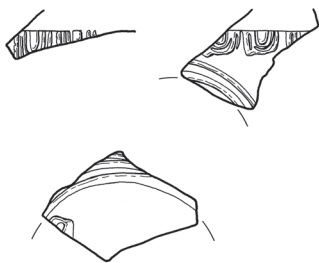
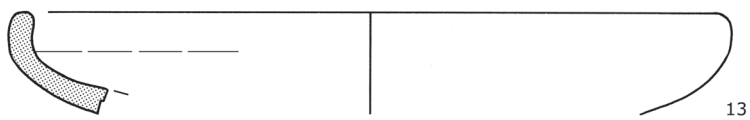
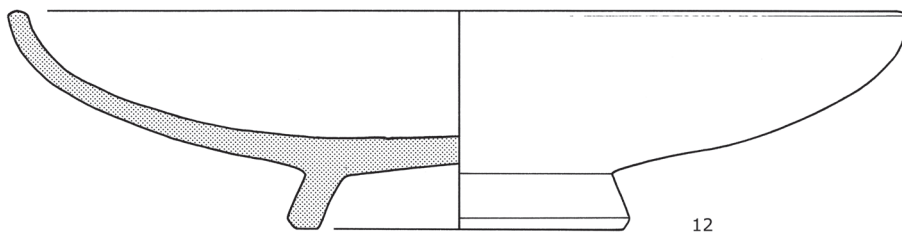
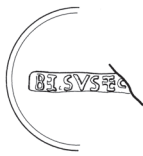
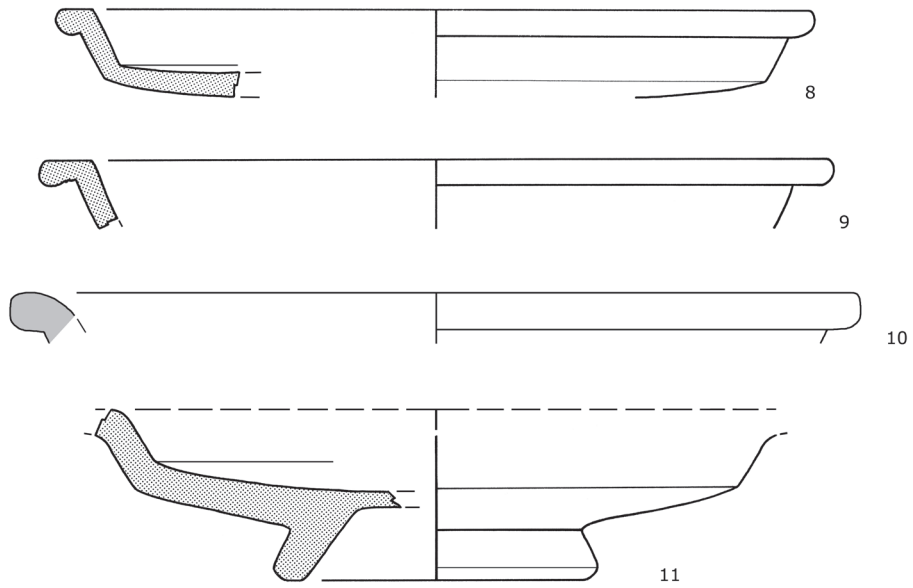

15



16

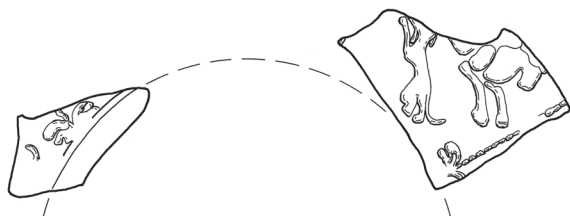

17

Grab 312

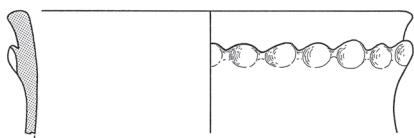
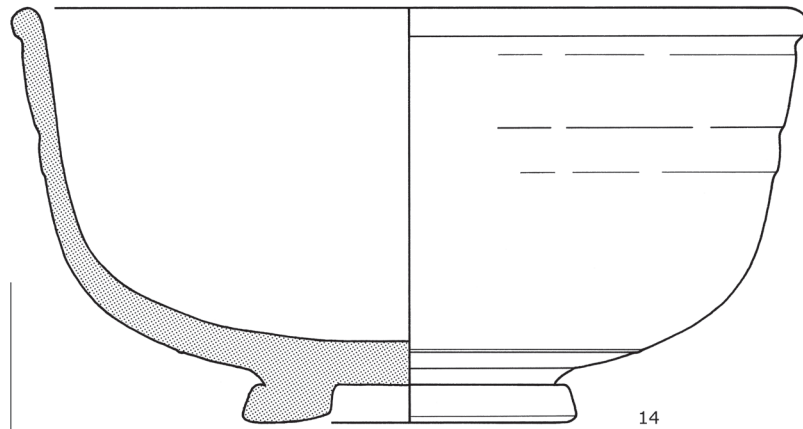

18

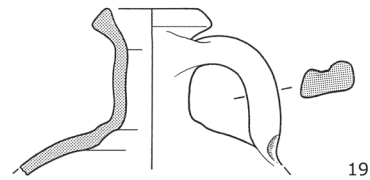

19

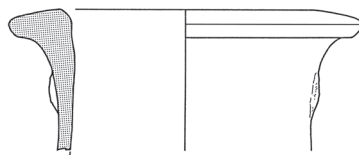

20

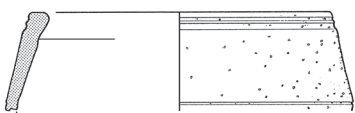

21

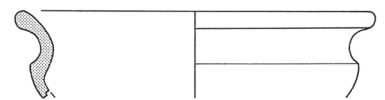

22

←←←←
Grab 312

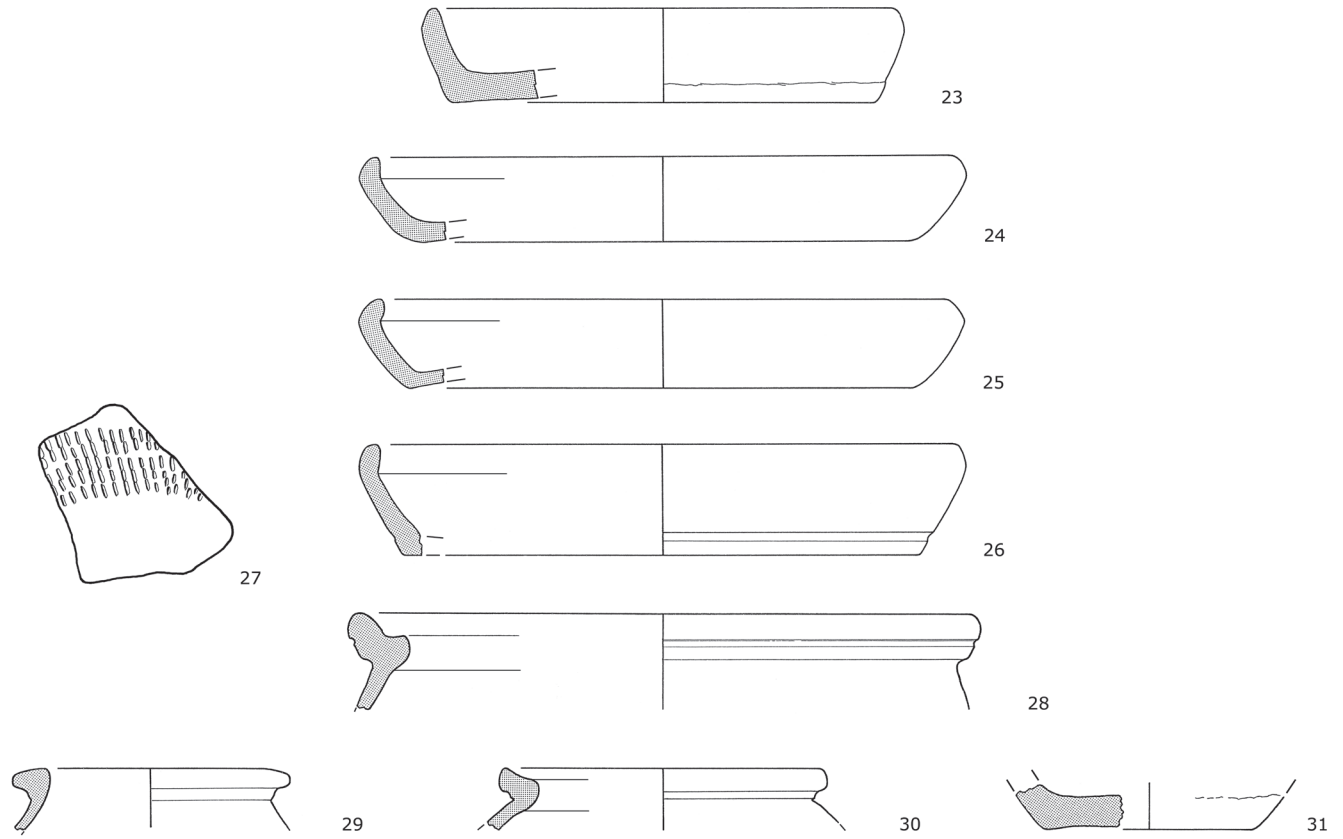

**Fundstelle 312/313
Zwischenbereich**



Nägel

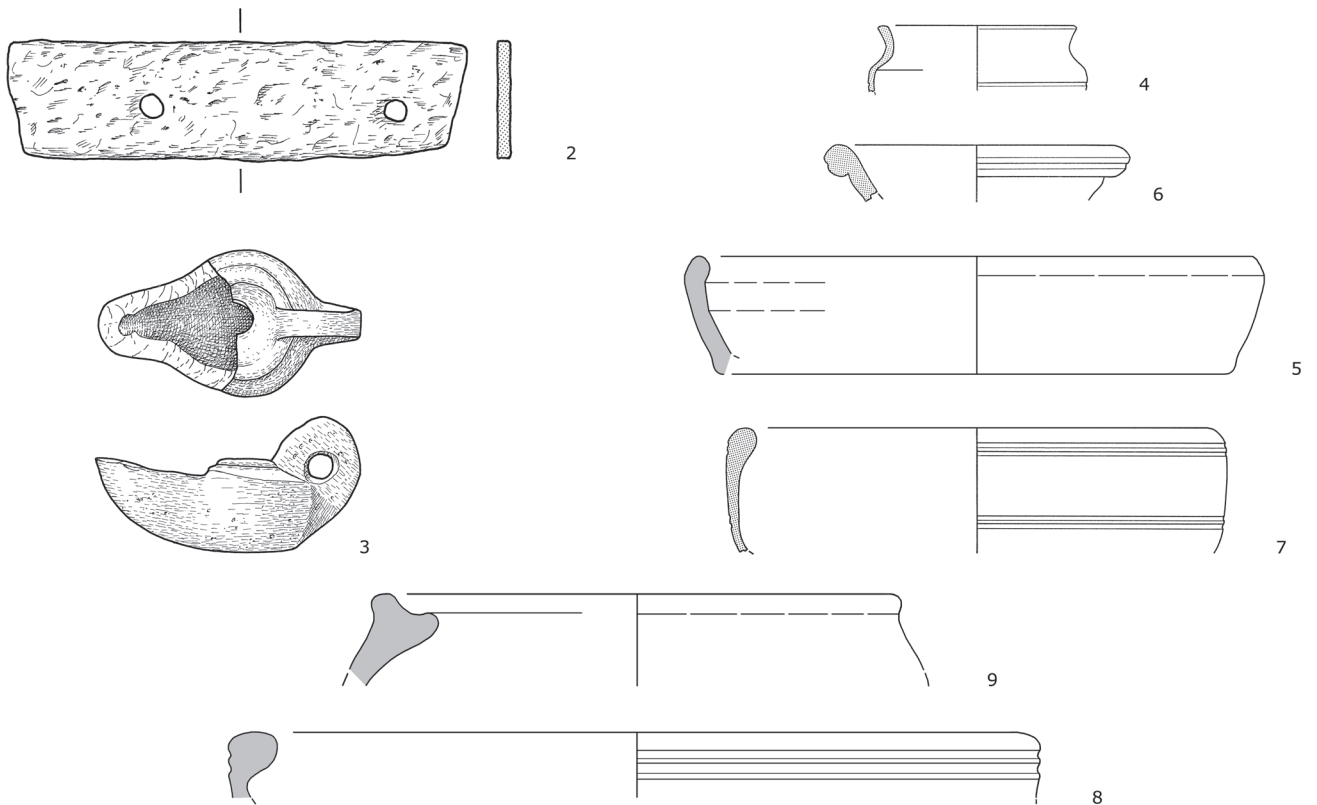

Grab 313



Nägel



1

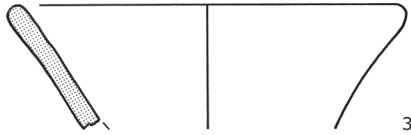

3

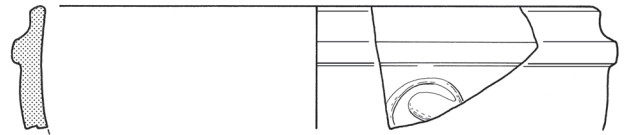

6

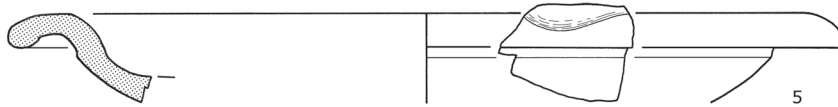

5

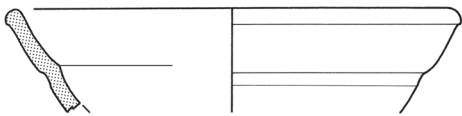

4

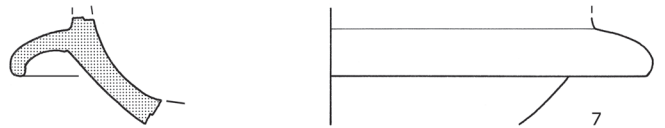

7

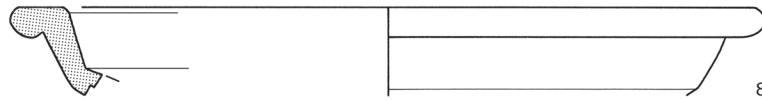

8

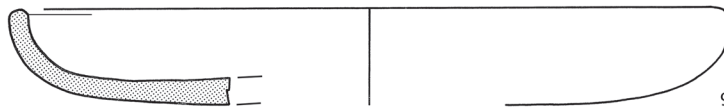

9

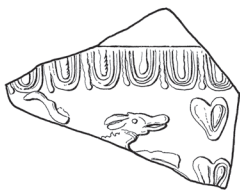

11

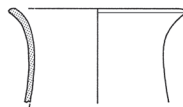

15

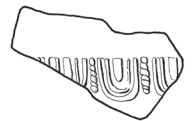

12

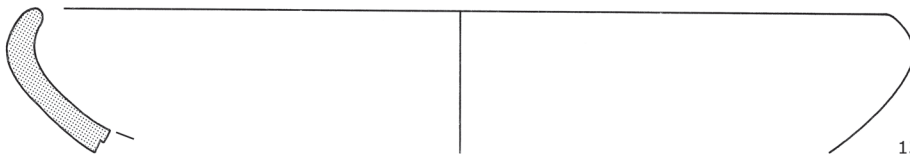

13

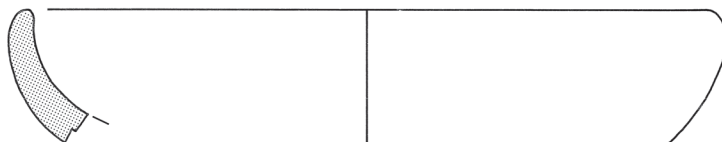

14

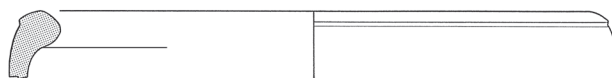

16

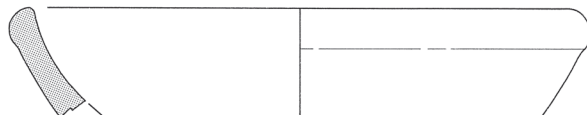

17

←
Grab 313

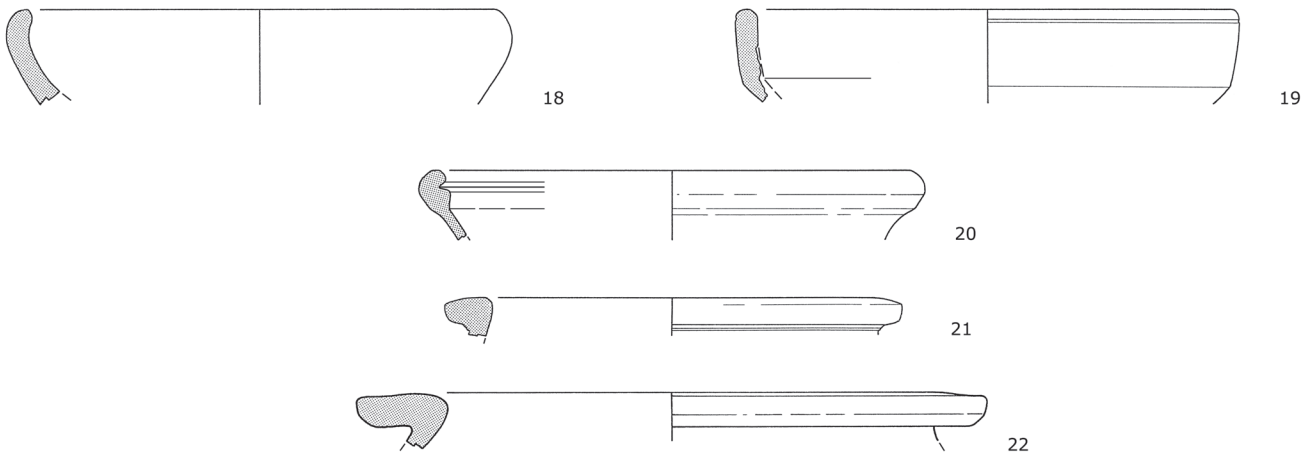

Grab 314

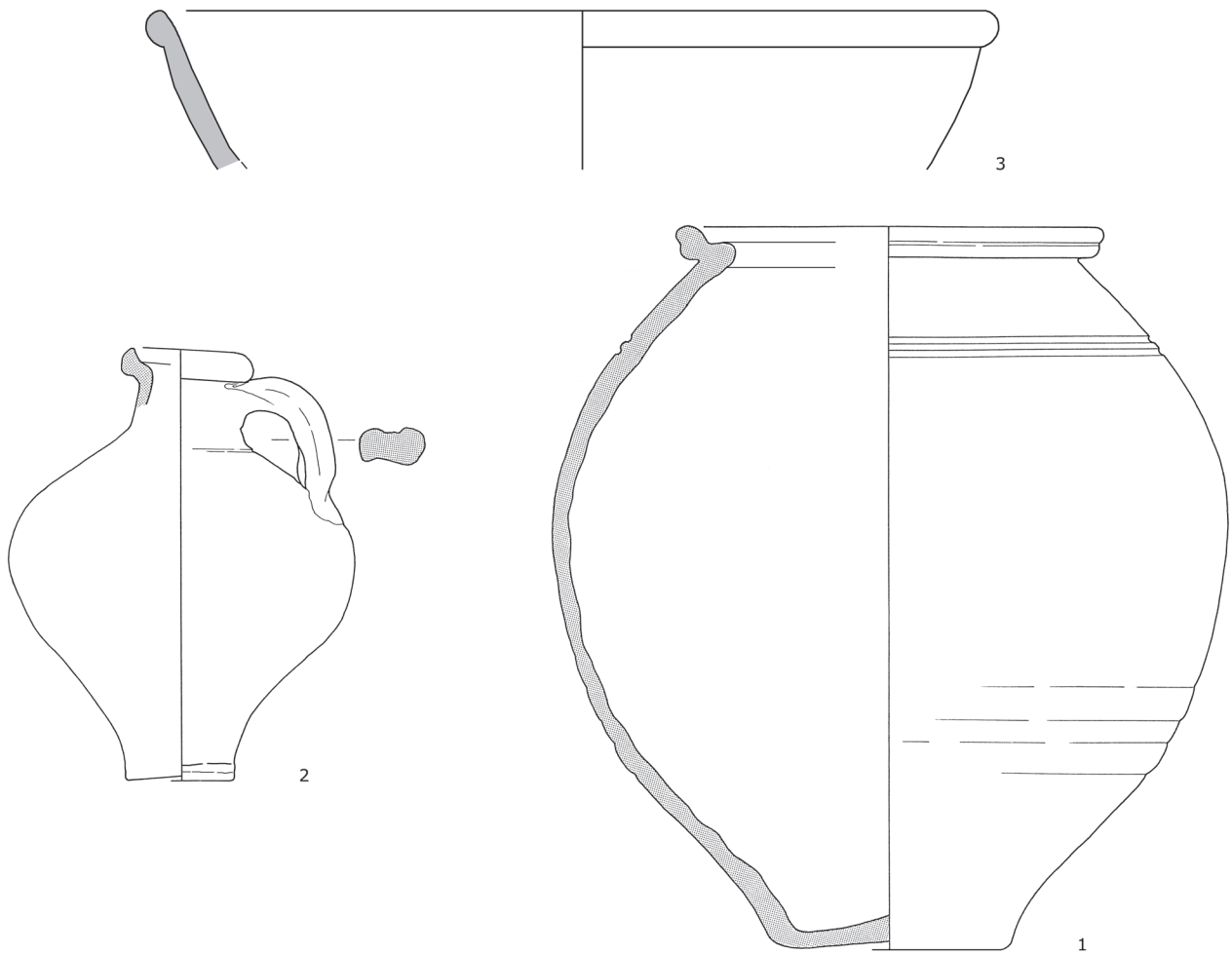

Grab 315



Grab 316



Nagel

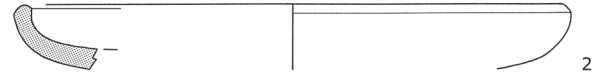
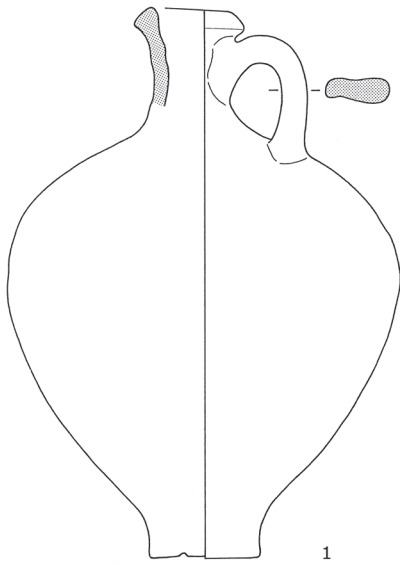

Grab 317



Schuhnägel
Nägel

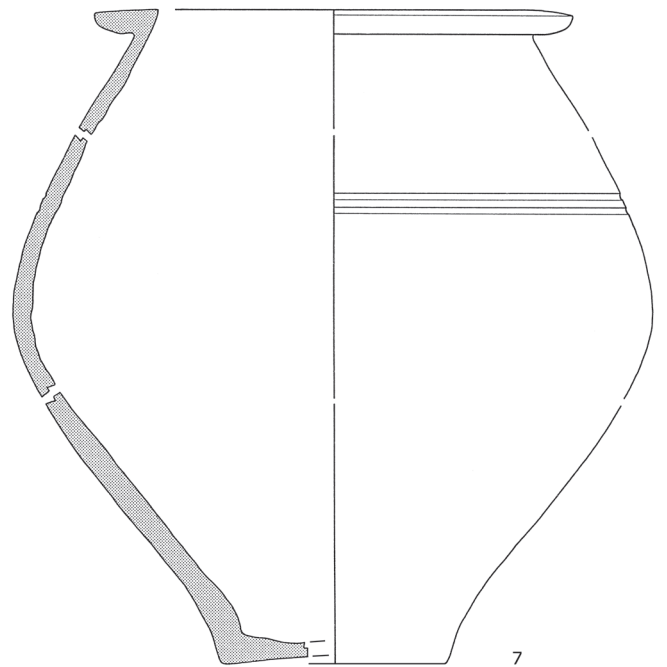
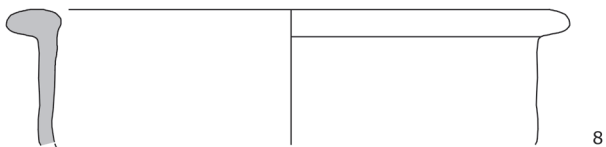
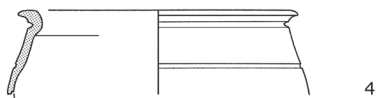
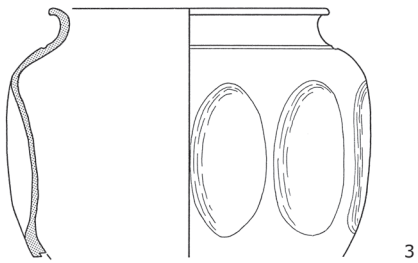
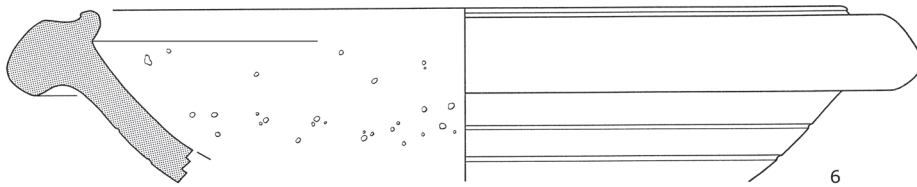

Fundstelle 318



Schuhnägel
Nagel

Grab 319



Sandstein

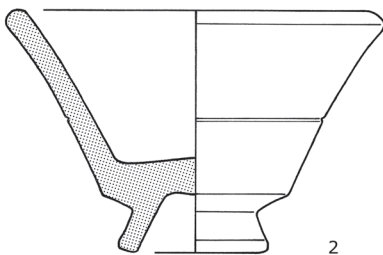
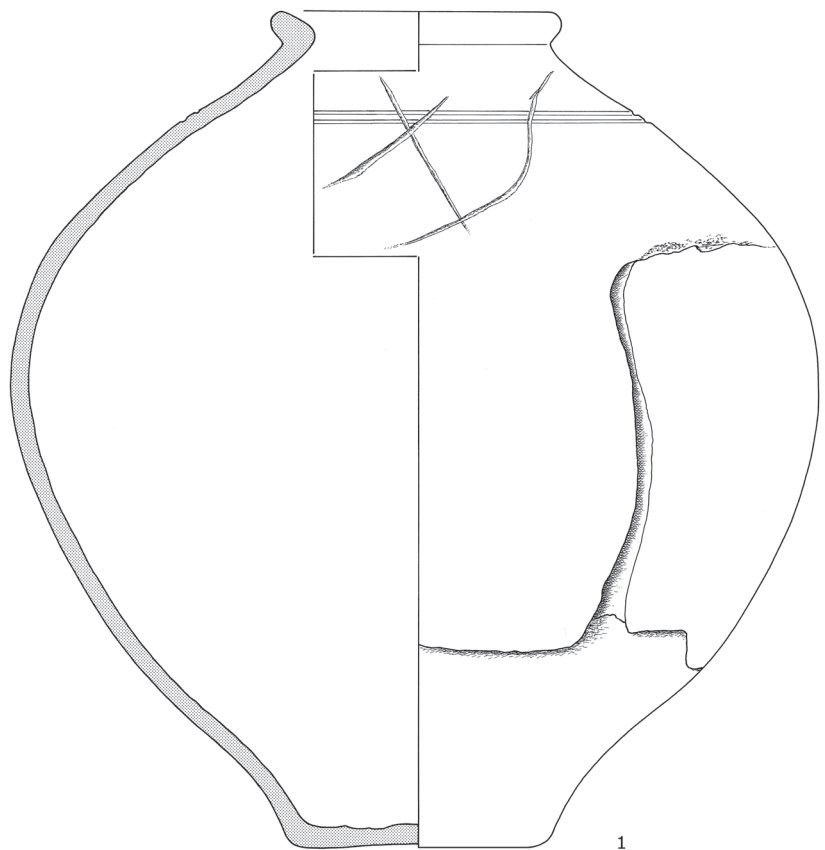
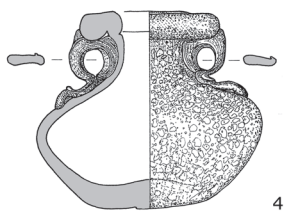
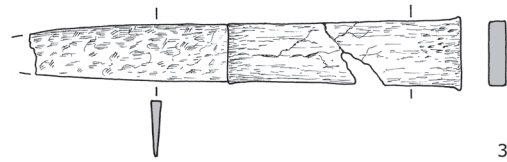
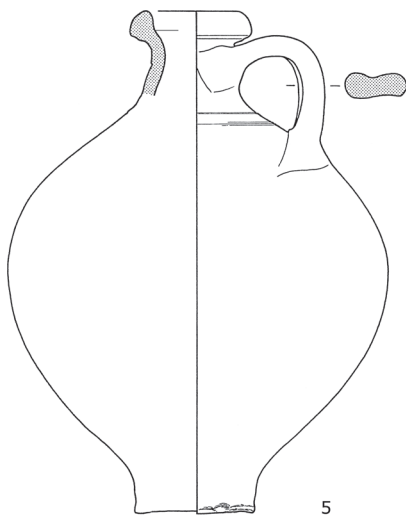

Grab 320



Glas
Nagel
Bronzedraht

Commodus
180-183 n.Chr.

7

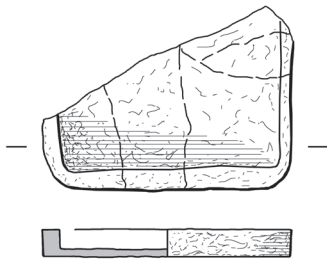

6

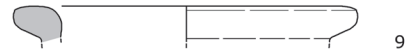

9

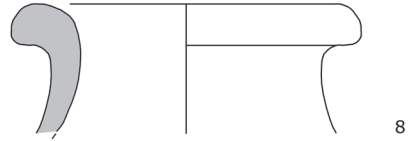

8

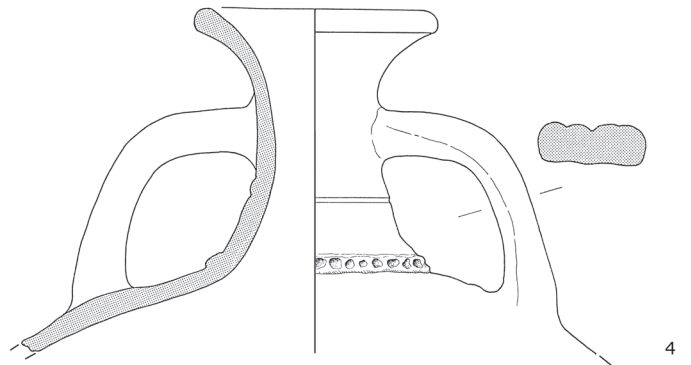

4

Grab 321



Nagel
Keramik



Commodus
177-192 n.Chr.

1

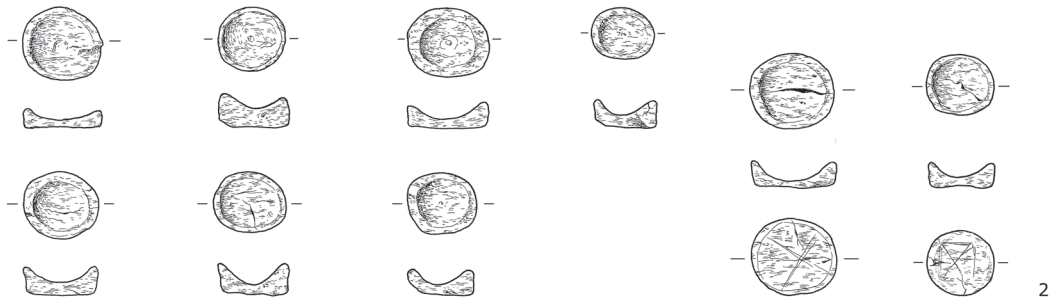

2

Grab 322



Keramik



Grab 323



Kalkstein



Trajan
98-102 n.Chr.

1

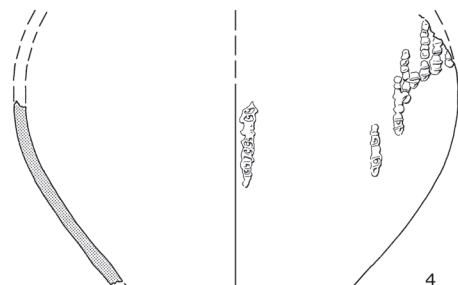

4

← Grab 323

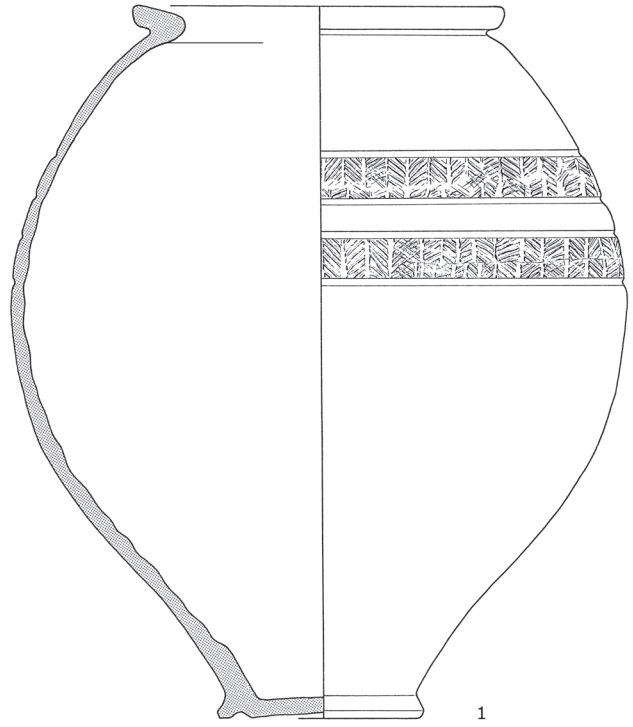
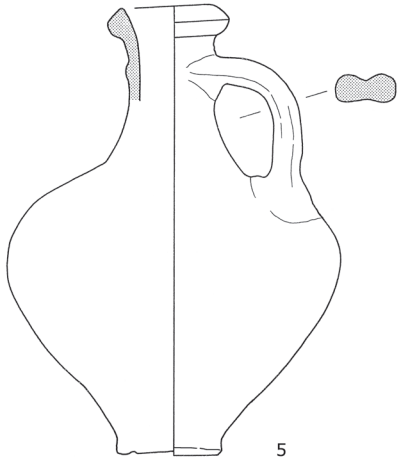

Fundstelle 324

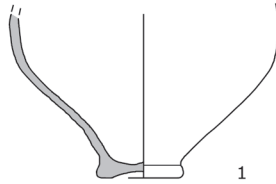

Grab 325



→ Grab 326

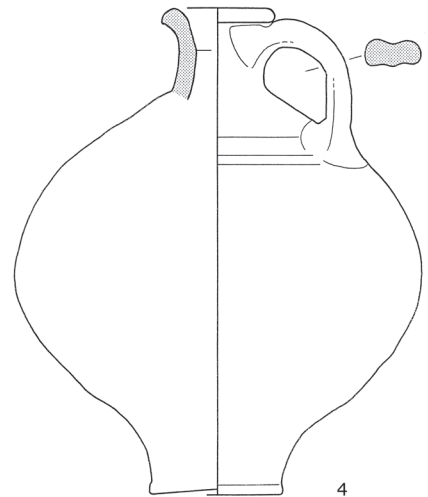
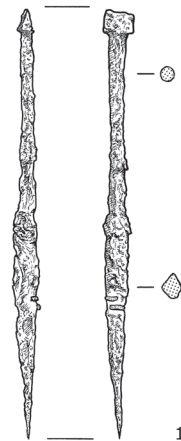
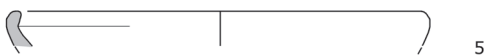

← Grab 326

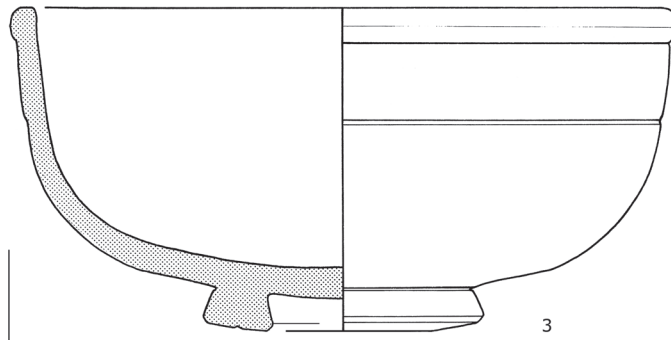

Grab 327



Nägel

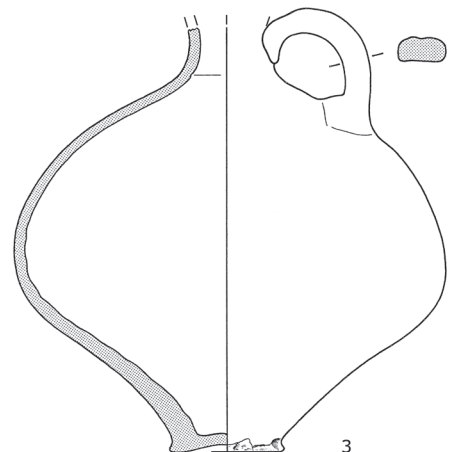
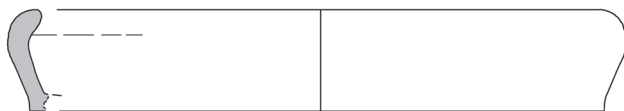
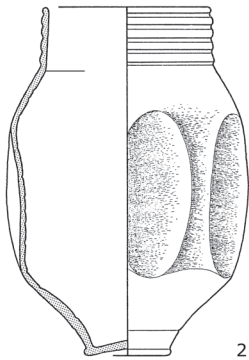

Grab 328



Nagel

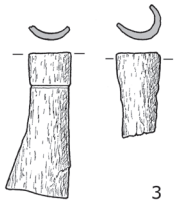

3

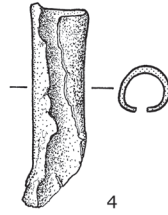
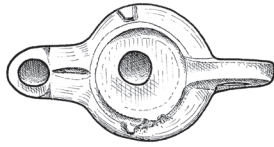

4

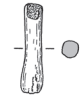

5



6



7



10

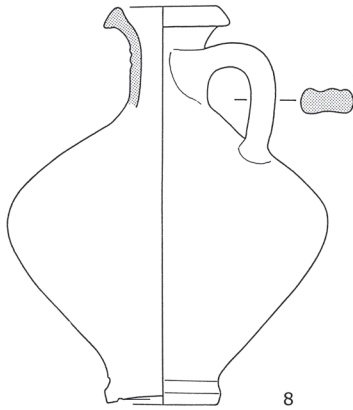

8

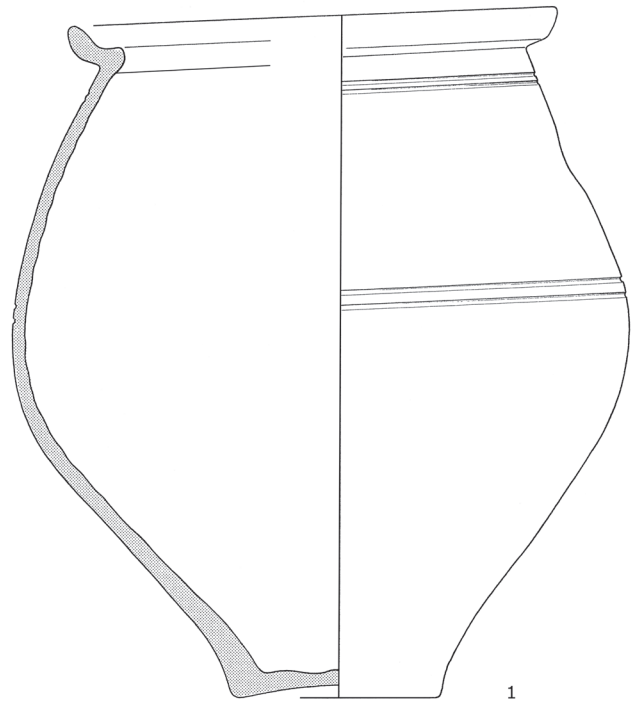

1

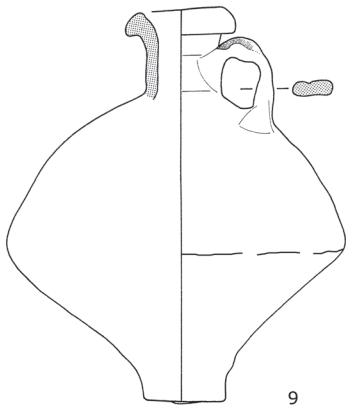

9

Grab 329 A



Sandstein

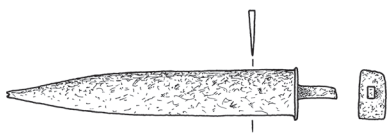

1

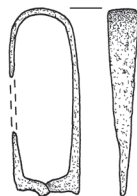

2



3

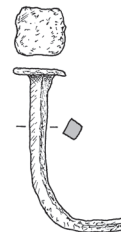

4

← Grab 329 A

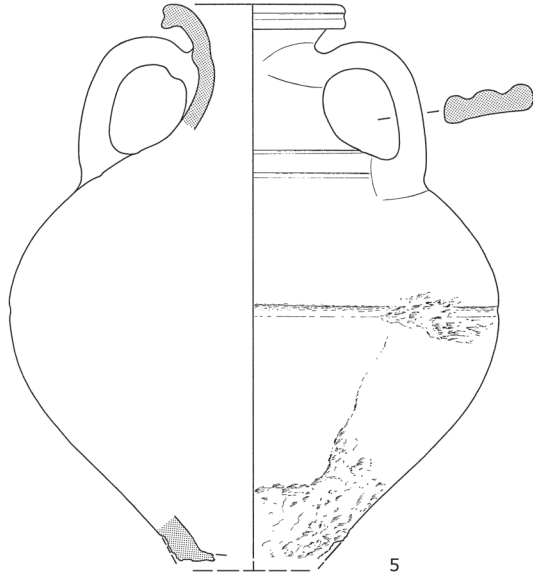

Grab 329 B

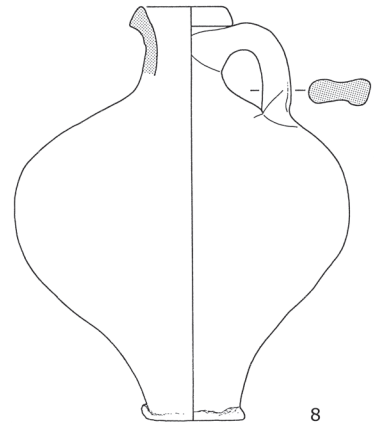
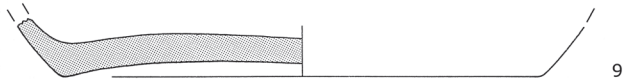
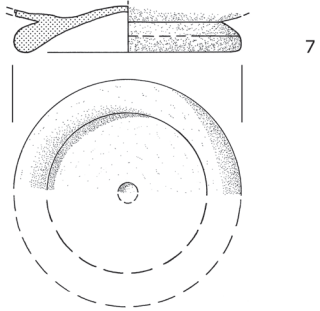

Grab 330

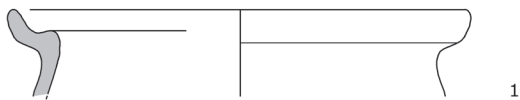

→ Fundstelle 331

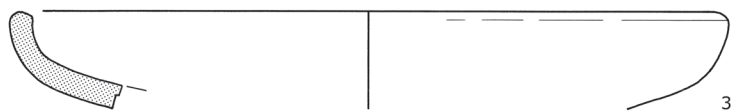

← Fundstelle 331

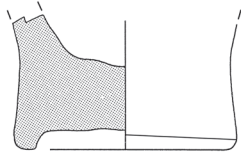

5

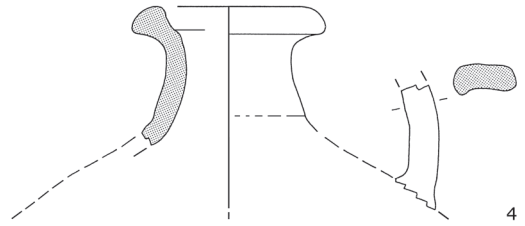

4

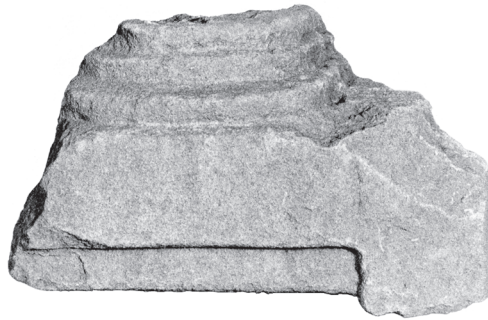

7



Grab 332

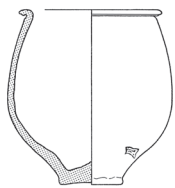

1



2

→ Grab 333



Schuhnagel
Nägel
Bronzedraht



10

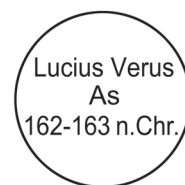

11

Grab 333

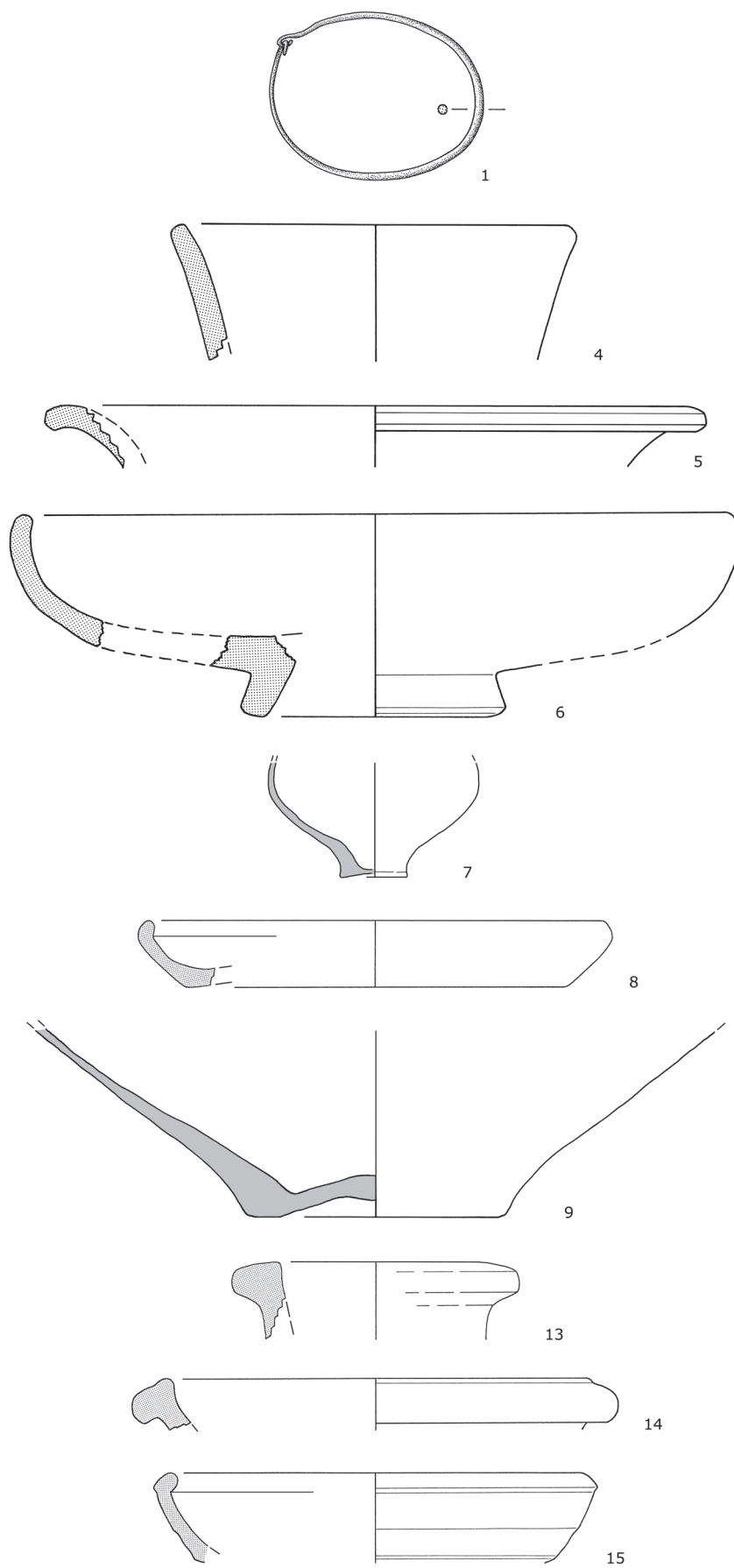

Grab 334



Nägel

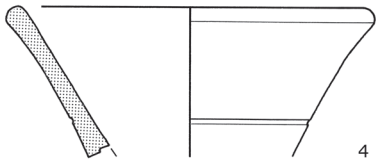

4

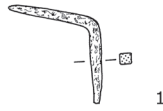

1

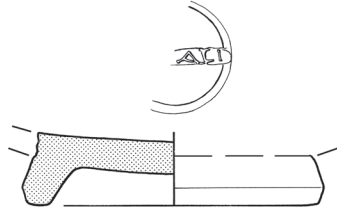

5



6



7



8



9



11



12



13



14

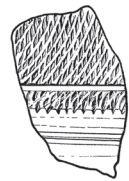

16

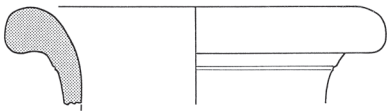

18

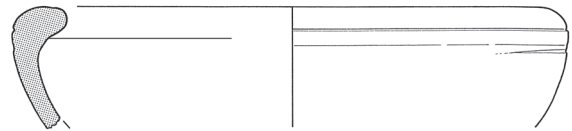

19

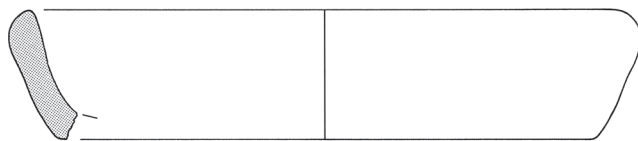

20

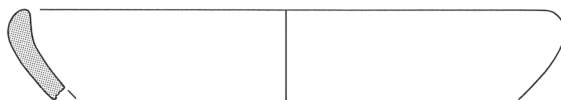

21

← Grab 334

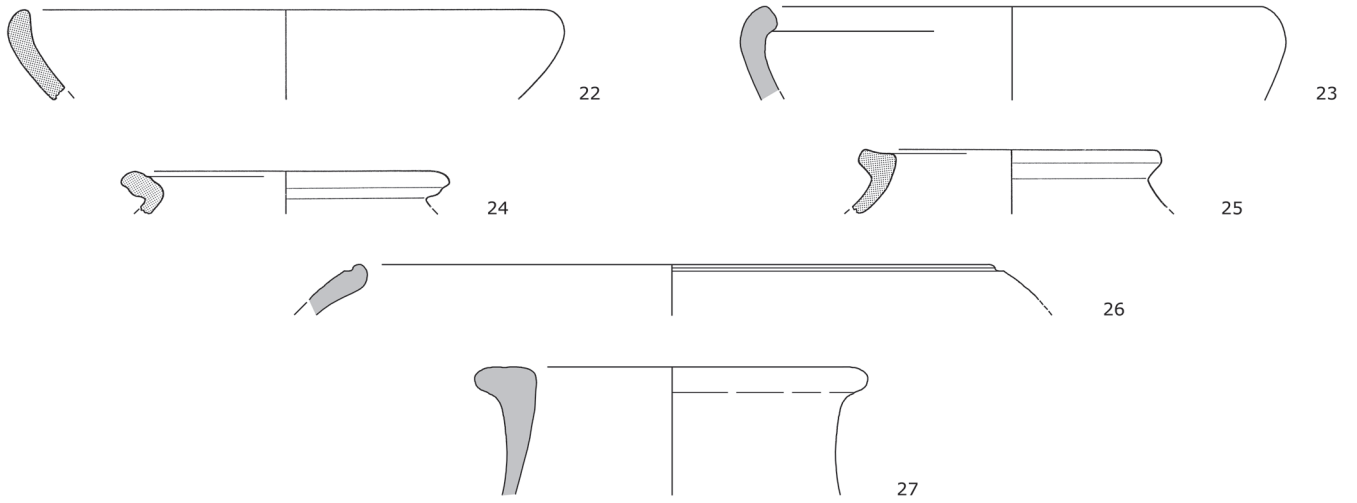

Grab 335



Ziegel
Sandstein

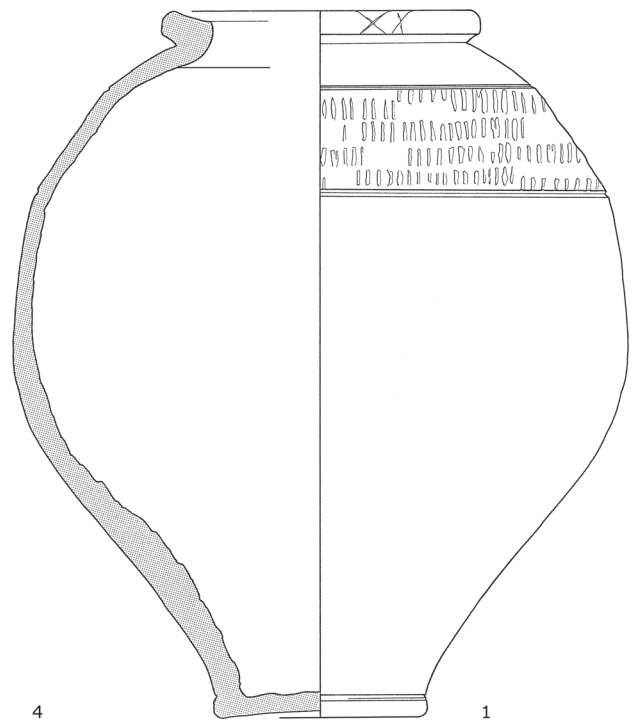
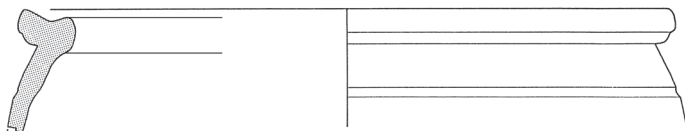
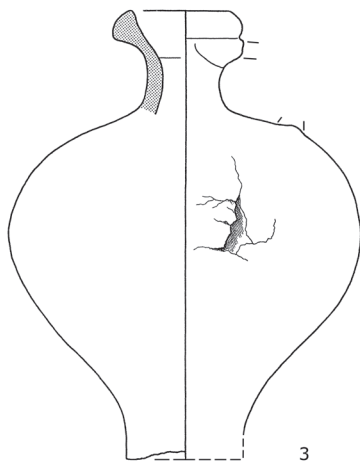
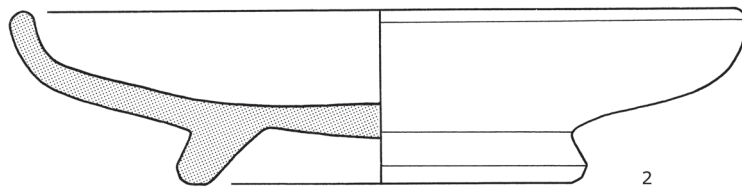

Grab 336

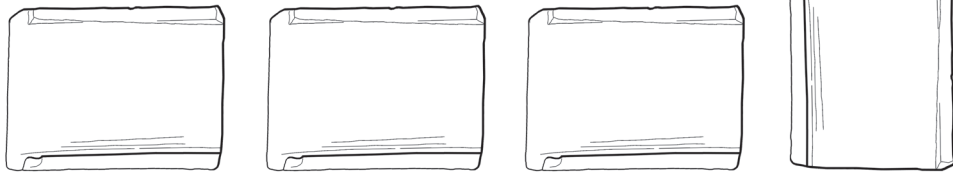
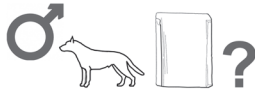

1

Grab 337



Nagel

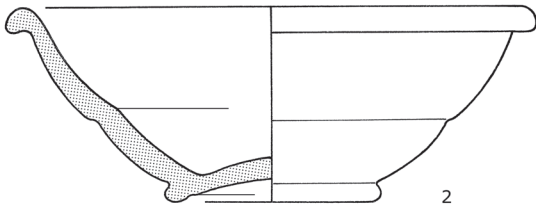

2

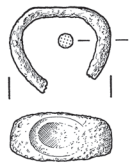

3



4



5

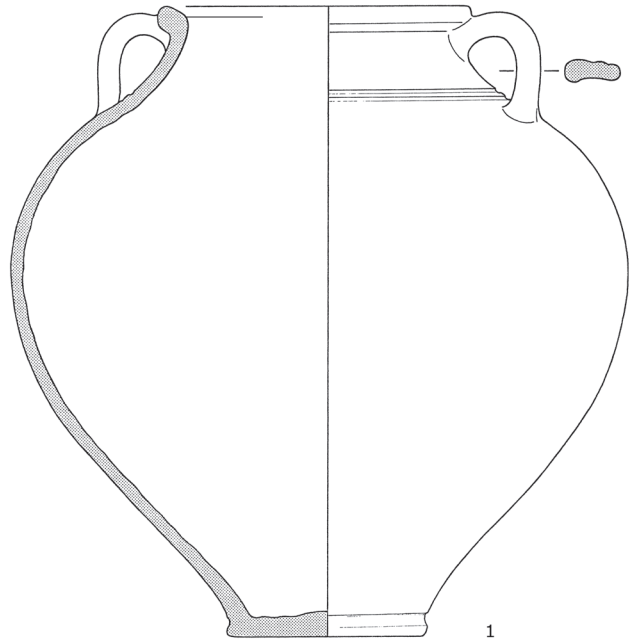

1

Grab 338

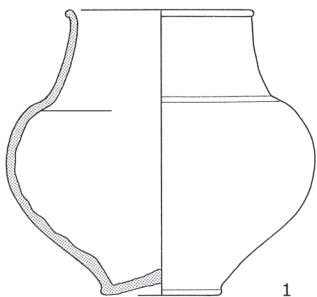

1

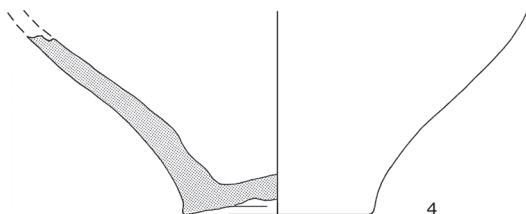

4

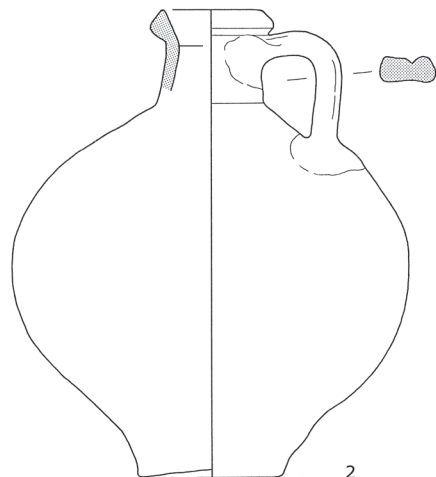

2

Grab 339

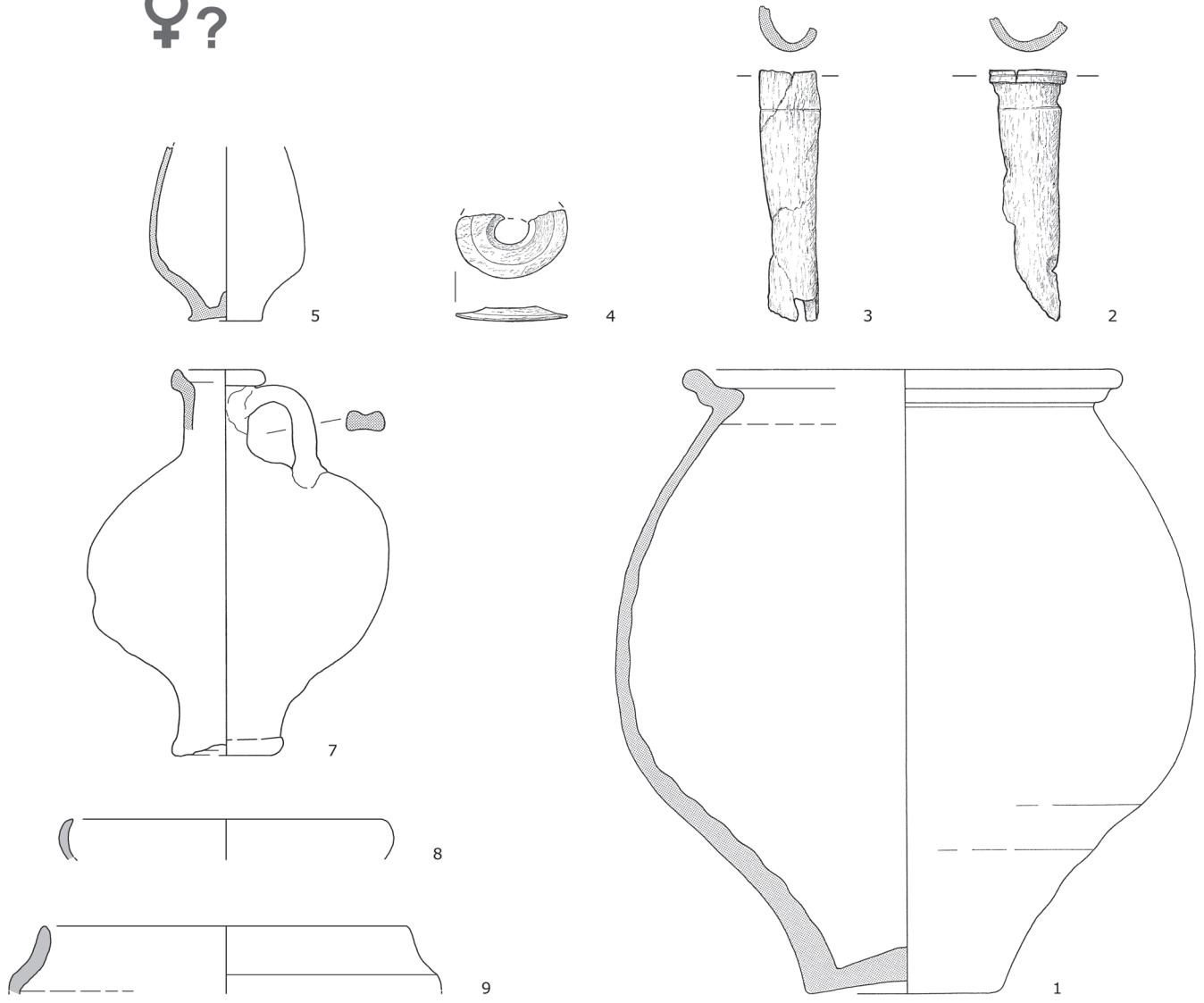

Grab 340



Schuhnägel
Nagel

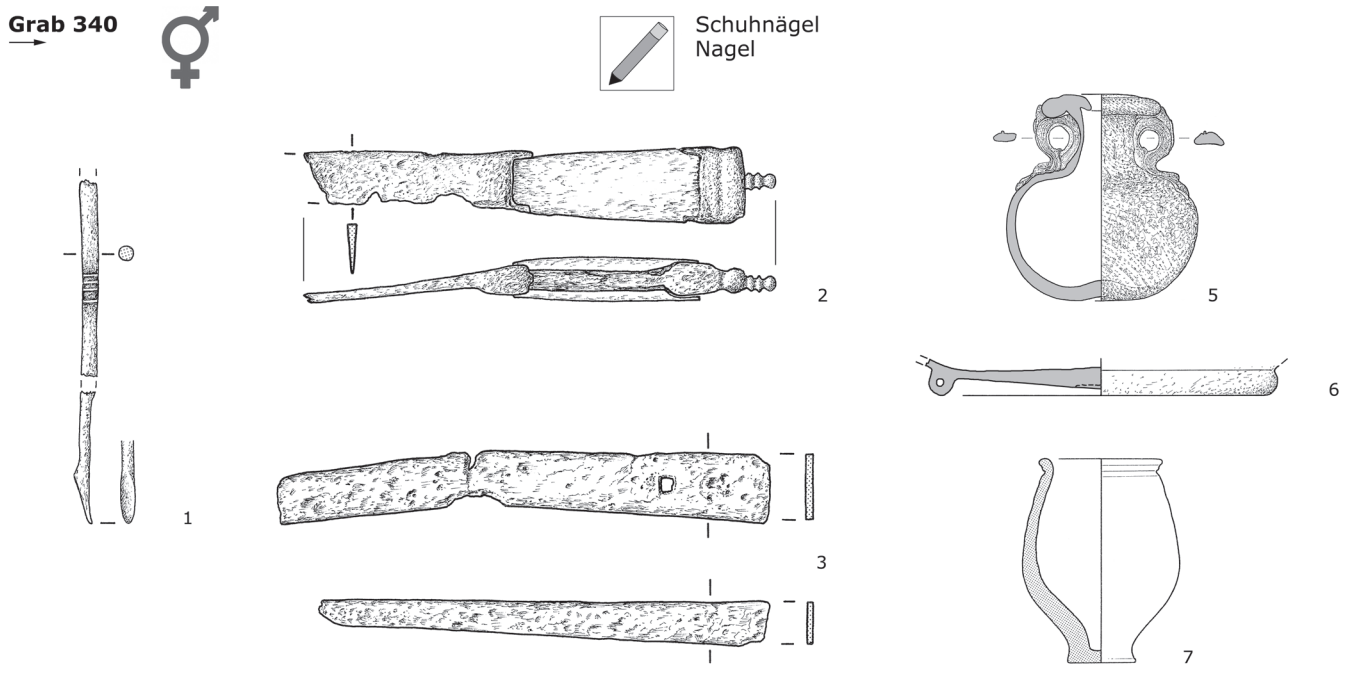

← Grab 340

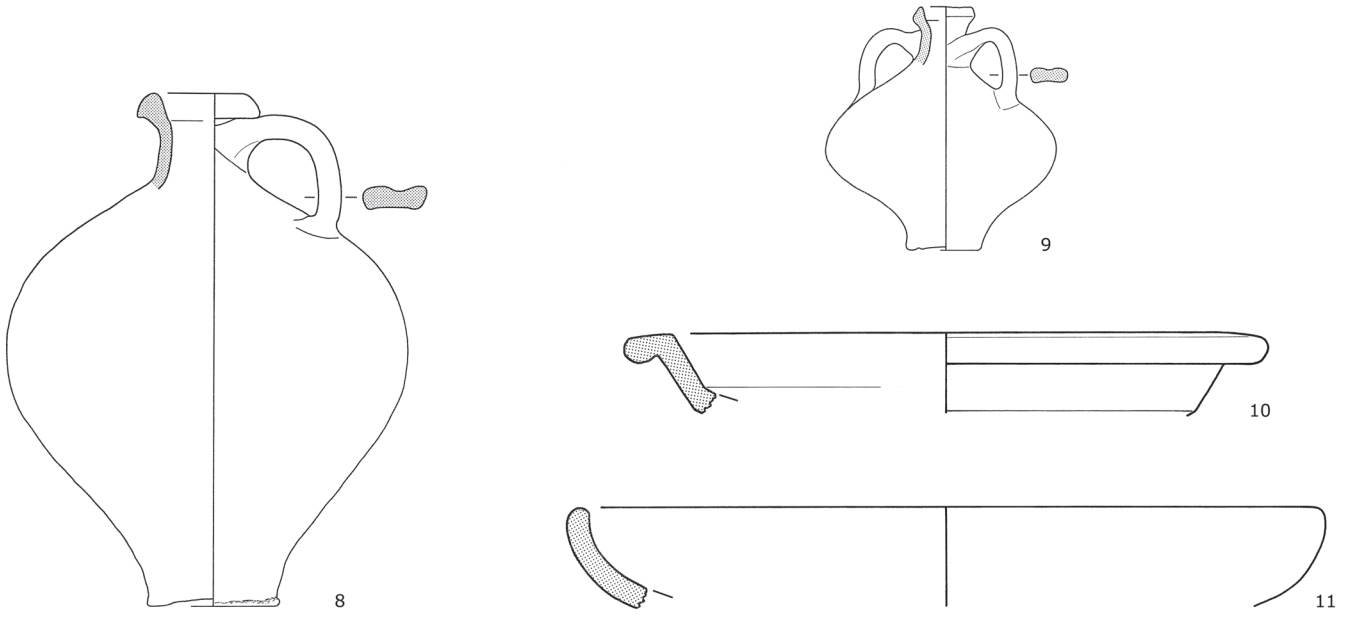

Grab 341

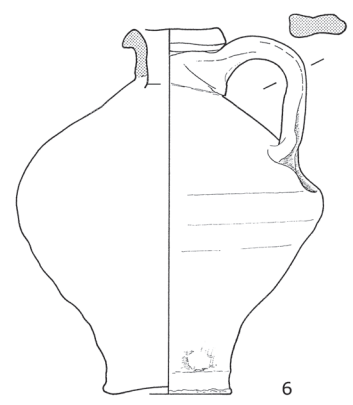
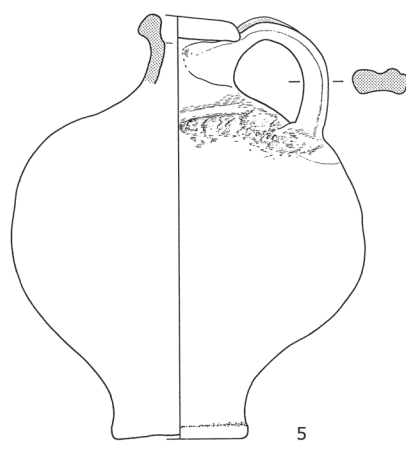
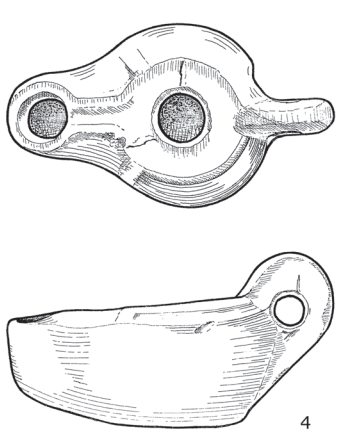
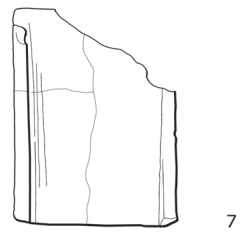
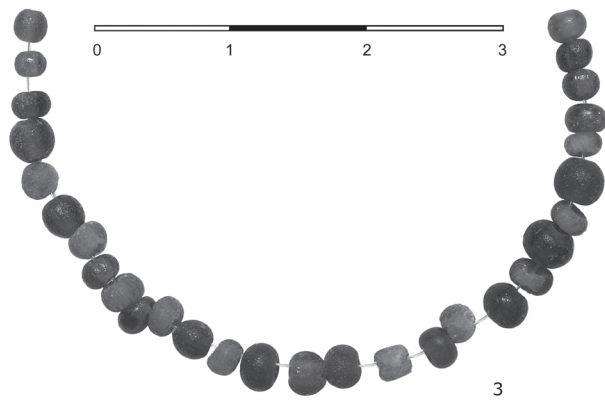

Grab 342



Glas
Nägel
Keramik
Sandstein

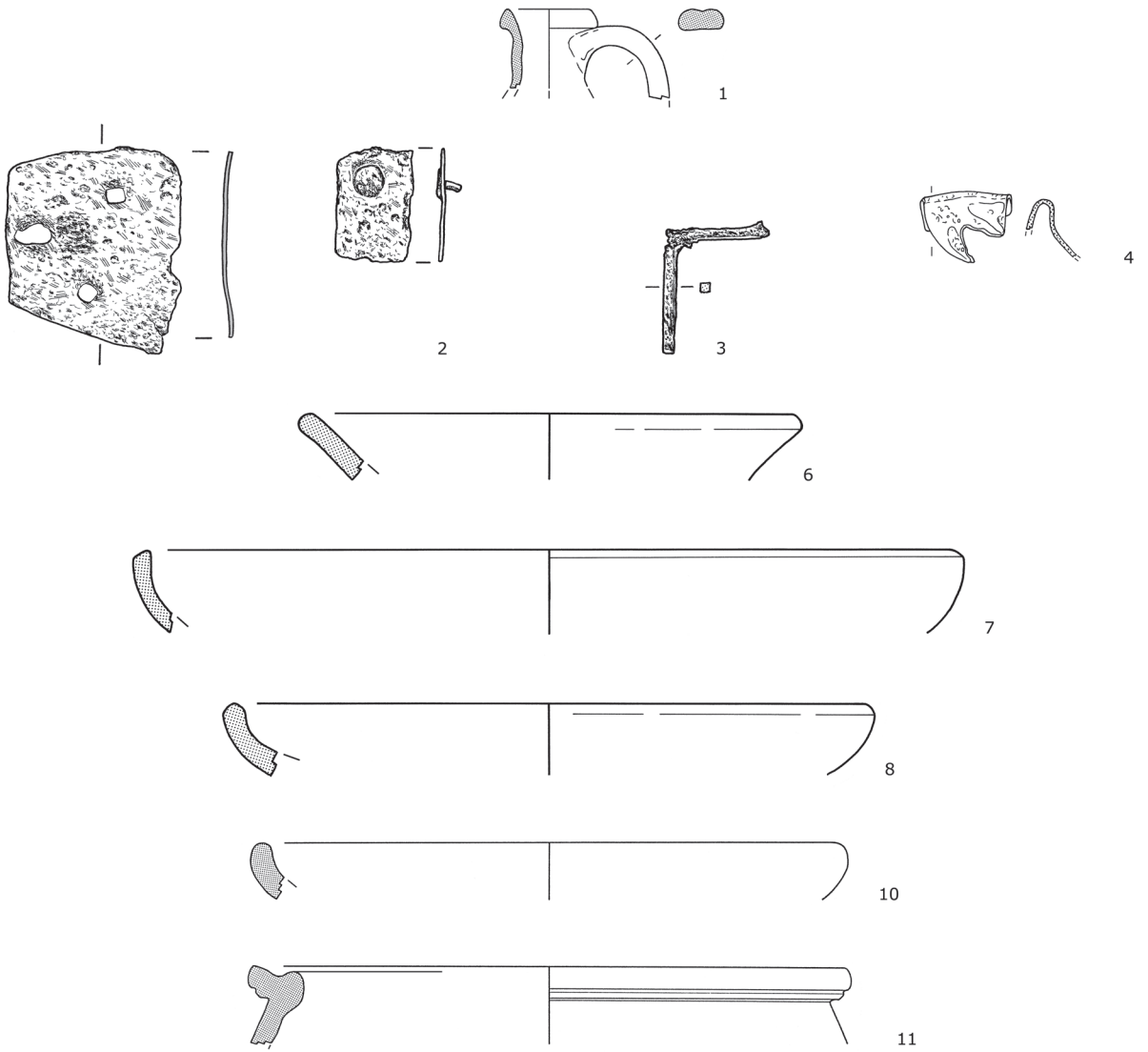

Grab 343



Grab 344



Nägel
Keramik

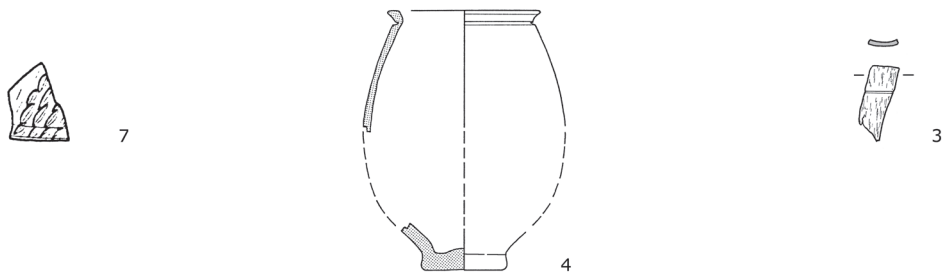

← Grab 344

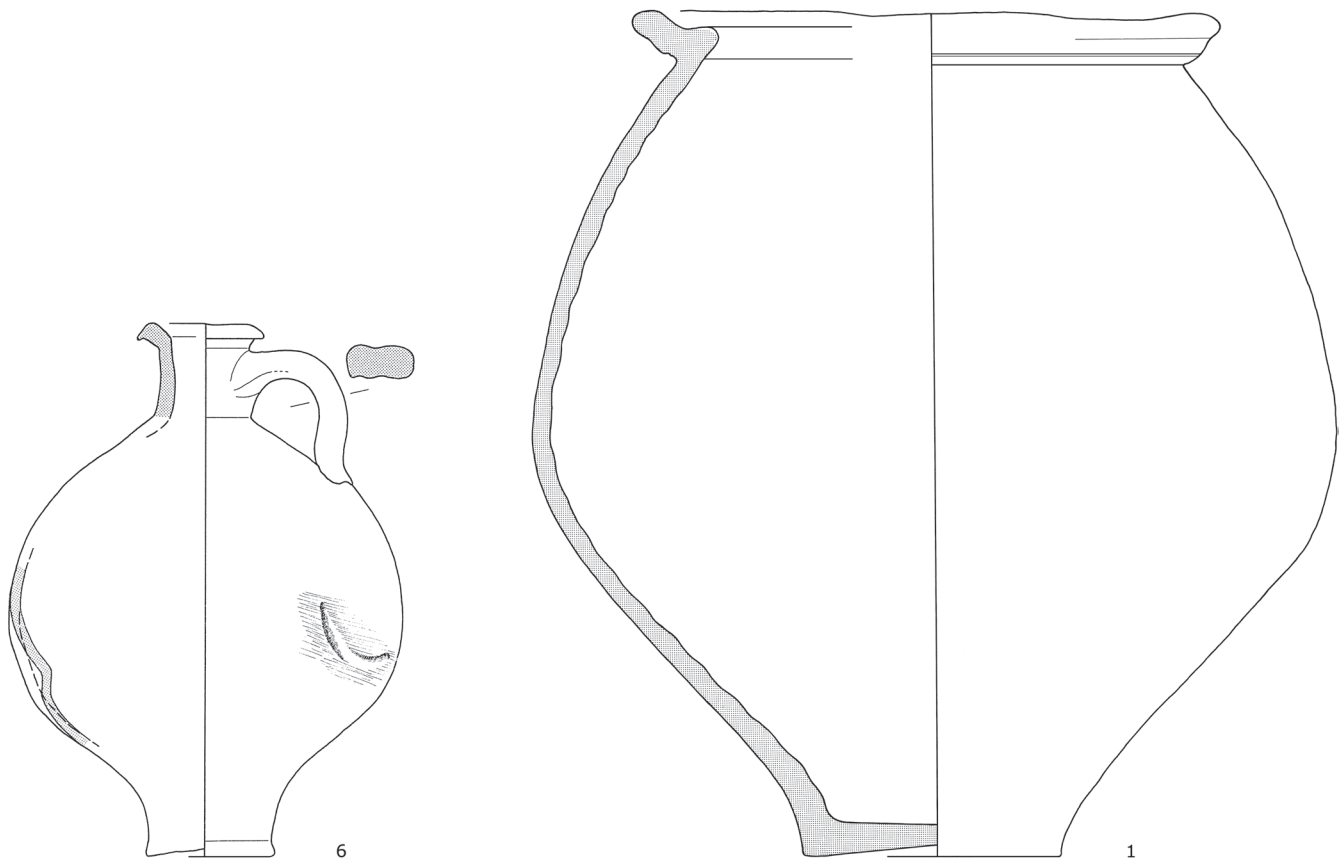

Fundstelle 345



Nägel
Sandstein

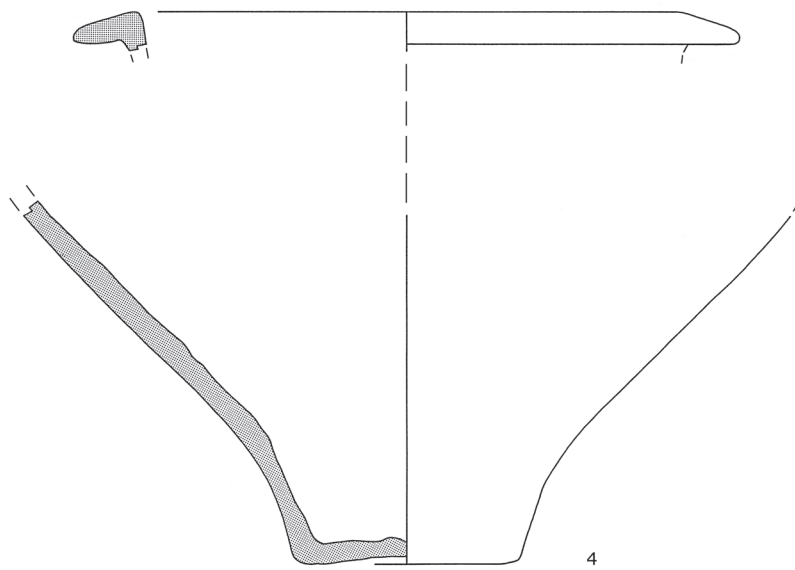

Grab 346



Keramik

Grab 347



Glas

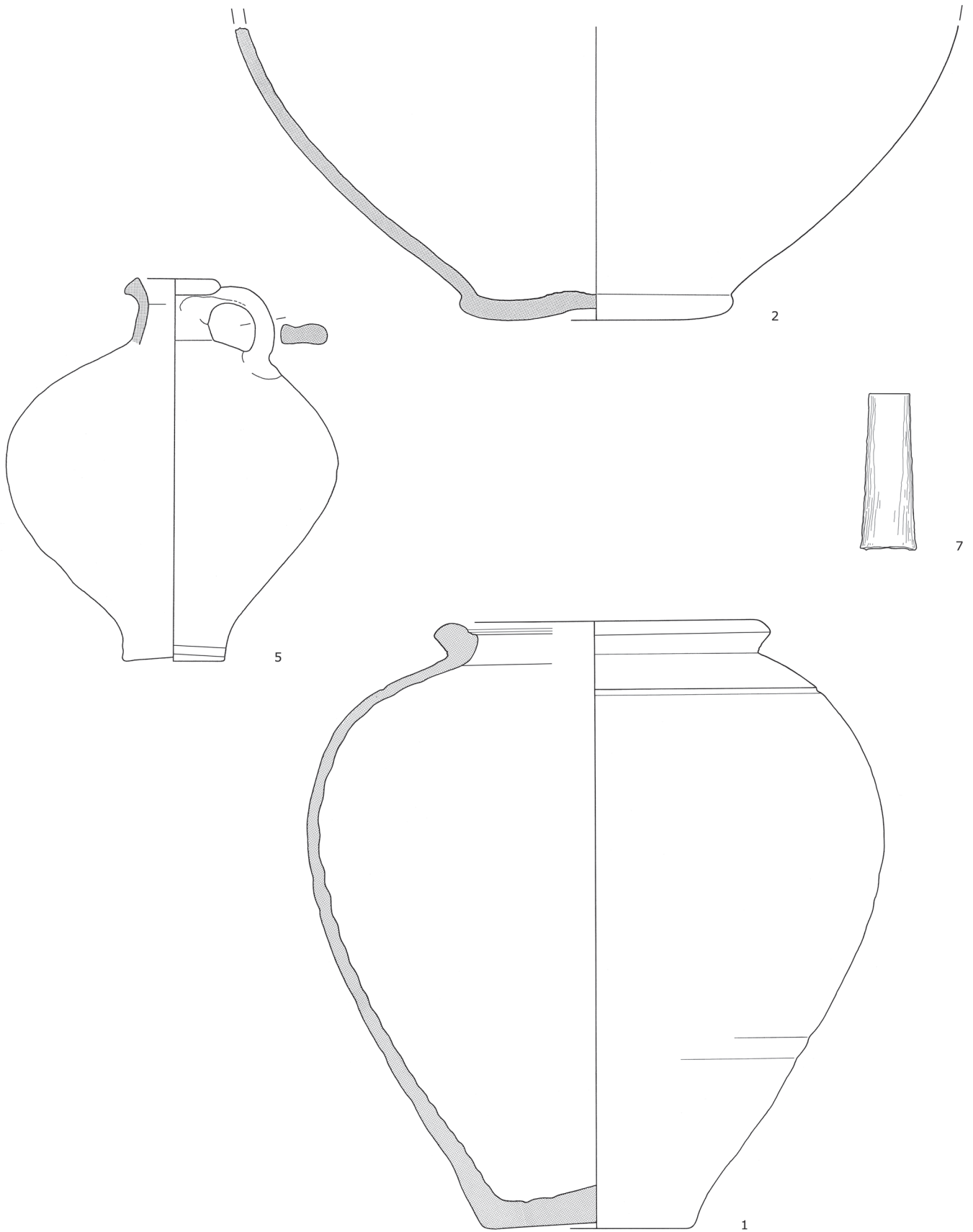

Grab 348 A



Schuhnägel
Nägel

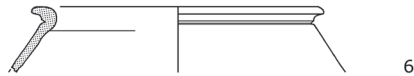
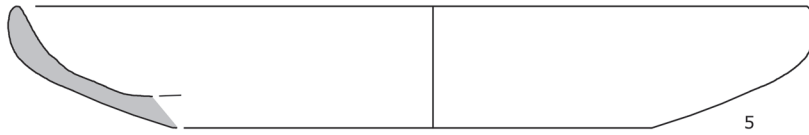
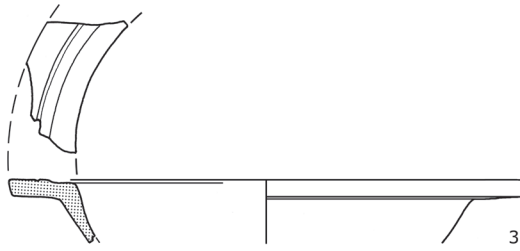

Grab 348 B

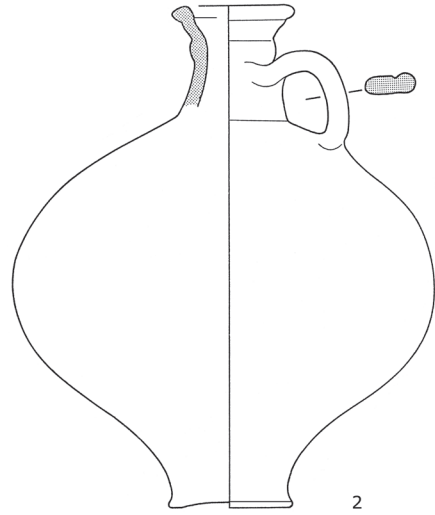
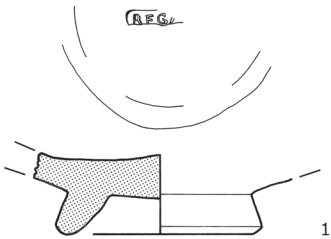

Grab 349



Schuhnägel
Nägel

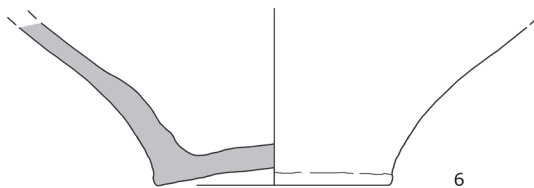

Grab 350



?O

Grab 351



Ziegel

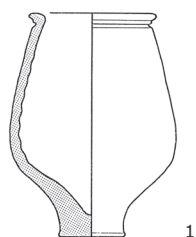

1

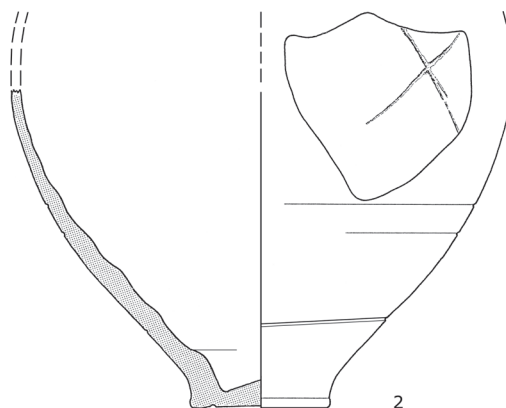

2

Grab 352



Nagel

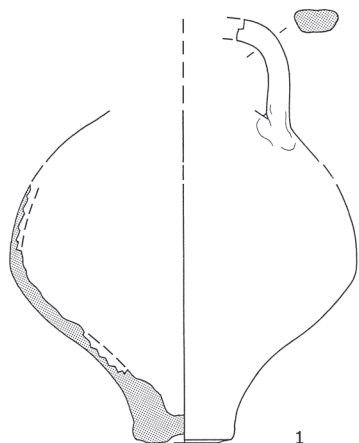

1

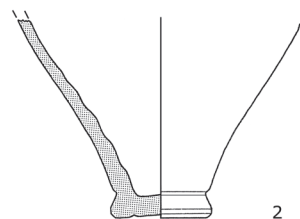

2

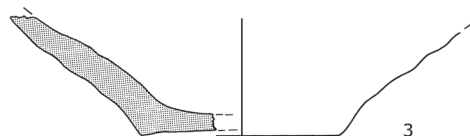

3

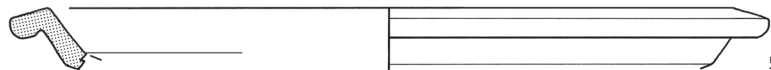

5

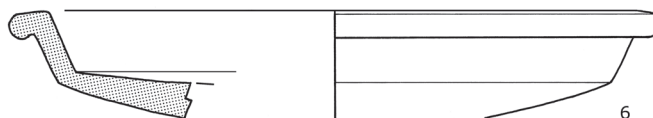

6

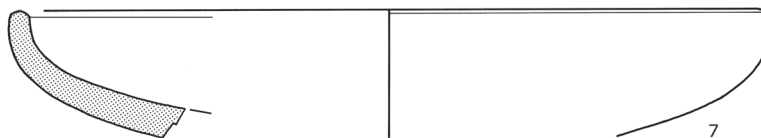

7

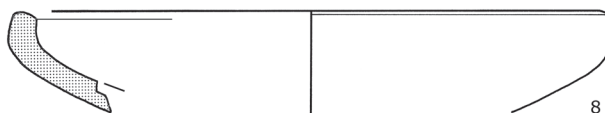

8

← Grab 352

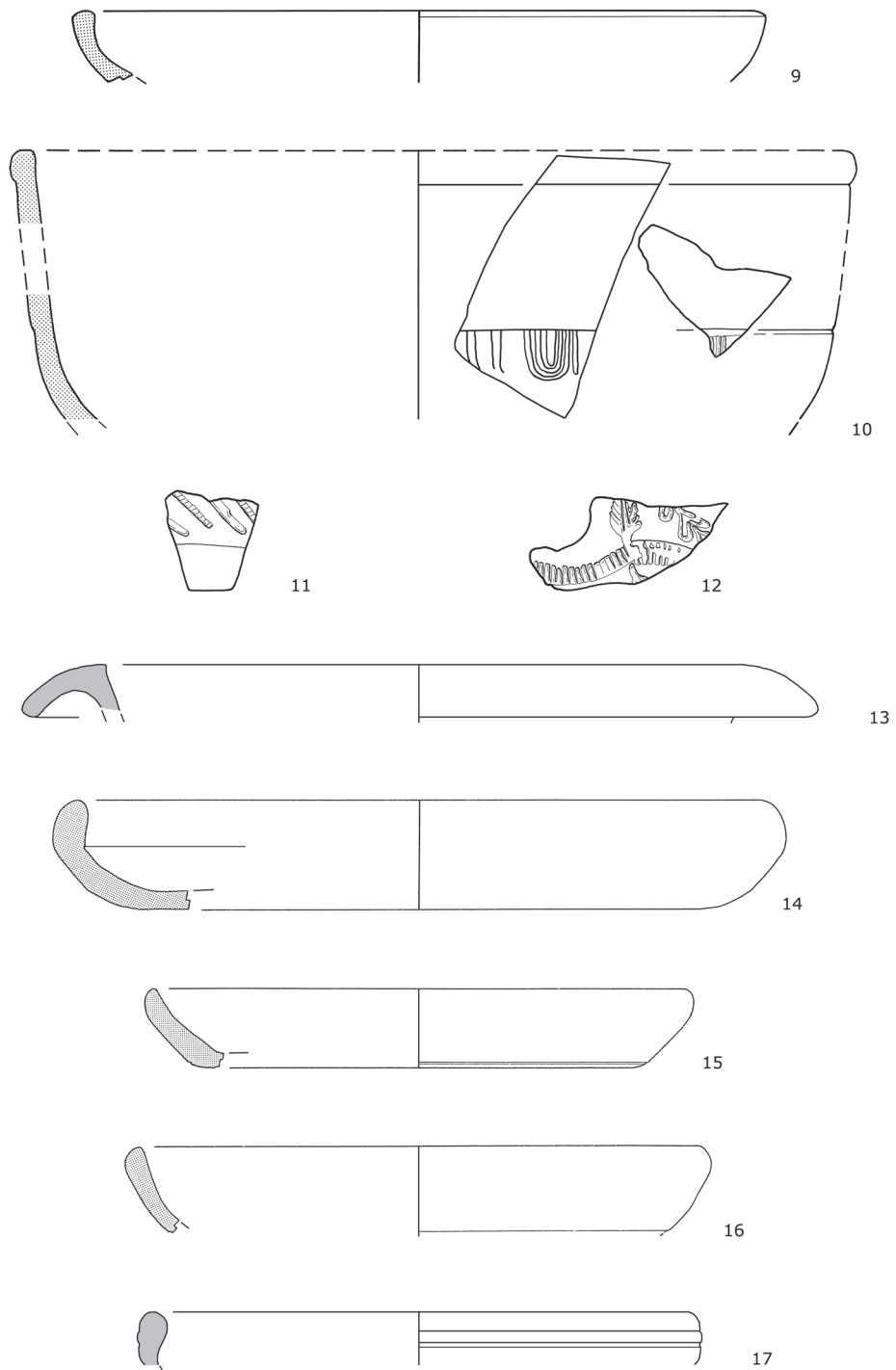

Grab 353



Nagel
Keramik



Grab 354



Nagel
Keramik

Grab 355



Nagel

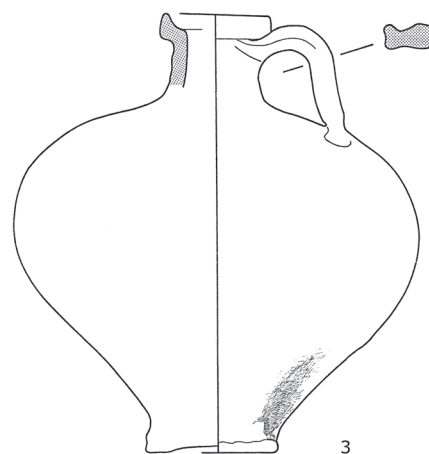
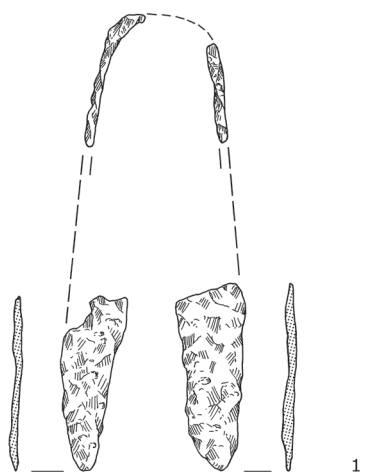

Grab 356



Nagel

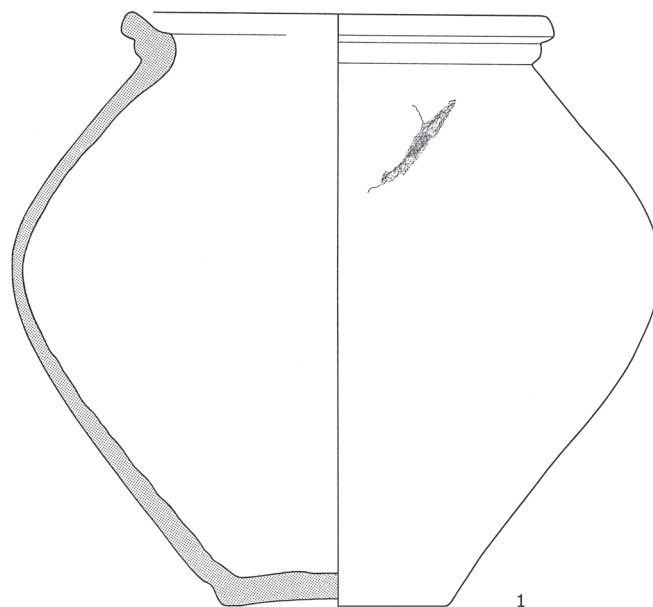
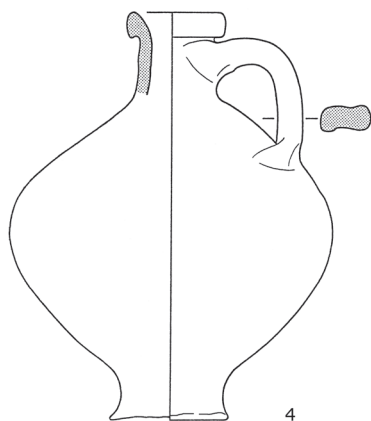
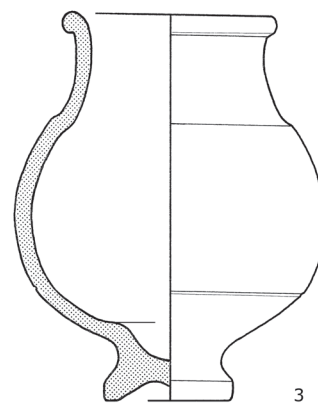
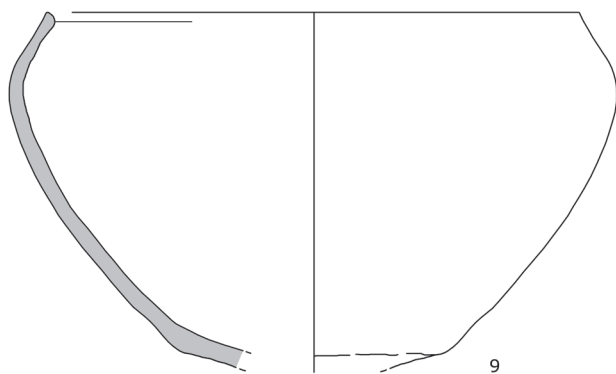

Grab 357



Domitian
Dp.
86-96 n.Chr.

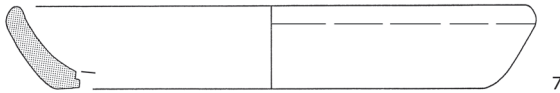
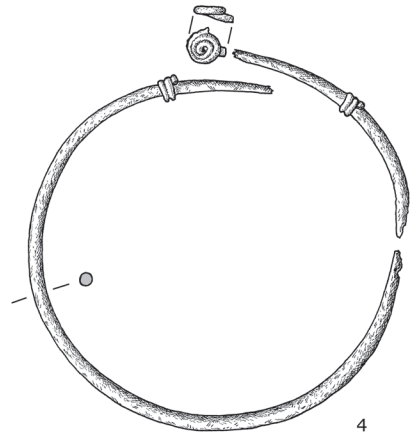
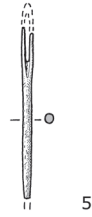
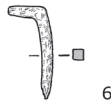

Grab 358



Nagel

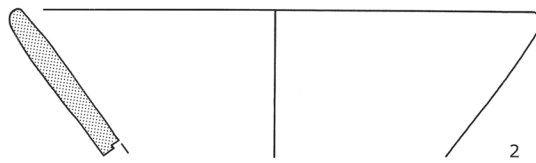

Grab 359



Nagel

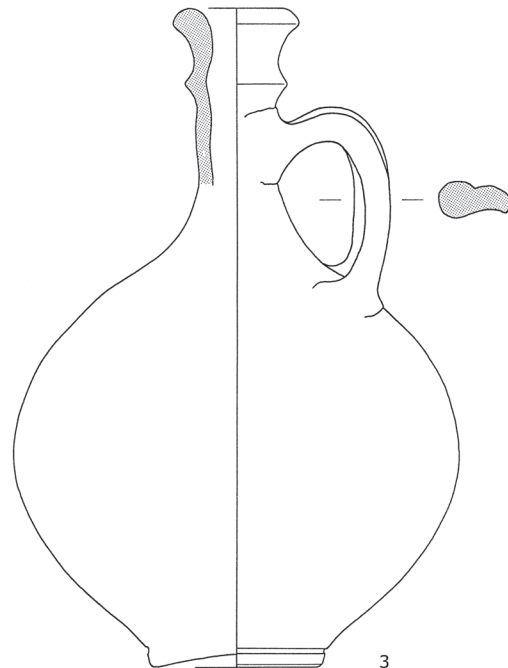
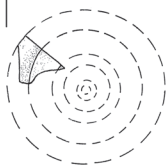
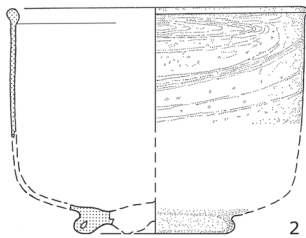
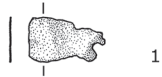

Grab 360



Nagel



Grab 361



Keramik

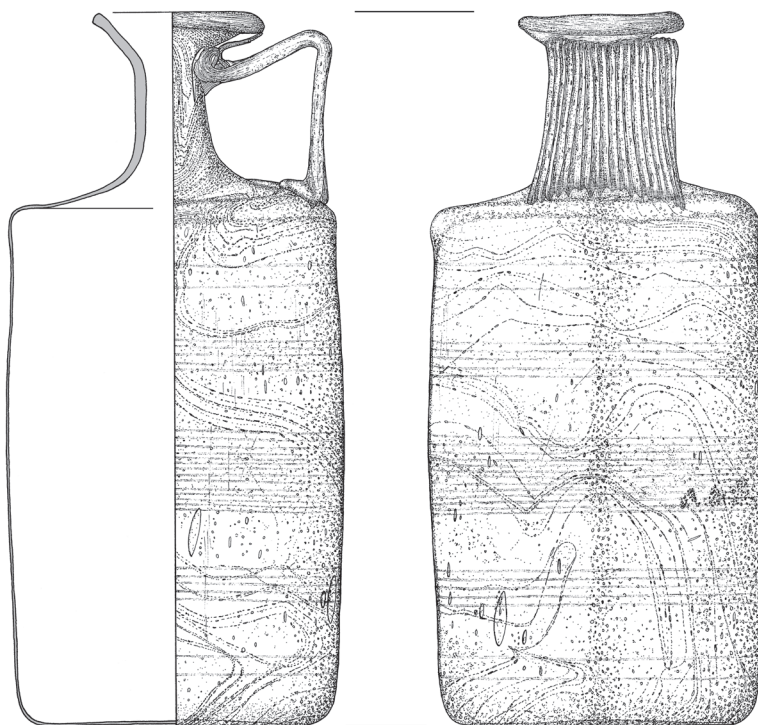

1

Grab 362



Nagel

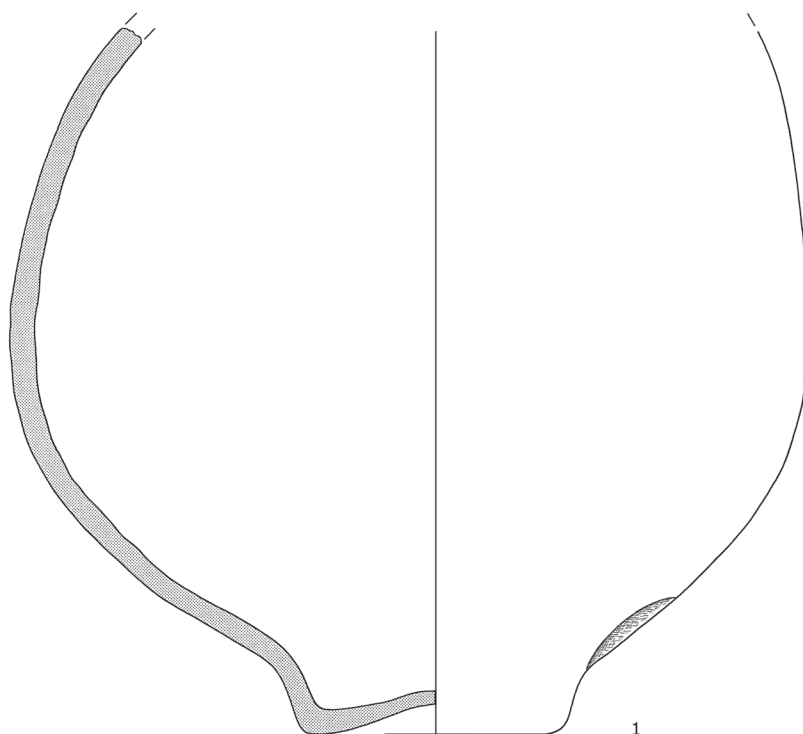

1

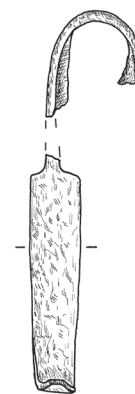

6

← Grab 362

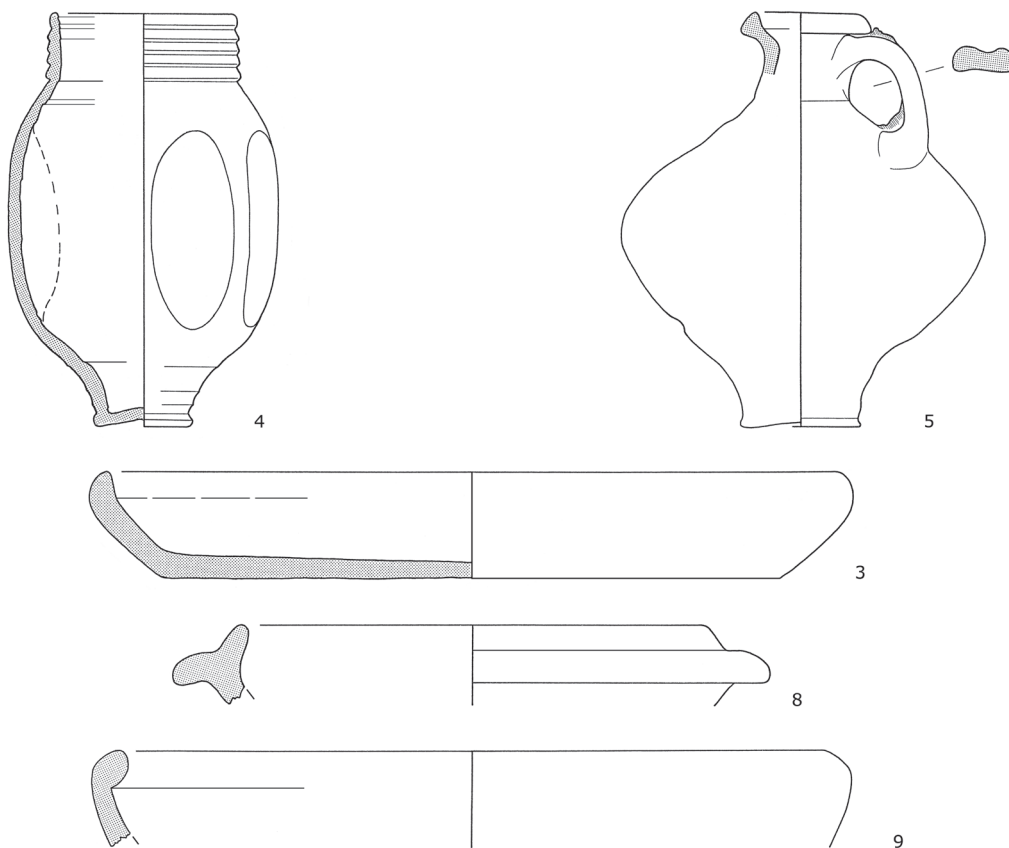

Grab 363

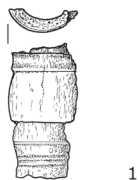

Grab 364



Grab 365



Nägel
Ziegel

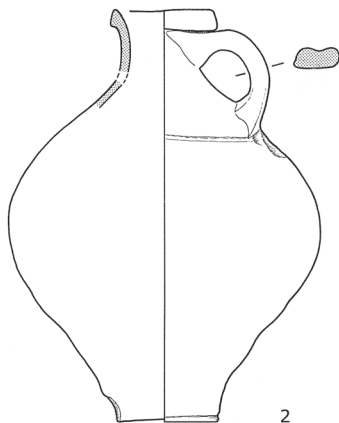

Grab 366



Nägel
Bronze
Wandputz

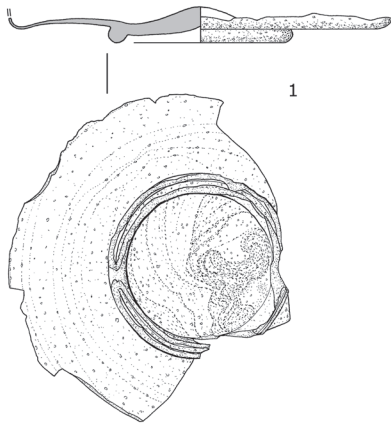

2

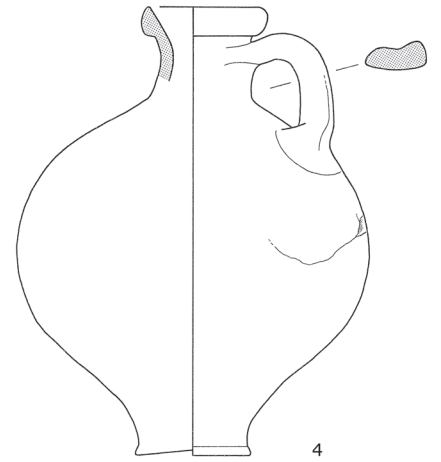

4

Grab 367



Schuhnägel
Nägel

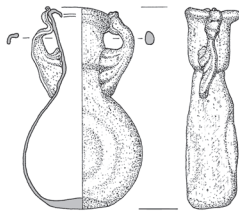

4

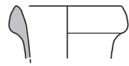

10

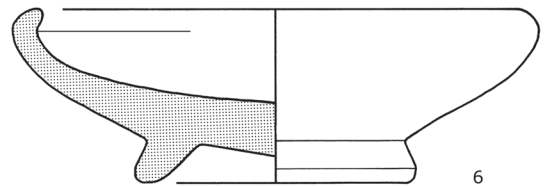

6

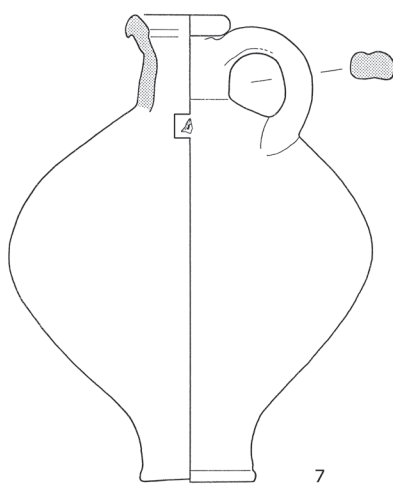

7

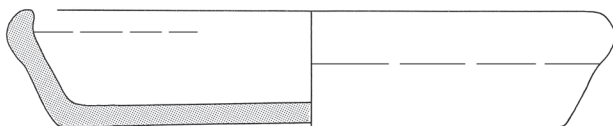

2

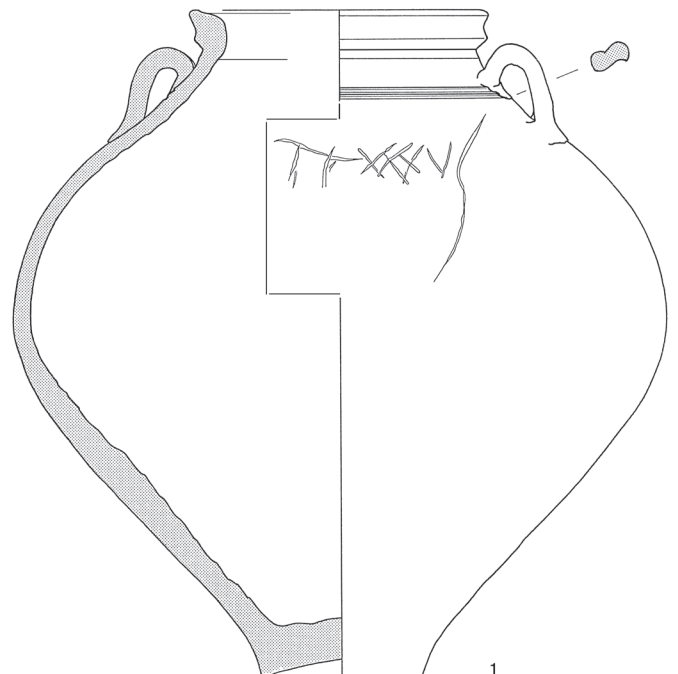

1

Grab 368



Nagel

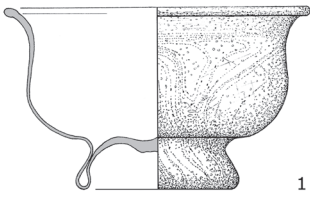

1

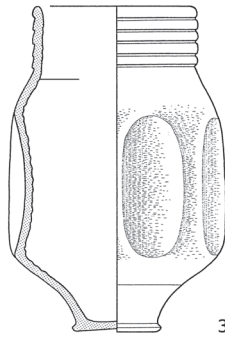

3

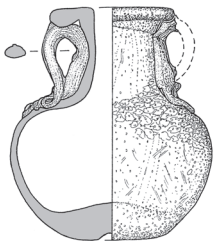

2

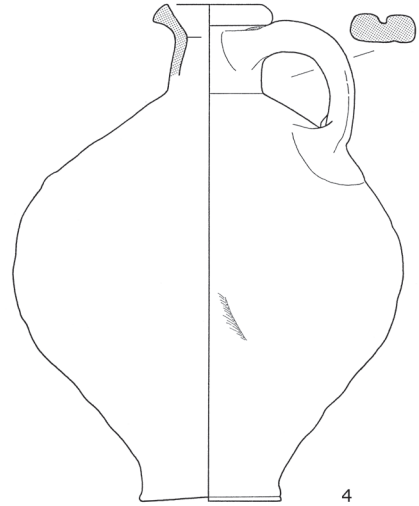

4

Grab 369



Schuhnägel
Glas

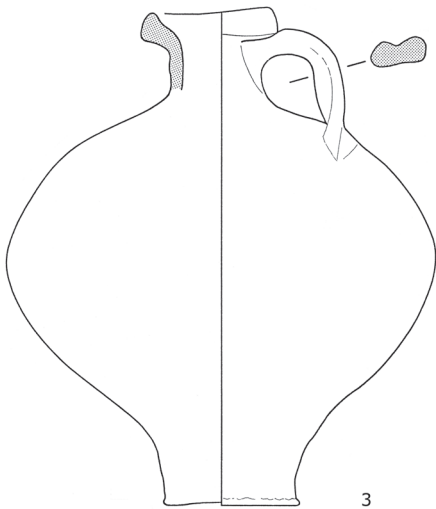

3



4



5



6

Grab 370



Nägel



3



5



4



Grab 371

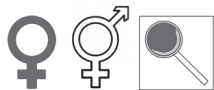

Bronzeblech

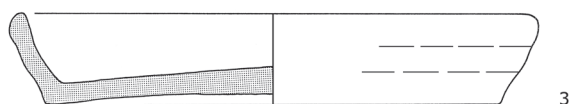

3

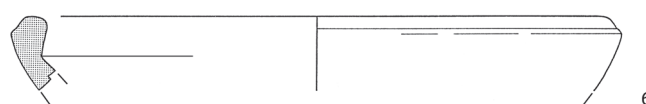

6

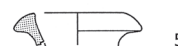

5

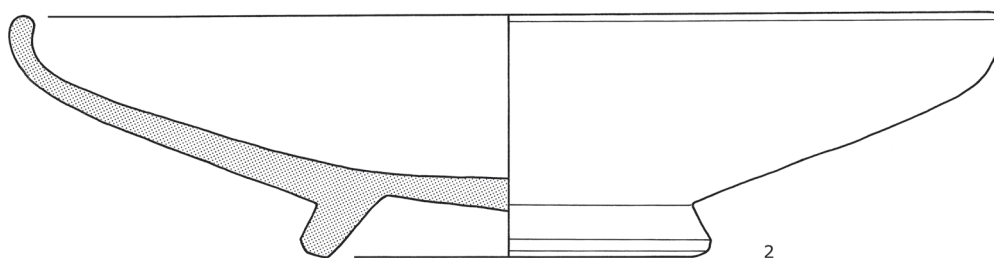

2

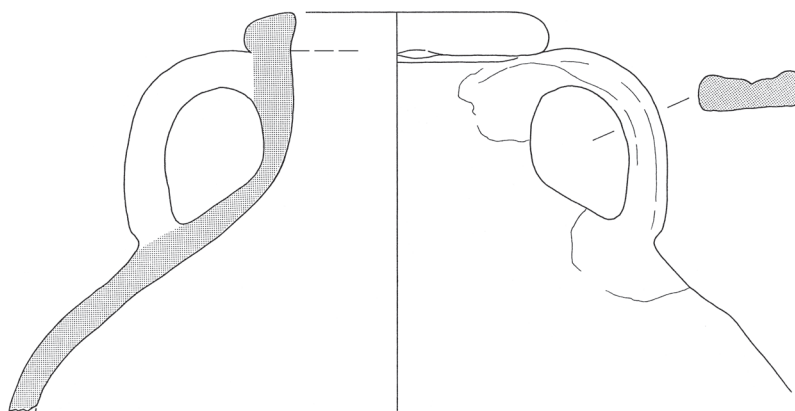

1

Grab 372



Schuhnagel
Nägel

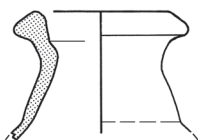

2

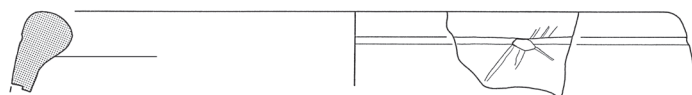

4

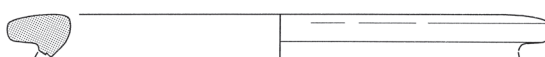

5

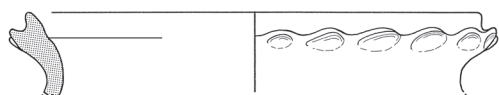

6



7

Fundstelle 373

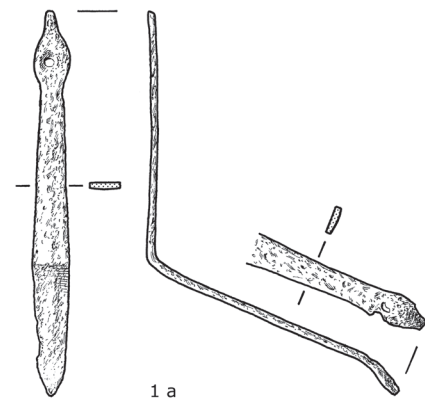

1 a

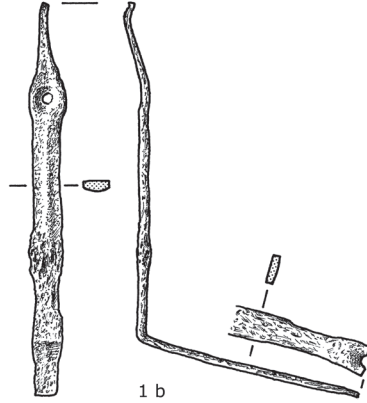

1 b

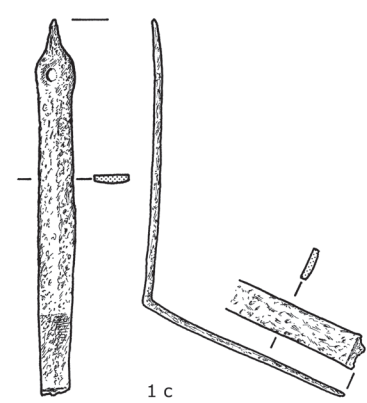

1 c

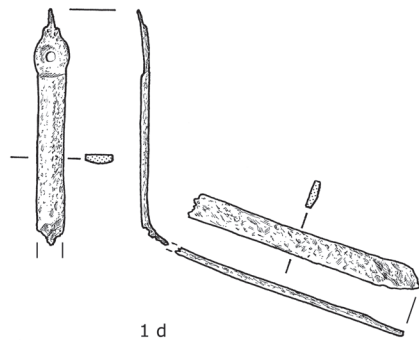

1 d

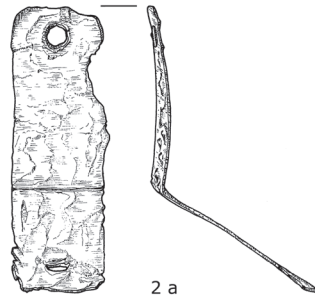

2 a

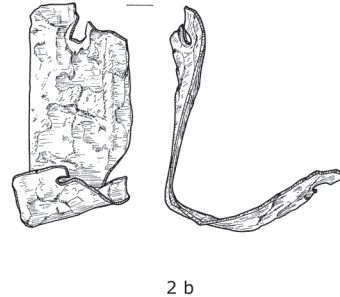

2 b

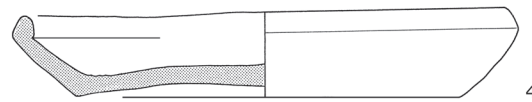

4



5

Grab 374



2

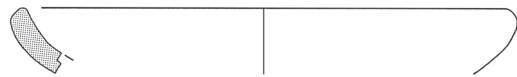

3



4

Grab 375



3

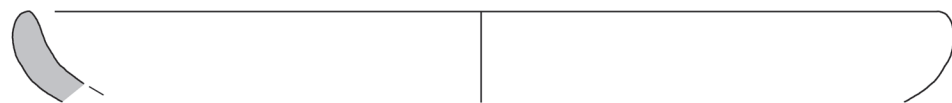

4

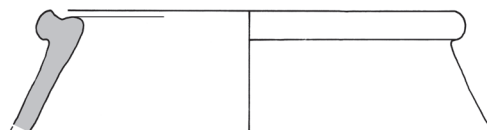

5

Fundstelle 376



Eisen
Ziegel

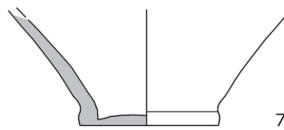
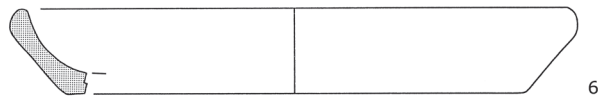
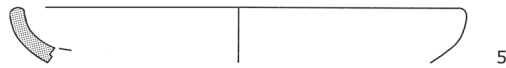
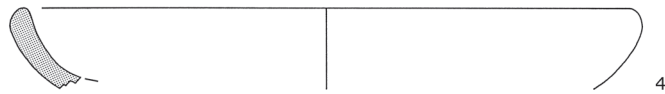
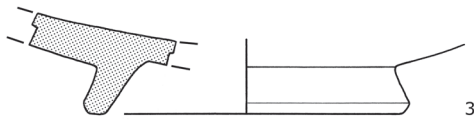
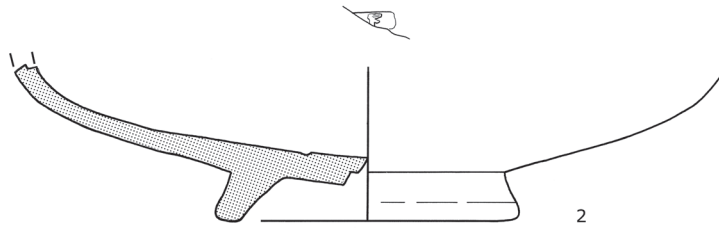

Grab 377



Bronze
Nägel



Grab 378



Nägel

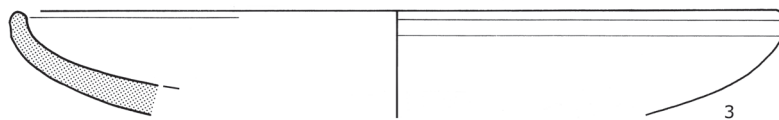

Grab 378

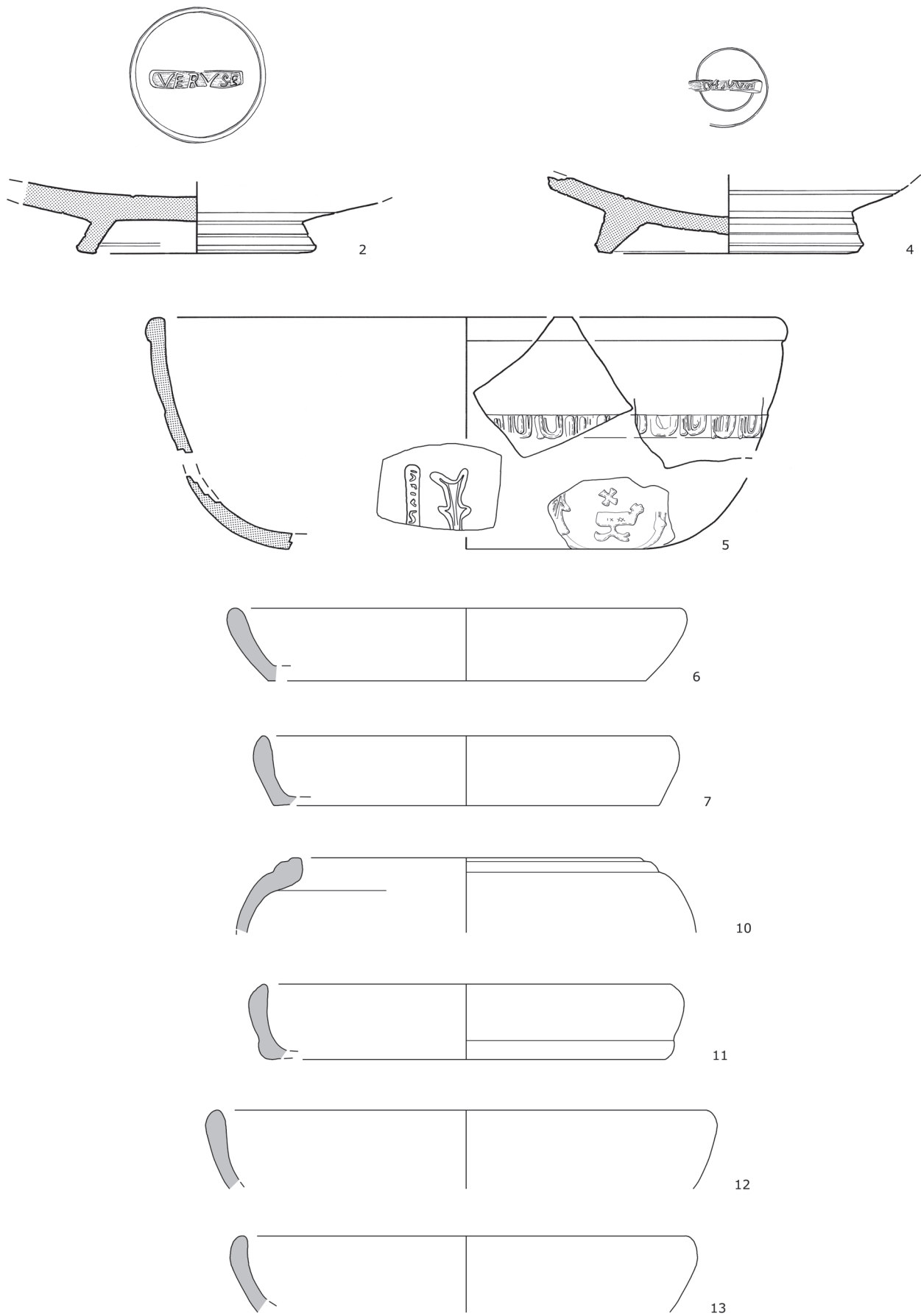

Grab 379



Nagel

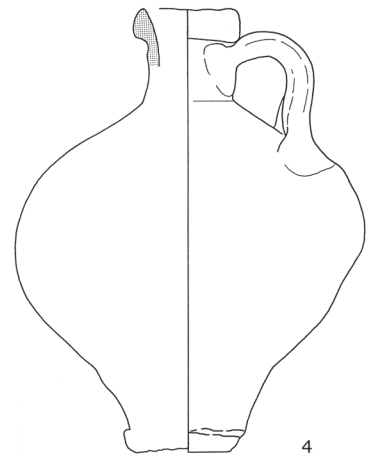
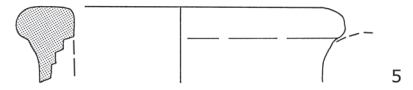
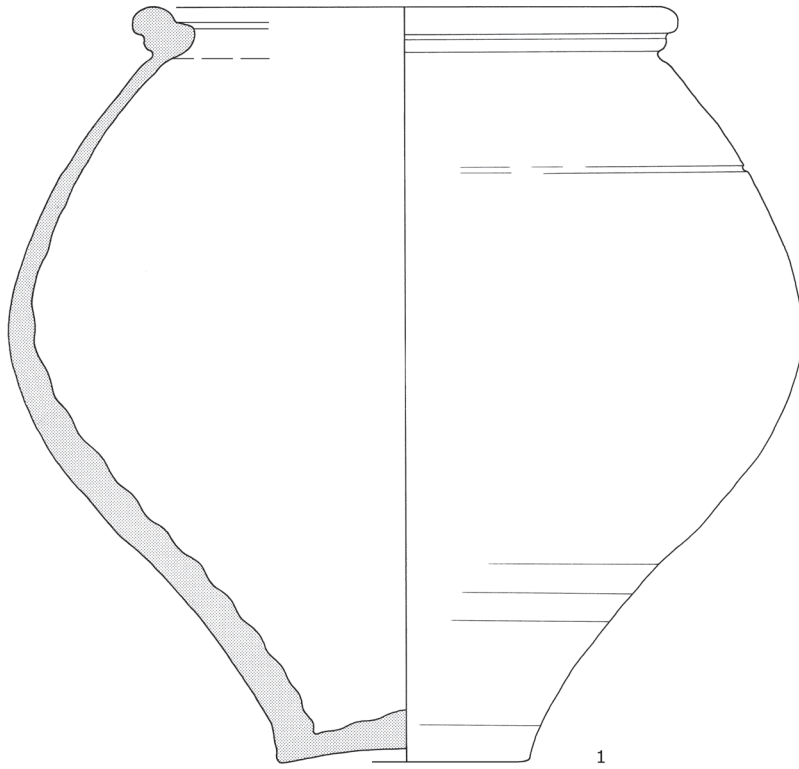

Grab 380



Schuhnägel
Nagel
Ziegel

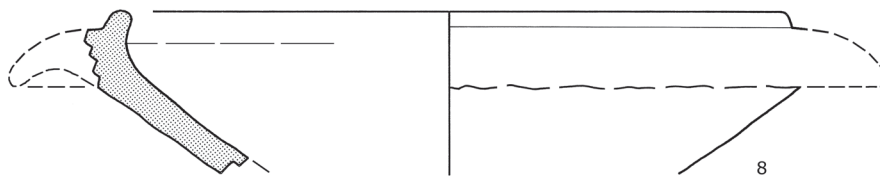
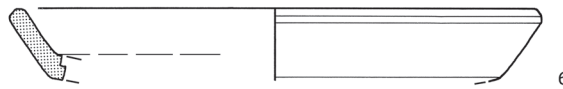
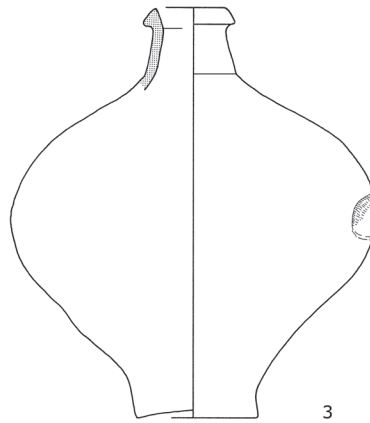
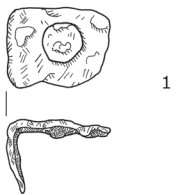

Grab 381



Nägel

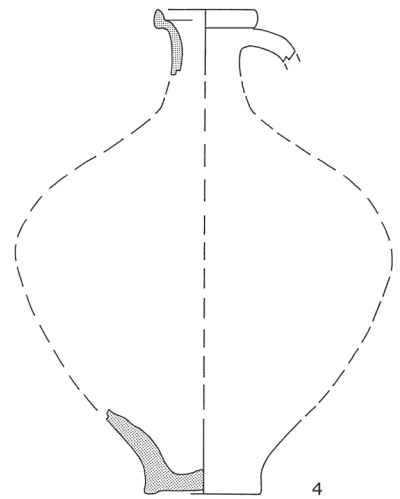
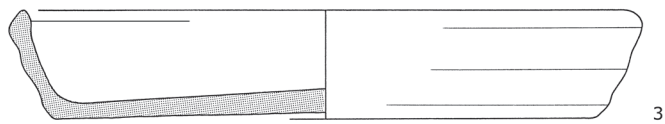
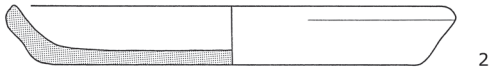
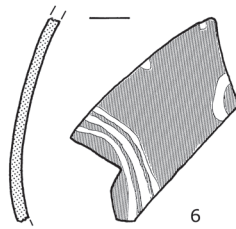
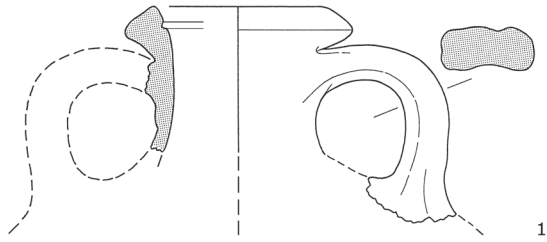

Grab 382



Nagel
Keramik



Grab 383



Nagel

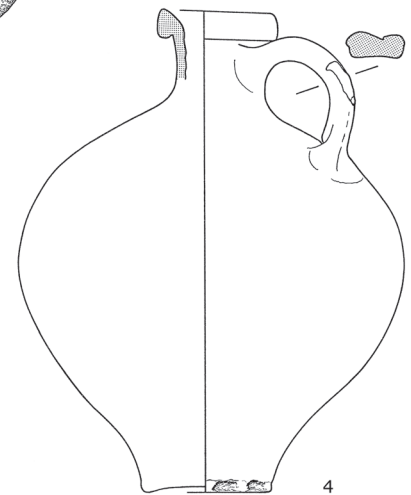
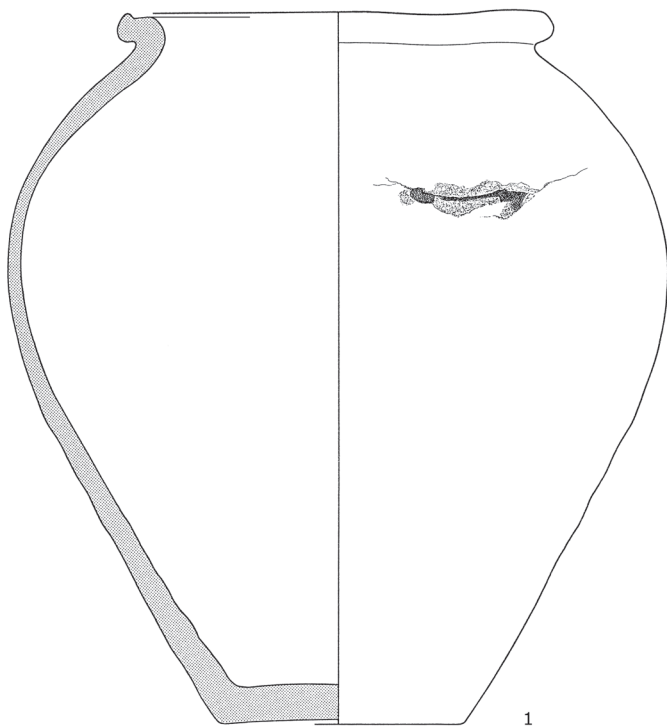
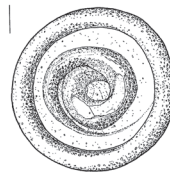
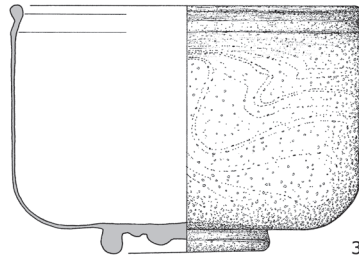

Grab 384



Schuhnägel
Nägel

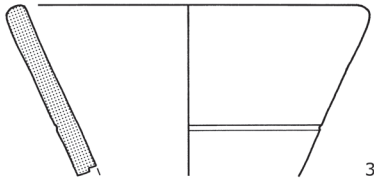

3



4

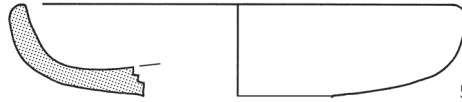

5

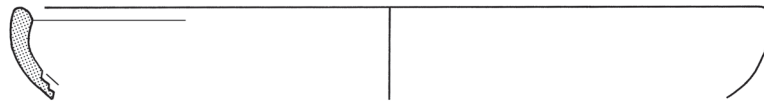

6

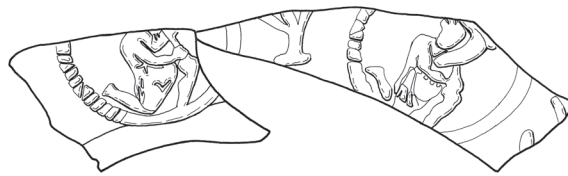

7

Grab 385



Nägel
Keramik

Fundstelle 386



1



2

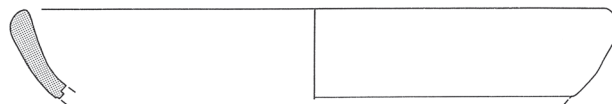

3

Fundstelle 387



3

Fundstelle 387

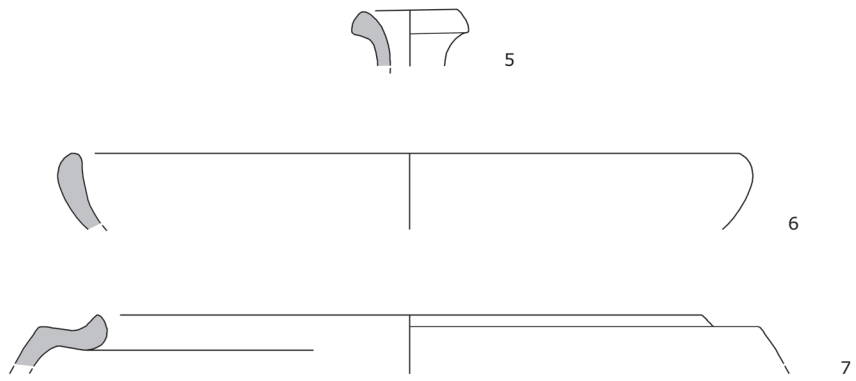

Fundstelle 388

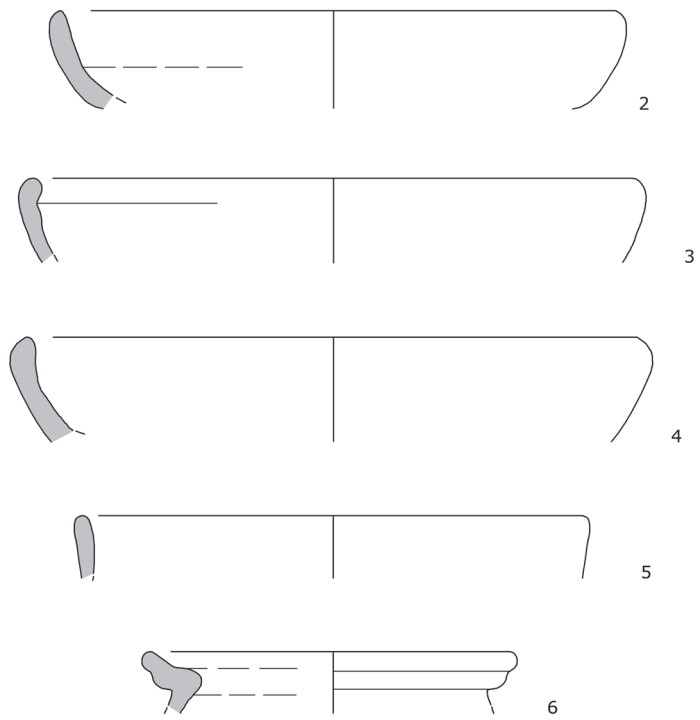

Fundstelle 389

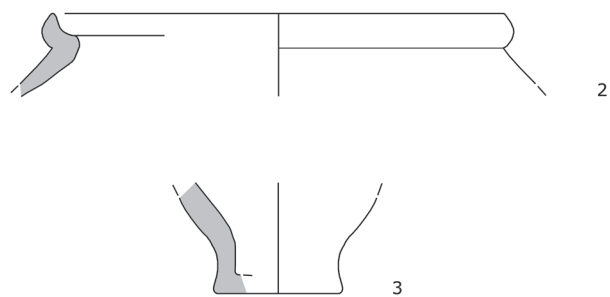

Fundstelle 390

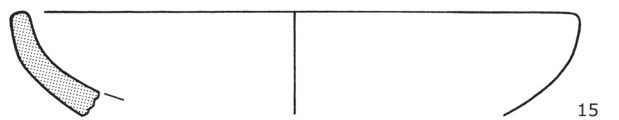
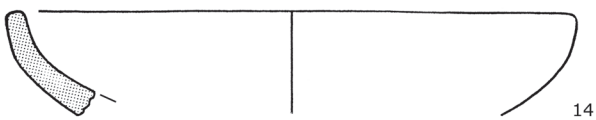
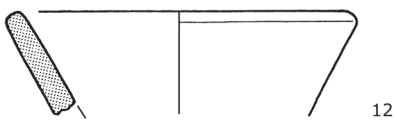
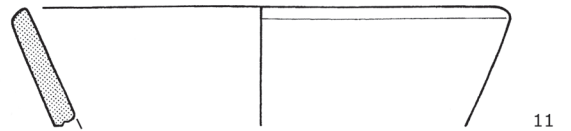
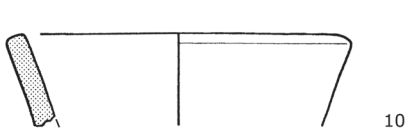
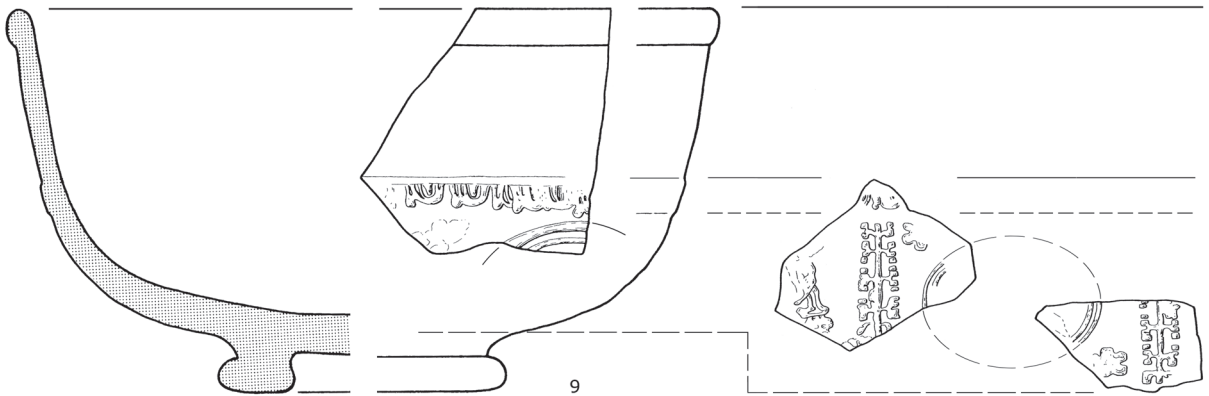
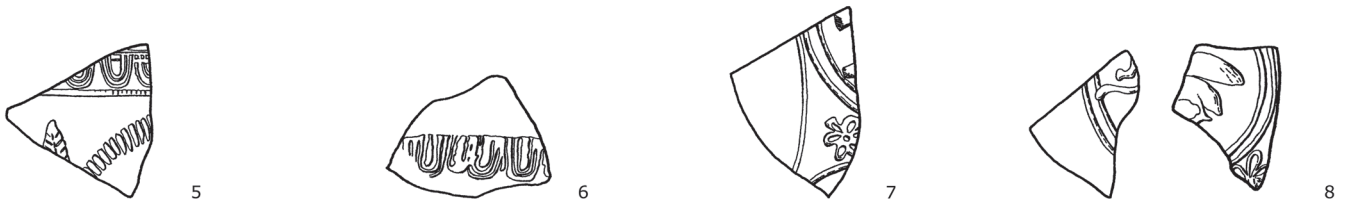
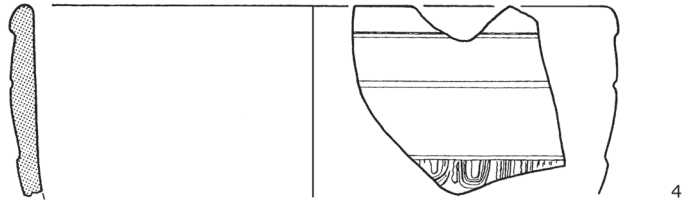
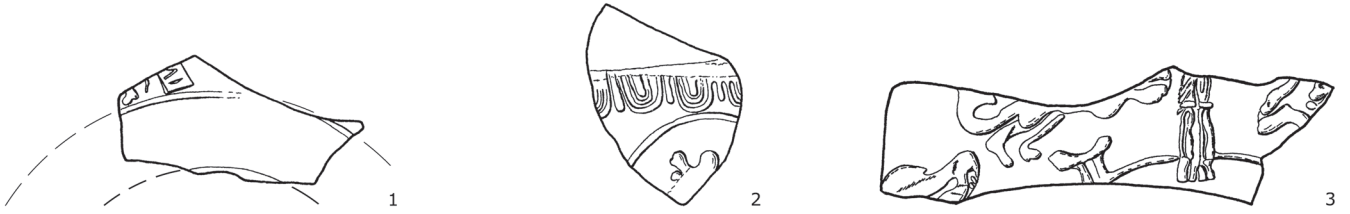

Fundstelle 390

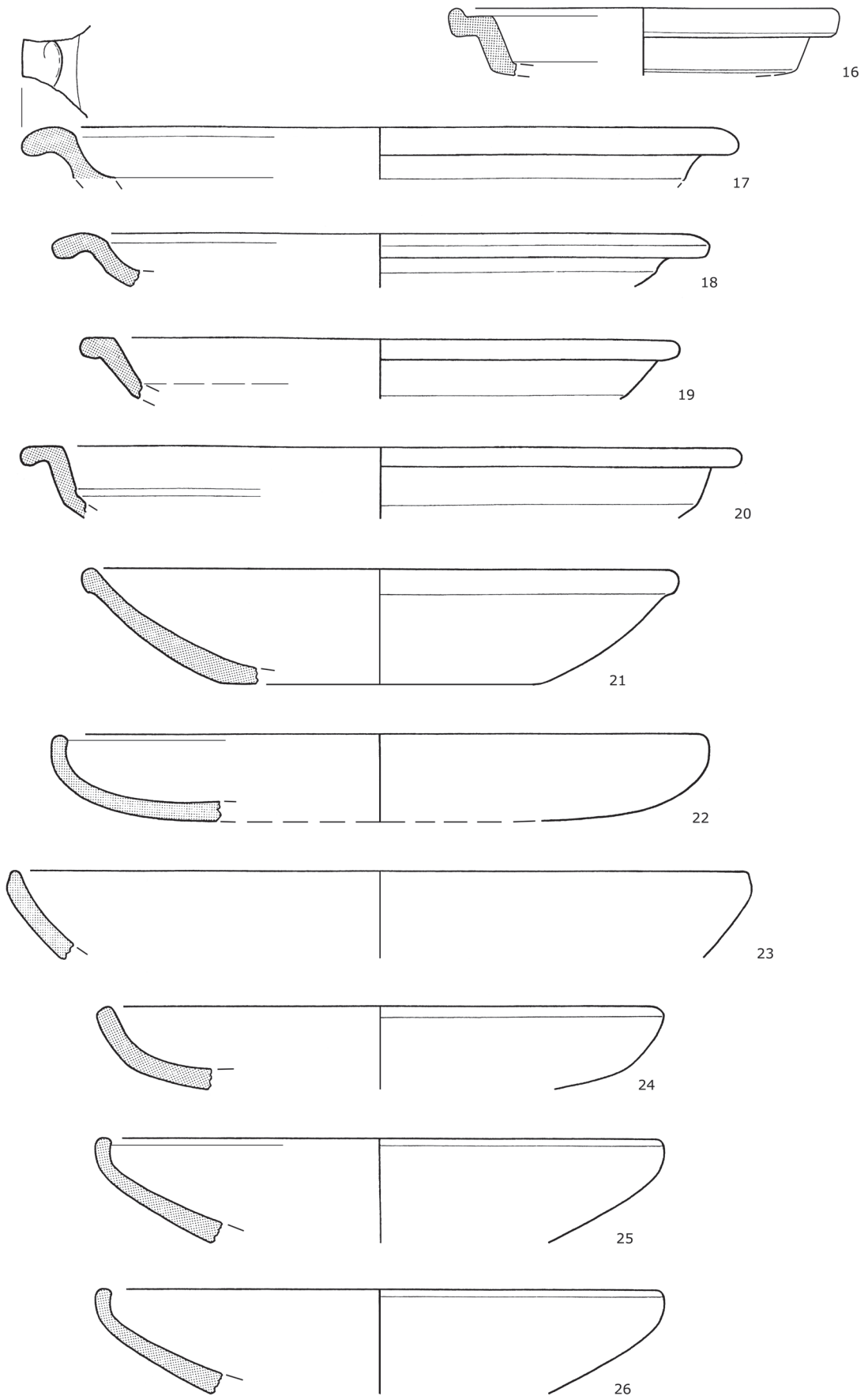

Fundstelle 390

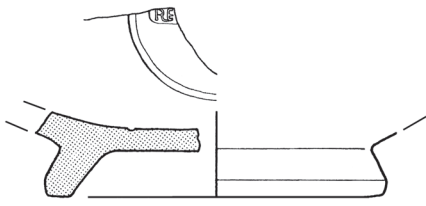

*MΠIOA

28

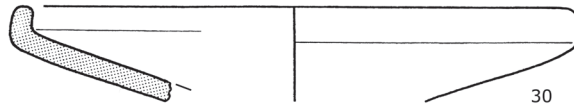
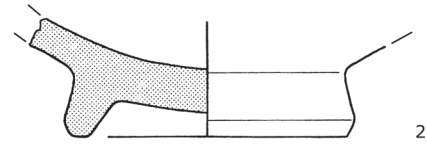

CAVXXV

31

DOMITVSE

32

FLORENT

33

MAIRCE

34

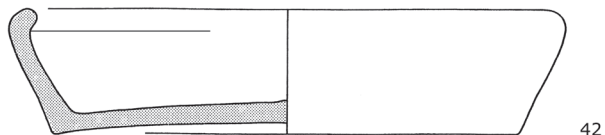
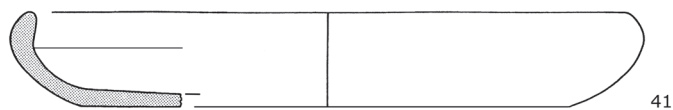
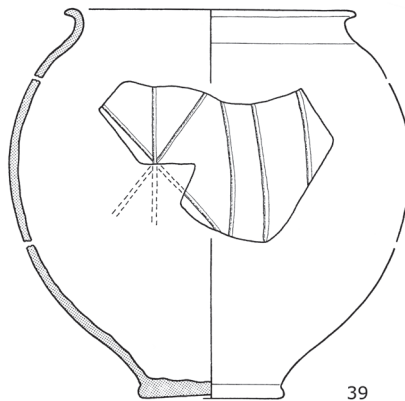
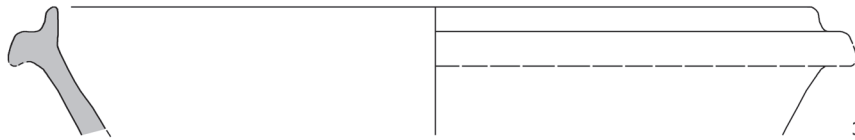
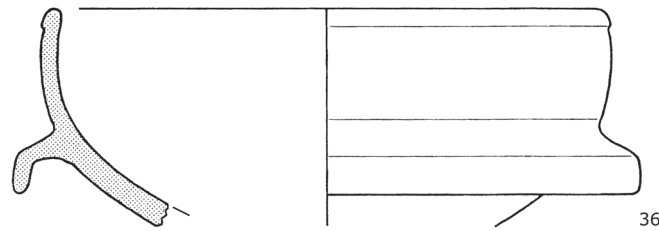
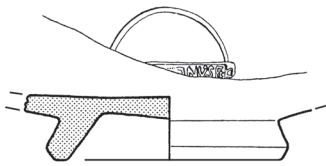

←←
Fundstelle 390

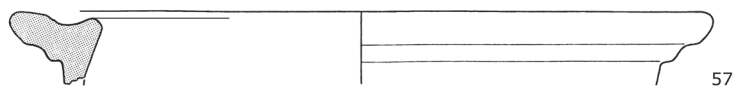
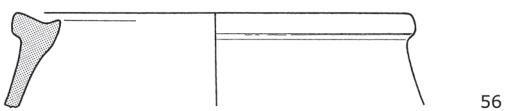
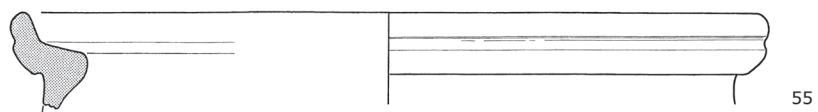
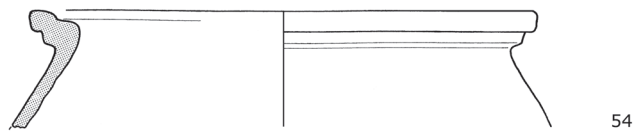
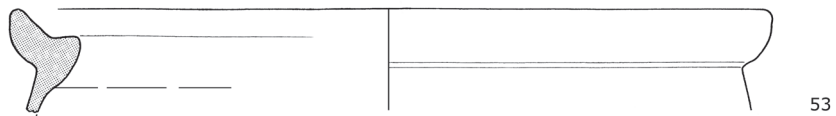
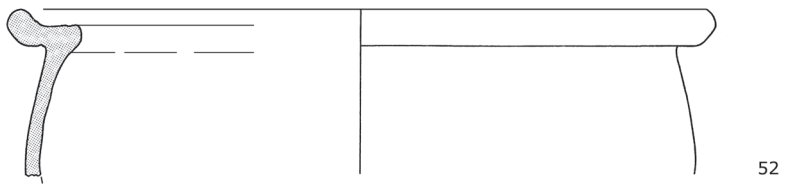
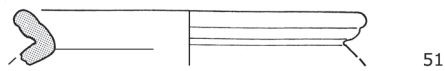
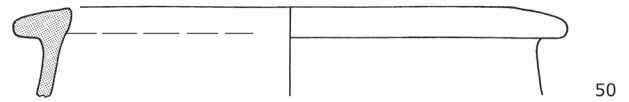
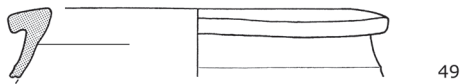
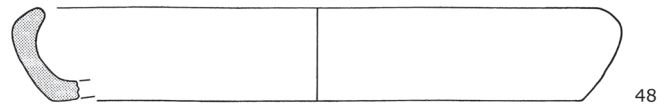
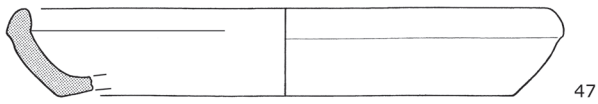
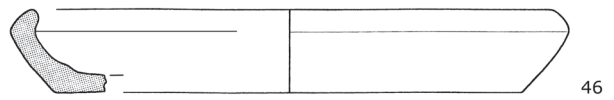
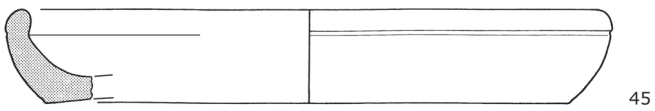
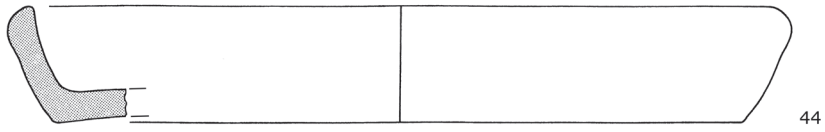
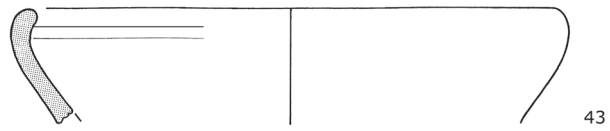

Fundstelle 390

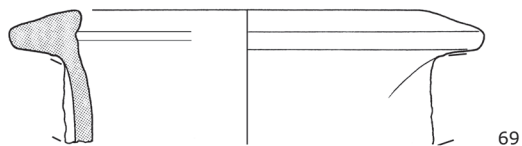
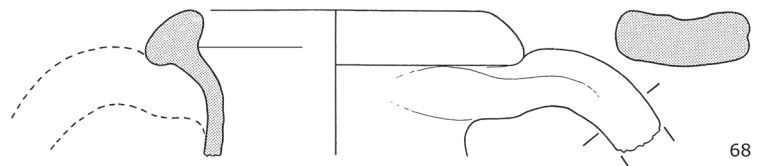
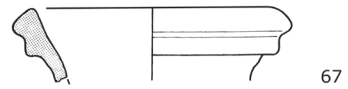
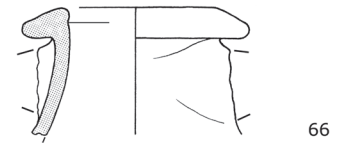
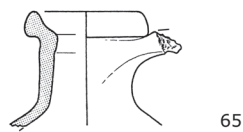
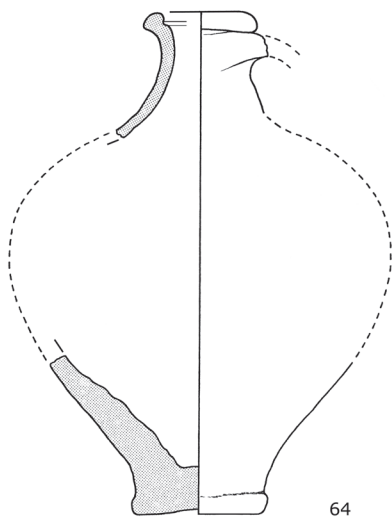
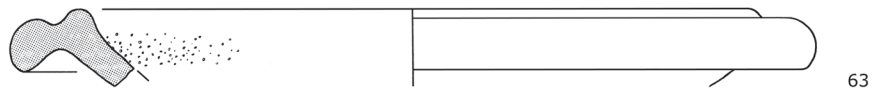
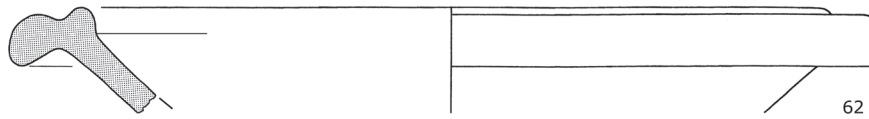
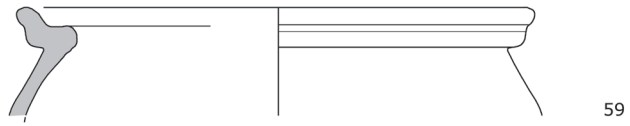
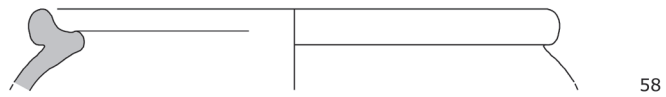

Übersicht Stempel 1 - 28



1



2



3



4



5



6



7



8



9



10



11



12



13



14



15



16



17



18



19



20



21



22



23



24



25

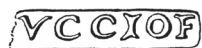

26



27



28

Übersicht Stempel 29 - 55



29



30



31



32



33



34



35



36

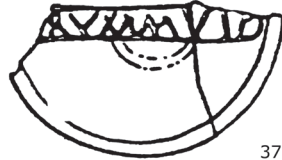

37



38



39



40



41



42



43



44



45



46



47

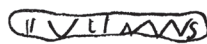

48



49



50



51



52



53



54



55

Übersicht Stempel 56 - 76

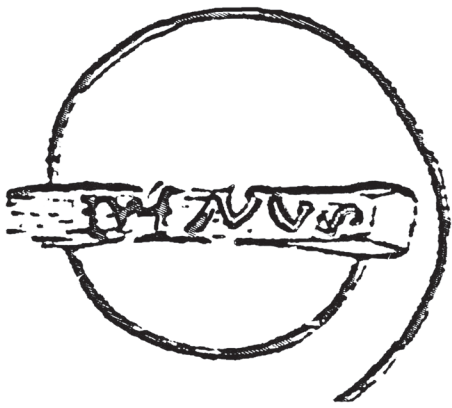

56



57



58



59



60



61



62



63



64



65



66



67



68



69



70



71



72



73



74



75







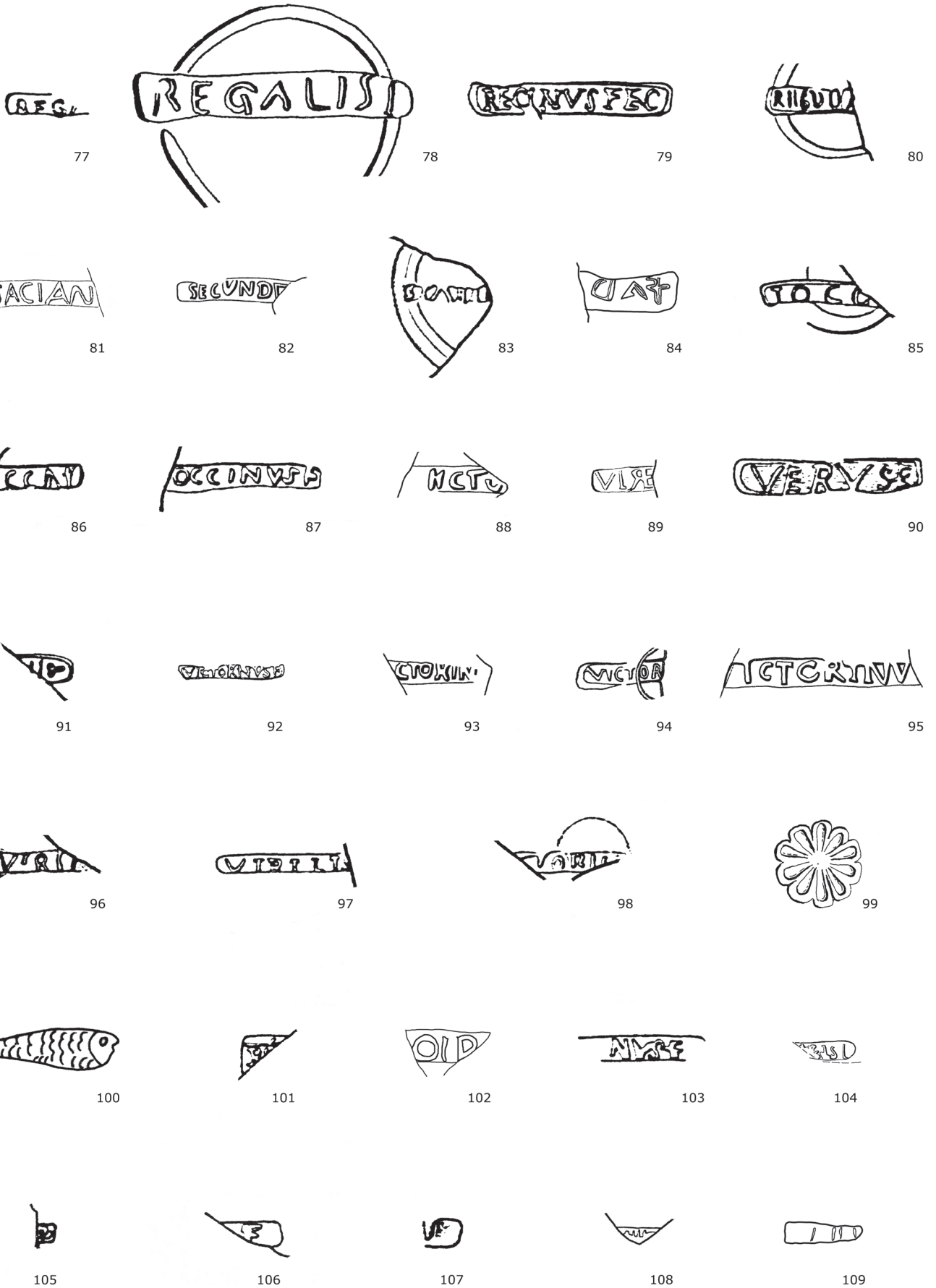











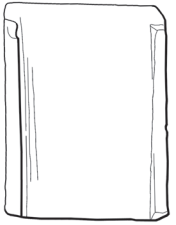

76



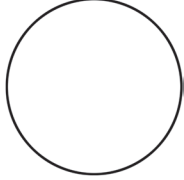

































Übersicht Stempel 77 - 109



Legende Tafeln

			Geschlecht weiblich, männlich, unbestimmt verbrannt		Tierknochen unbestimmt verbrannt	
			Geschlecht weiblich, männlich, unbestimmt unverbrannt		Tierknochen unbestimmt unverbrannt	
	noch ausstehende anthropologische/ osteologische Untersuchungen				Ansprache nicht sicher	
	Steinkistengrab					
	Ziegelplattengrab	Tegula/ Bruchstücke		Imbrex/ Bruchstücke		Münze
	Tierbestattung					
	nicht beziffertes, nicht gezeichnetes Grabinventar					
	Bezugspfeile für tafelübergreifendes Grabinventar, oberhalb: Verweis auf Vorgängertafel/n unterhalb: Verweis auf Folgetafel					

Osteologie: verbrannt, unverbrannt

		Rind			Hund			Gans
		Pferd			Hirsch			Huhn
		Schwein			Feldhase			Ei/ Eierschale
		Schaf/ Ziege unbestimmt			Singvogel			Vogel, unbestimmt
		Schaf			Kröte			Fisch
		Ziege						Muschel
		Stallhase/ Kaninchen						Schildkröte