

Tafel:1
 Maßstab: 1:3
 Komplex:1

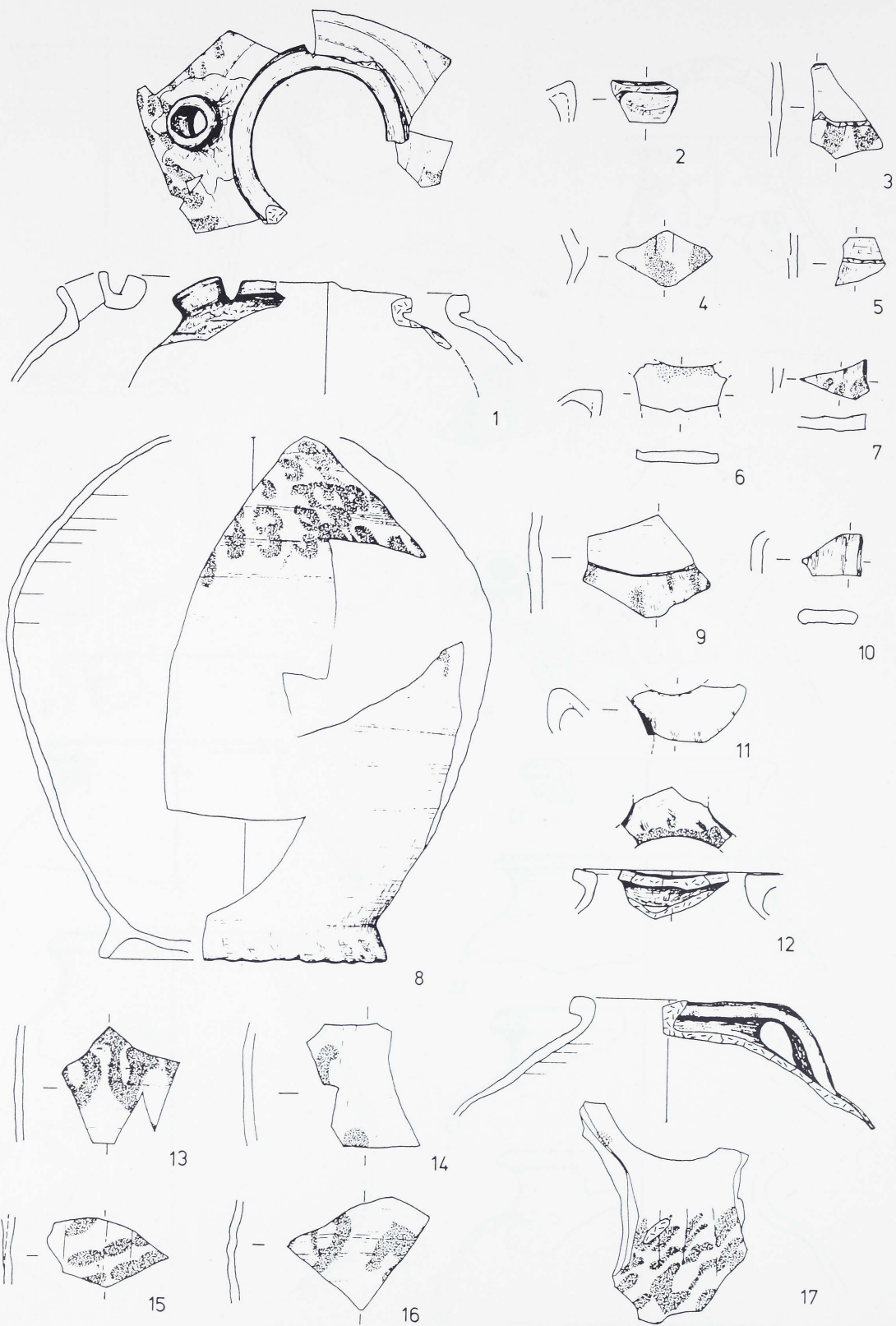

Tafel: 2
 Maßstab: 1:3
 Komplex: 2

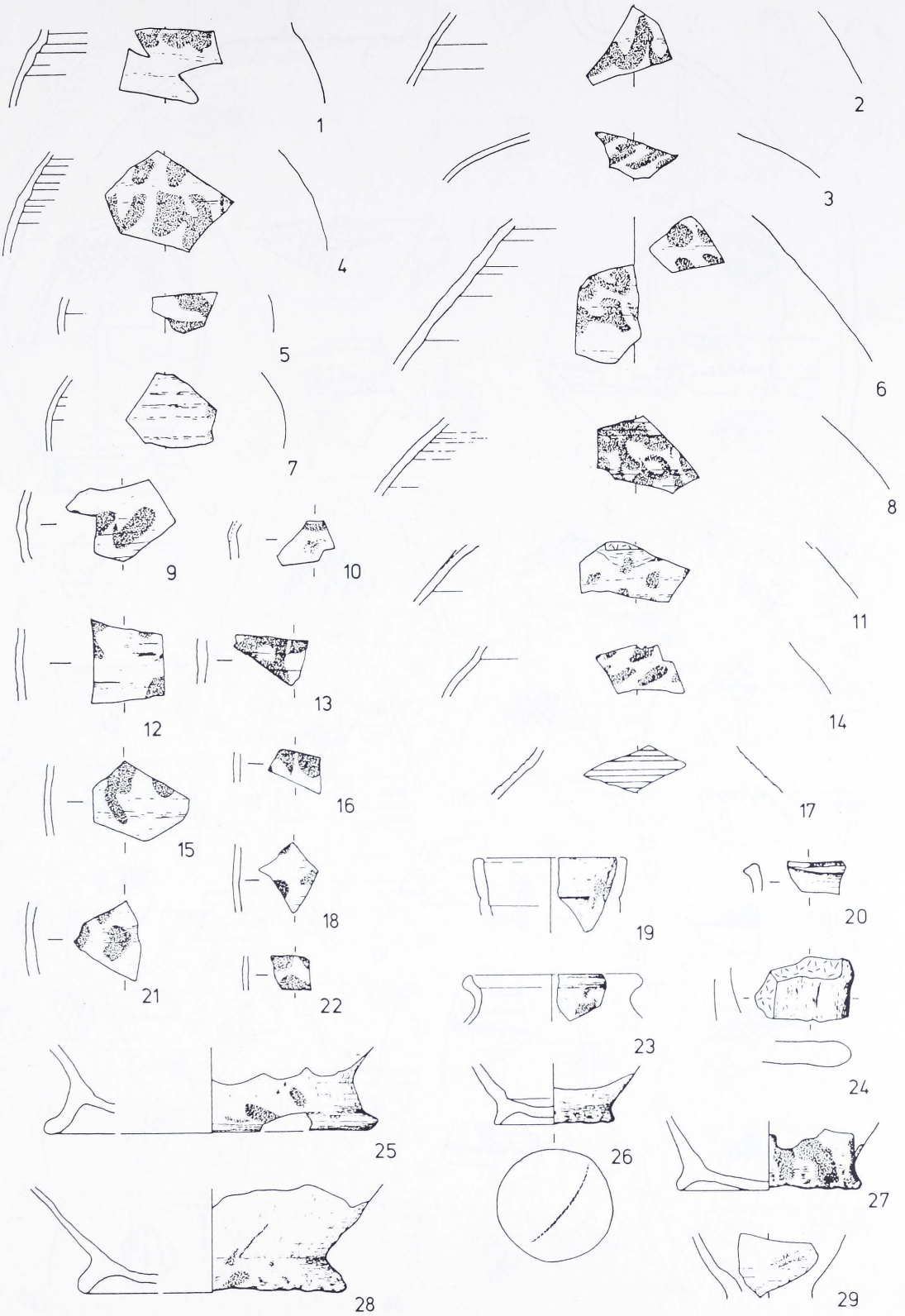

Tafel: 3
 Maßstab: 1:3
 Komplex: 2

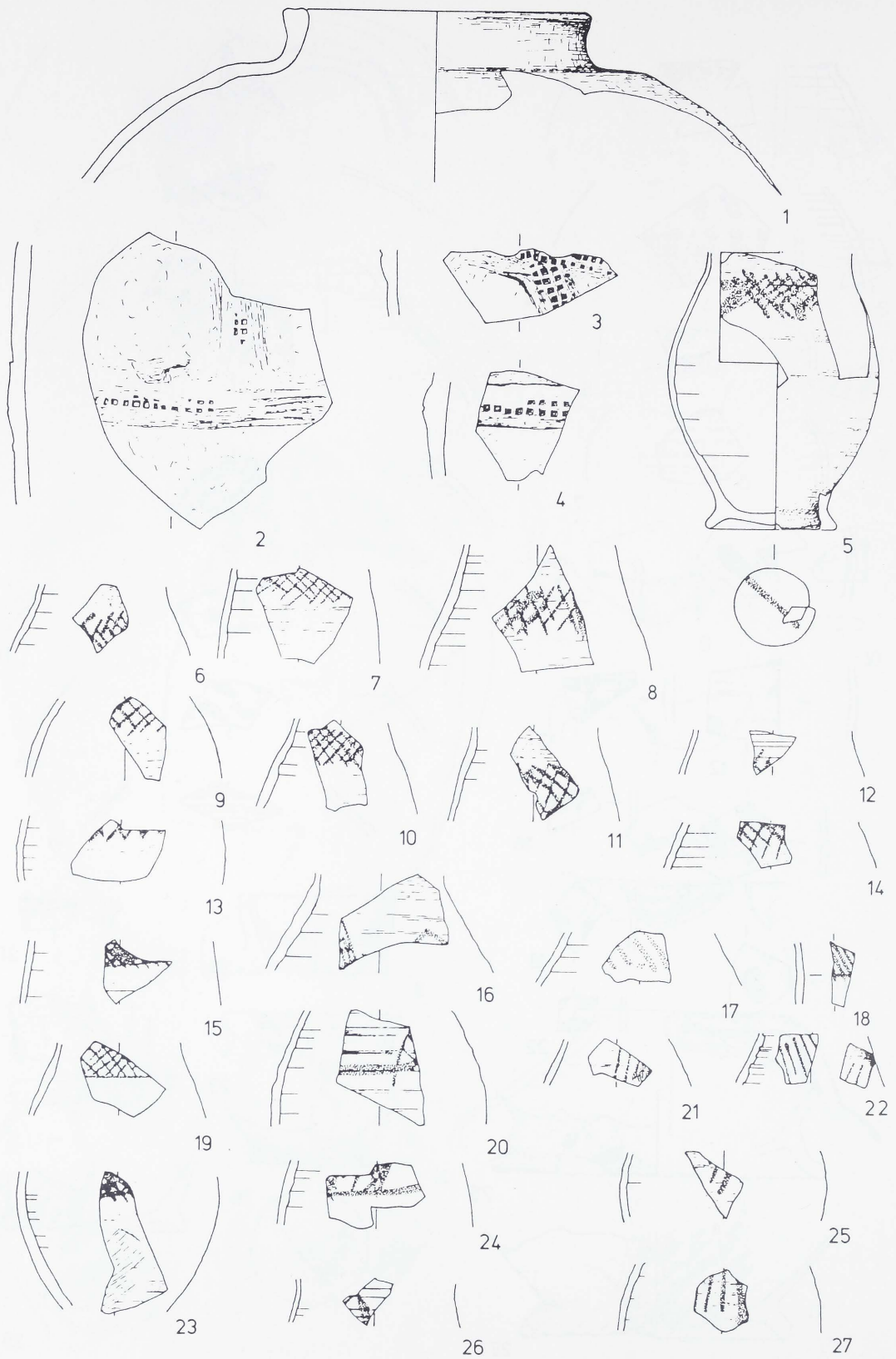

Tafel: 4
 Maßstab: 1:3
 Komplex: 2

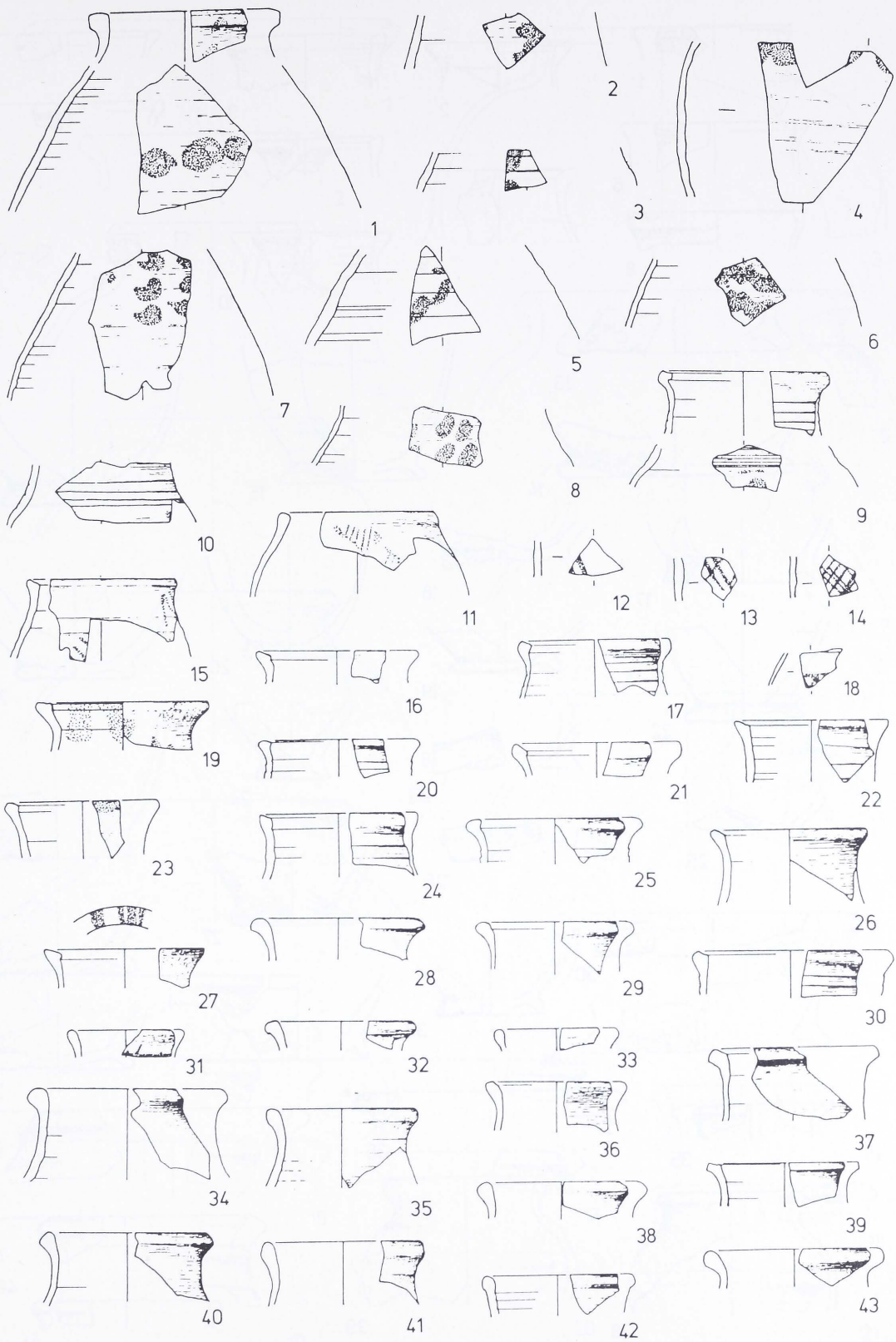

Tafel: 5
 Maßstab: 1:3
 Komplex: 2

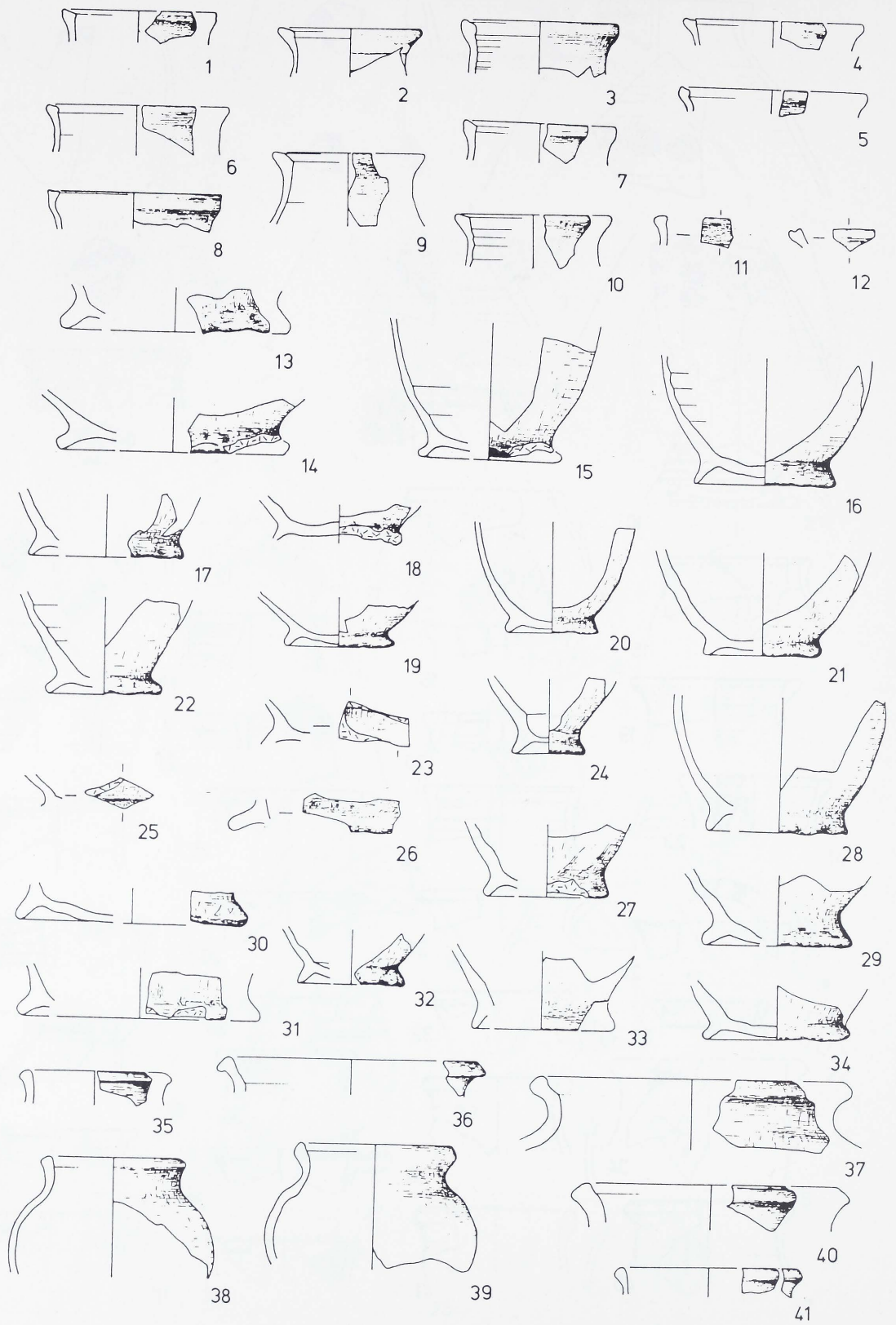

Tafel: 6
 Maßstab: 1:3
 Komplex: 2

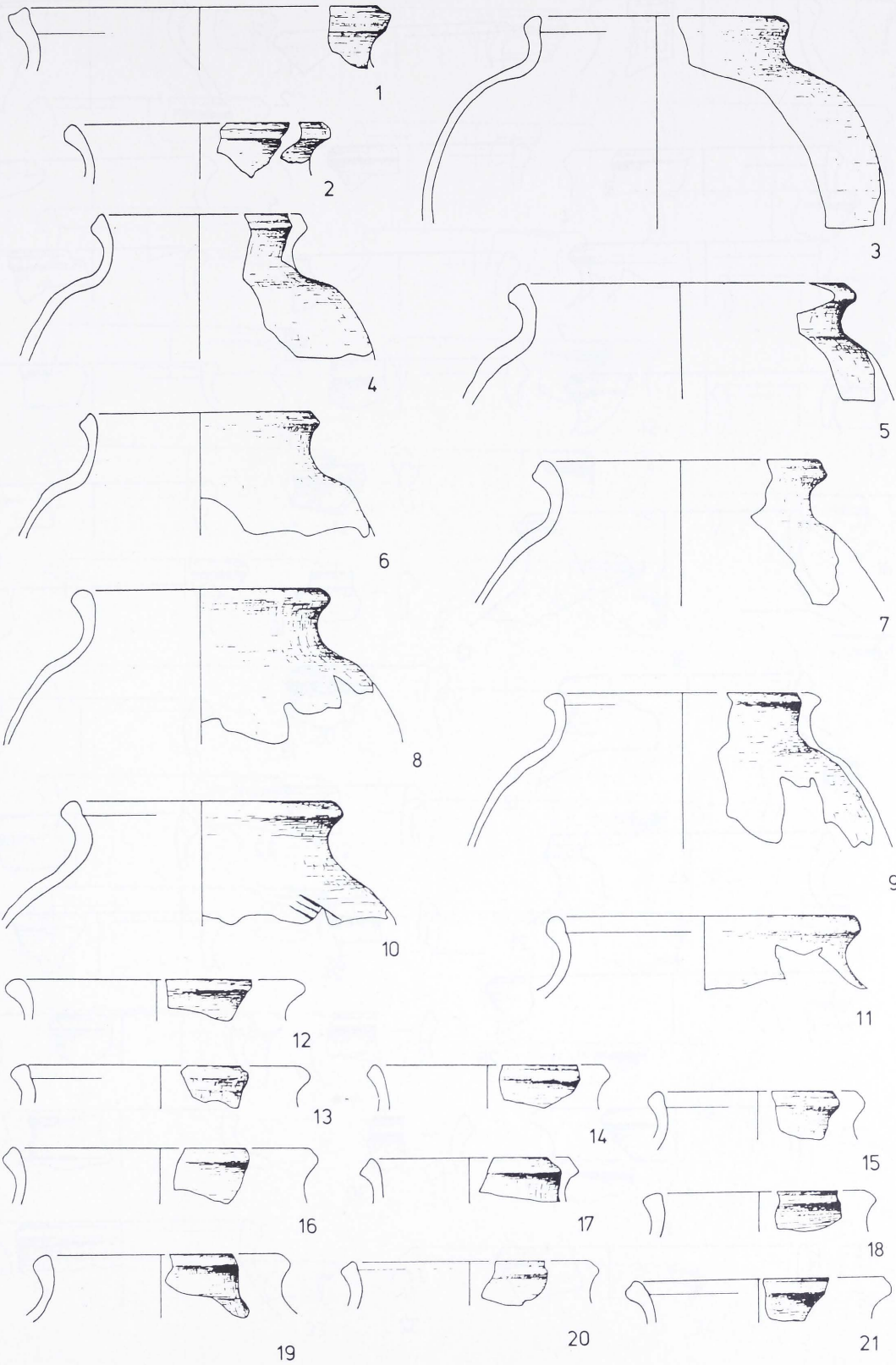

Tafel: 7
 Maßstab: 1:3
 Komplex: 2

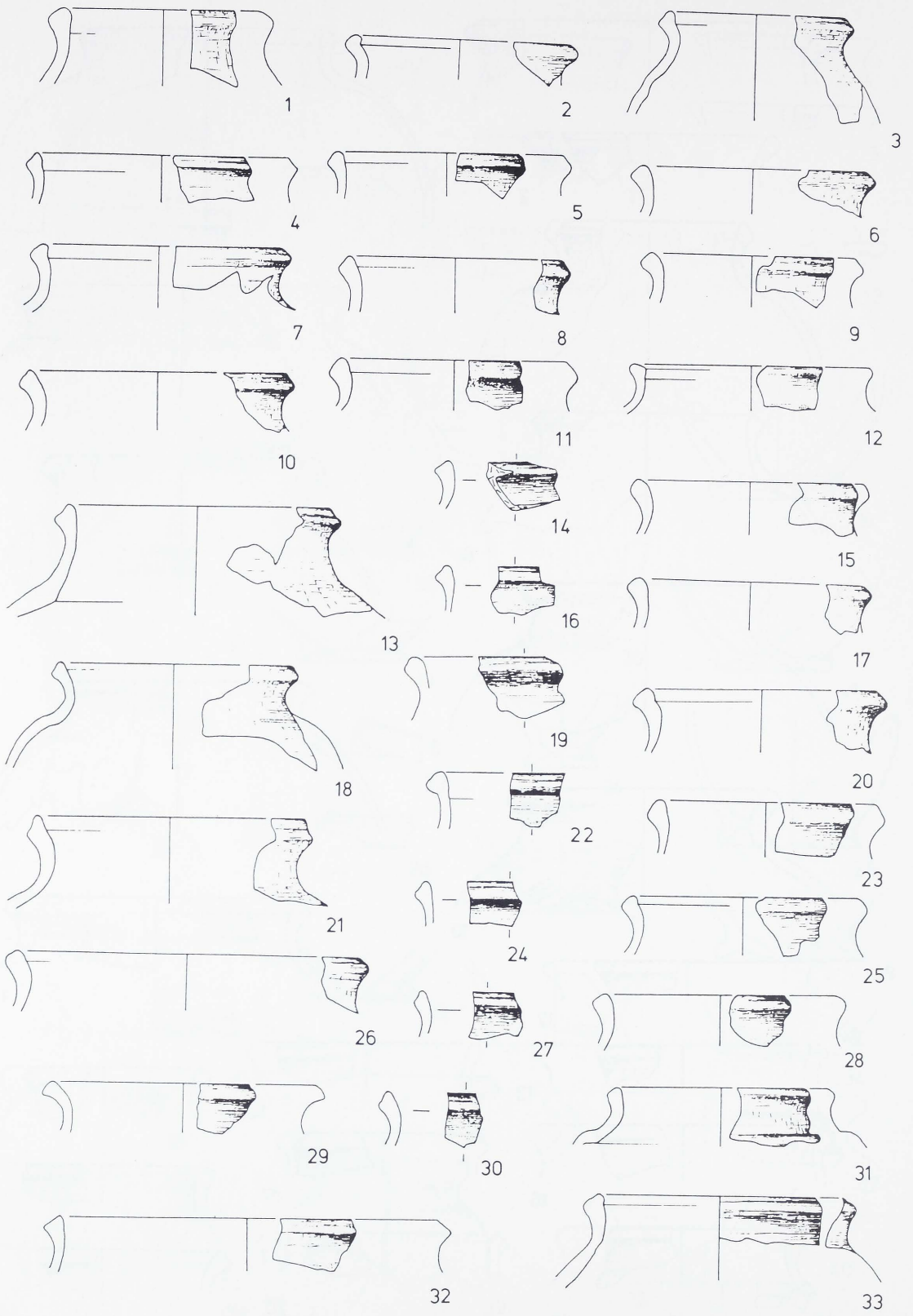

Tafel: 8
 Maßstab: 1:3
 Komplex: 2

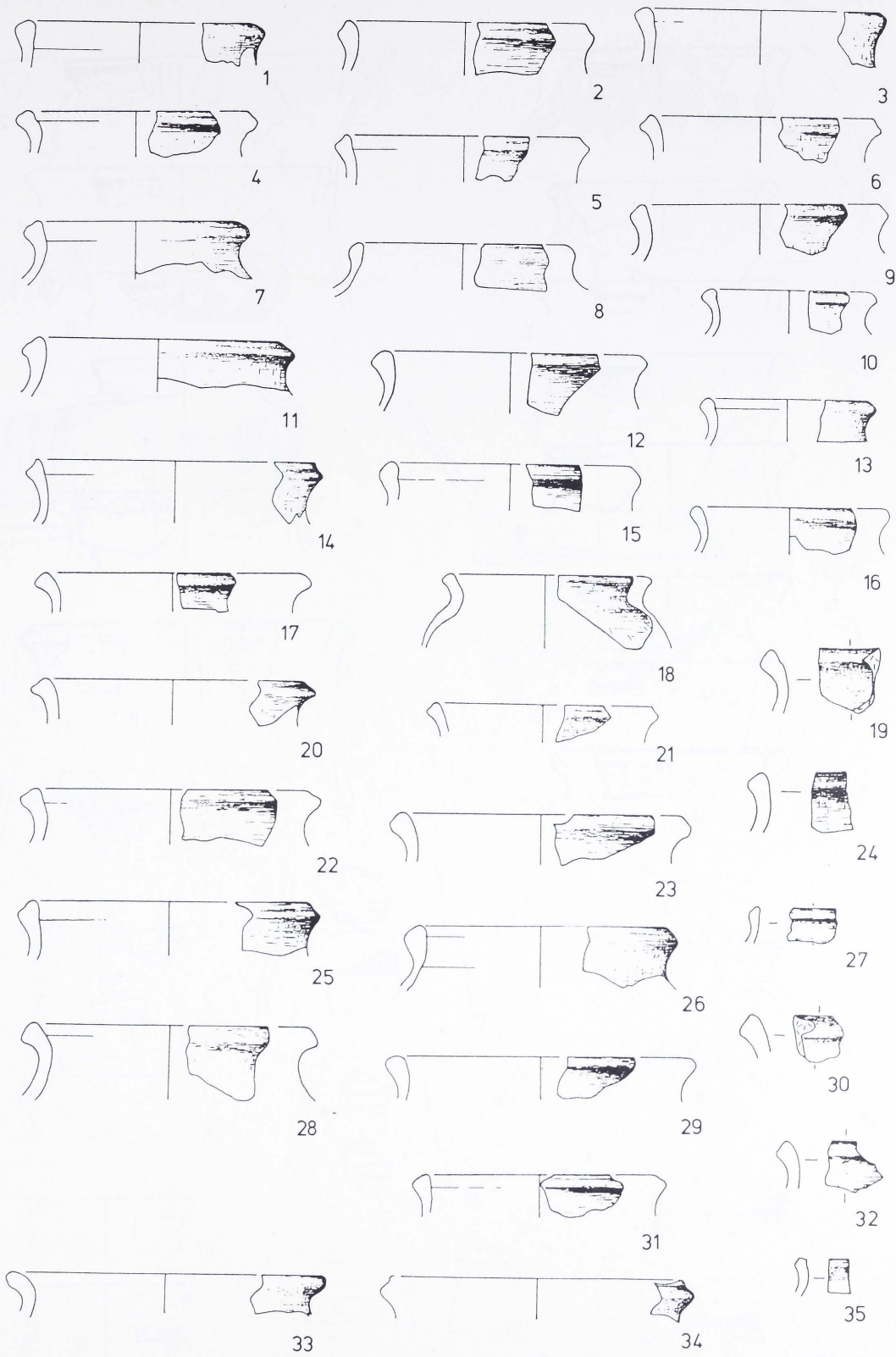

Tafel: 9
 Maßstab: 1:3
 Komplex: 2

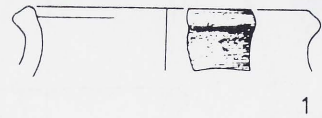

1



2

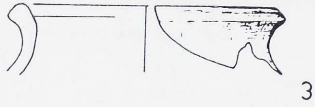

3

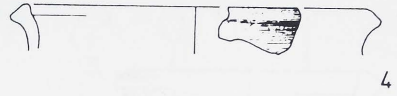

4

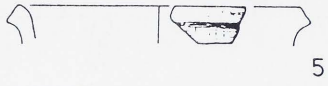

5



6



7



8

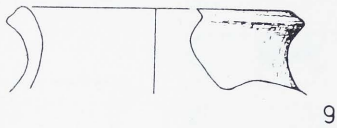

9



10



11



12



13



14

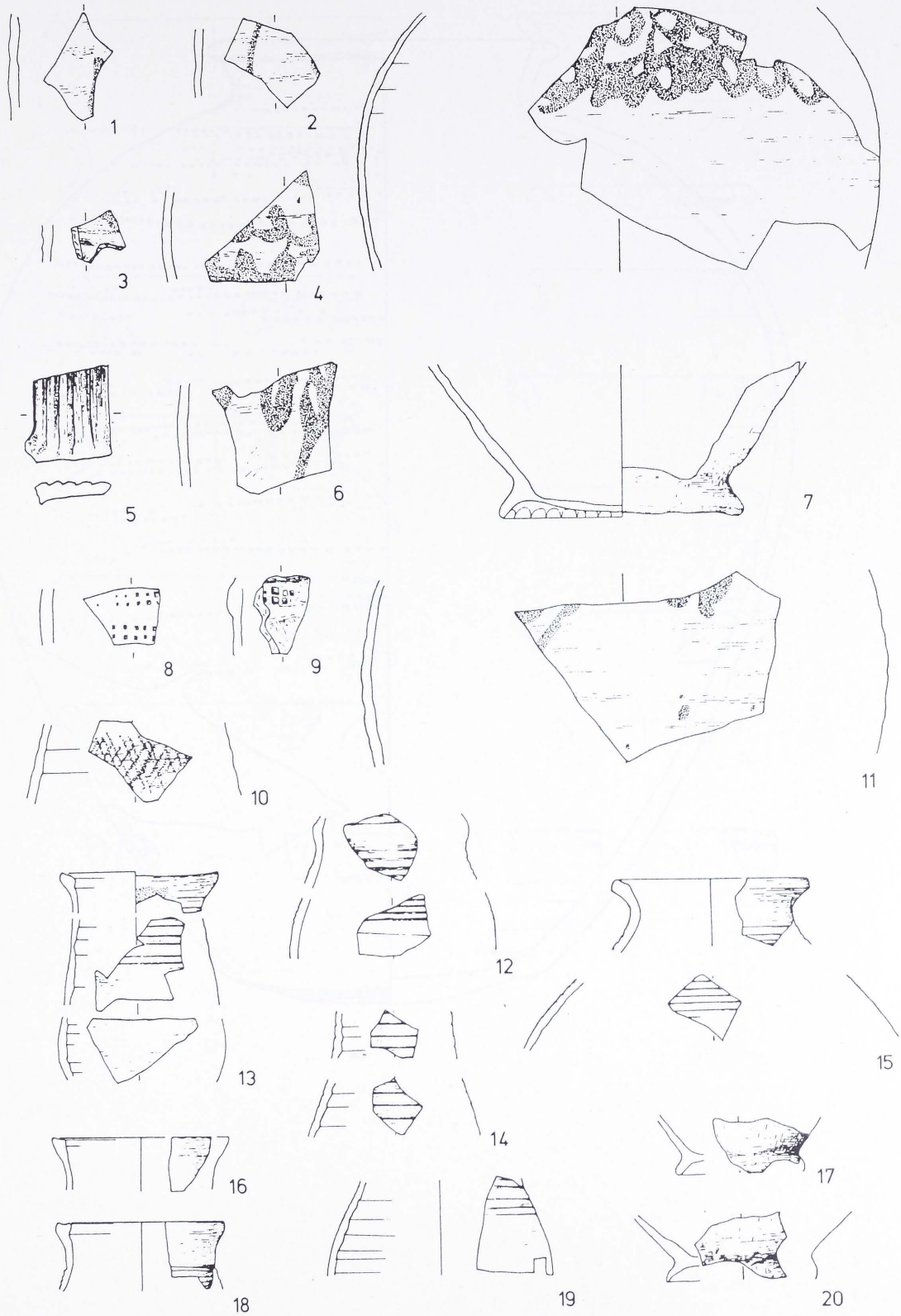

Tafel: 11
 Maßstab: 1:3
 Komplex: 3

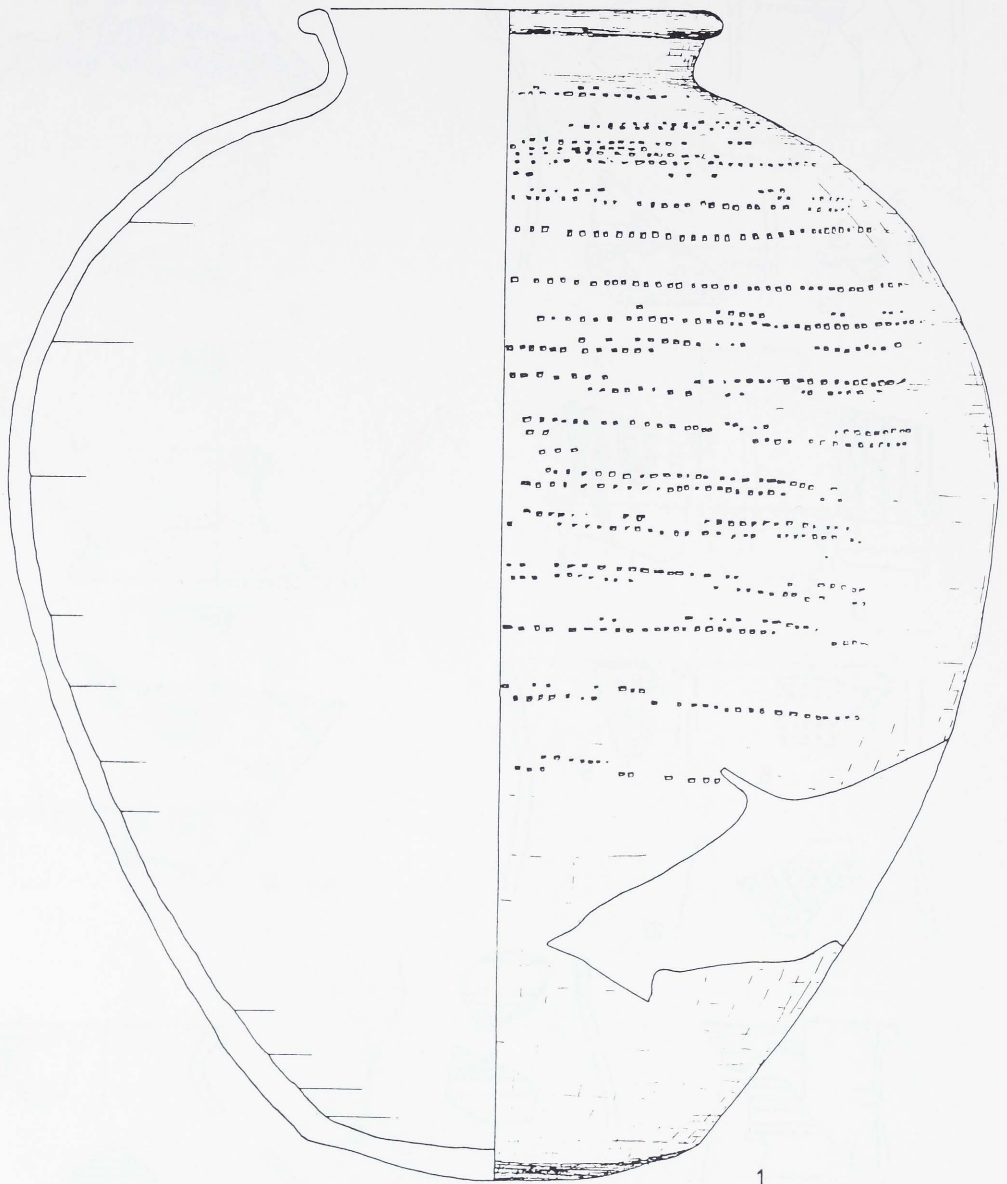

Tafel: 12
Maßstab: 1:3
Komplex: 3

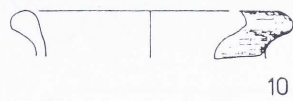
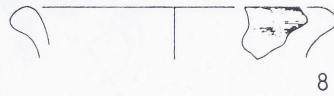
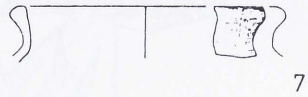
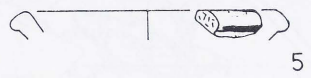
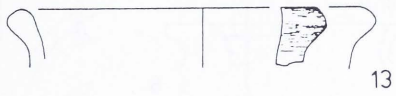
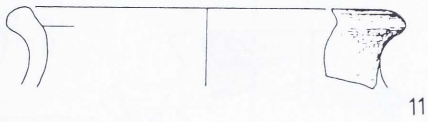
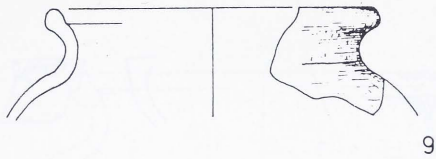
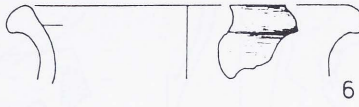
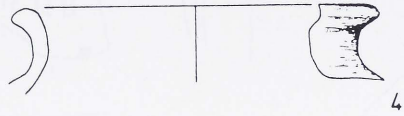
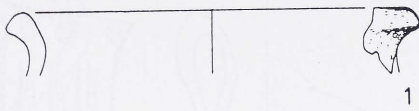

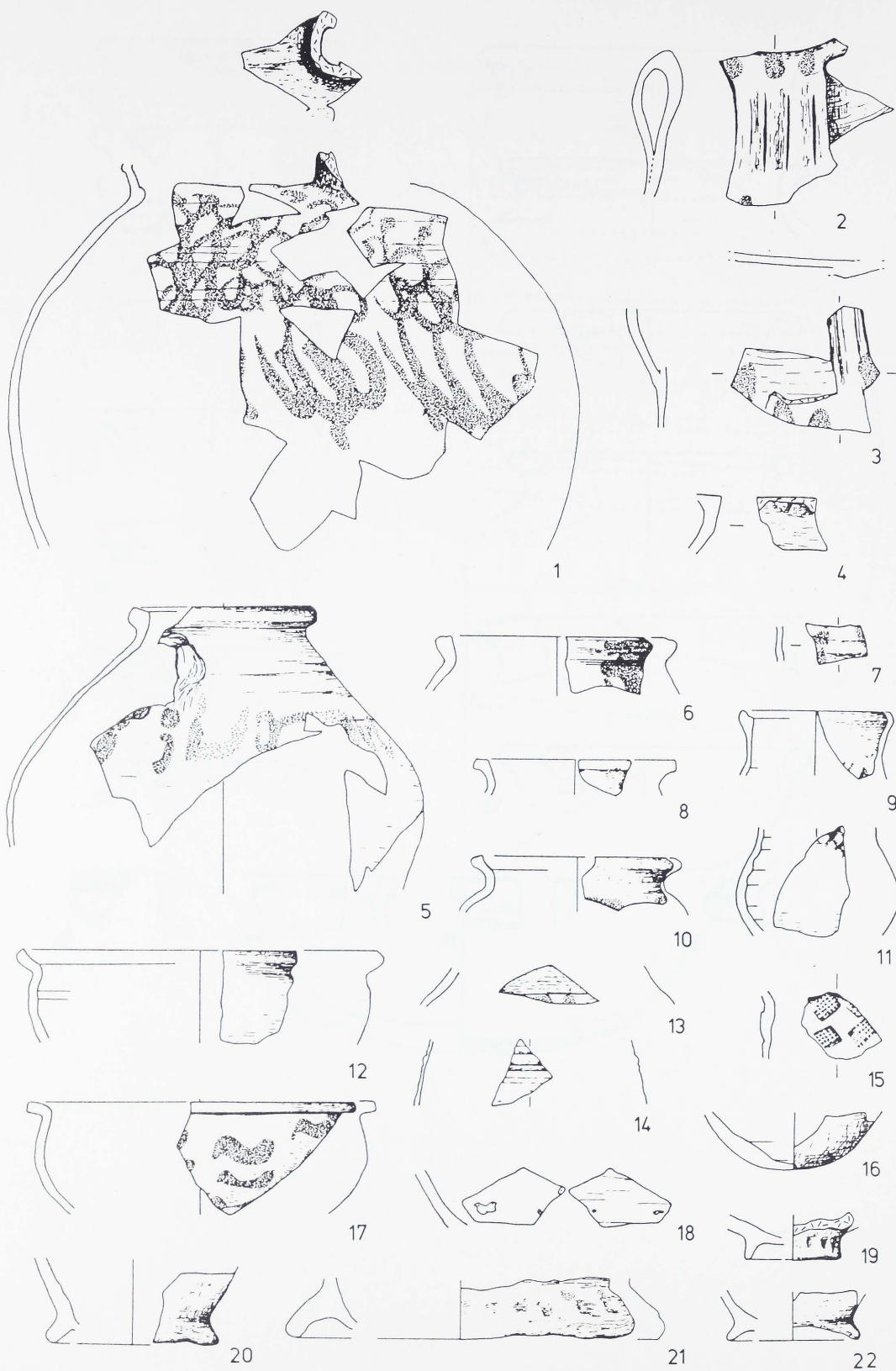

Tafel: 14
 Maßstab: 1:3
 Komplex: 4

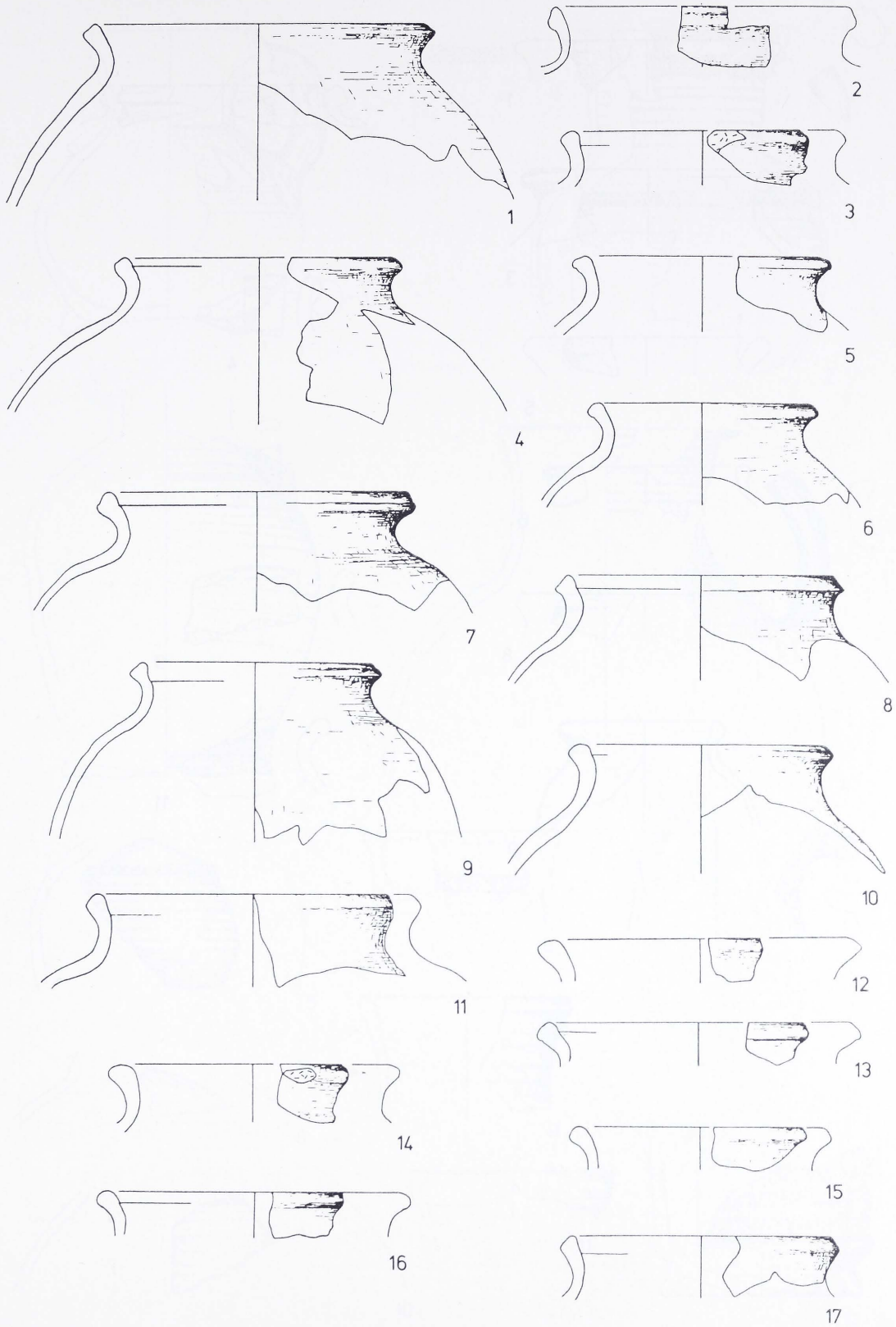

Tafel: 15
 Maßstab: 1:3
 Komplex: 4

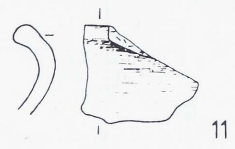
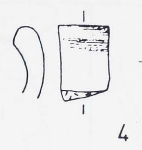
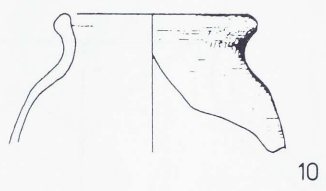
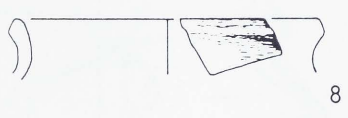
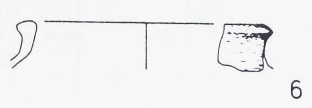
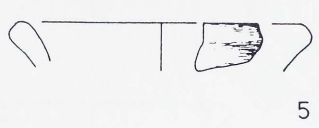
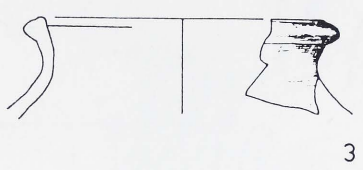
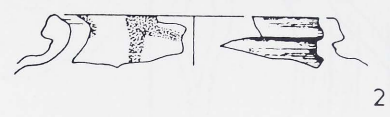
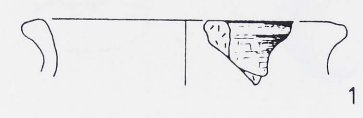

Tafel: 16
Maßstab: 1:3
Komplex: 4

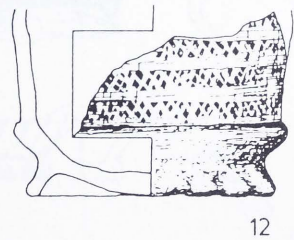
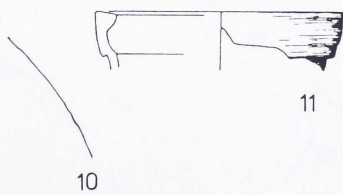
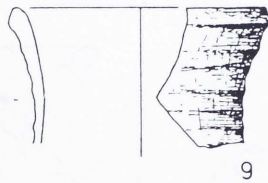
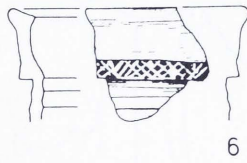
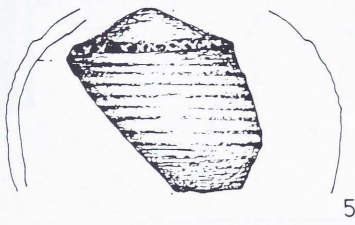
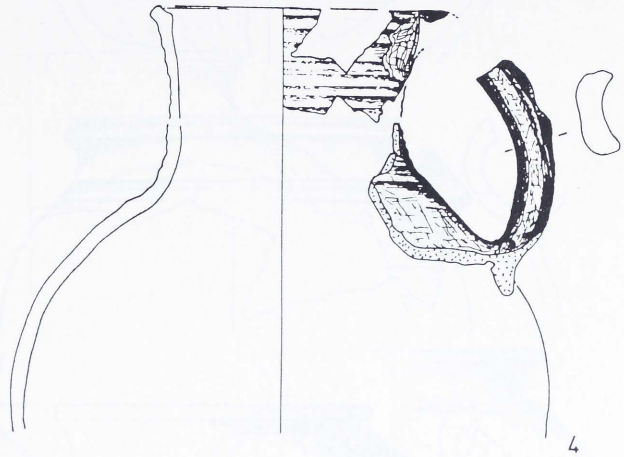
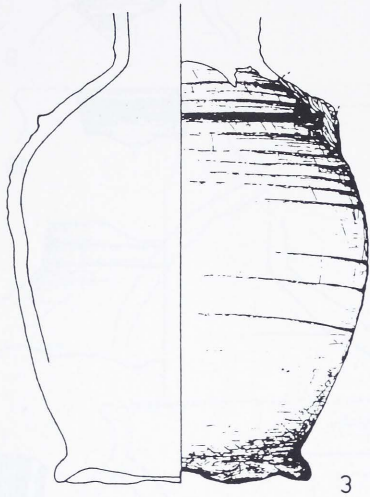
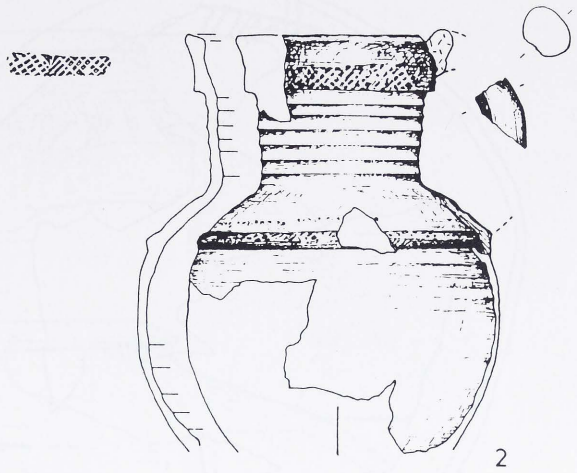
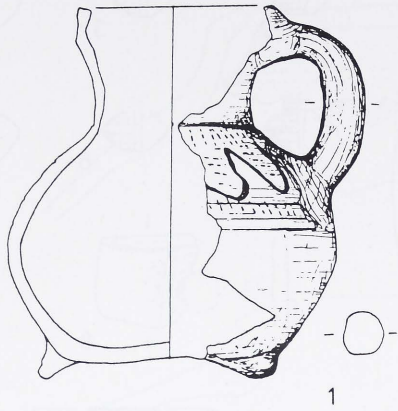

Tafel:17
Maßstab: 1:3
Komplex: 5

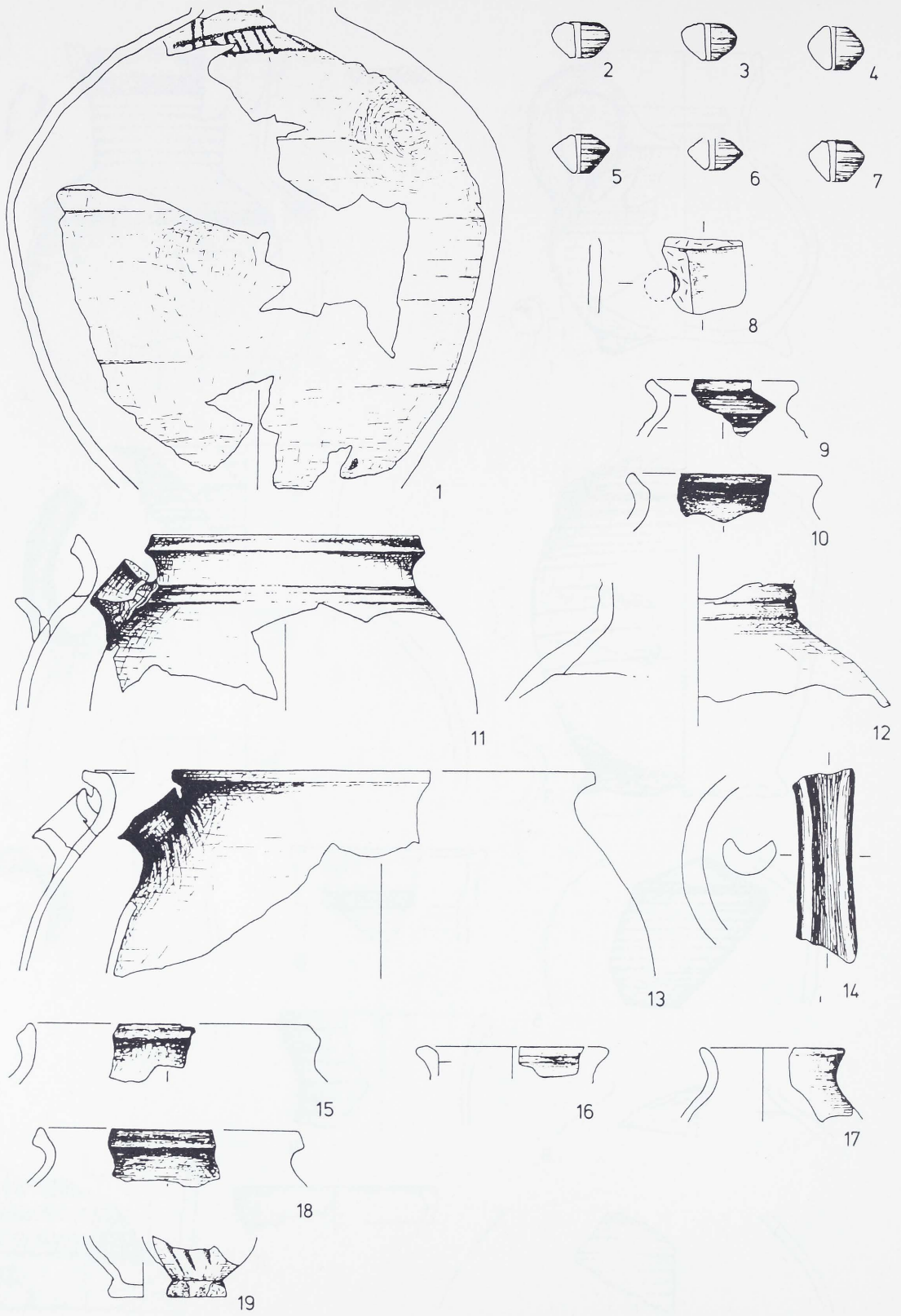

Tafel: 18
 Maßstab: 1:3
 Komplex: 5

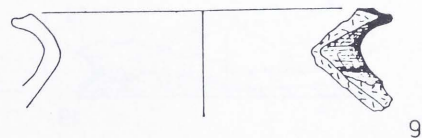
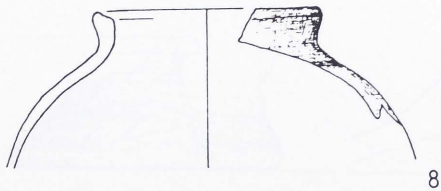
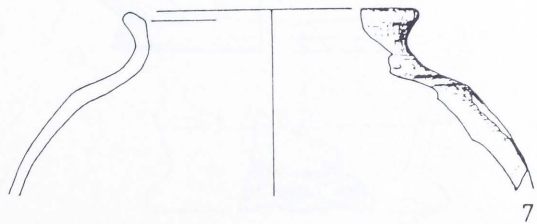
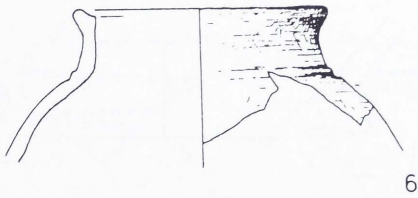
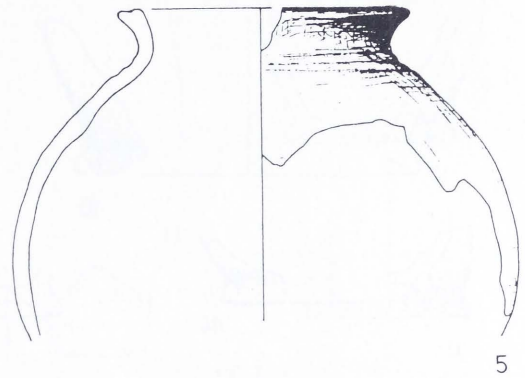
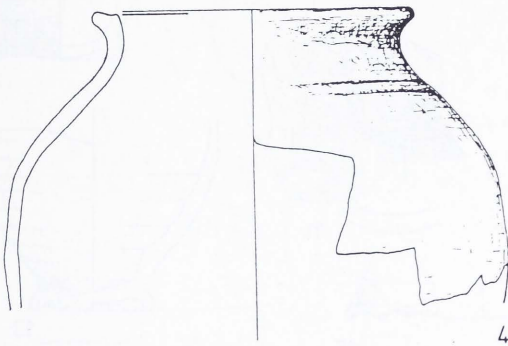
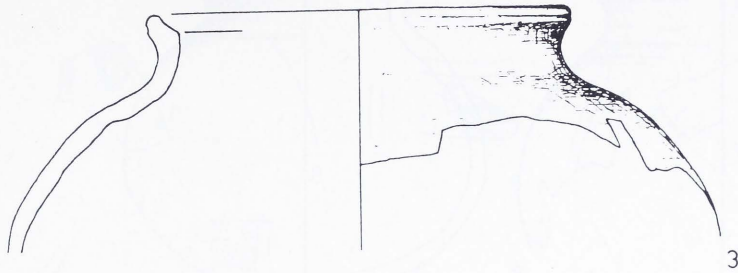
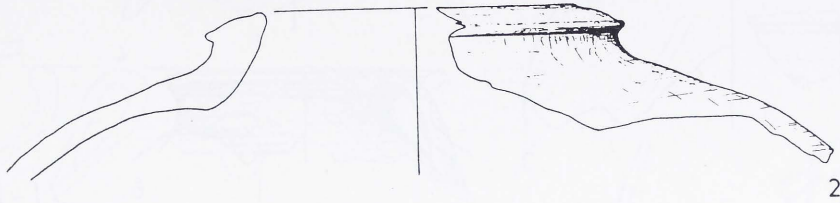
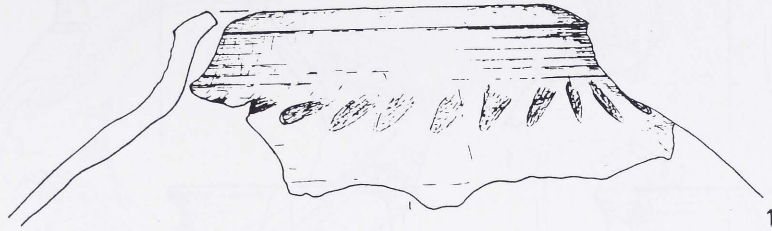

Tafel: 19
Maßstab: 1:3
Komplex: 5

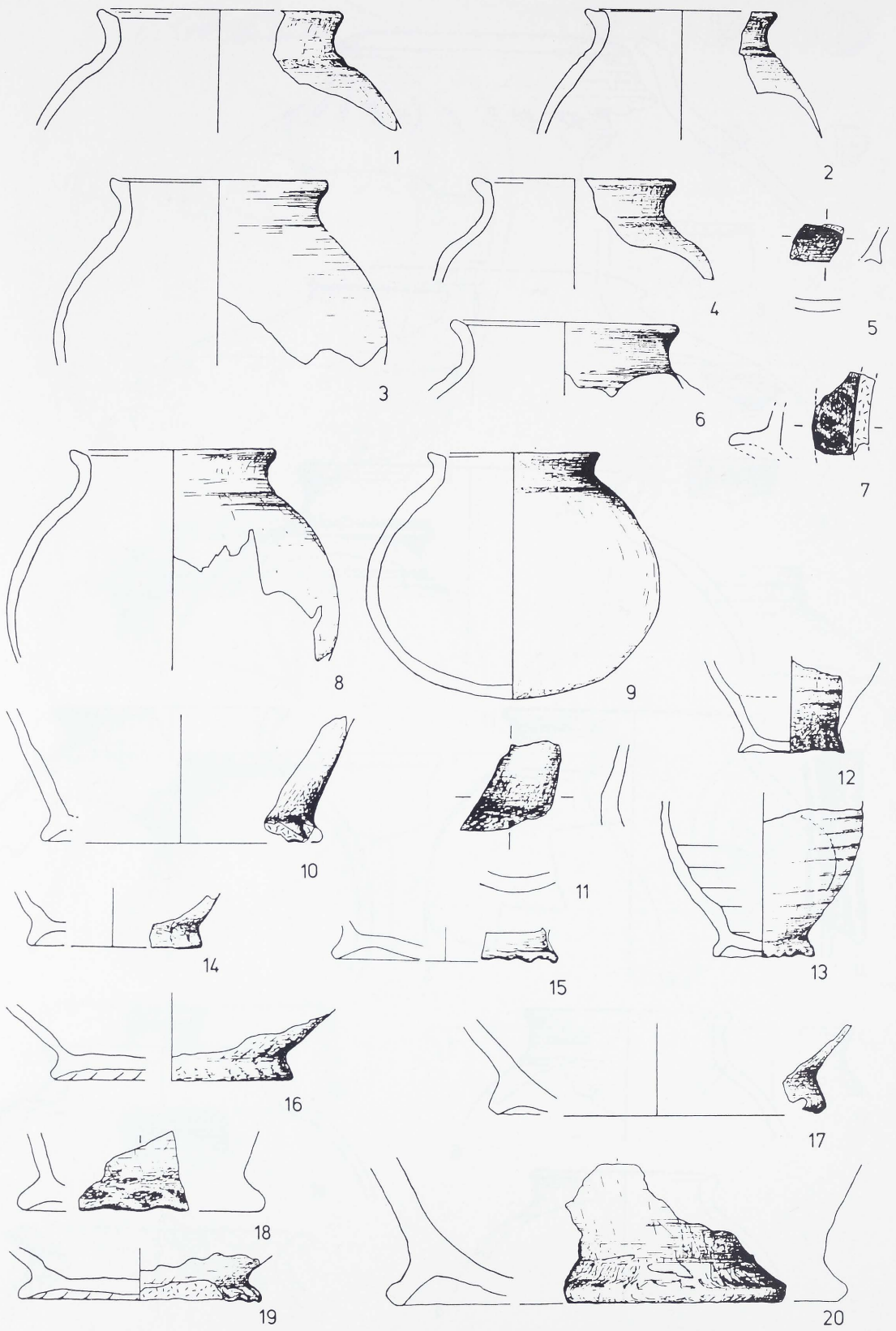

Tafel: 20
 Maßstab: 1:3
 Komplex: 5

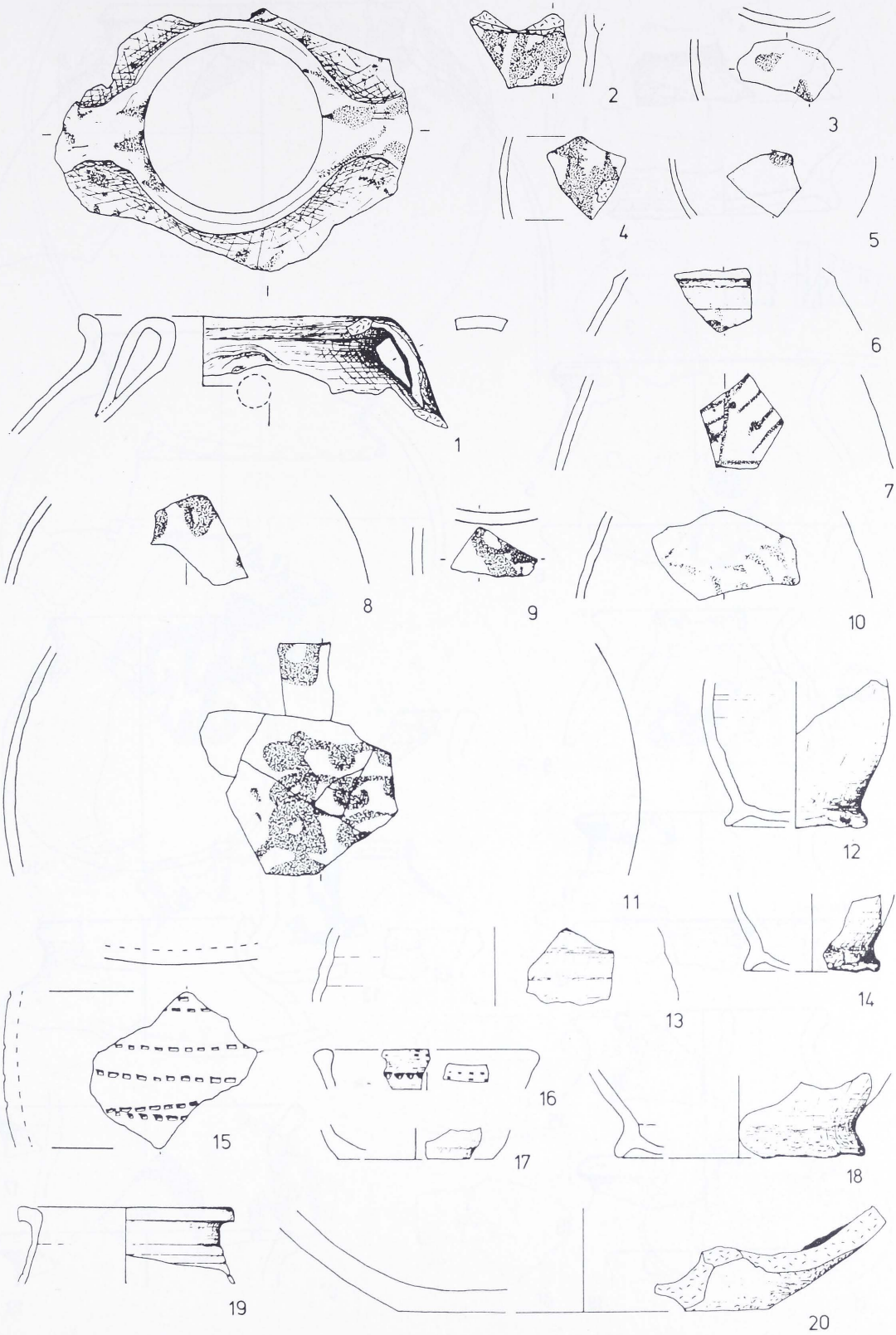

Tafel: 21
 Maßstab: 1:3
 Komplex: 7

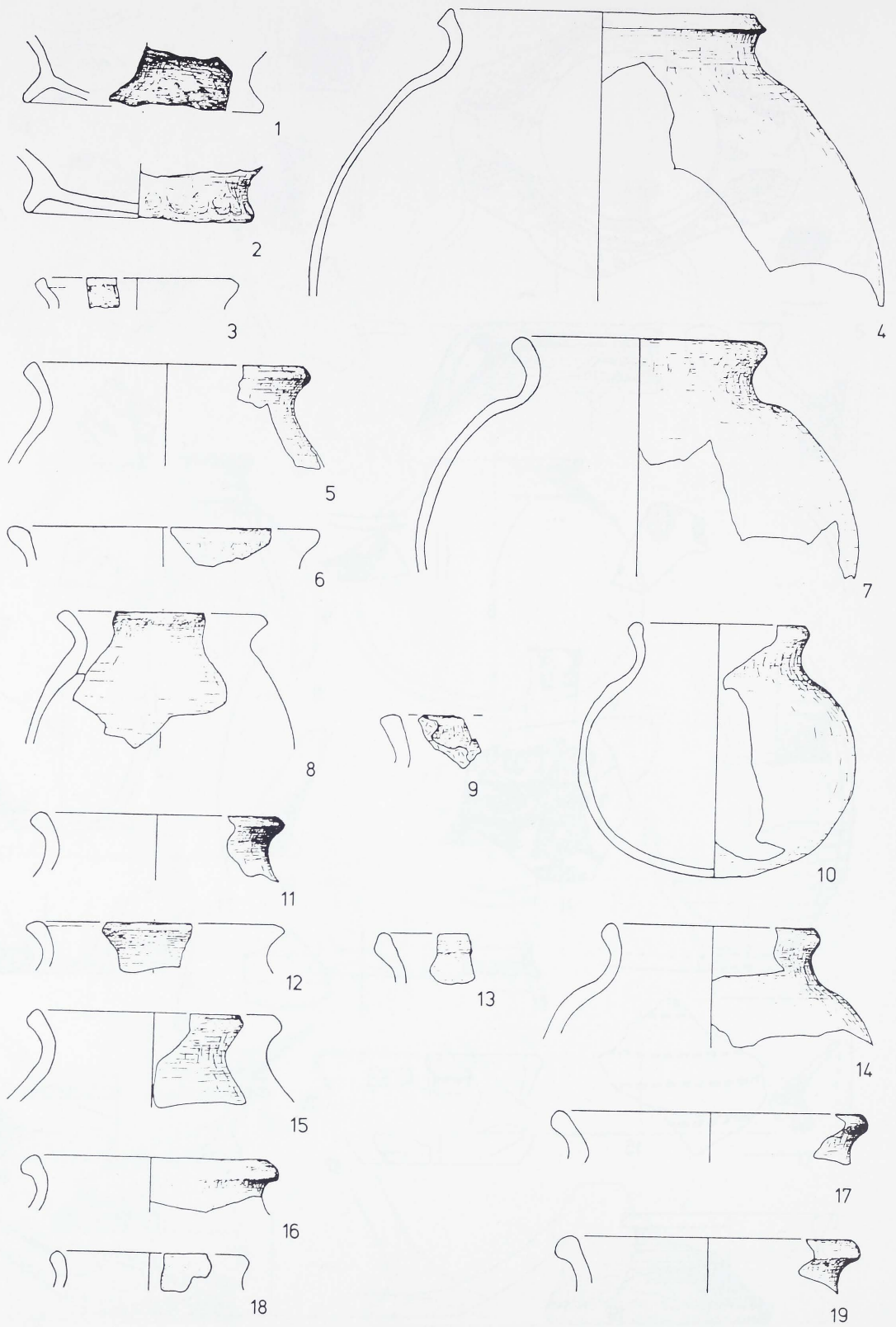

Tafel: 22
 Maßstab: 1:3
 Komplex: 7

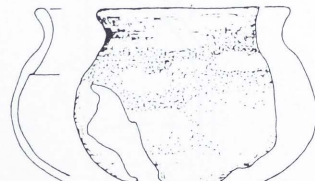
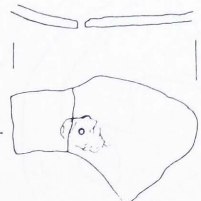
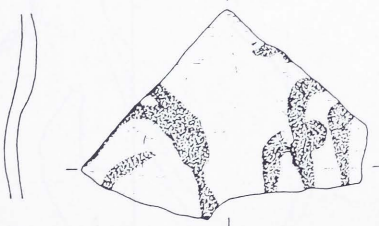
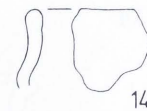
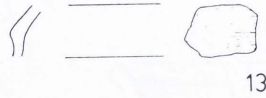
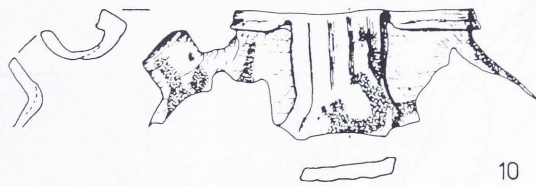
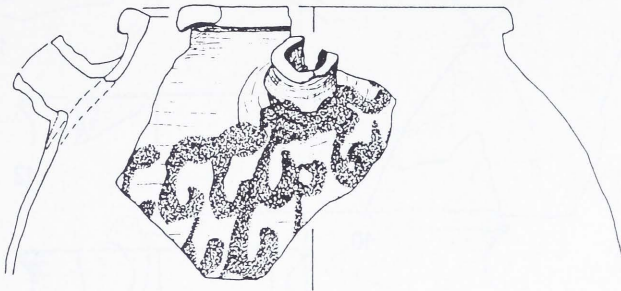
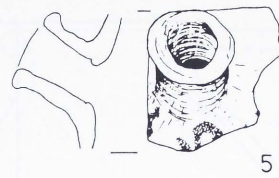
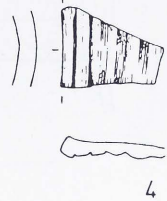
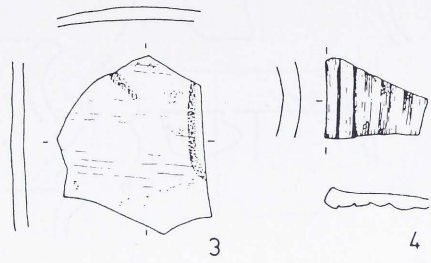
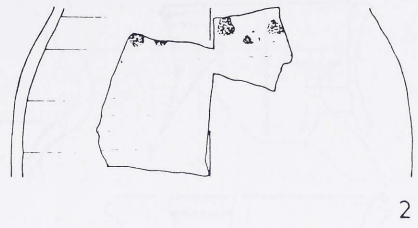

15

16

17

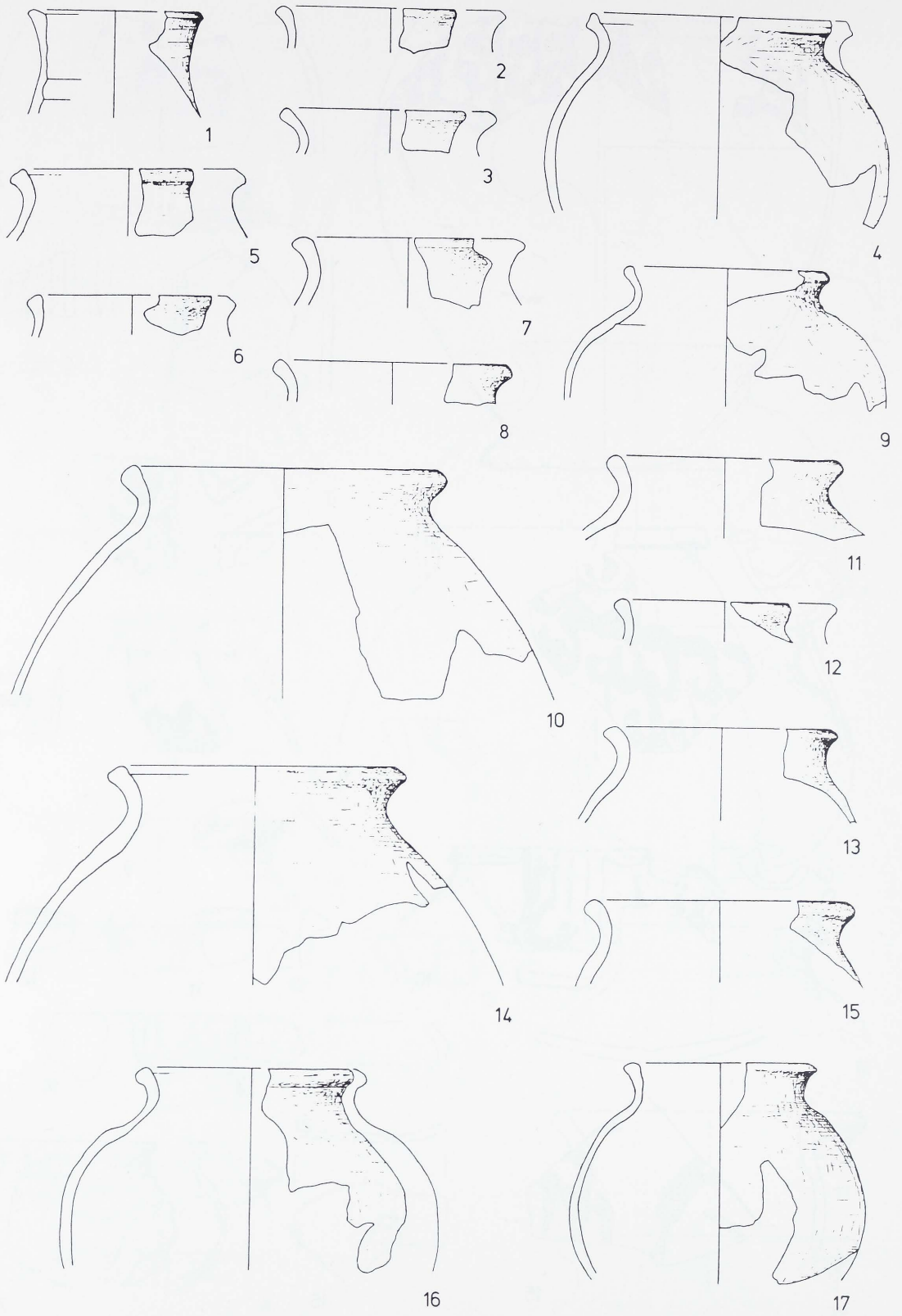

Tafel: 24
 Maßstab: 1:3
 Komplex: 9

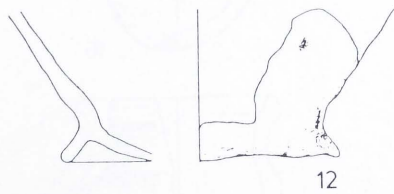
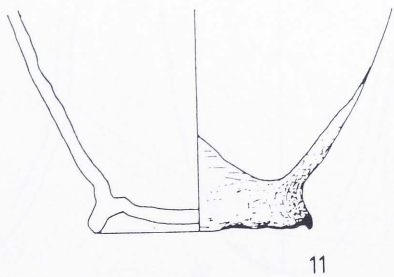
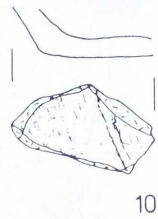
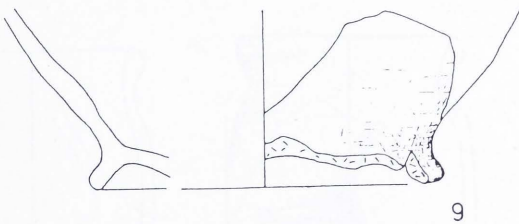
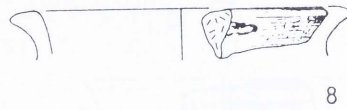
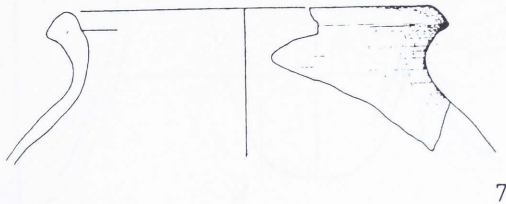
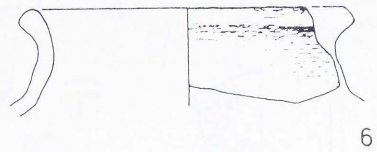
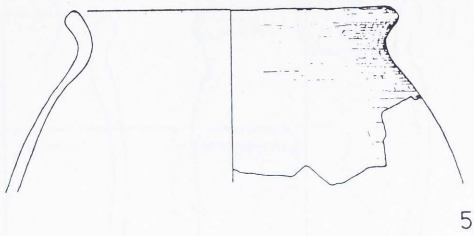
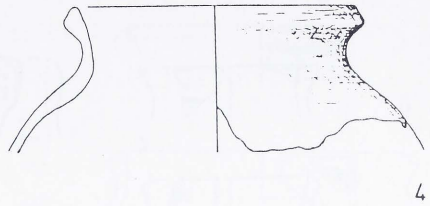
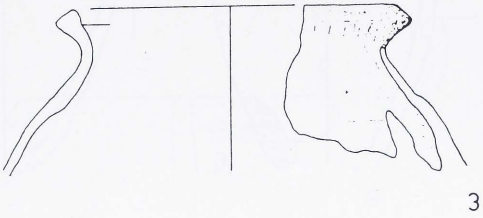
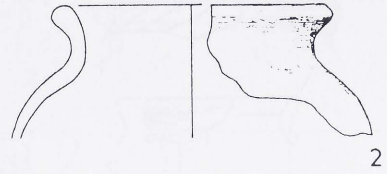
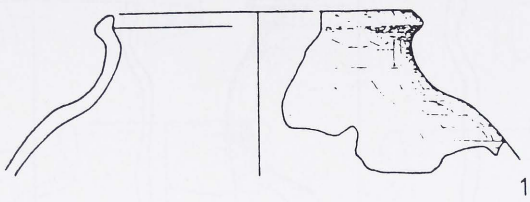

Tafel: 25
Maßstab: 1:3
Komplex: 9

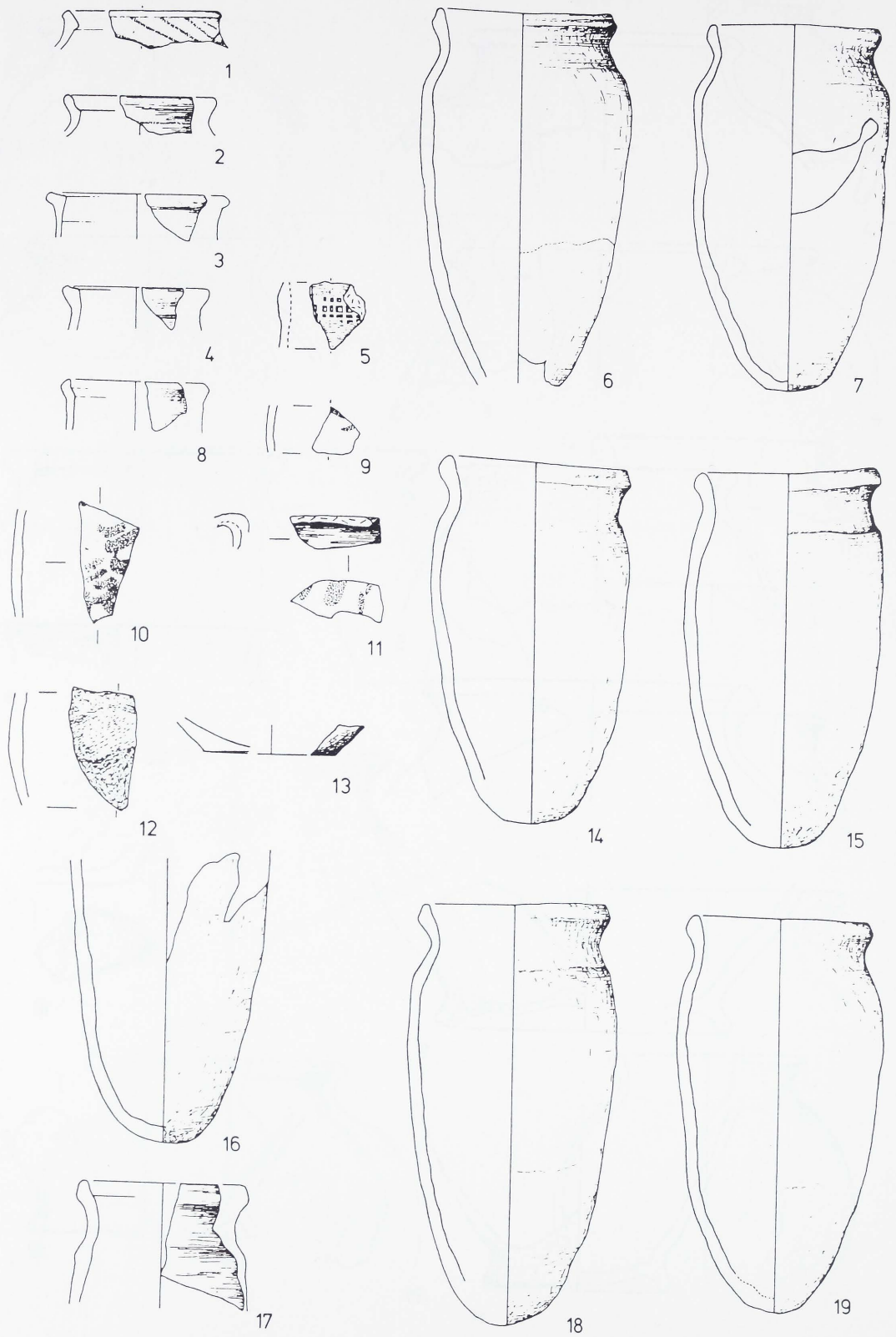

Tafel: 26
 Maßstab: 1:3
 Komplex: 10

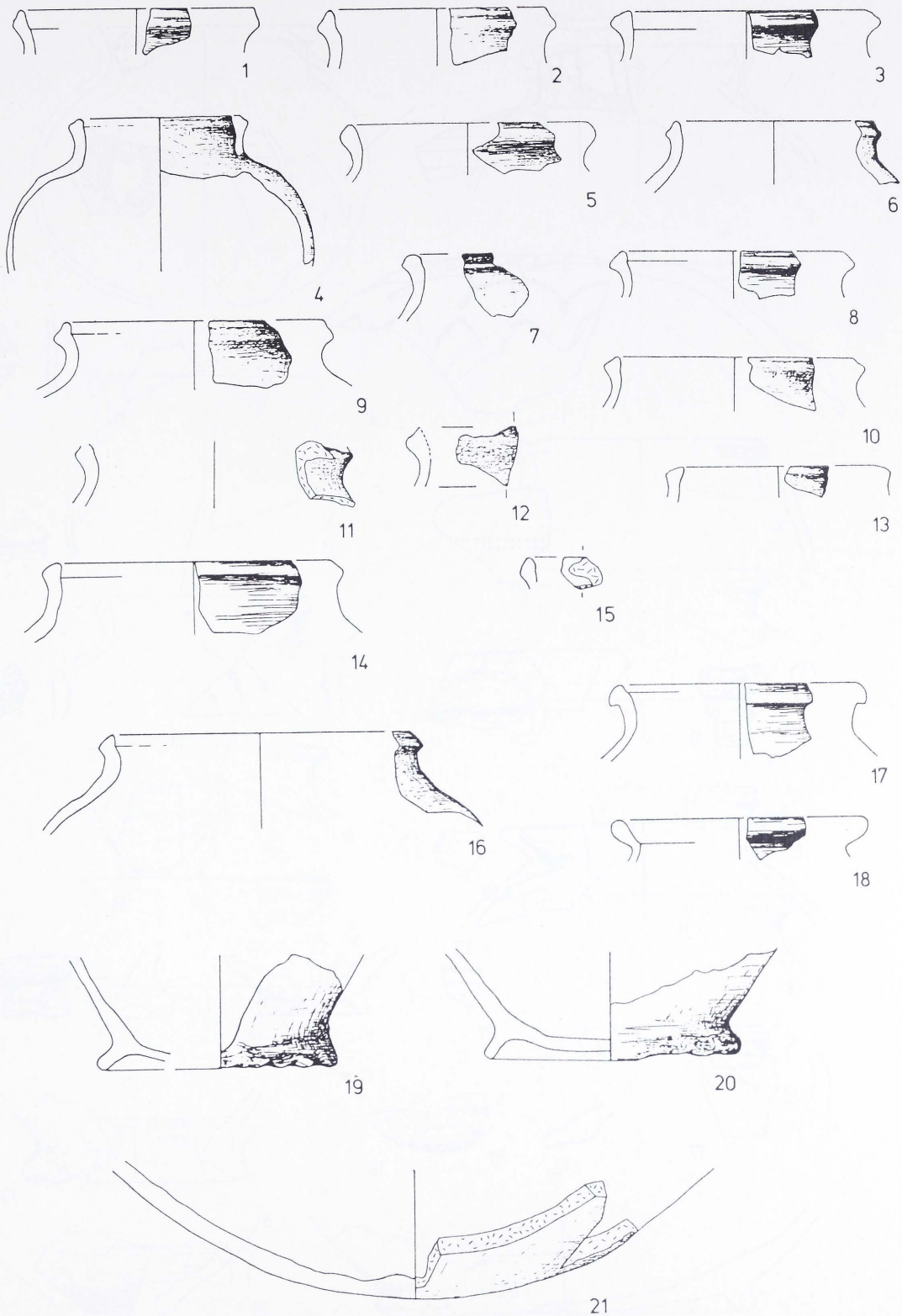

Tafel: 27
 Maßstab: 1:3
 Komplex: 10



Tafel: 28
 Maßstab: 1:3
 Komplex: 13

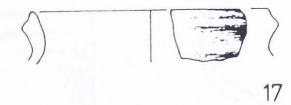
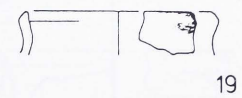
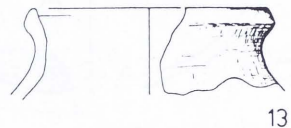
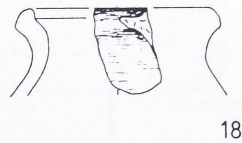
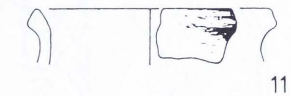
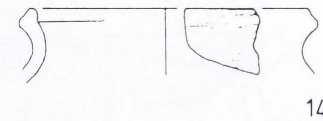
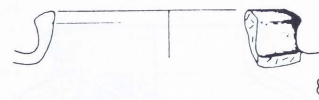
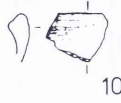
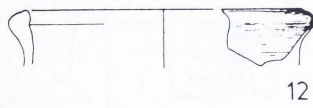
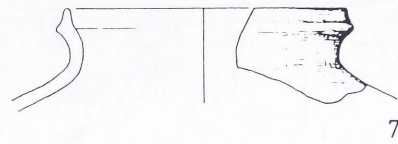
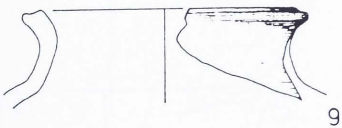
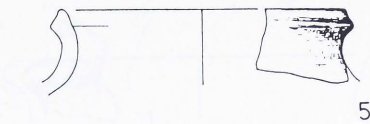
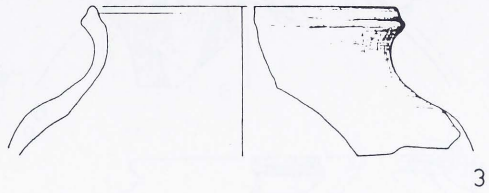
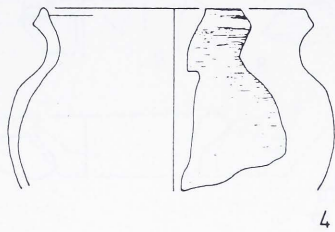
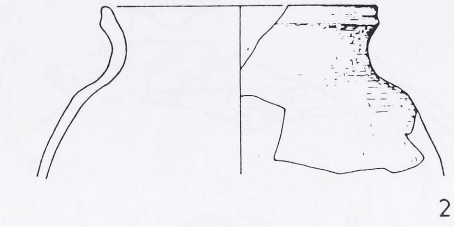
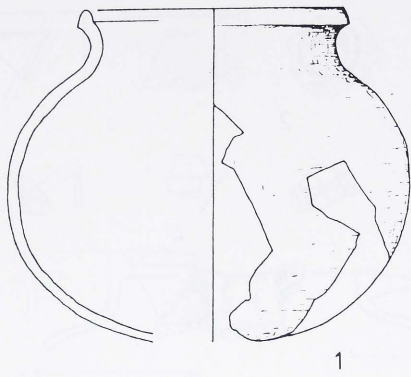

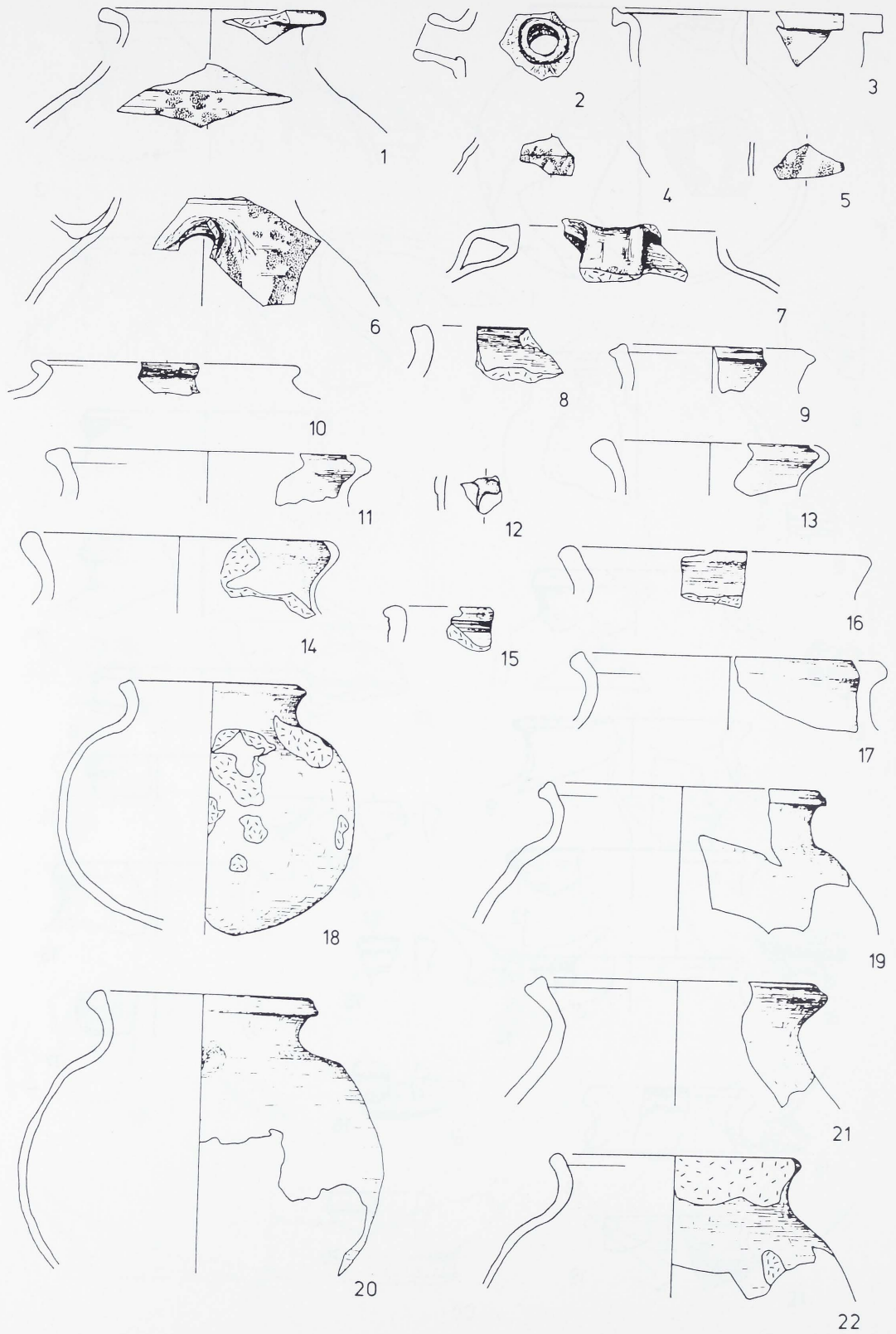

Tafel: 30
 Maßstab: 1:3
 Komplex: 14

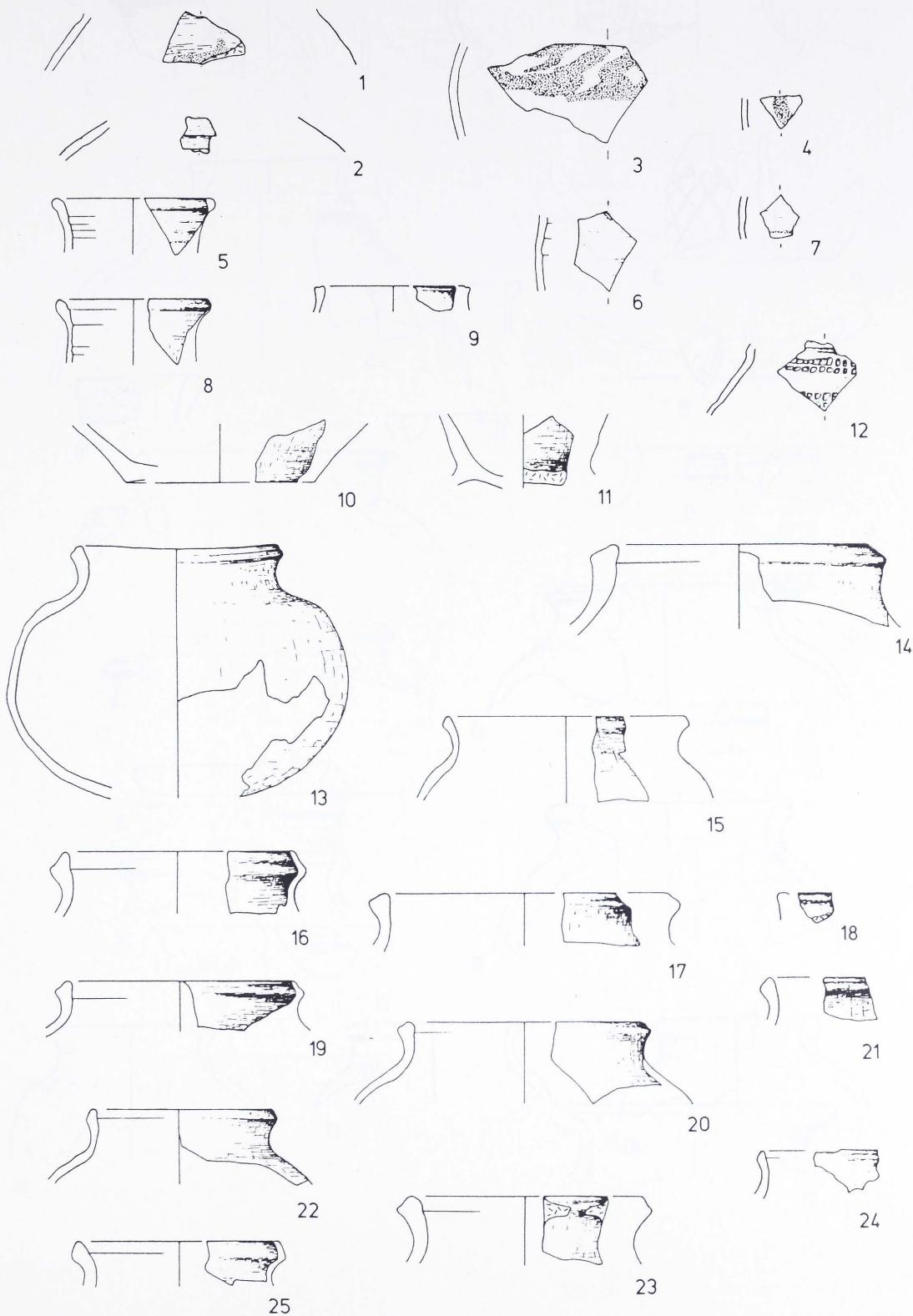

Tafel: 31
 Maßstab: 1:3
 Komplex: 15

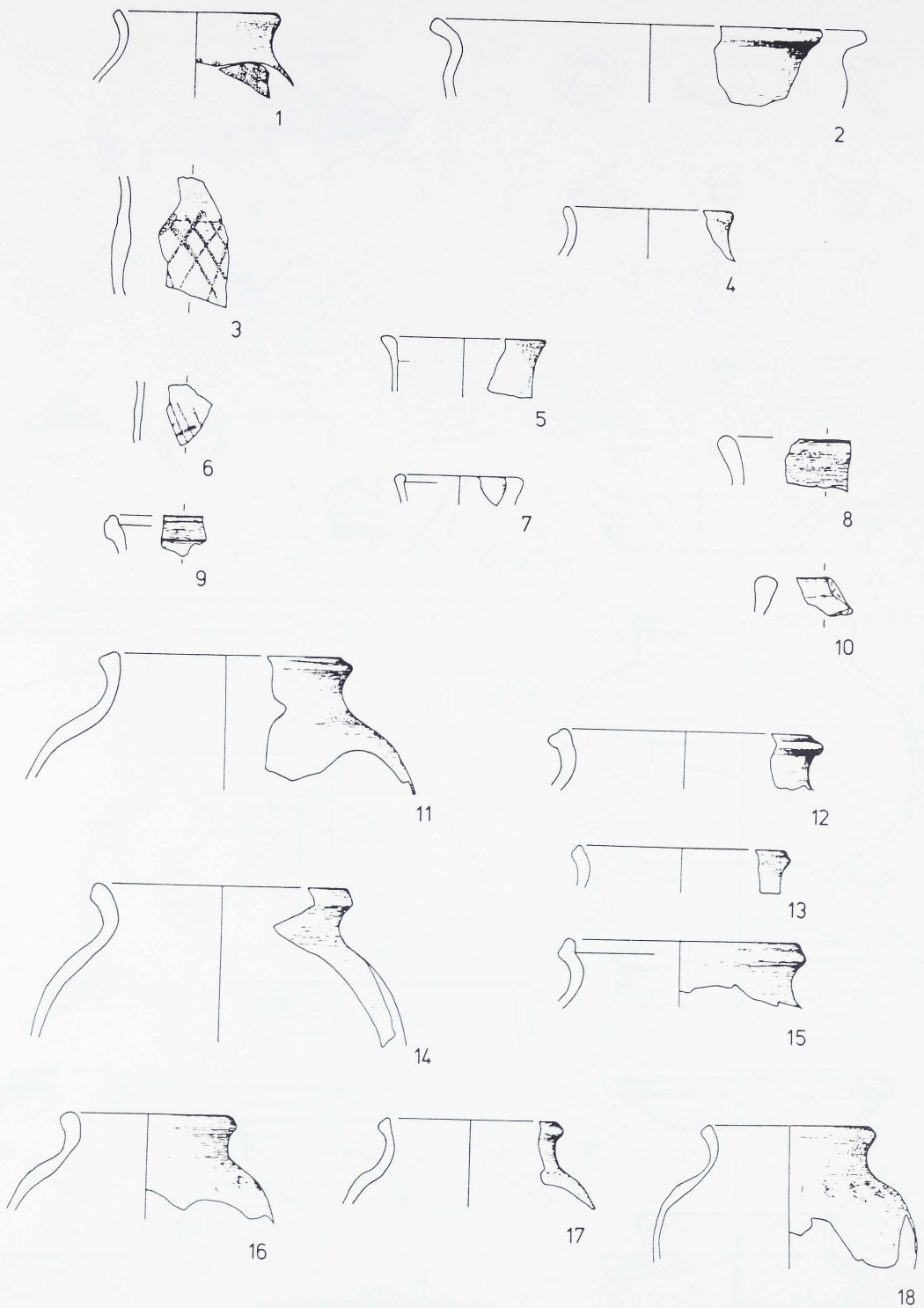

Tafel: 32
 Maßstab: 1:3
 Komplex: 16

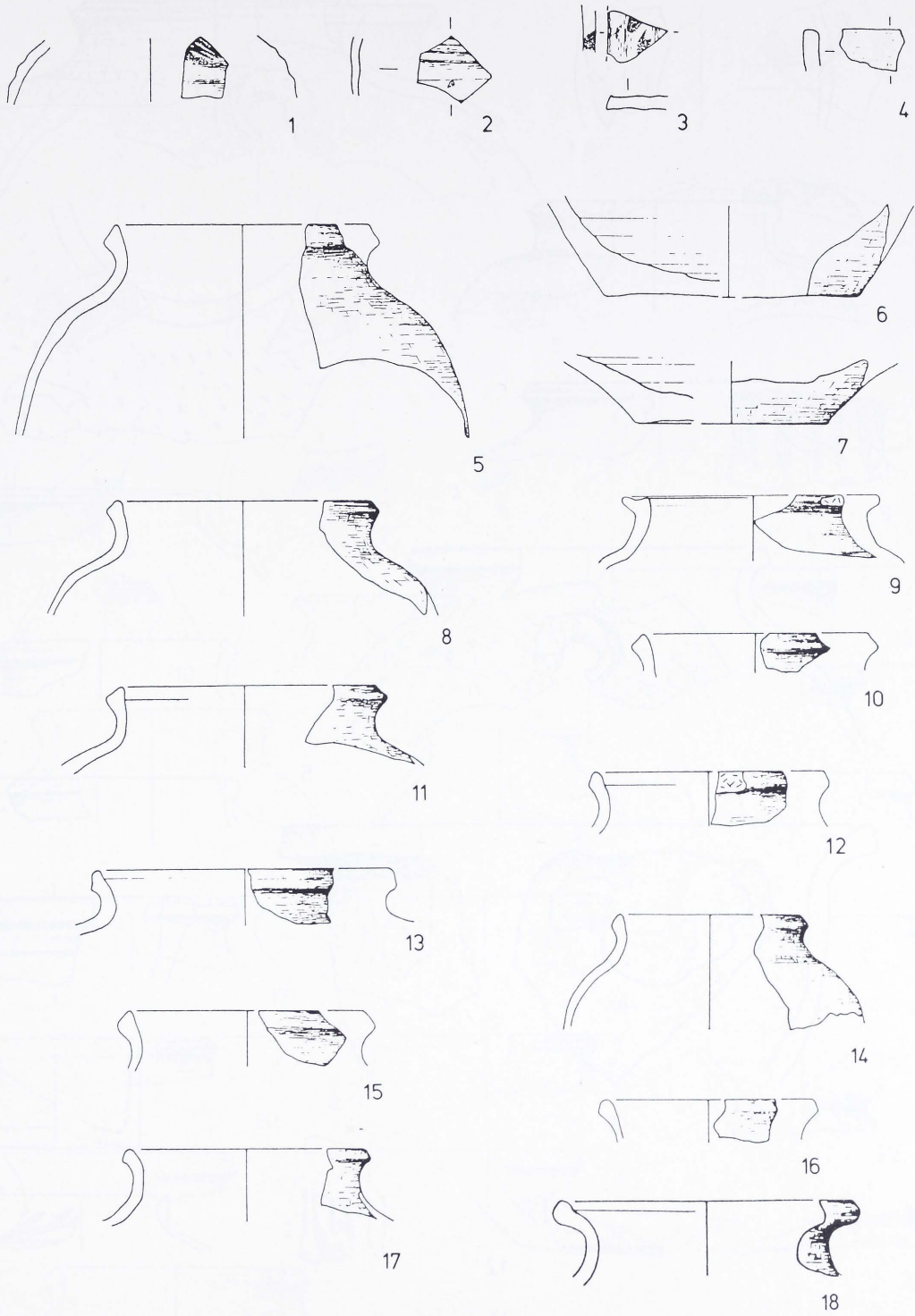

Tafel: 33
 Maßstab: 1:3
 Komplex: 18

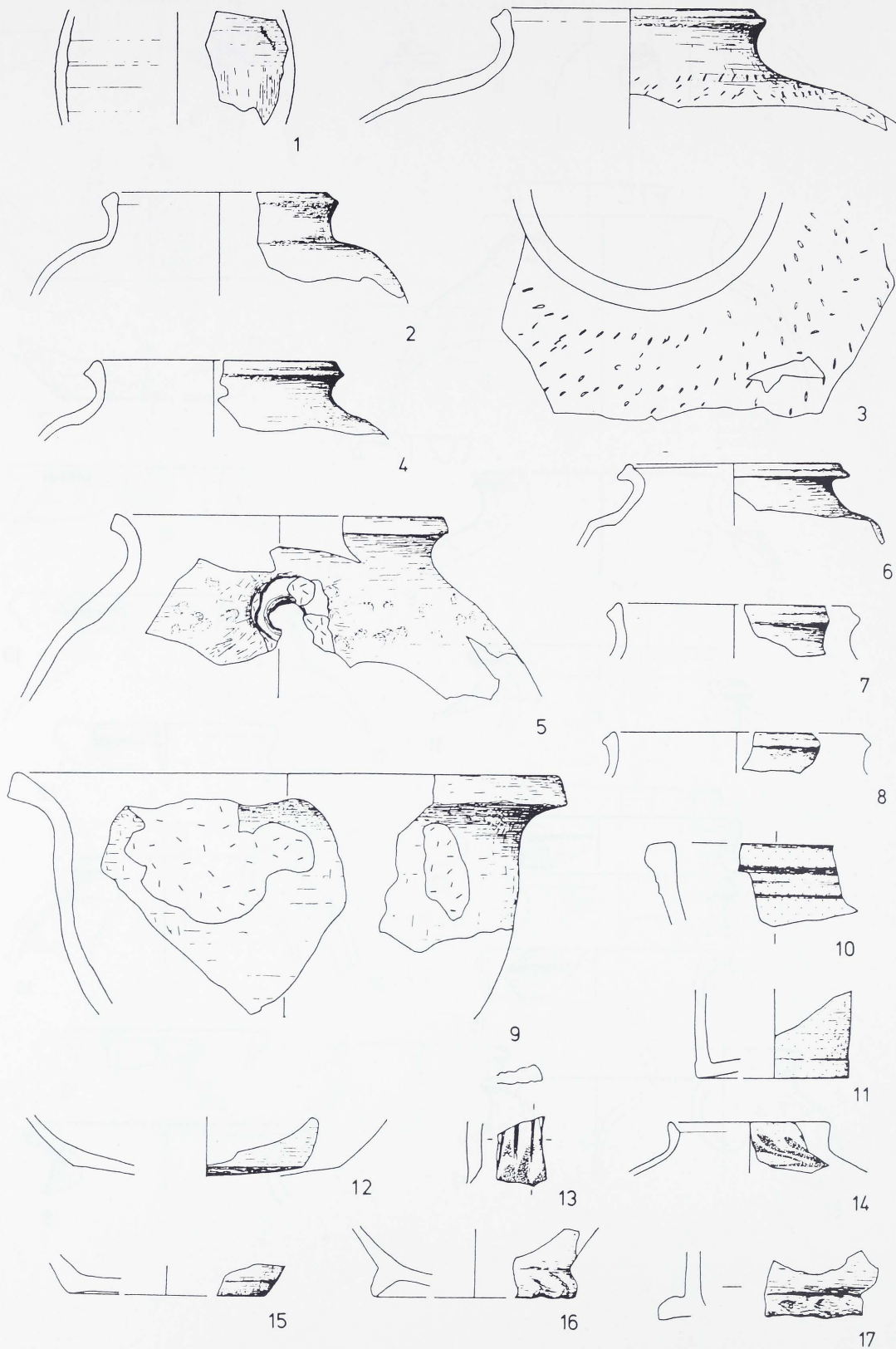

Tafel: 34
 Maßstab: 1:3
 Komplex: 20

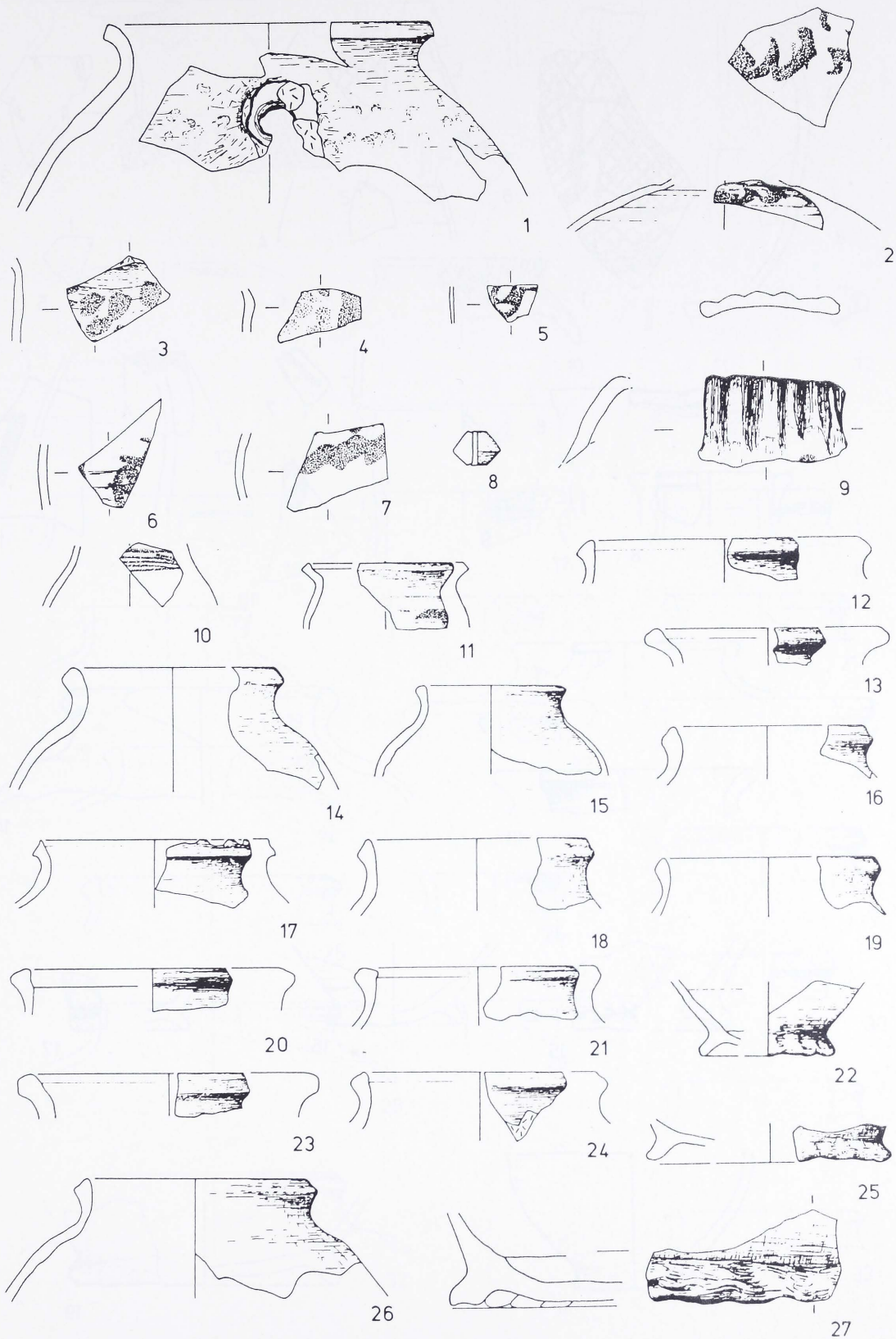

Tafel: 35
 Maßstab: 1:3
 Komplex: 21

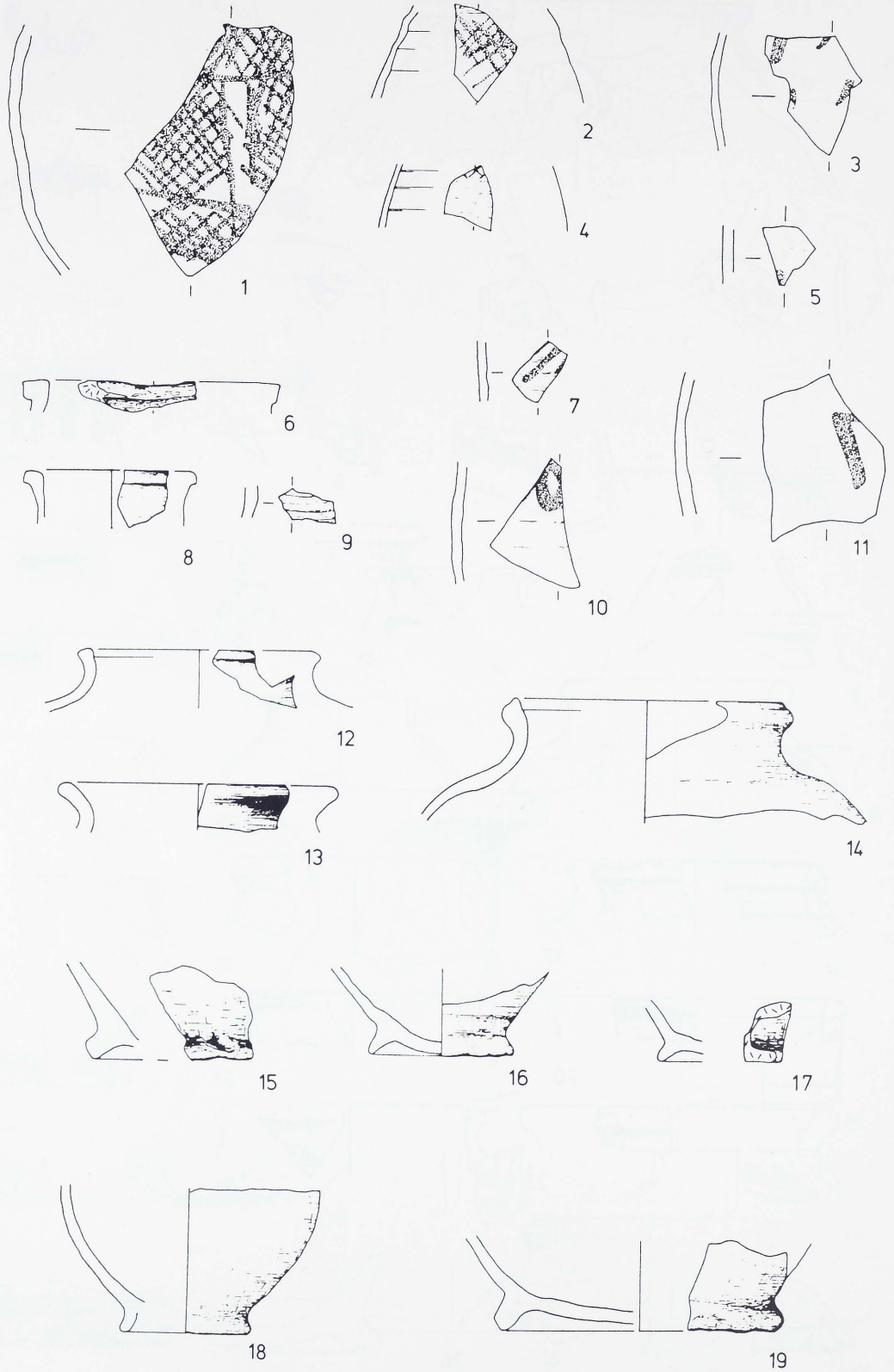

Tafel: 36
 Maßstab: 1:3
 Komplex: 22

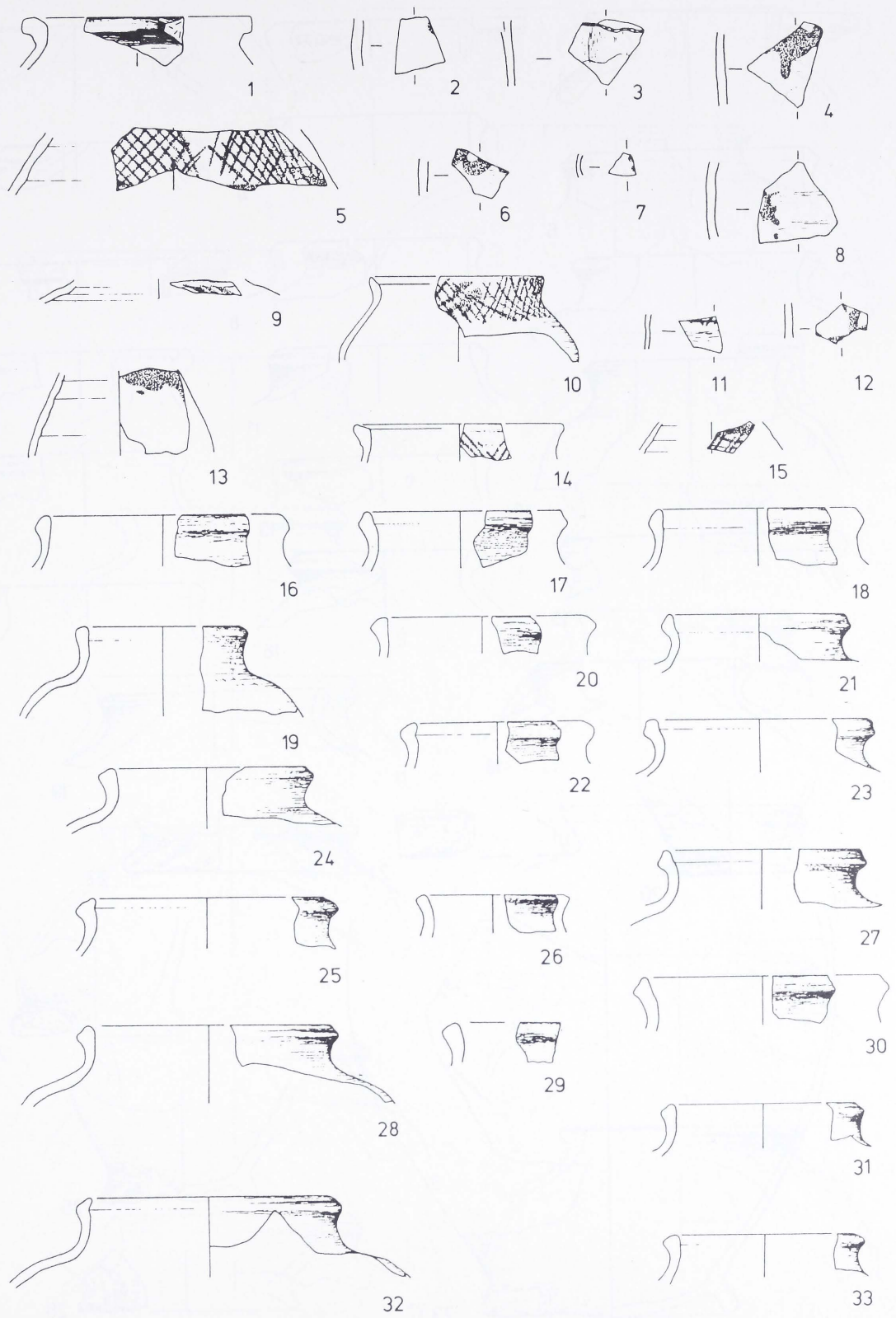

Tafel: 37
 Maßstab: 1:3
 Komplex: 23

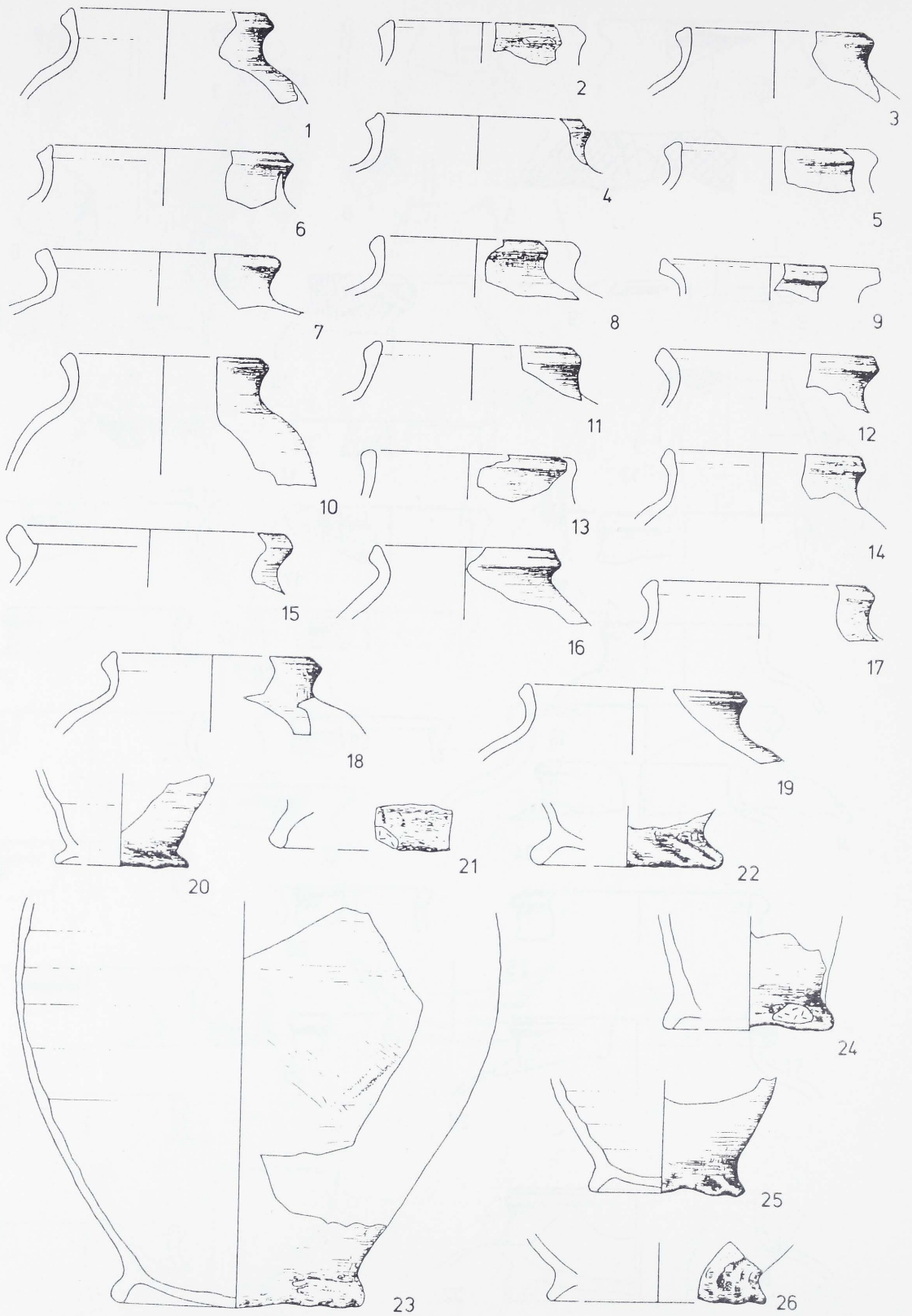

Tafel: 38
 Maßstab: 1:3
 Komplex: 23

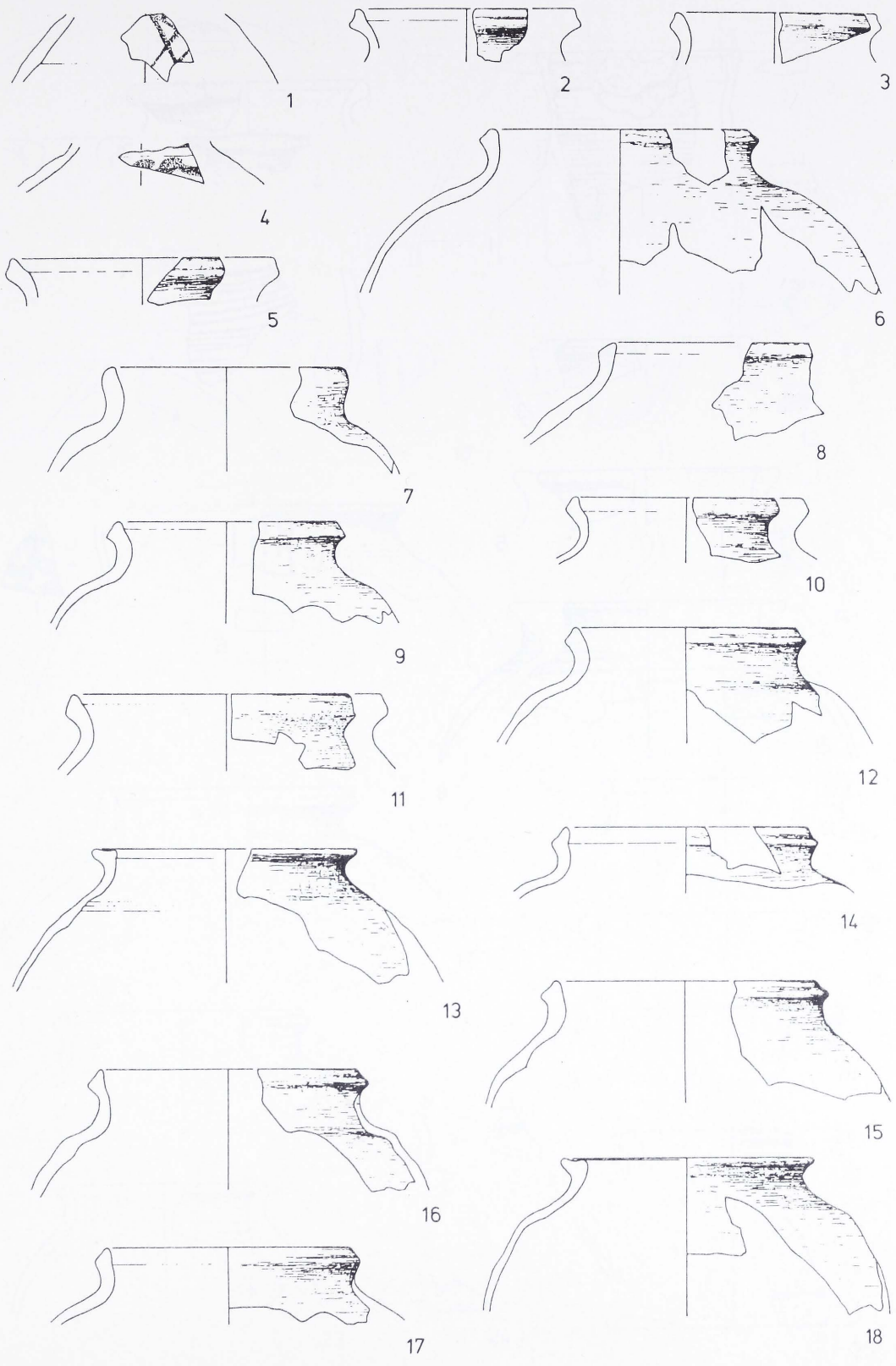

Tafel: 39
 Maßstab: 1:3
 Komplex: 24

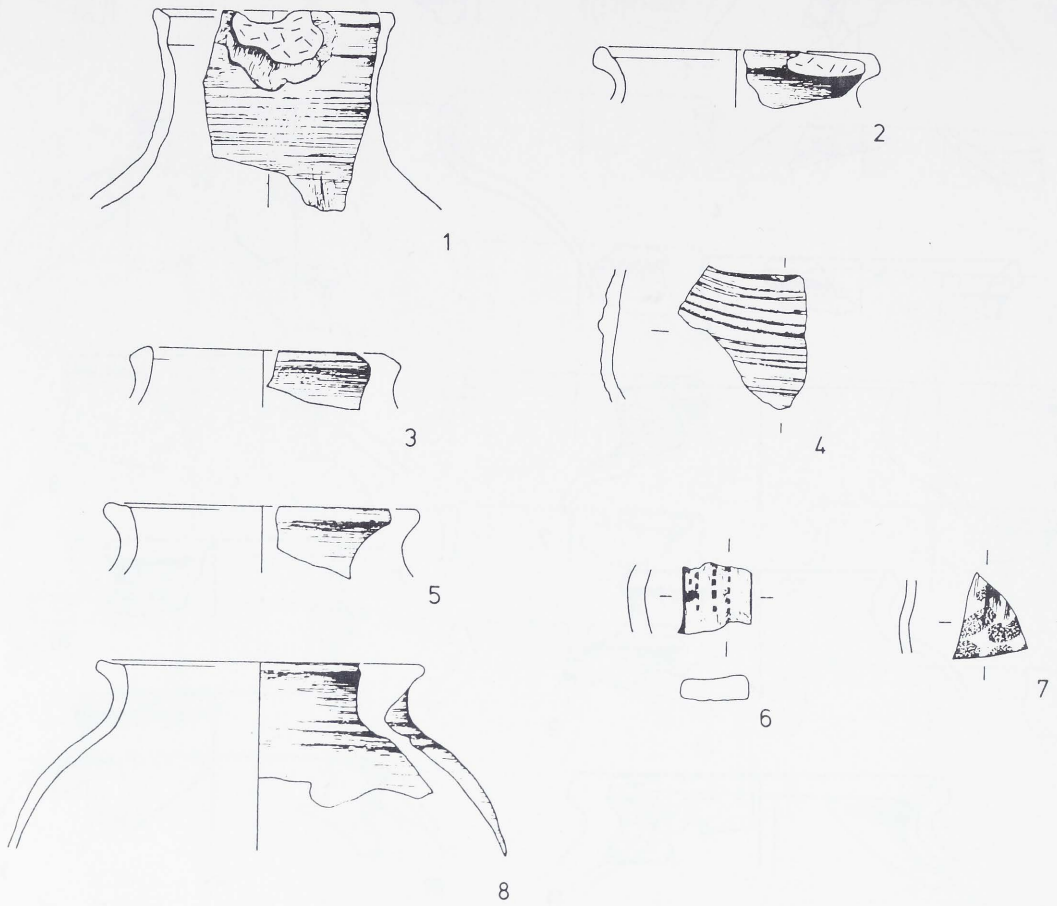

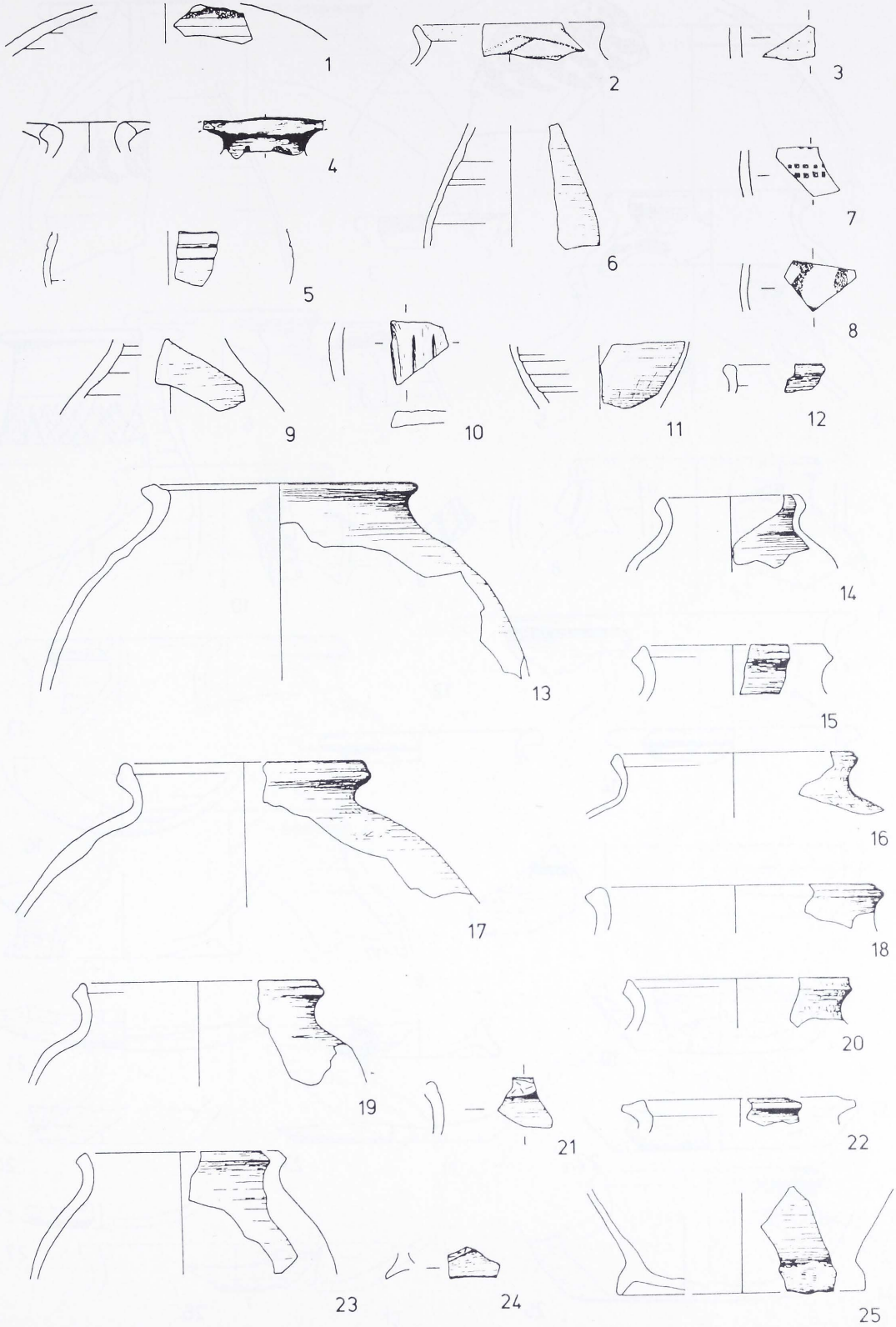

Tafel: 41
 Maßstab: 1:3
 Komplex: 28

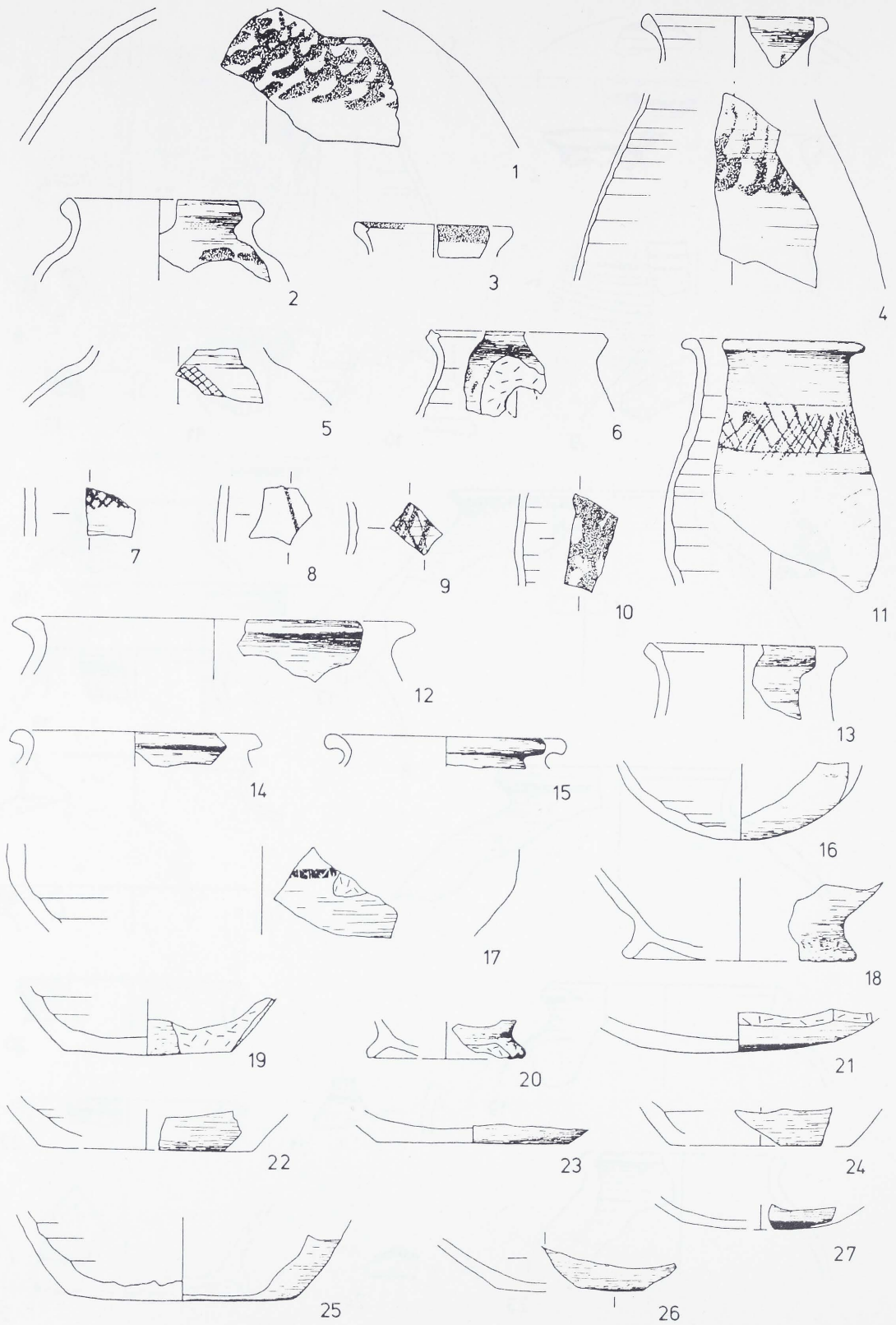

Tafel: 42
 Maßstab: 1:3
 Komplex: 30

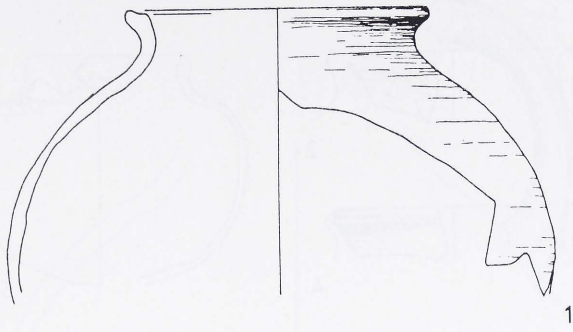

1

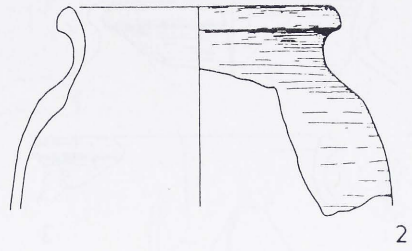

2

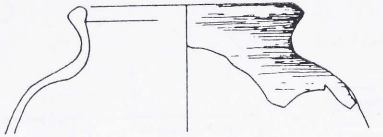

3

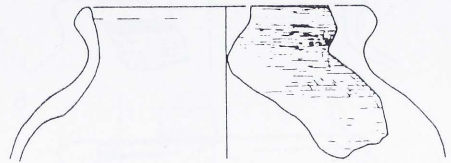

4

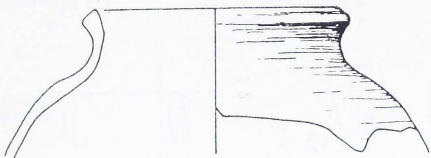

5

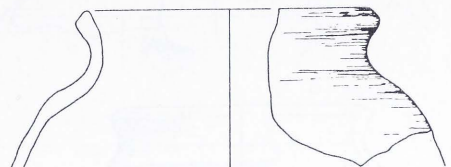

6

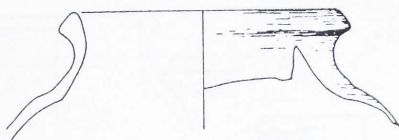

7

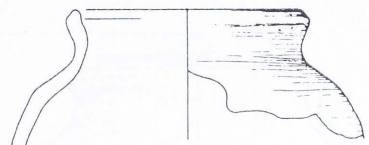

8

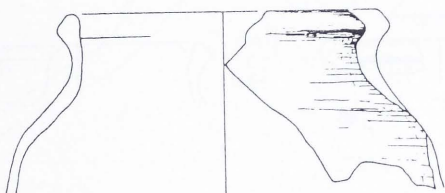

9

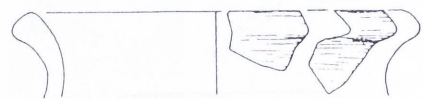

10

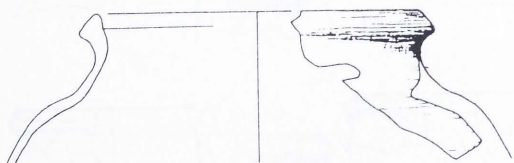

11

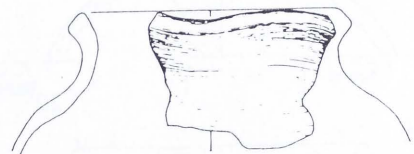

12



13

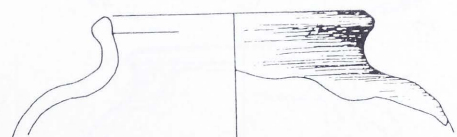

14

Tafel: 43
Maßstab: 1:3
Komplex: 30

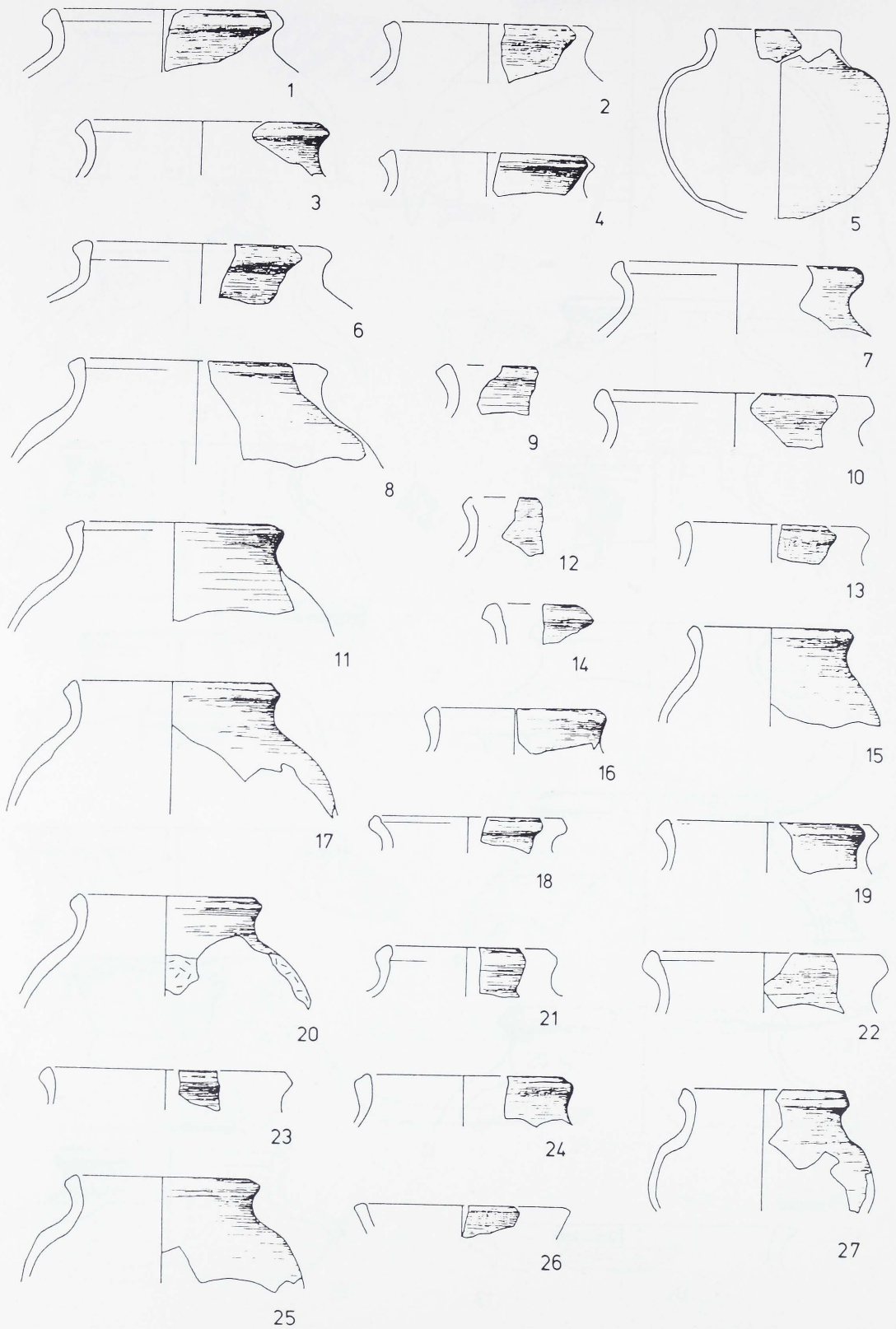

Tafel: 44
 Maßstab: 1:3
 Komplex: 30

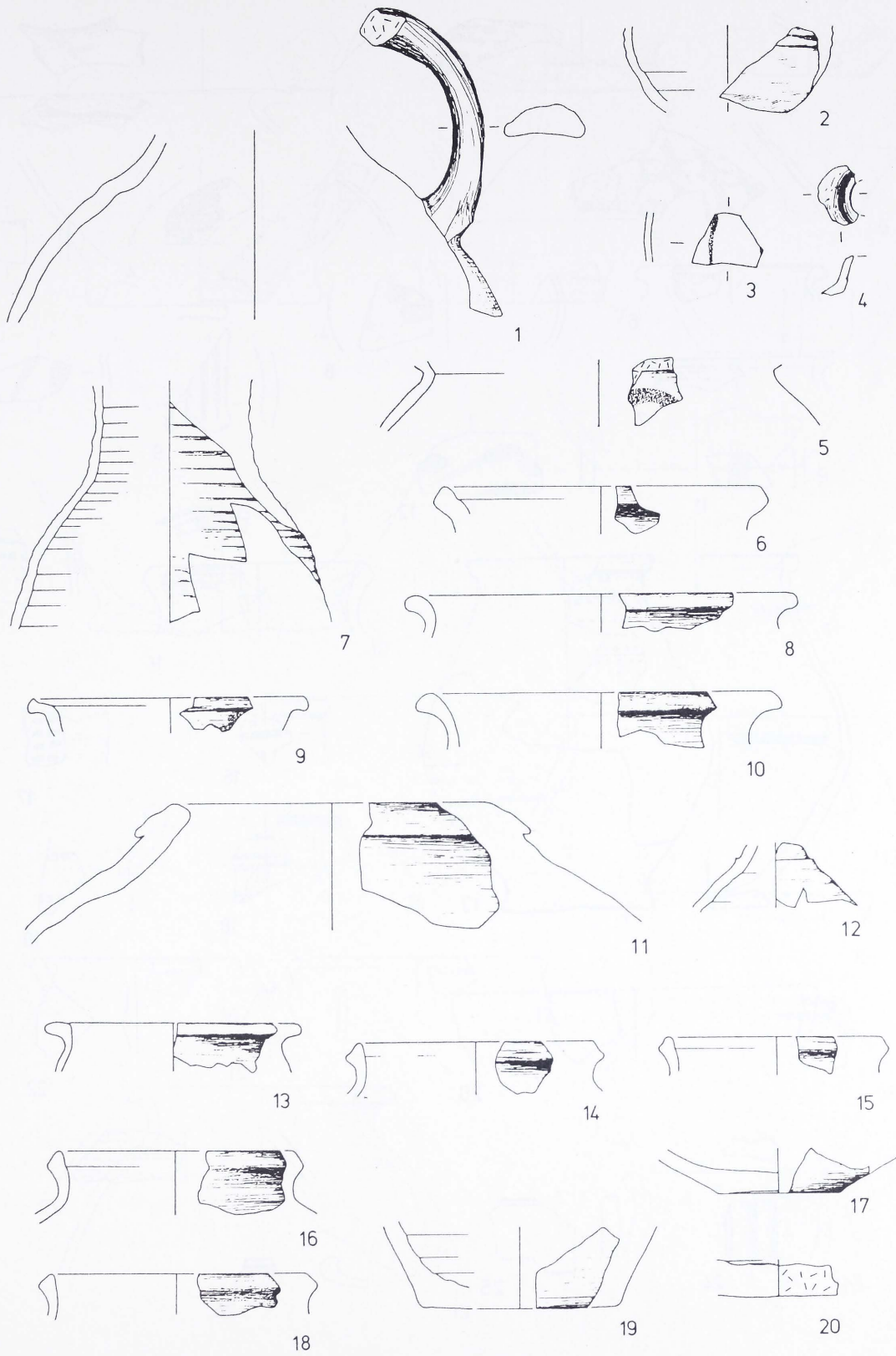

Tafel: 45
 Maßstab: 1:3
 Komplex: 31

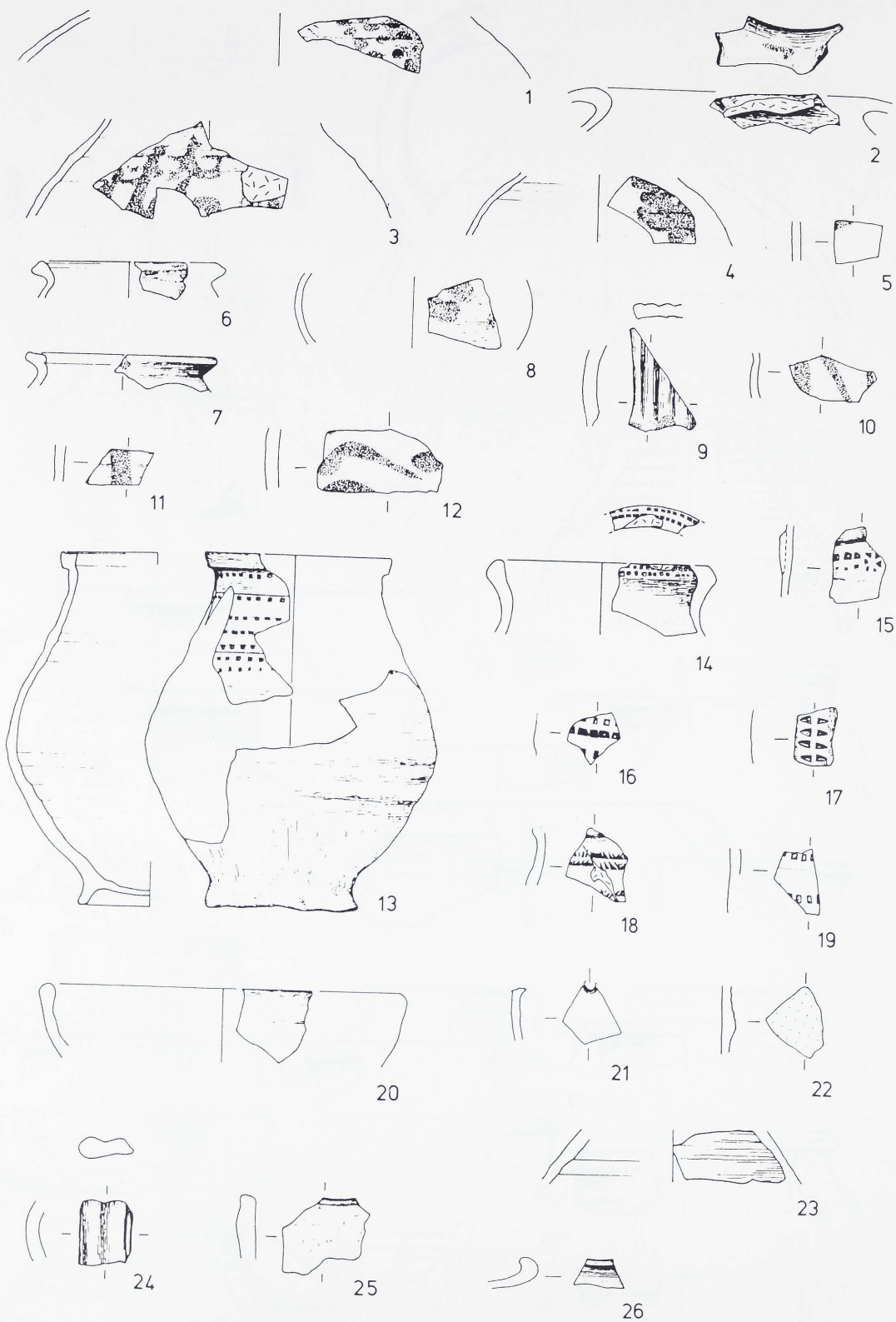

Tafel: 46
 Maßstab: 1:3
 Komplex: 32

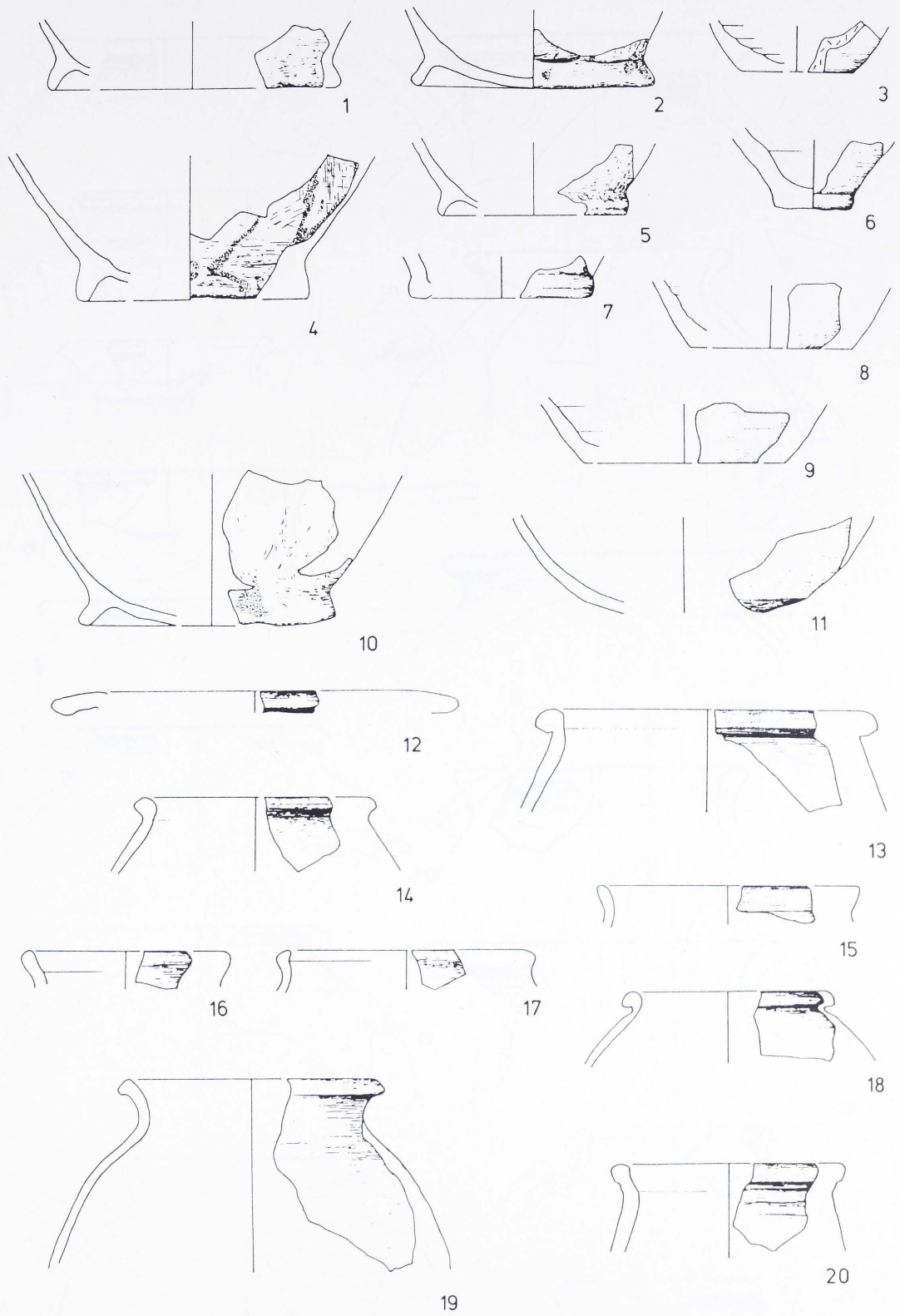

Tafel: 47
 Maßstab: 1:3
 Komplex: 32

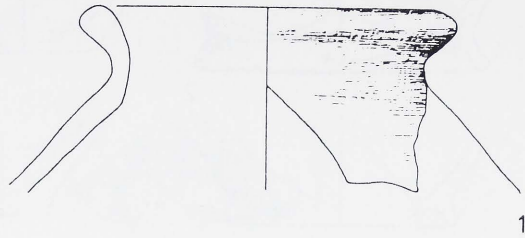

1



2

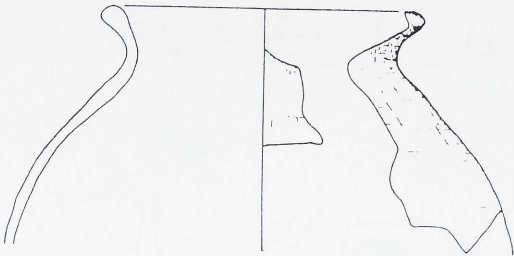

4



3



5

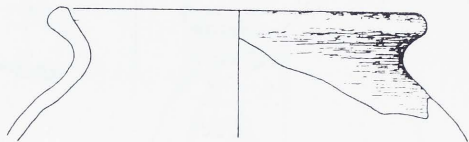

7



6



8



10



9

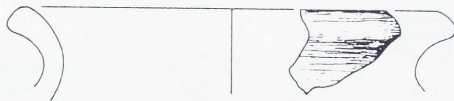

11

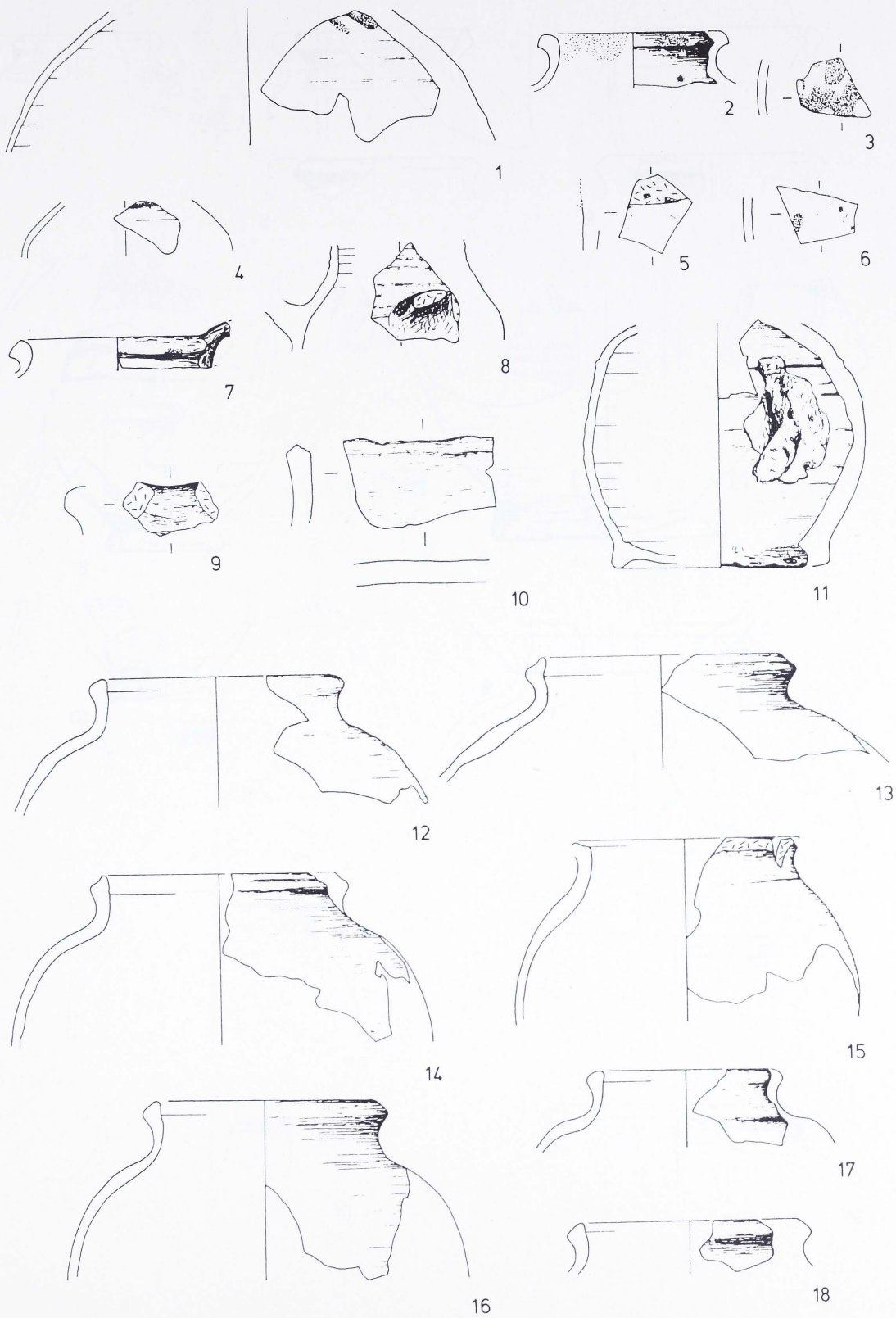

Tafel: 49
 Maßstab: 1:3
 Komplex: 34

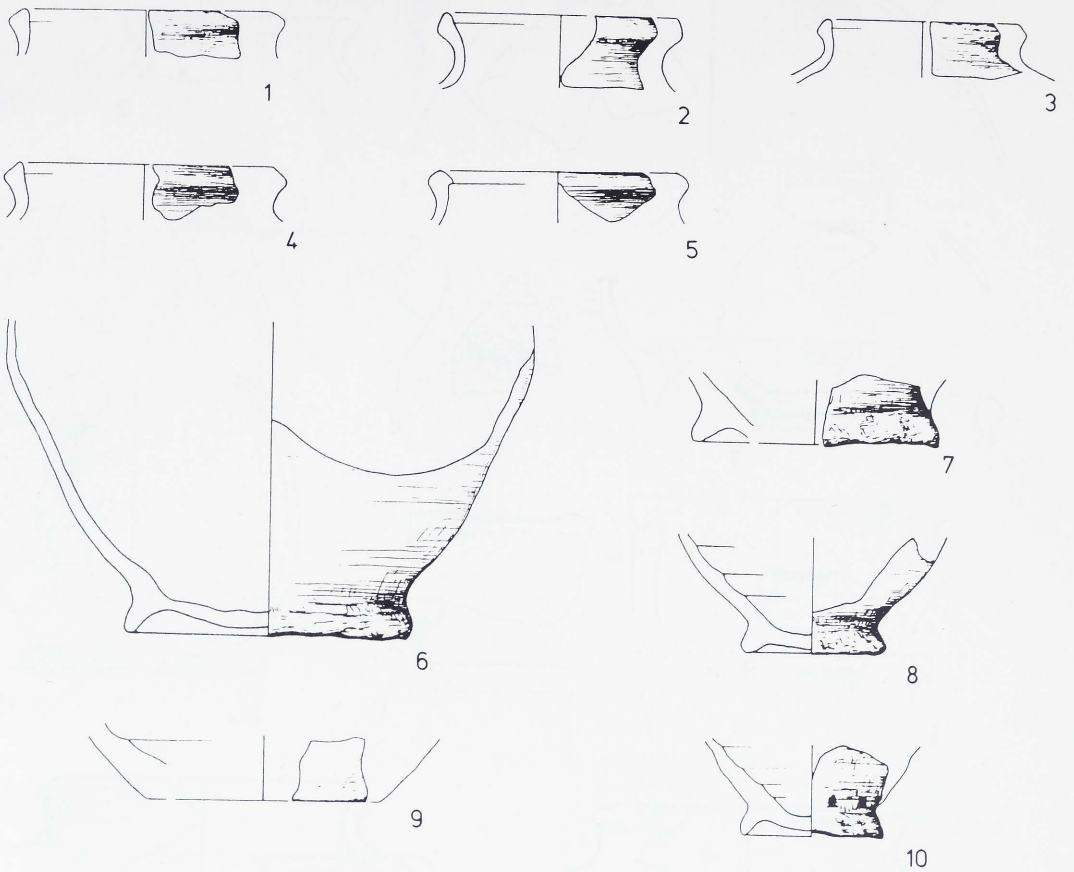

Tafel: 50
Maßstab: 1:3
Komplex: 34

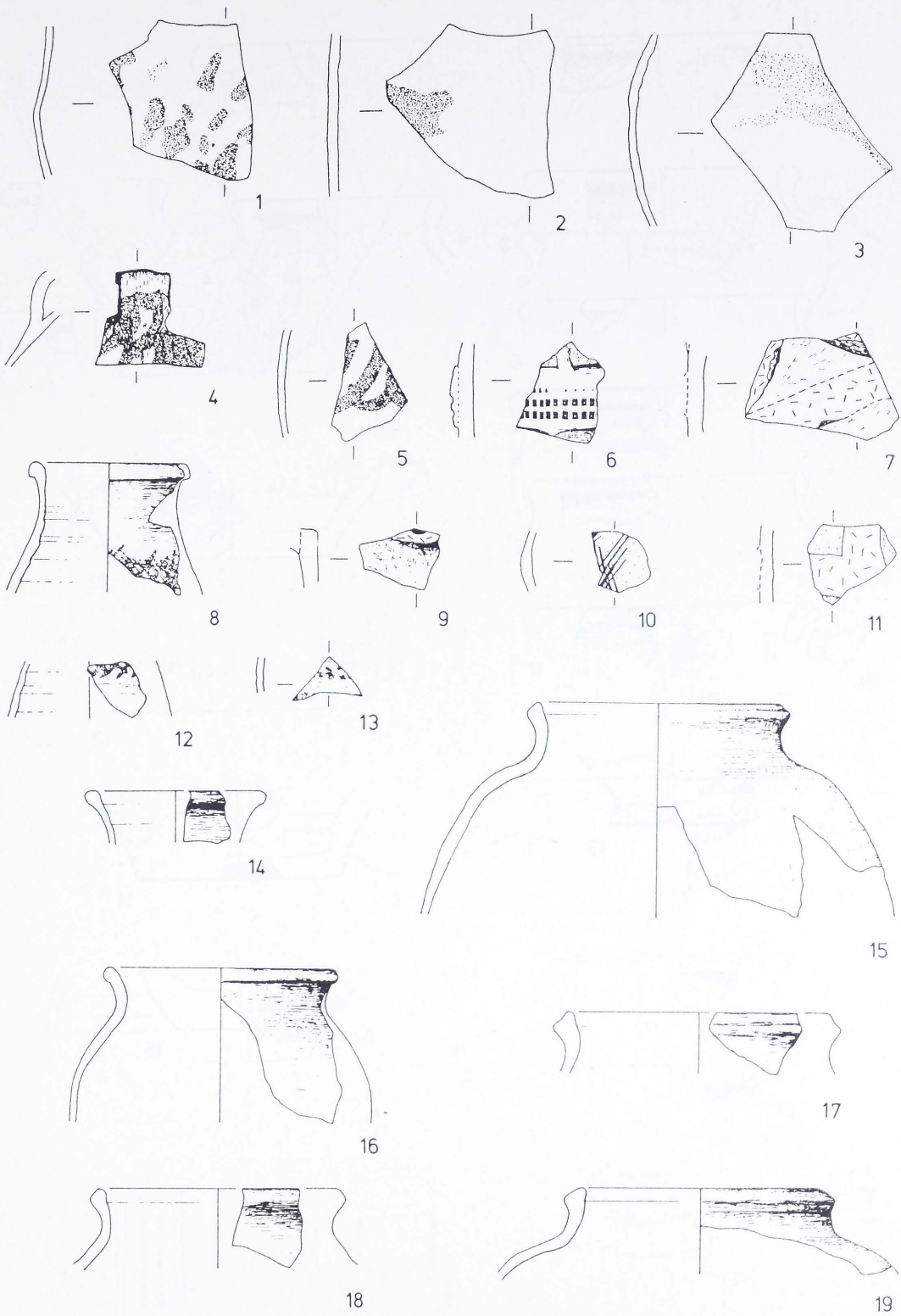

Tafel: 51
 Maßstab: 1:3
 Komplex: 36

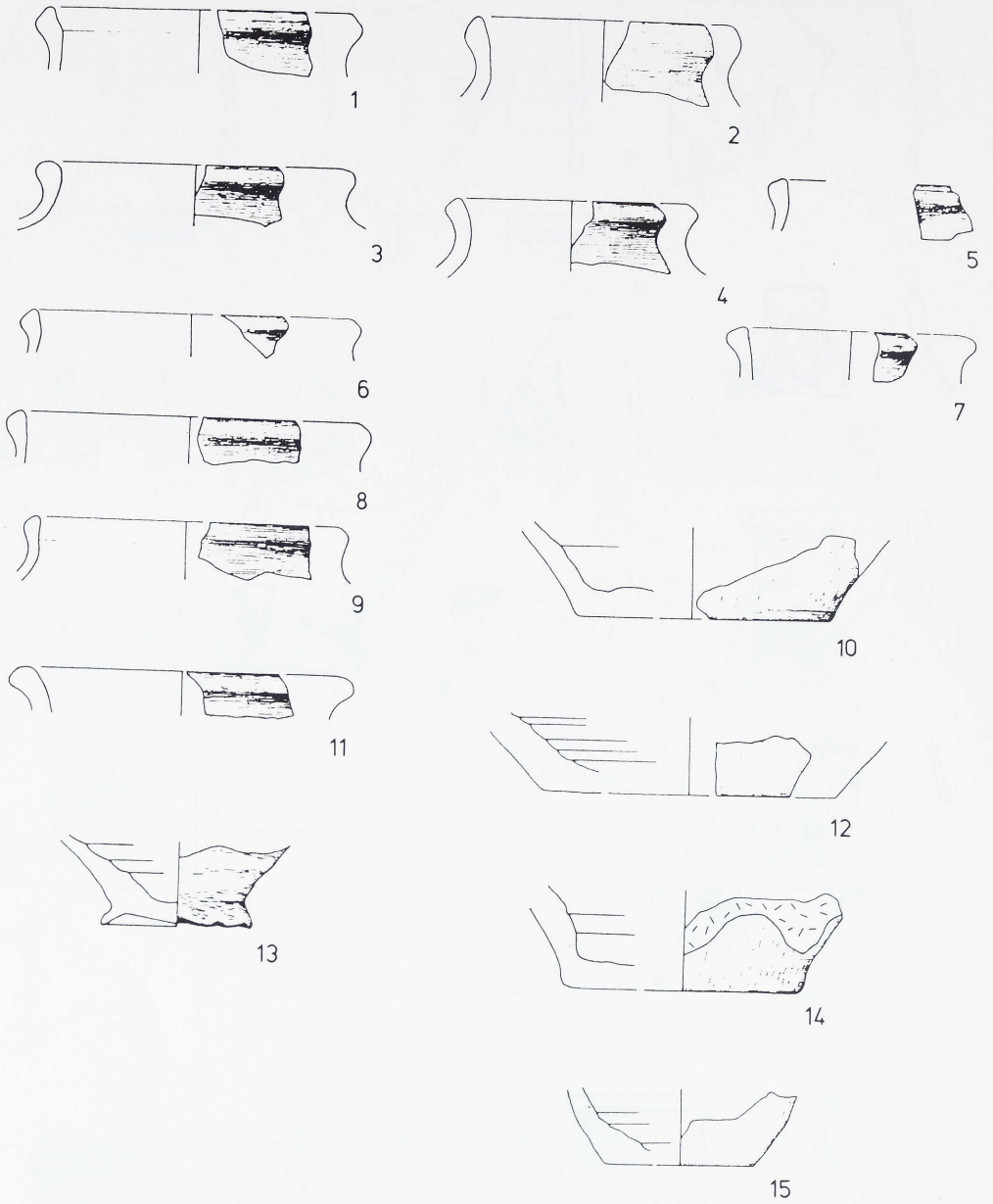

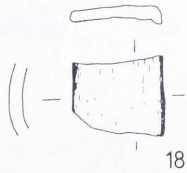
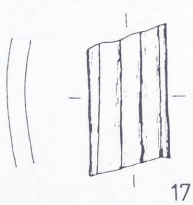
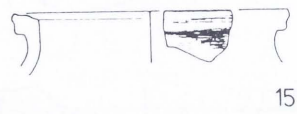
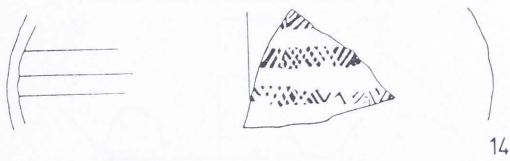
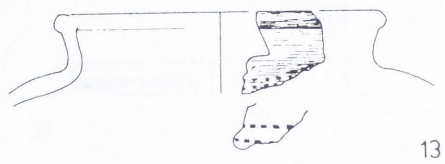
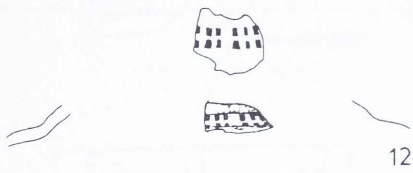
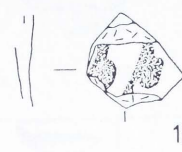
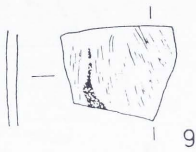
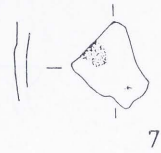
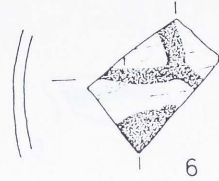
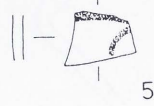
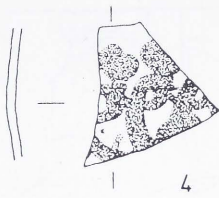
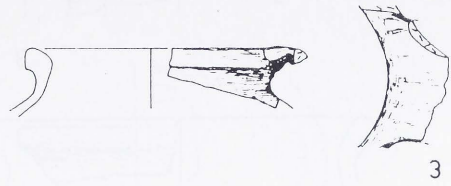
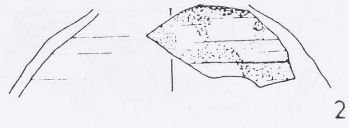
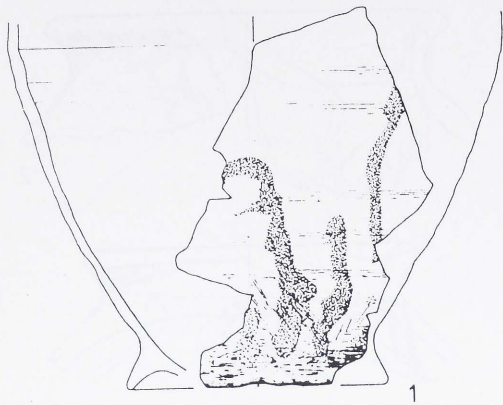

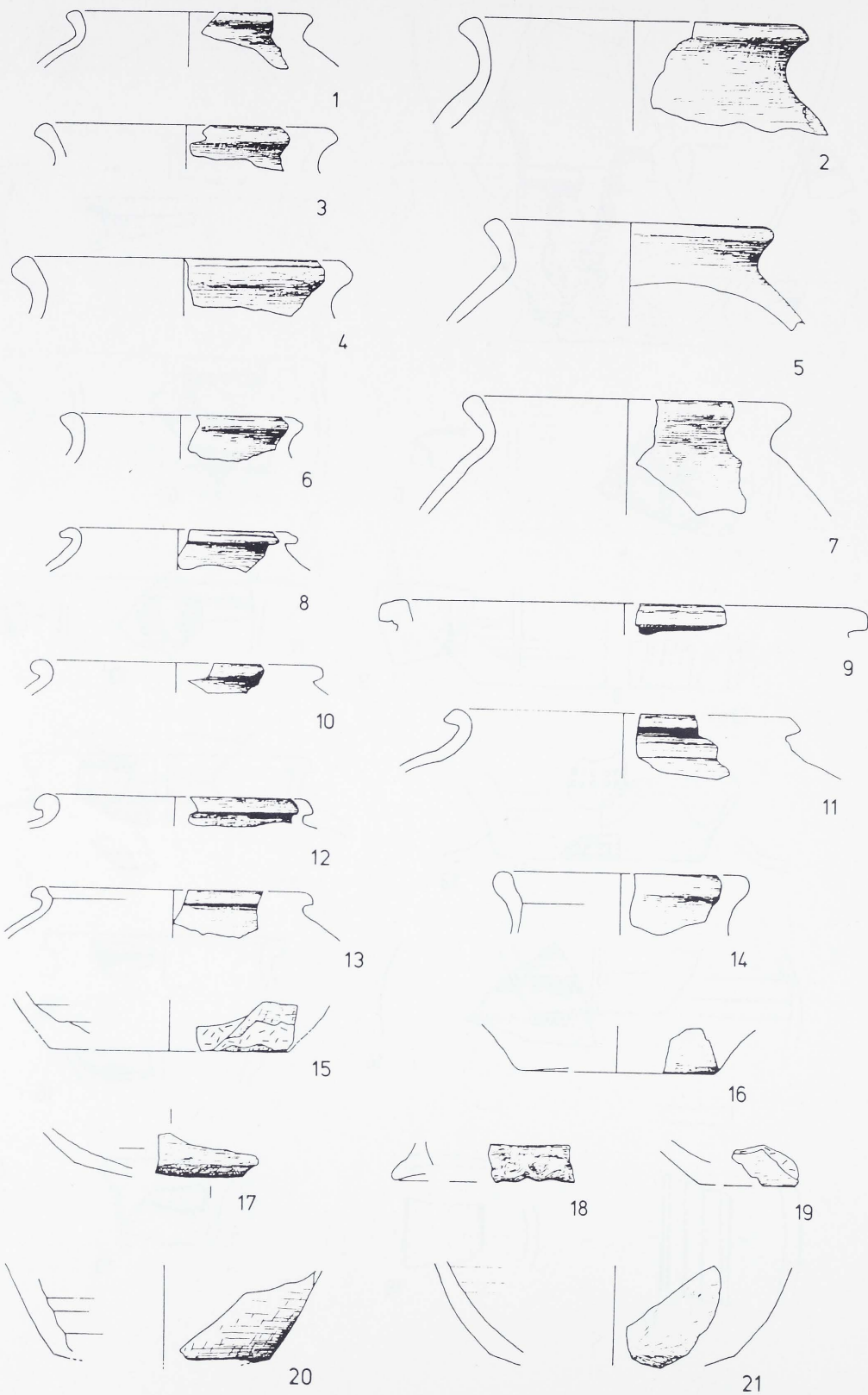

Tafel:54
 Maßstab: 1:3
 Komplex: 37

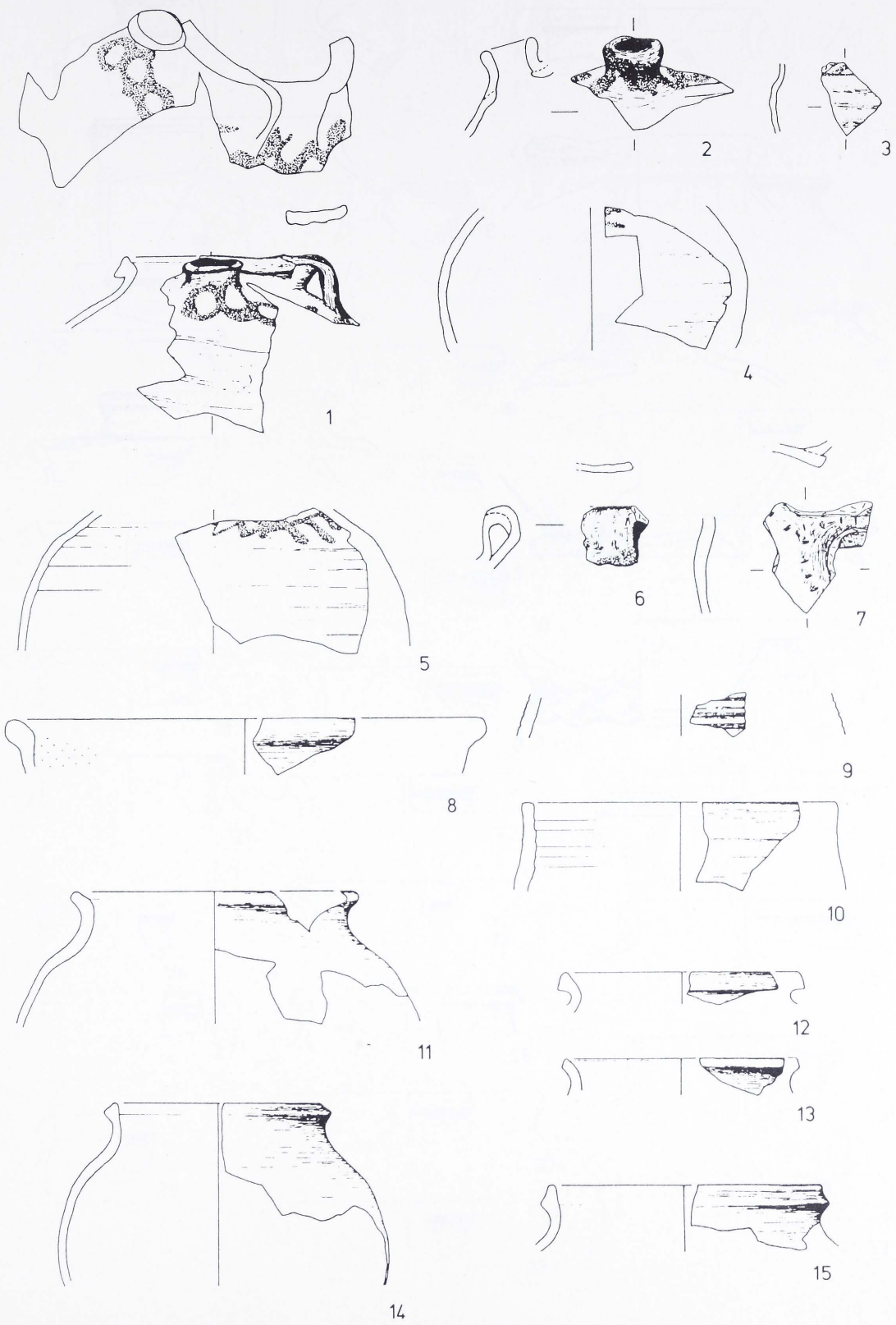

Tafel: 55
 Maßstab: 1:3
 Komplex: 38

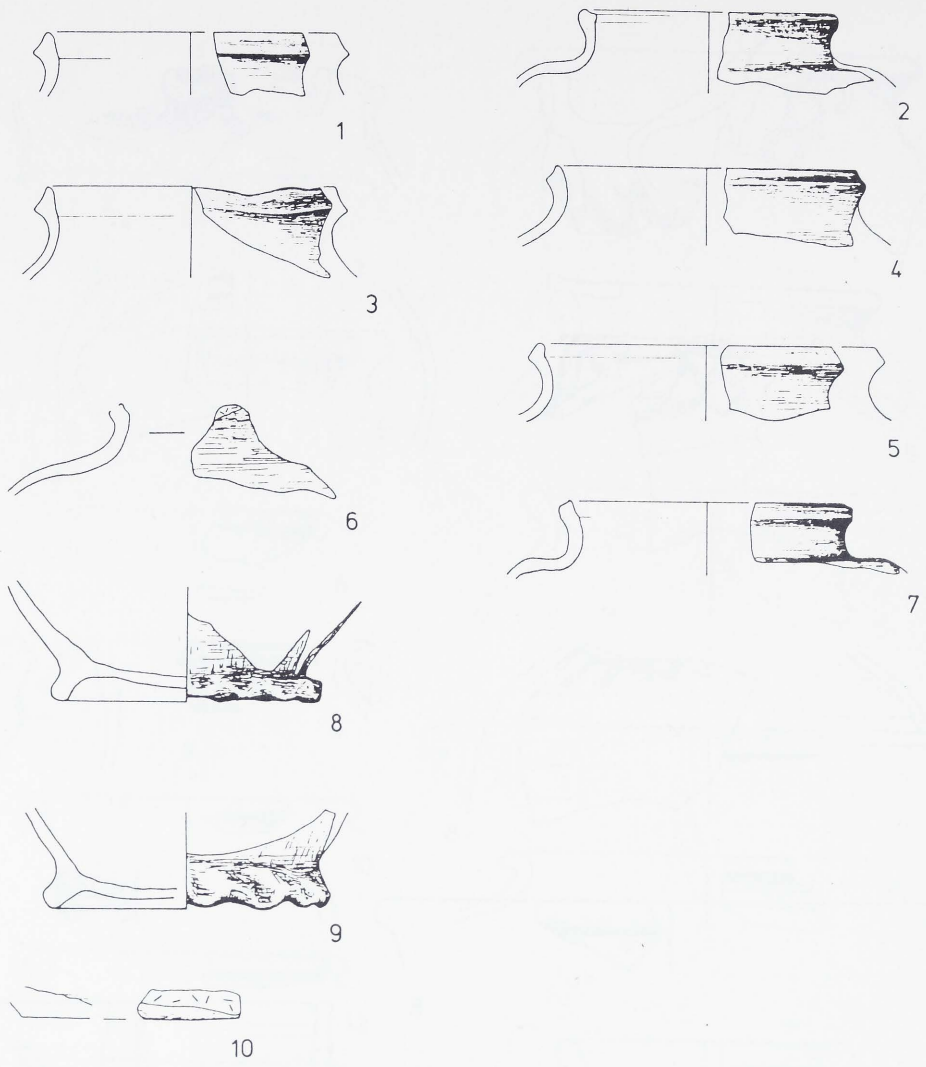

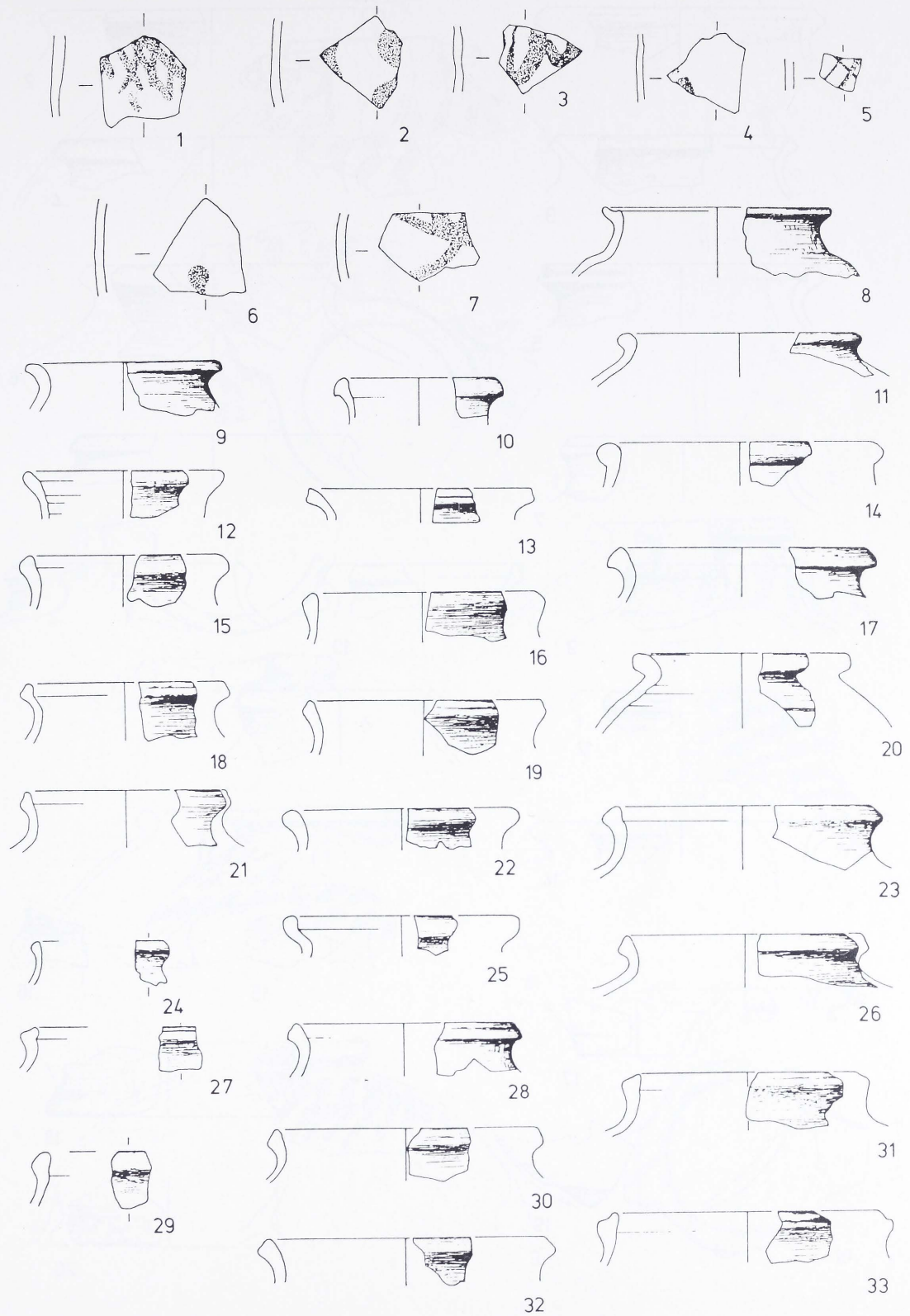

Tafel: 57
 Maßstab: 1:3
 Komplex: 40

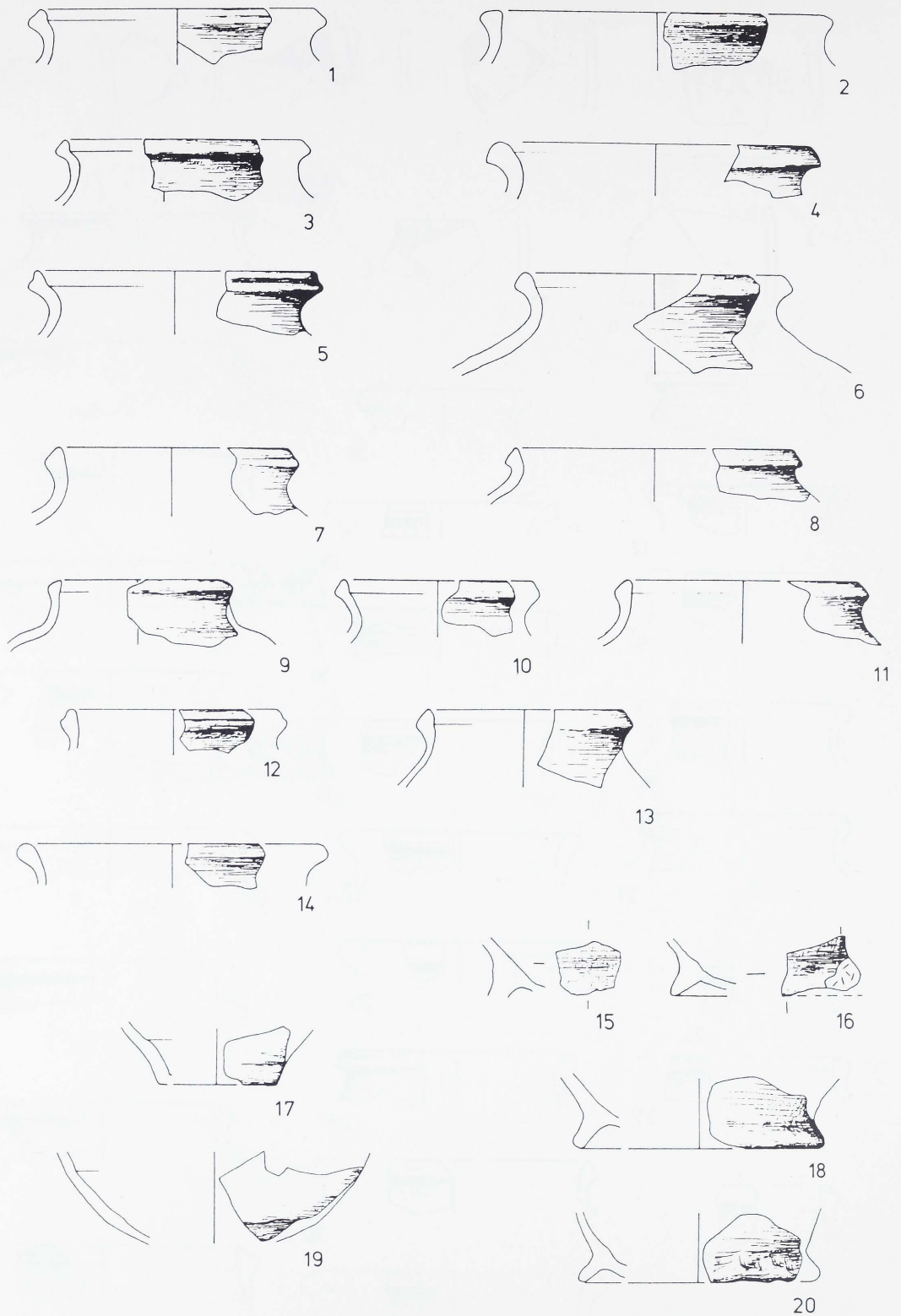

Tafel: 58
 Maßstab: 1:3
 Komplex: 40

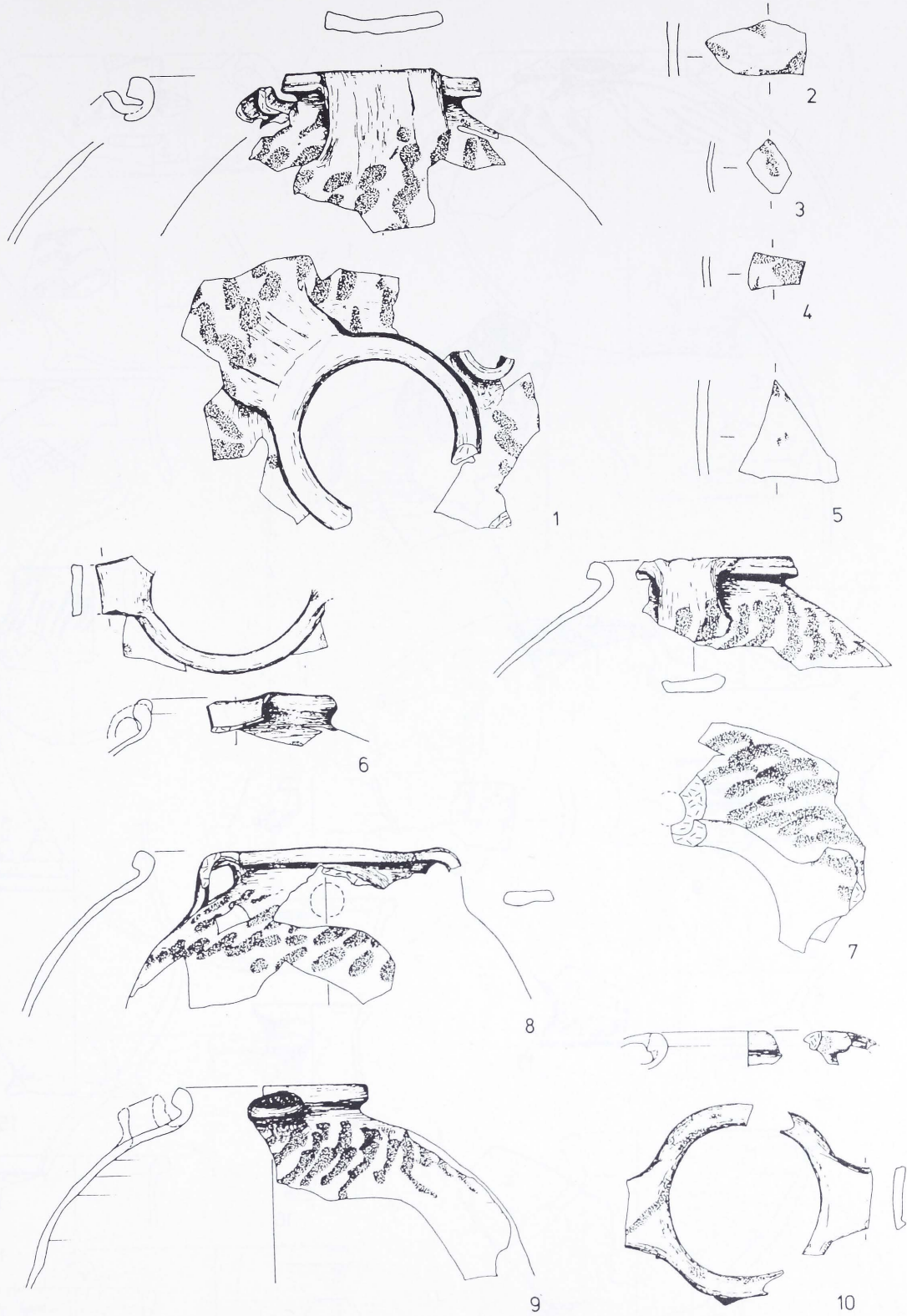

Tafel: 59
 Maßstab: 1:3
 Komplex: 41

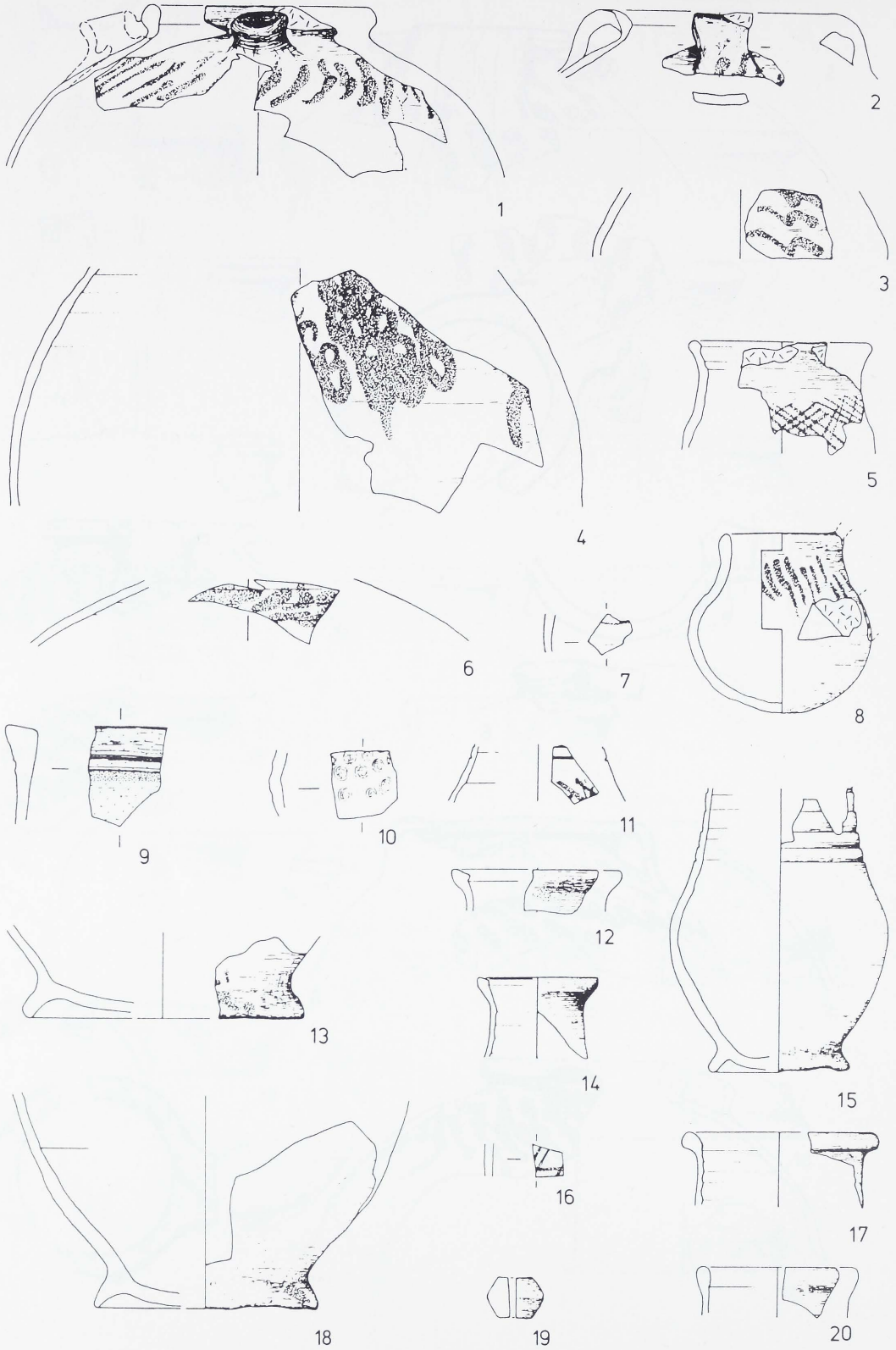

Tafel: 60
 Maßstab: 1:3
 Komplex: 41

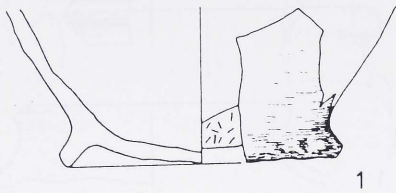

1

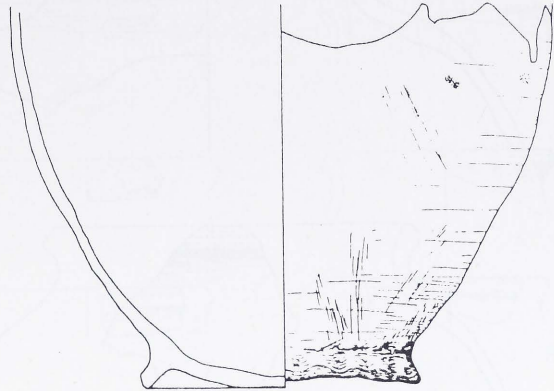

3

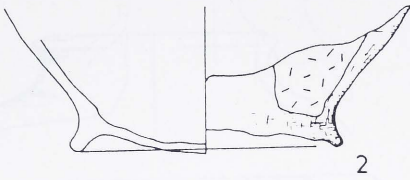

2

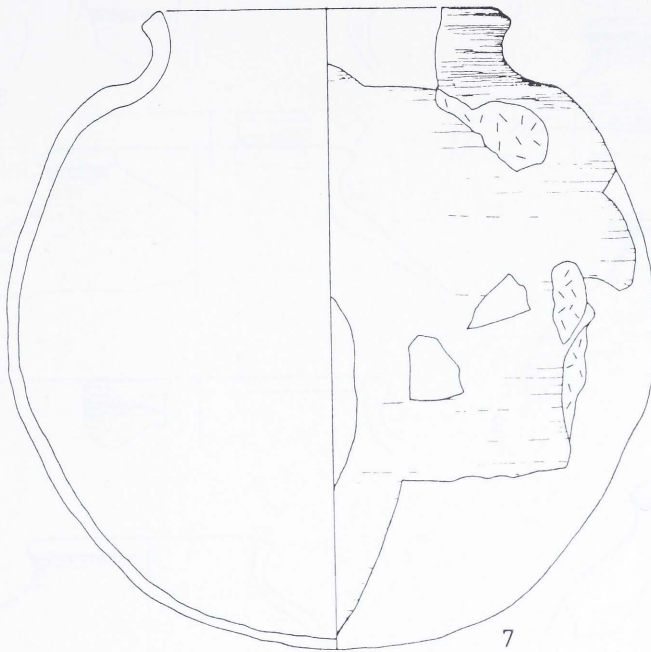

7



4

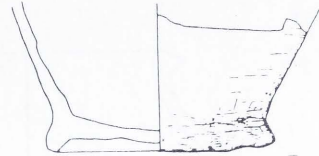

5

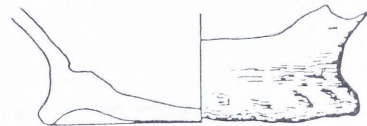

6



8



9



10

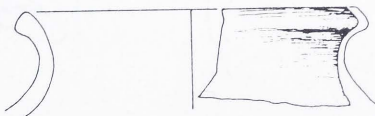

11

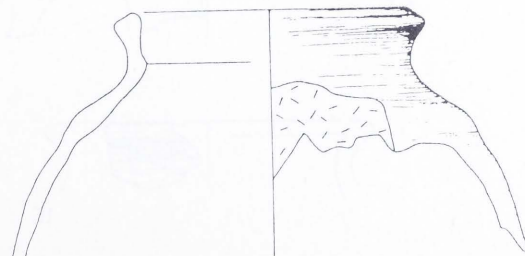

12

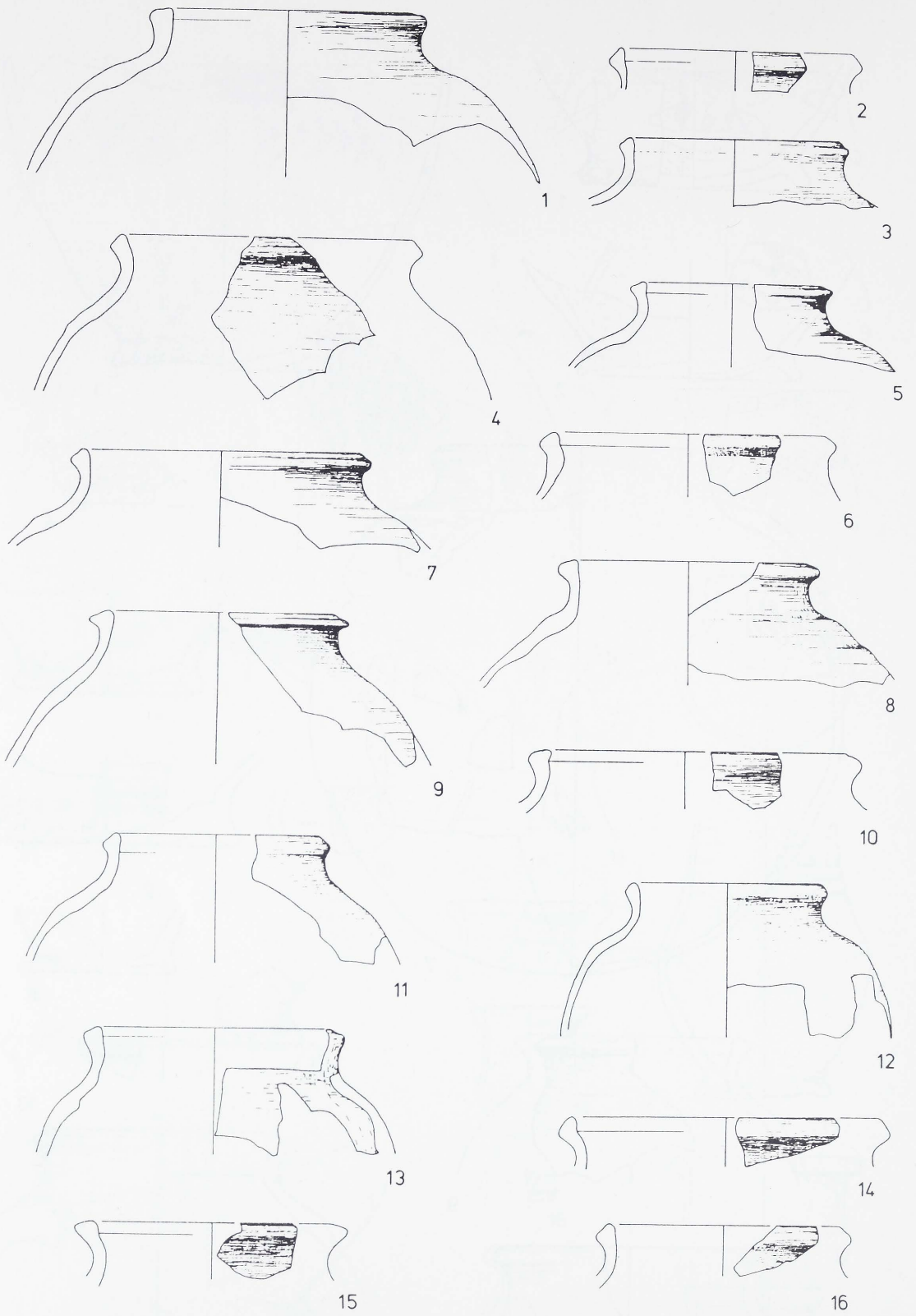

Tafel: 62
 Maßstab: 1:3
 Komplex: 41

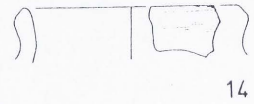
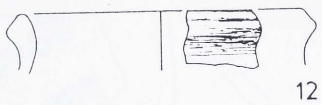
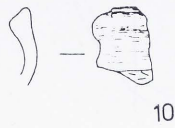
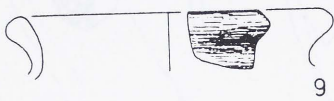
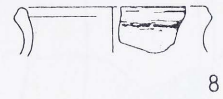
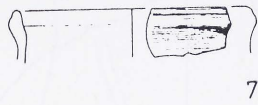
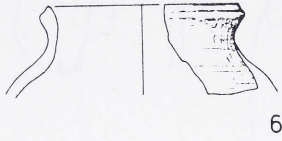
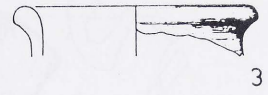
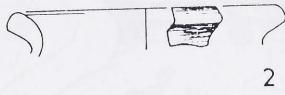
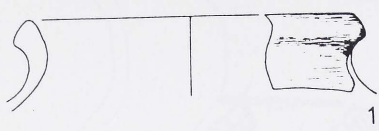

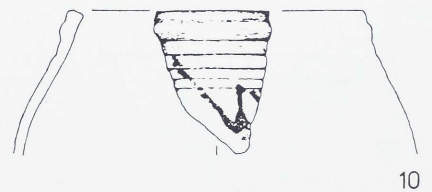
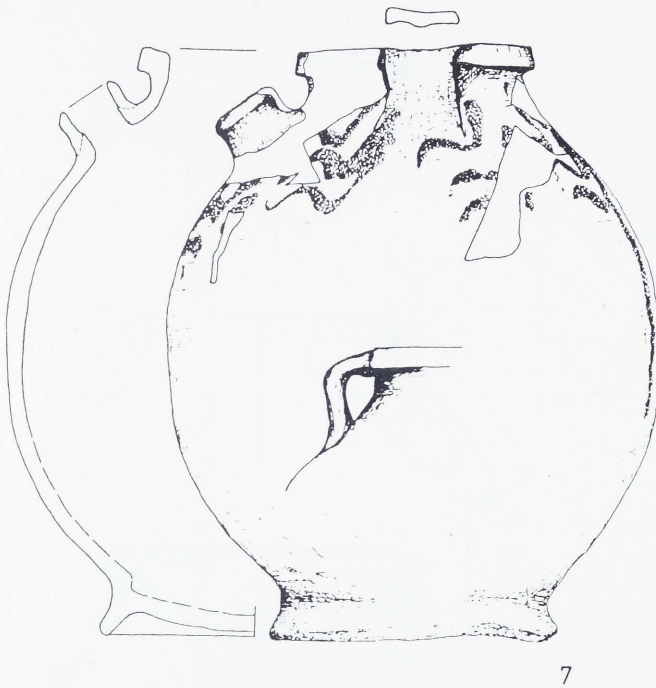
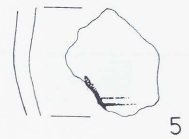
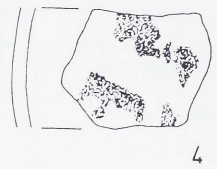
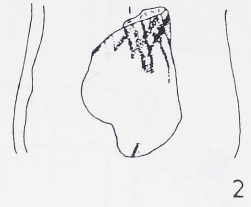
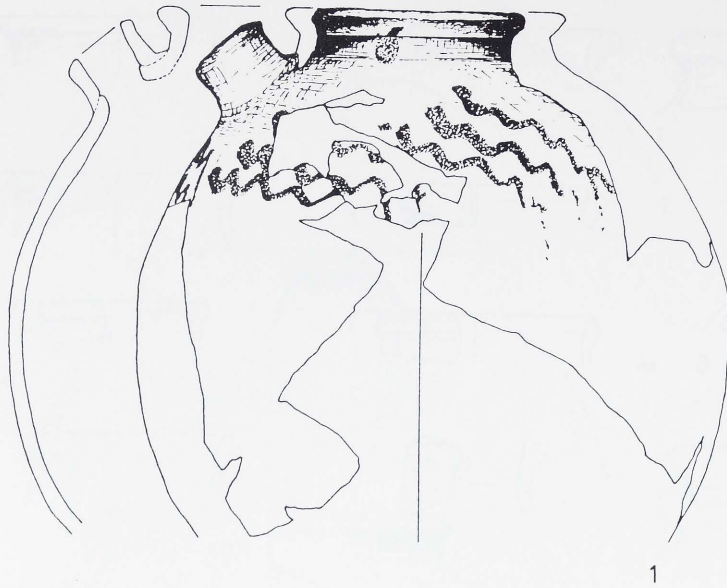

Tafel: 64
Maßstab: 1:3
Komplex: 42

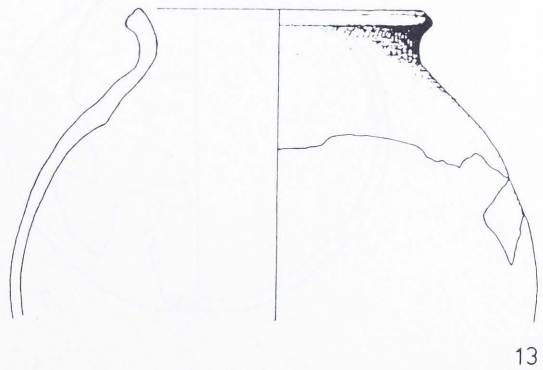
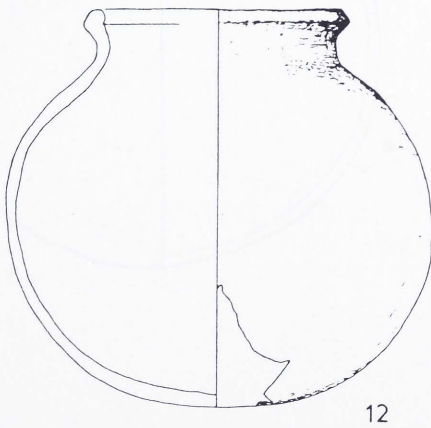
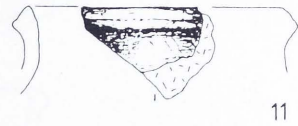
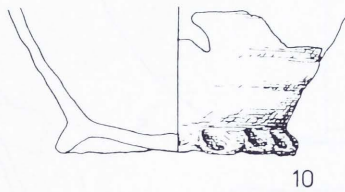
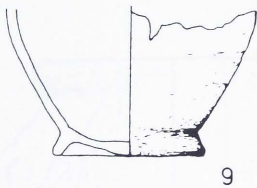
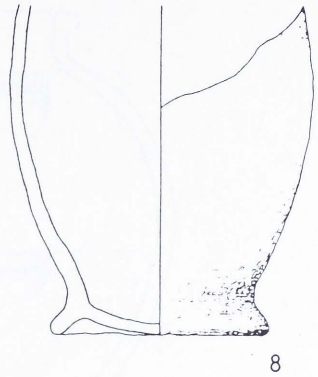
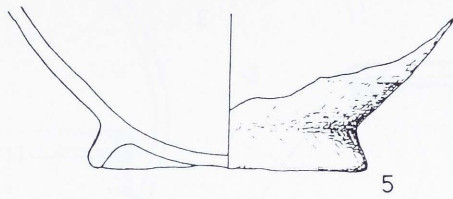
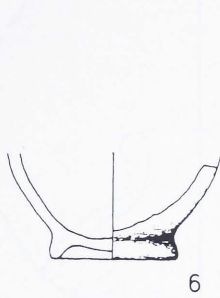
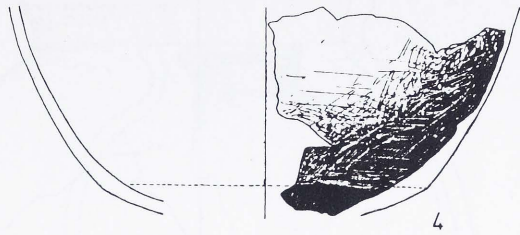
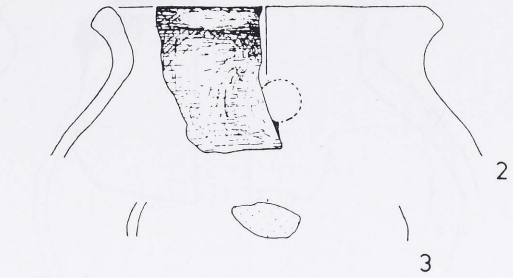
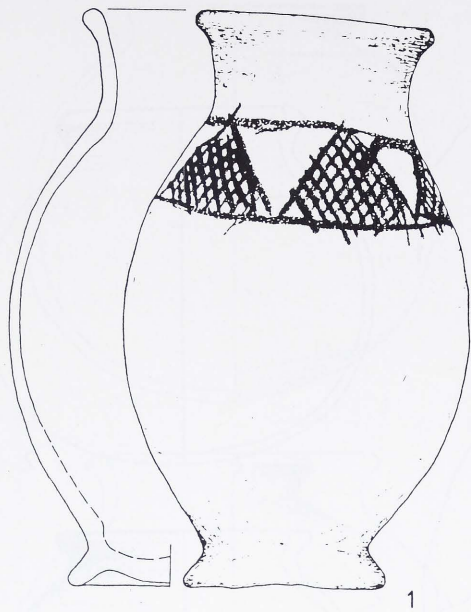

Tafel: 65
Maßstab: 1:3
Komplex: 42

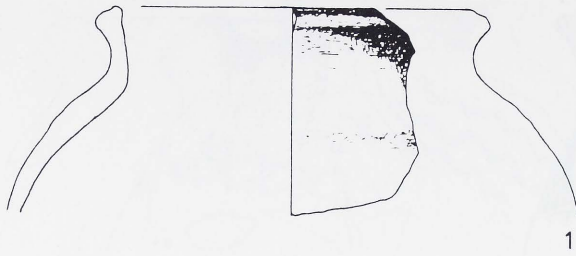

1

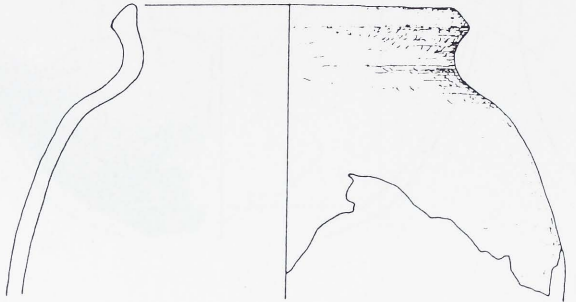

3

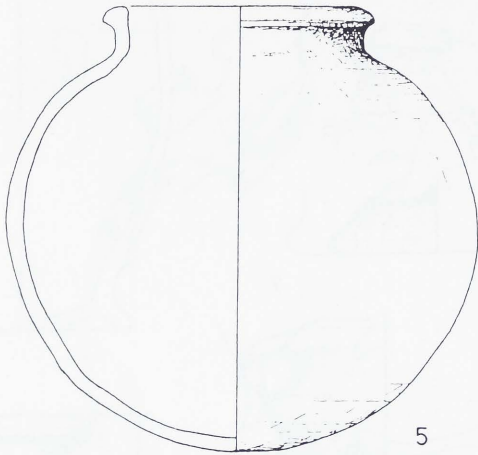

5

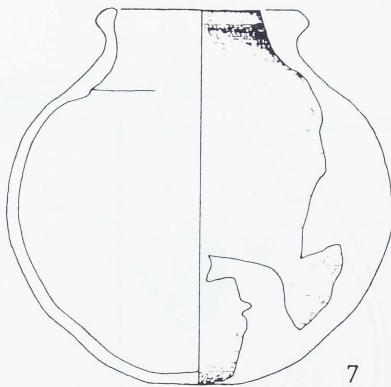

7

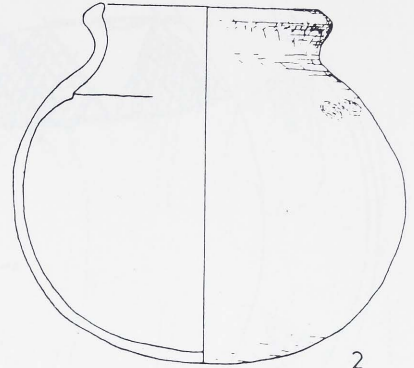

2

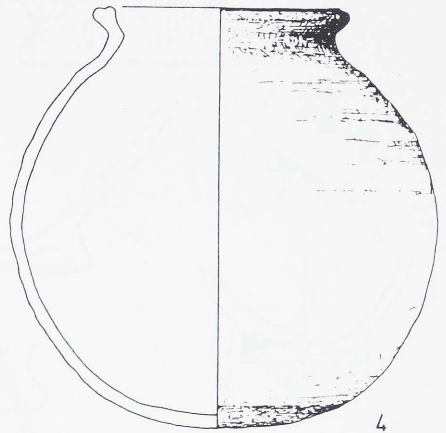

4

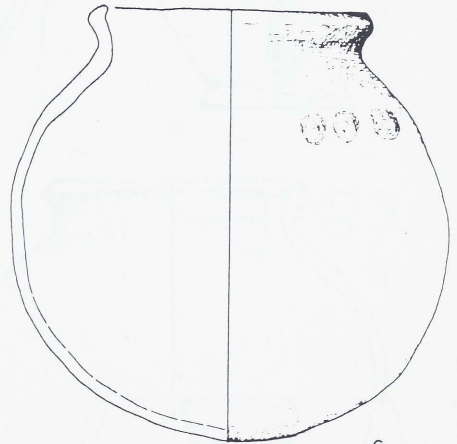

6

Tafel: 66
Maßstab: 1:3
Komplex: 42

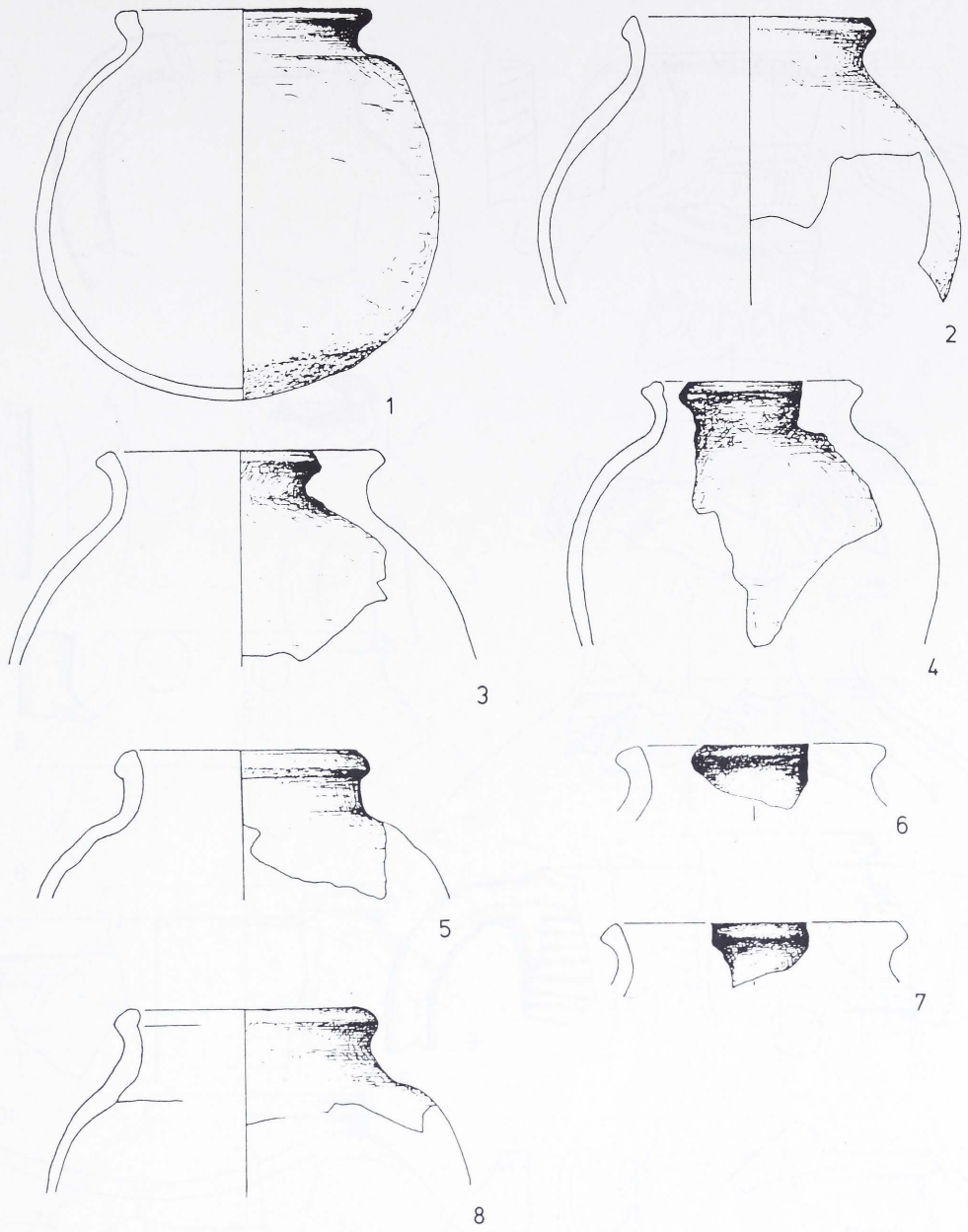

Tafel: 67
Maßstab: 1:3
Komplex: 42

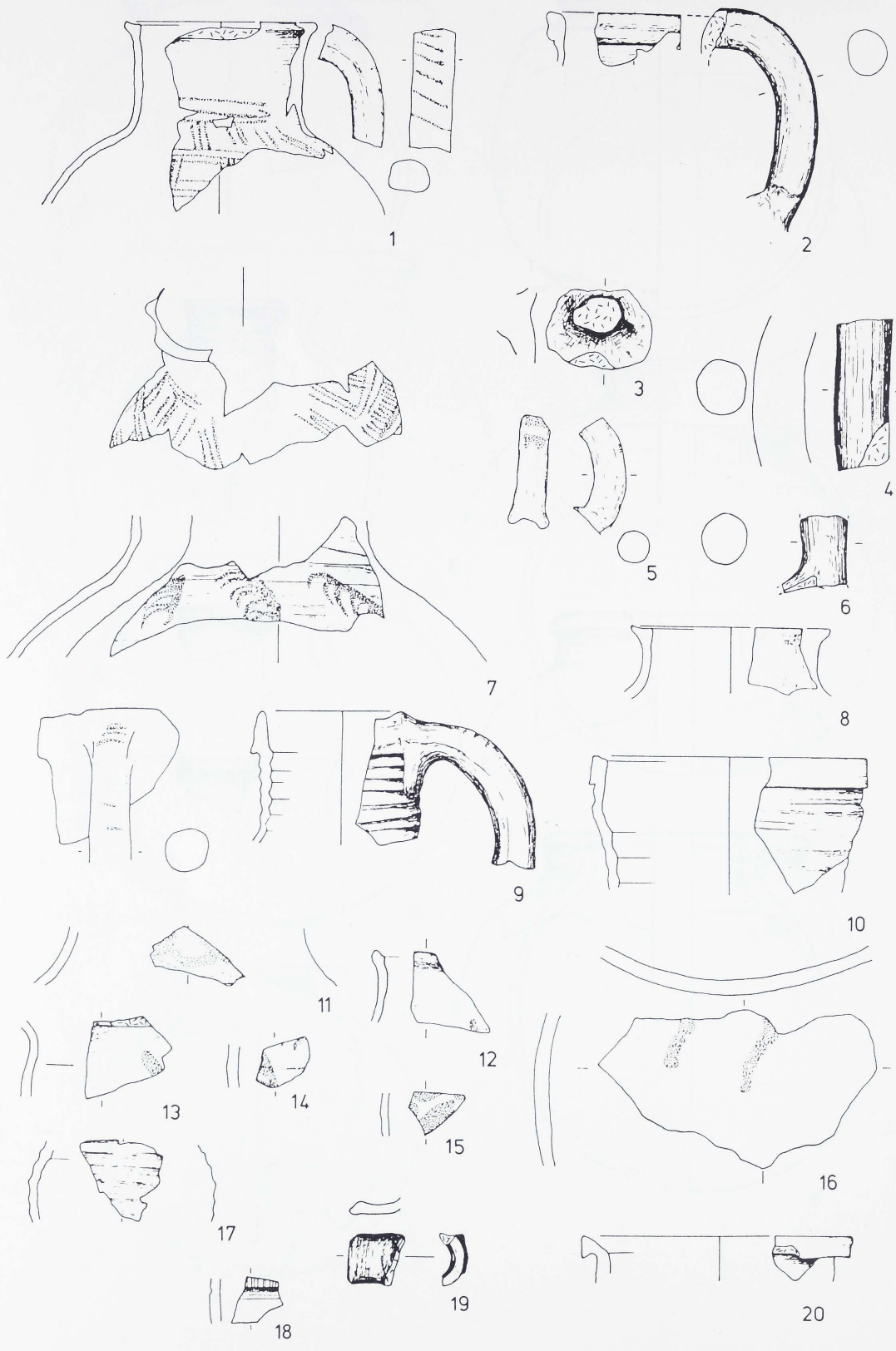

Tafel: 68
 Maßstab: 1:3
 Komplex: 43

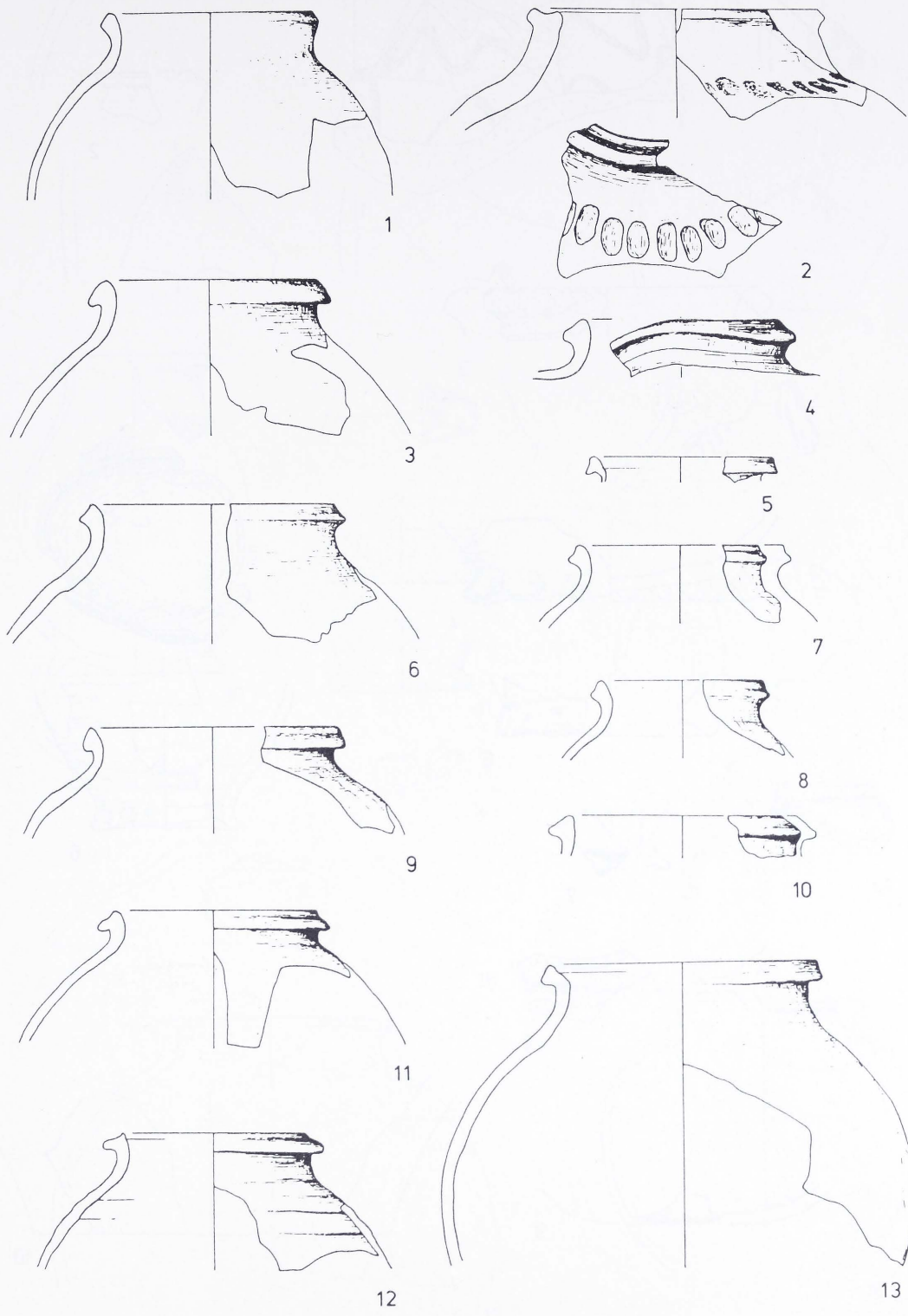

Tafel: 69
 Maßstab: 1:3
 Komplex: 43

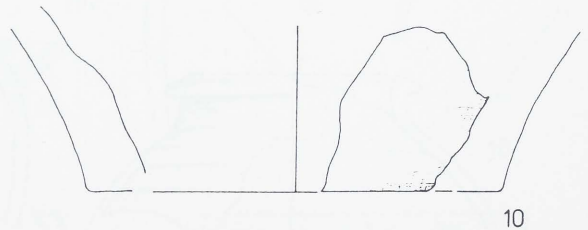
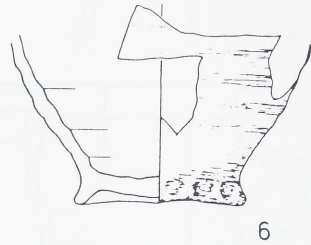
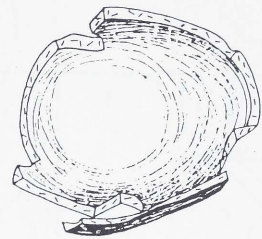
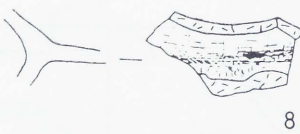
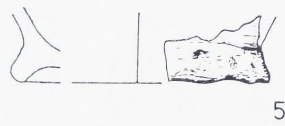
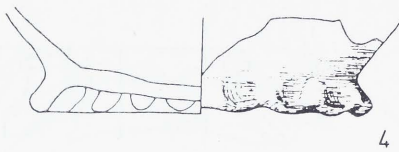
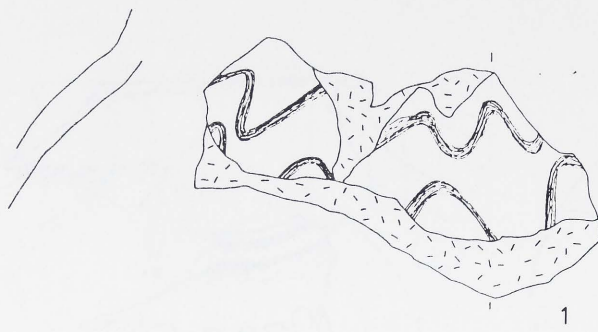

Tafel: 70
Maßstab: 1:3
Komplex: 43

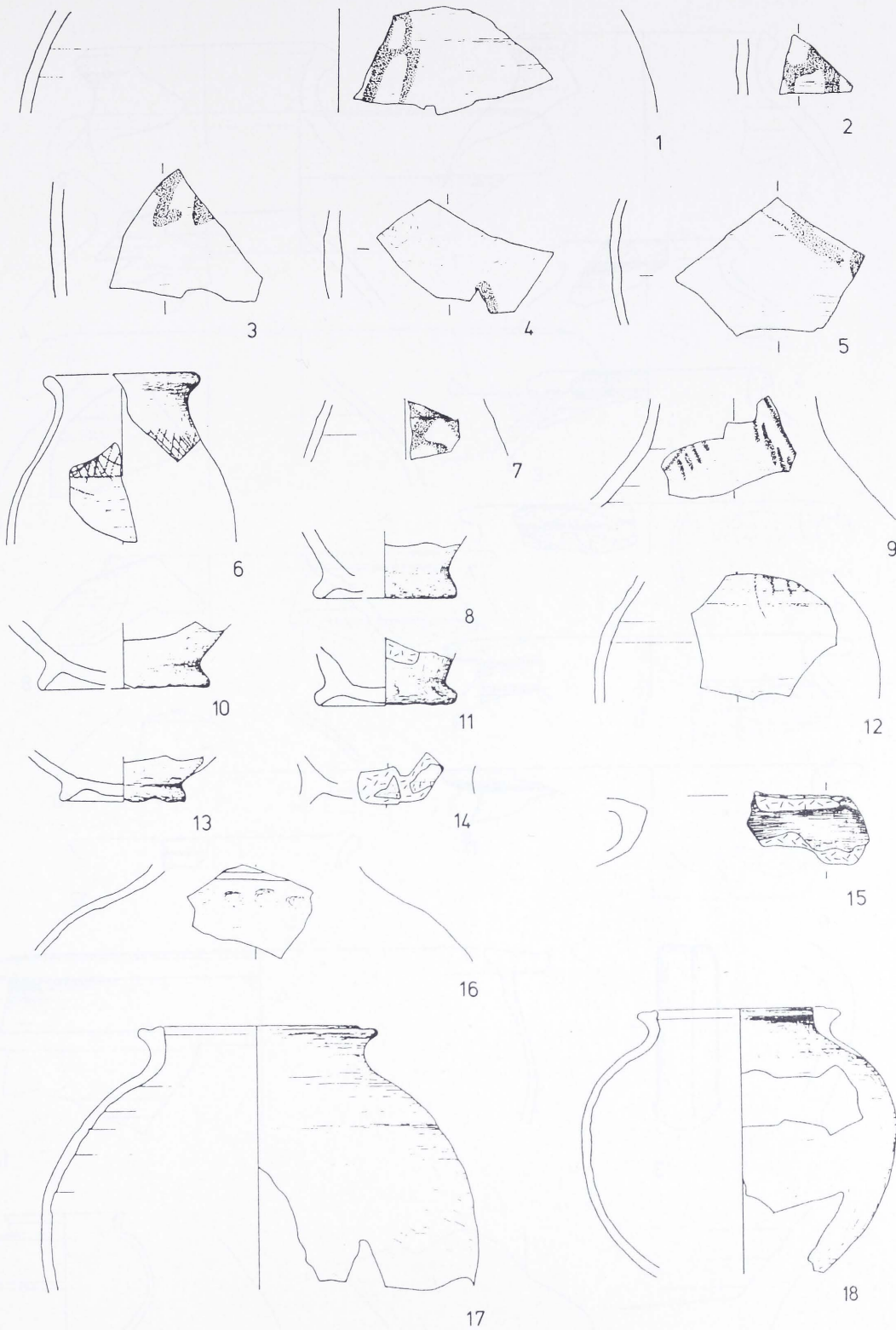

Tafel: 71
 Maßstab: 1:3
 Komplex: 44

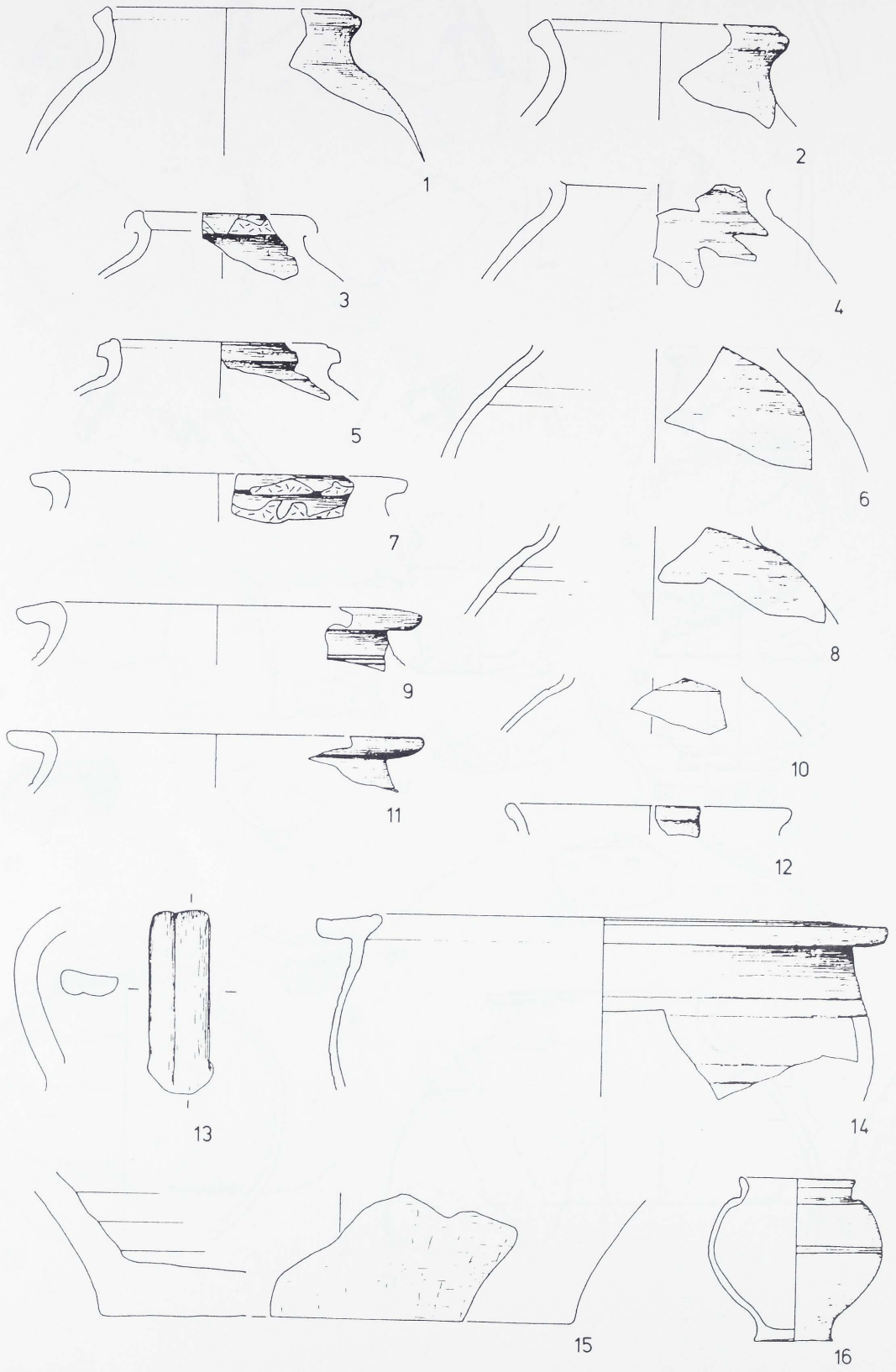

Tafel: 72
 Maßstab: 1:3
 Komplex: 44

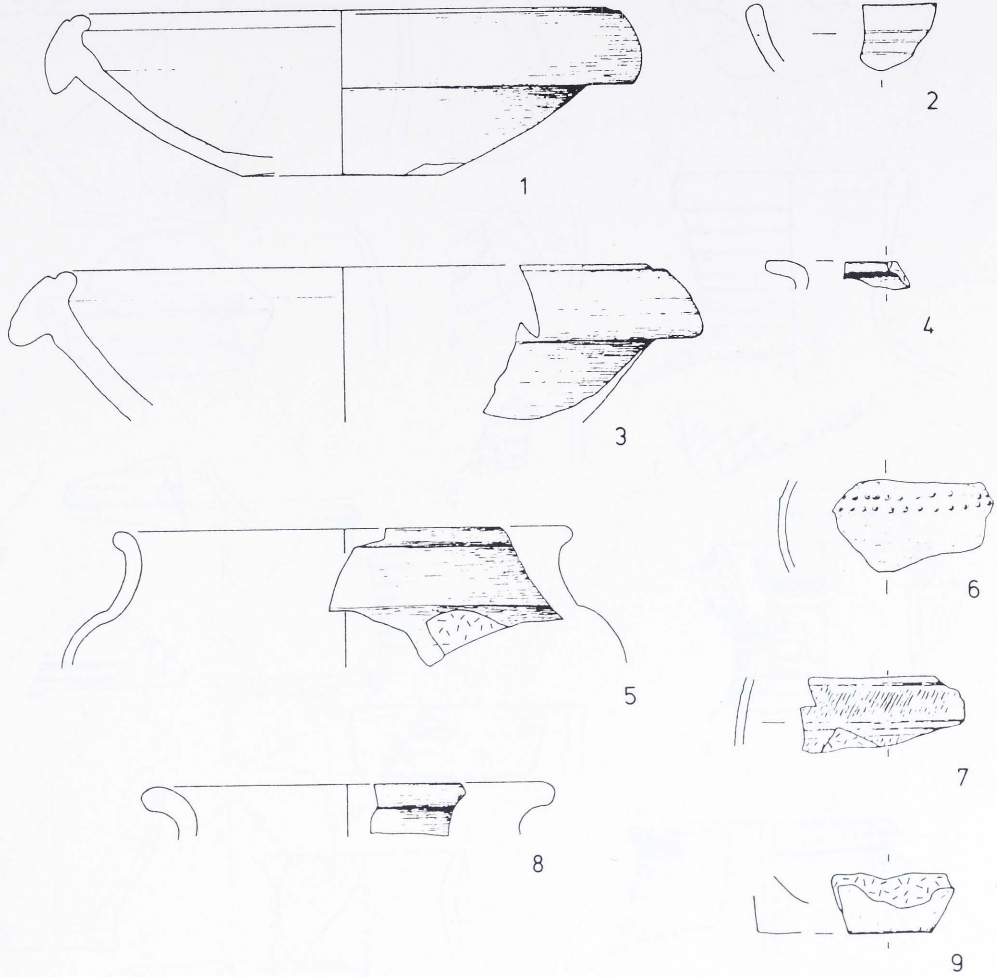

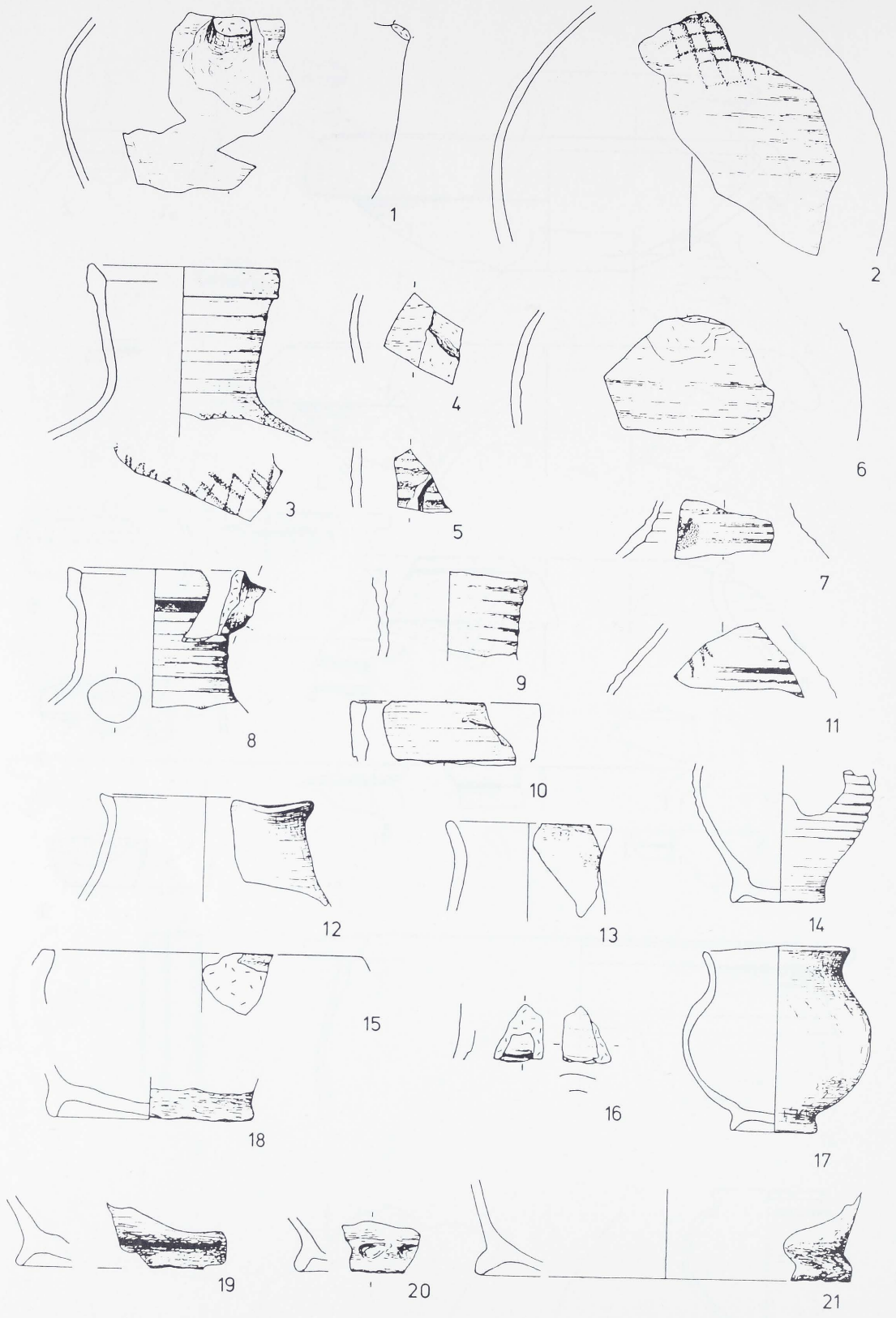

Tafel: 74
 Maßstab: 1:3
 Komplex: 46

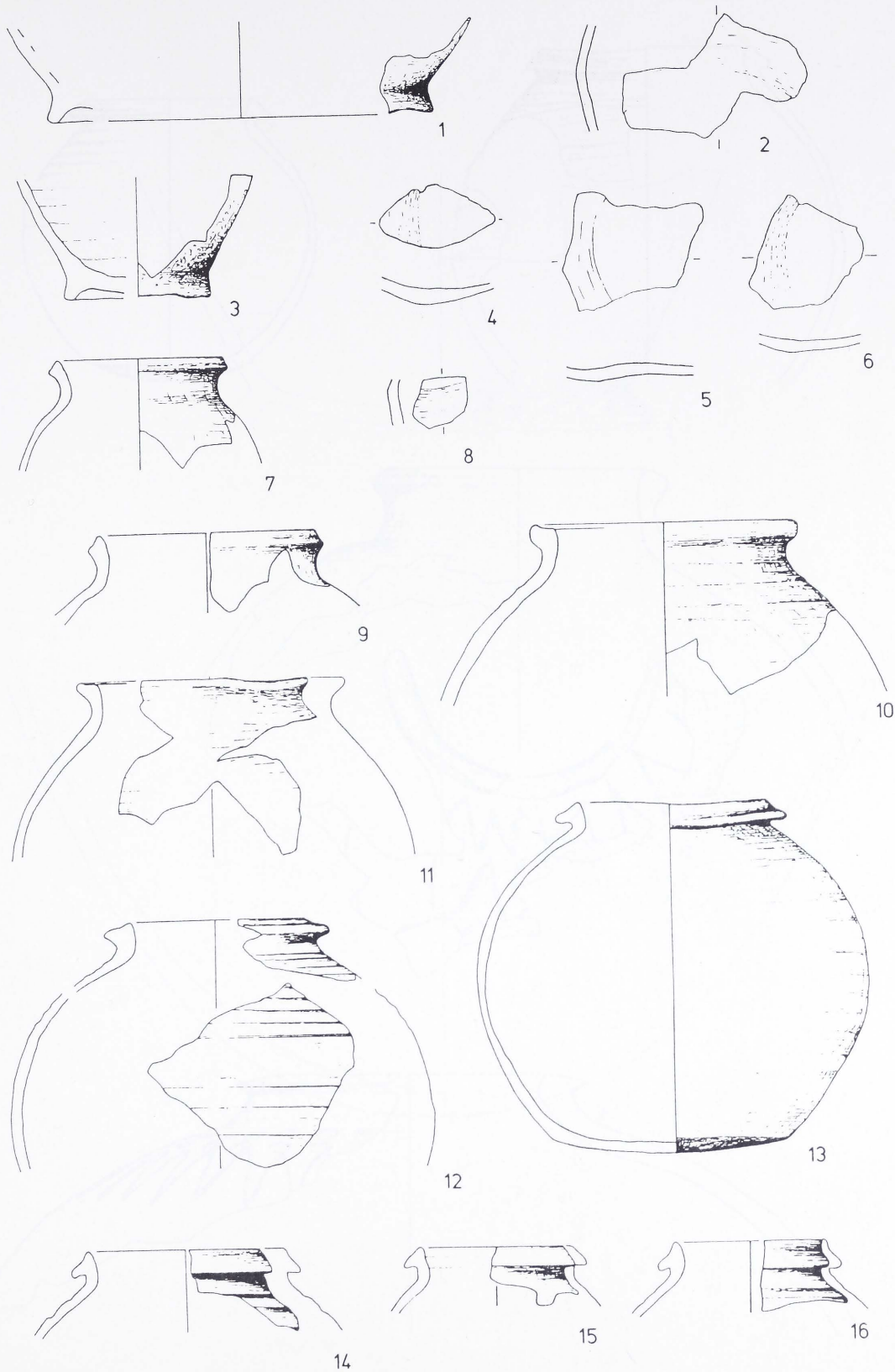

Tafel: 75
 Maßstab: 1:3
 Komplex: 46

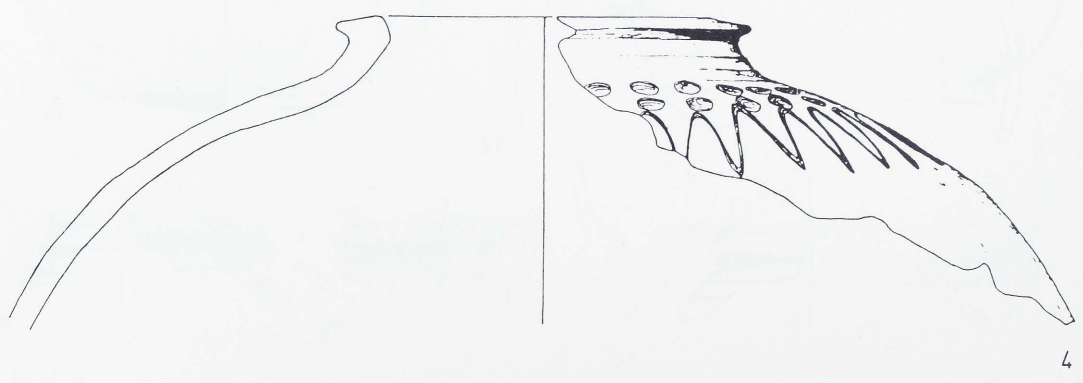
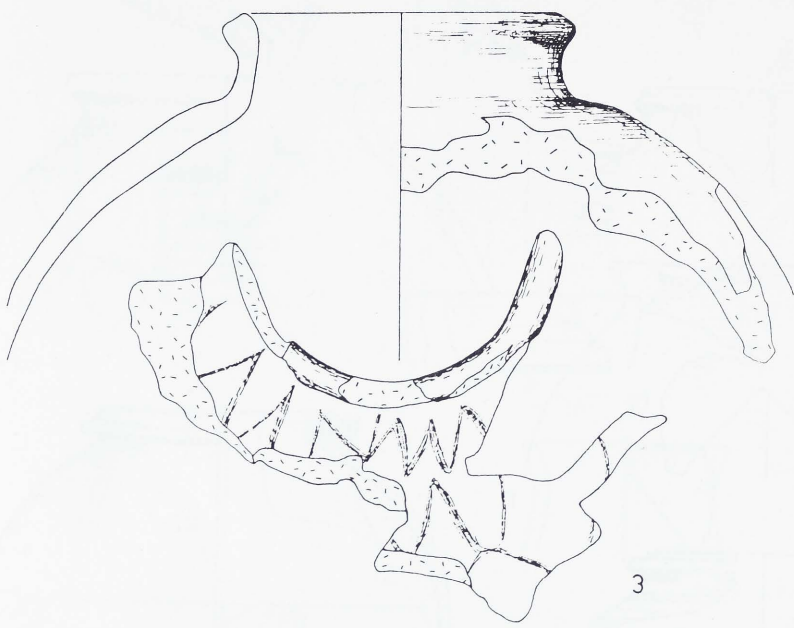
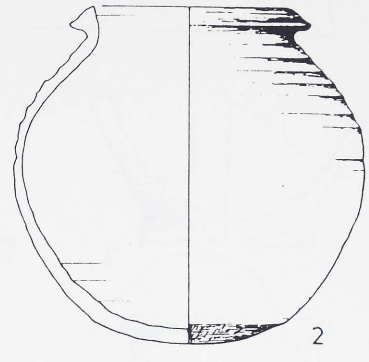
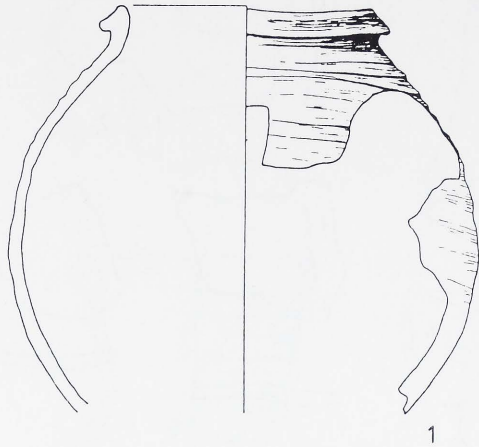

Tafel: 76
Maßstab: 1:3
Komplex: 46

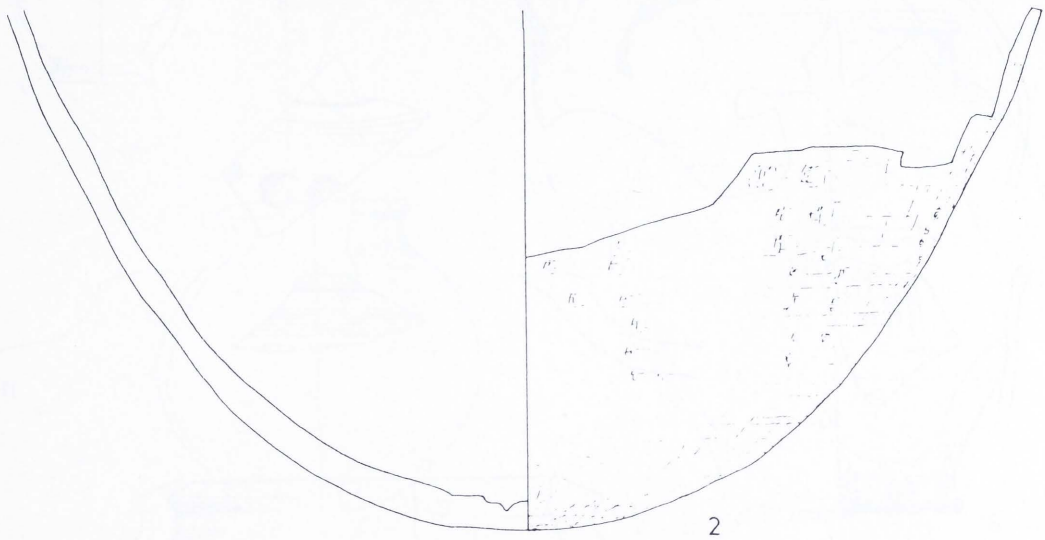
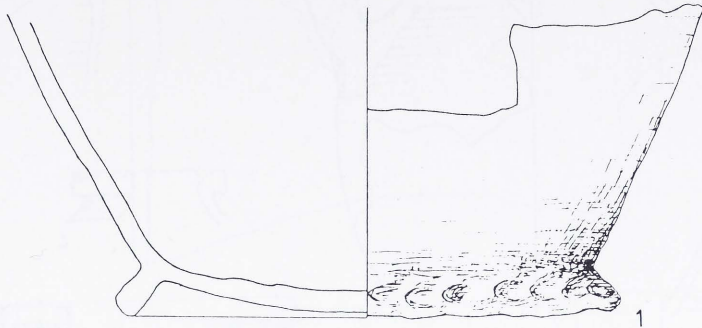

Tafel: 77
Maßstab: 1:3
Komplex: 46

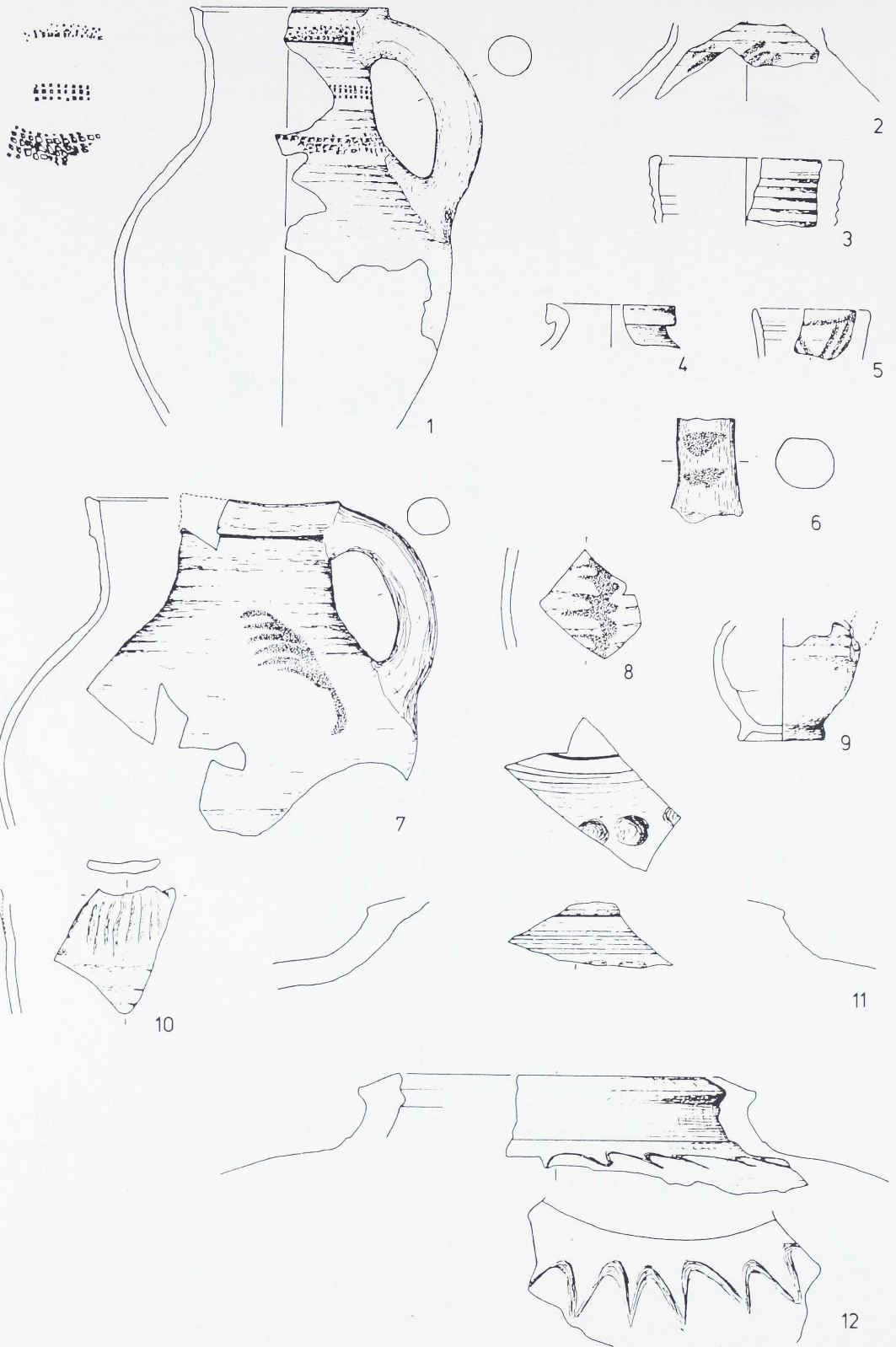

Tafel: 78
 Maßstab: 1:3
 Komplex: 47

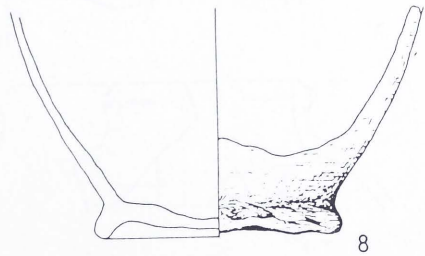
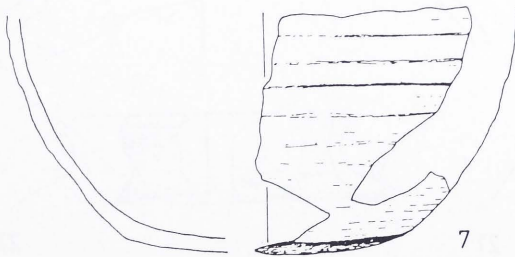
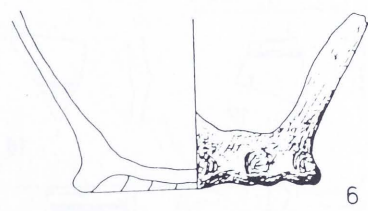
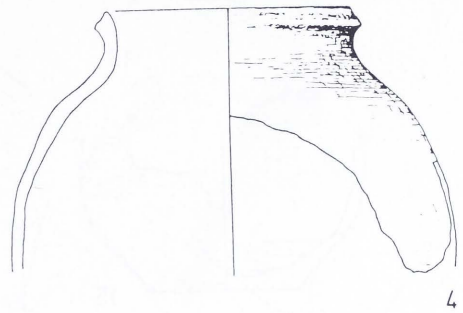
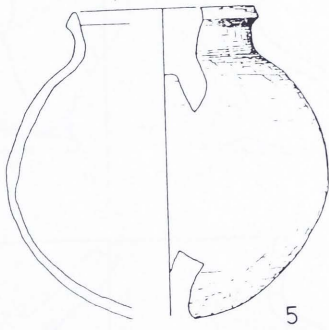
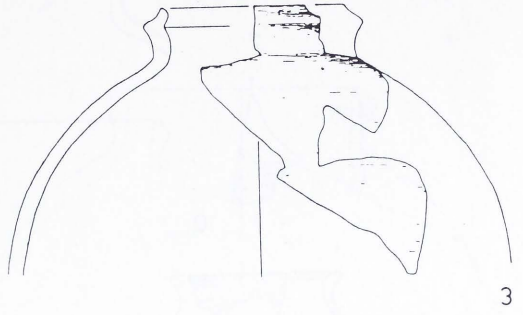
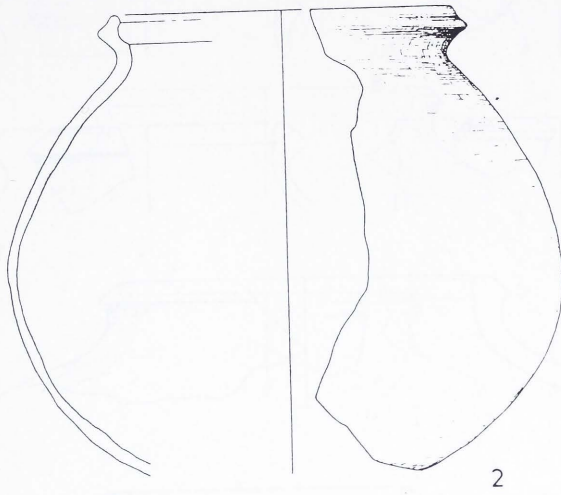
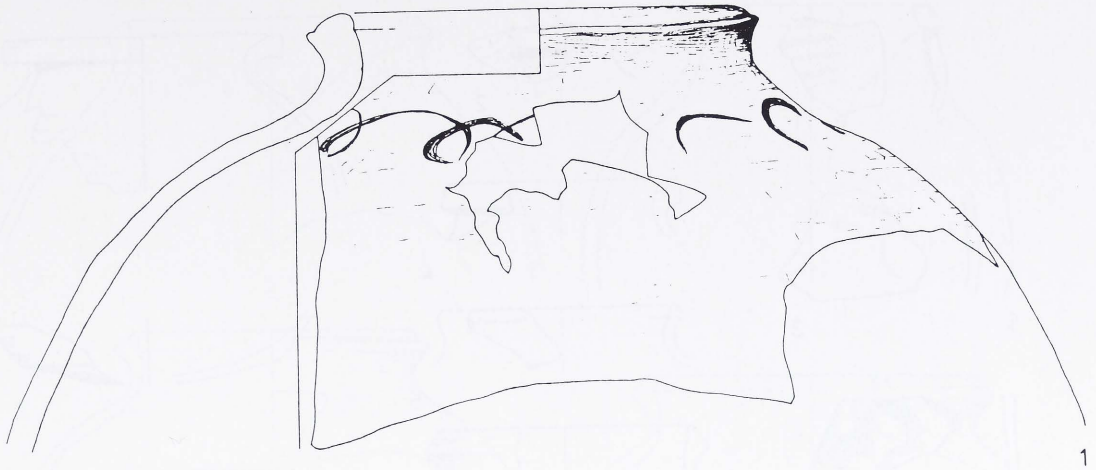

Tafel: 79
Maßstab: 1:3
Komplex: 47

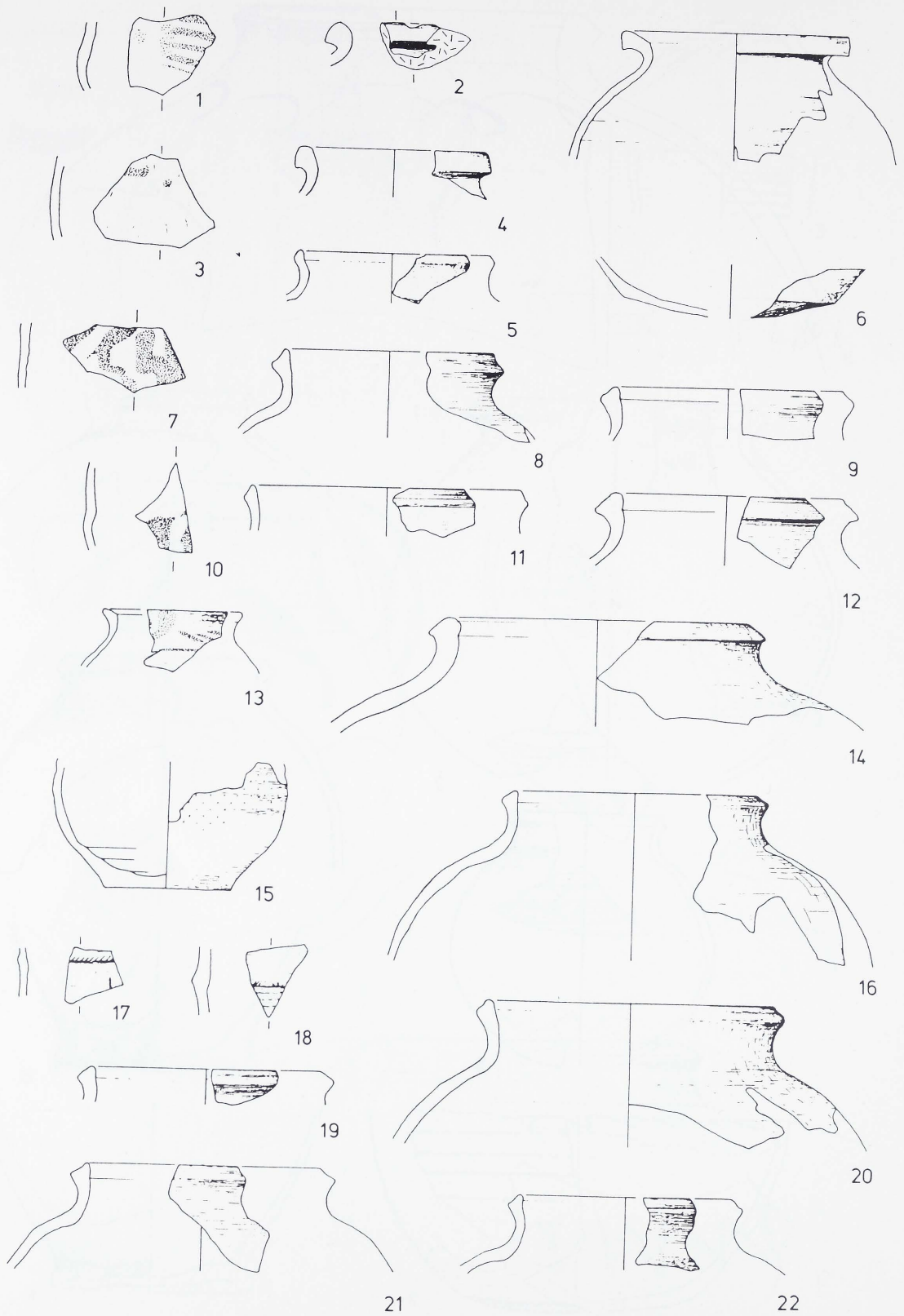

Tafel: 80
 Maßstab: 1:3
 Komplex: 48

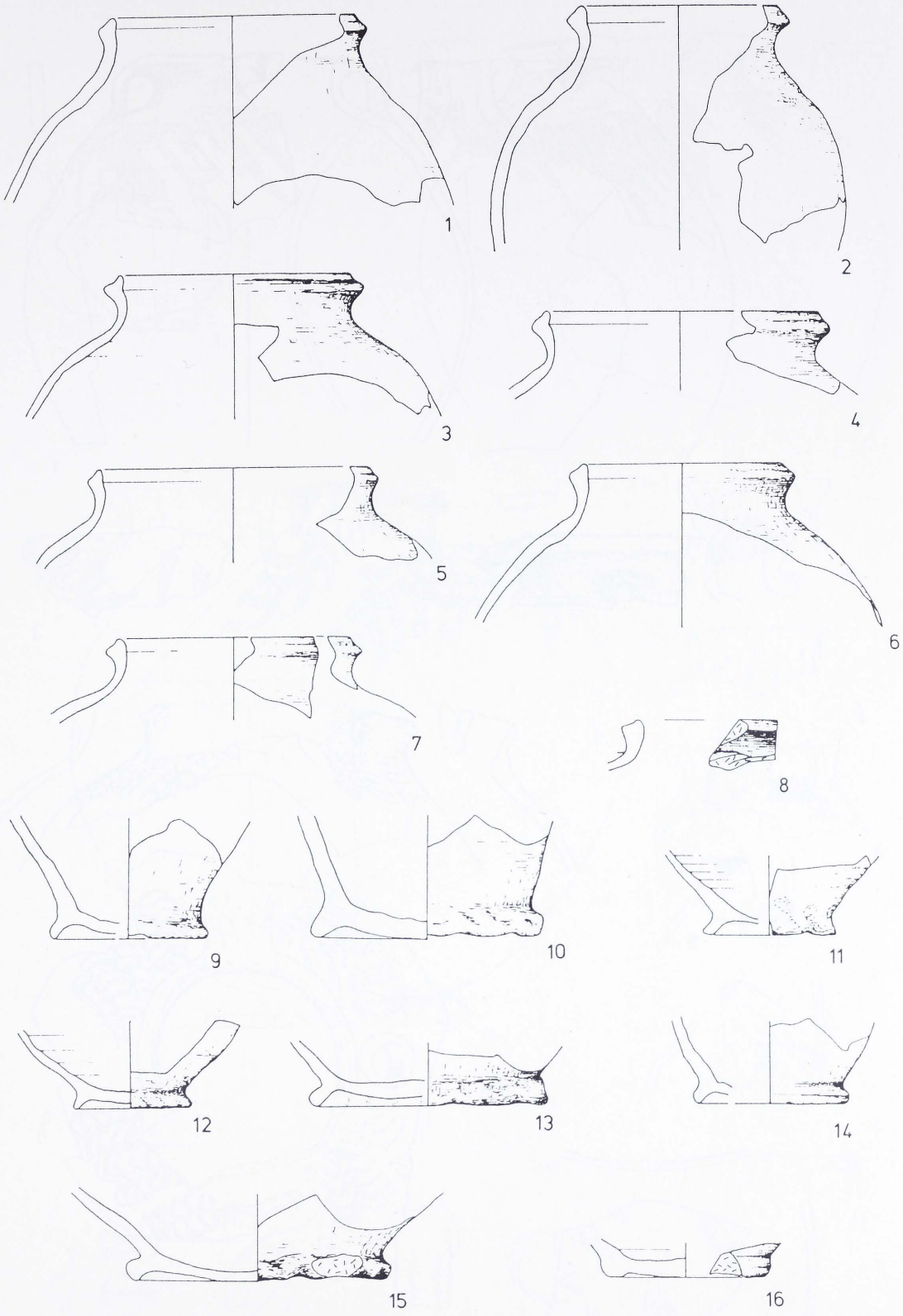

Tafel: 81
 Maßstab: 1:3
 Komplex: 48

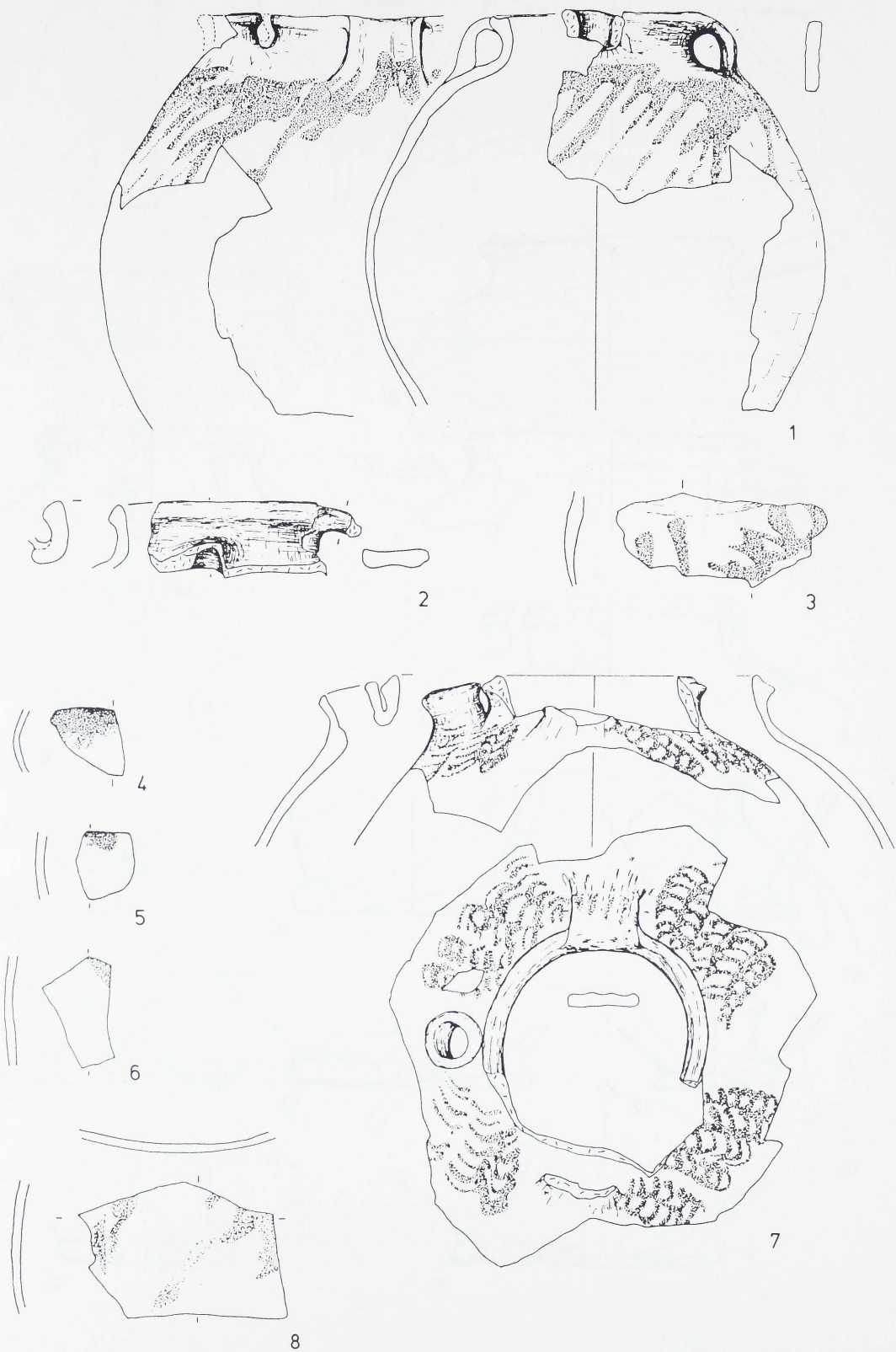

Tafel: 82
 Maßstab: 1:3
 Komplex: 51

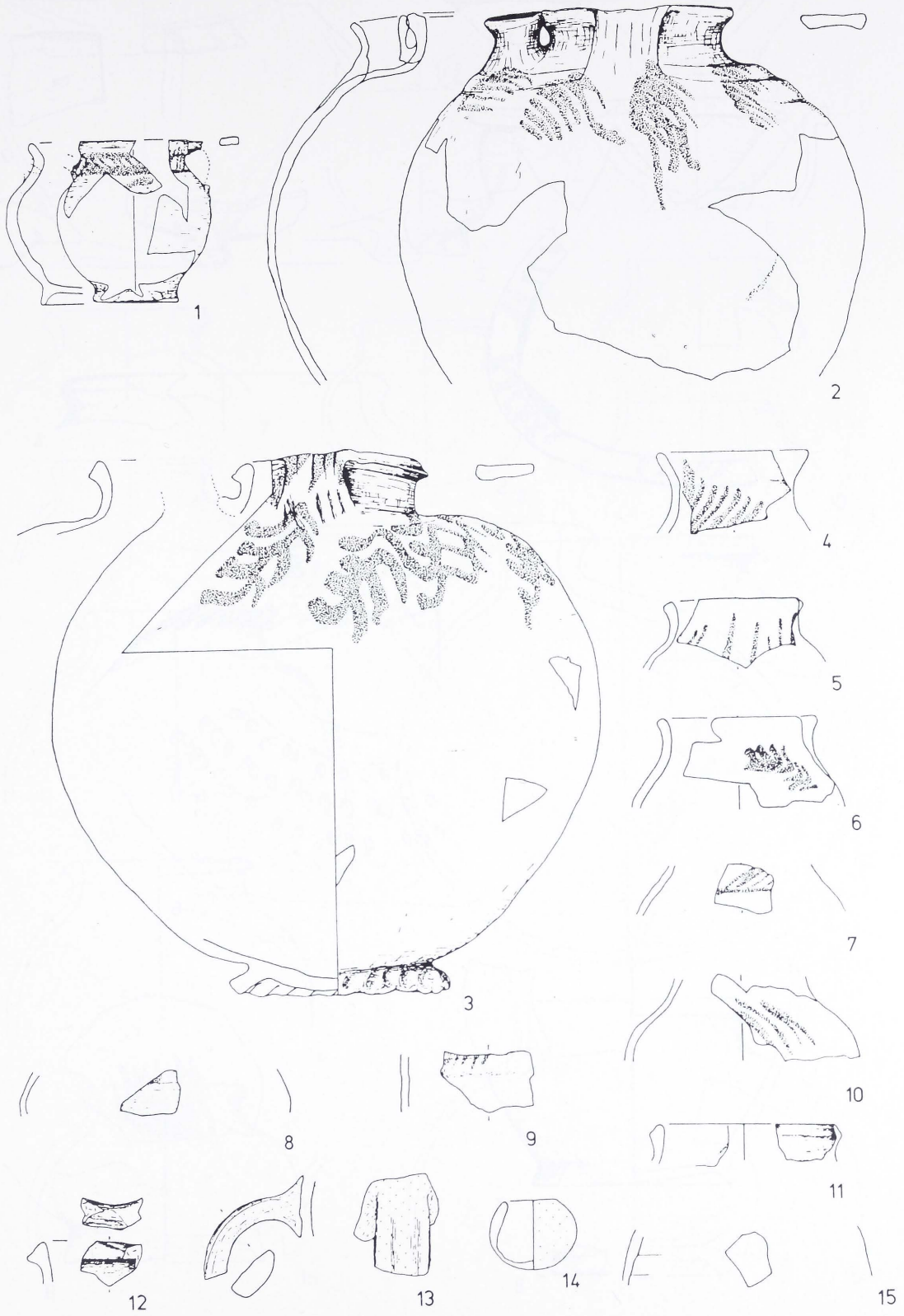

Tafel: 83
 Maßstab: 1:3
 Komplex: 51

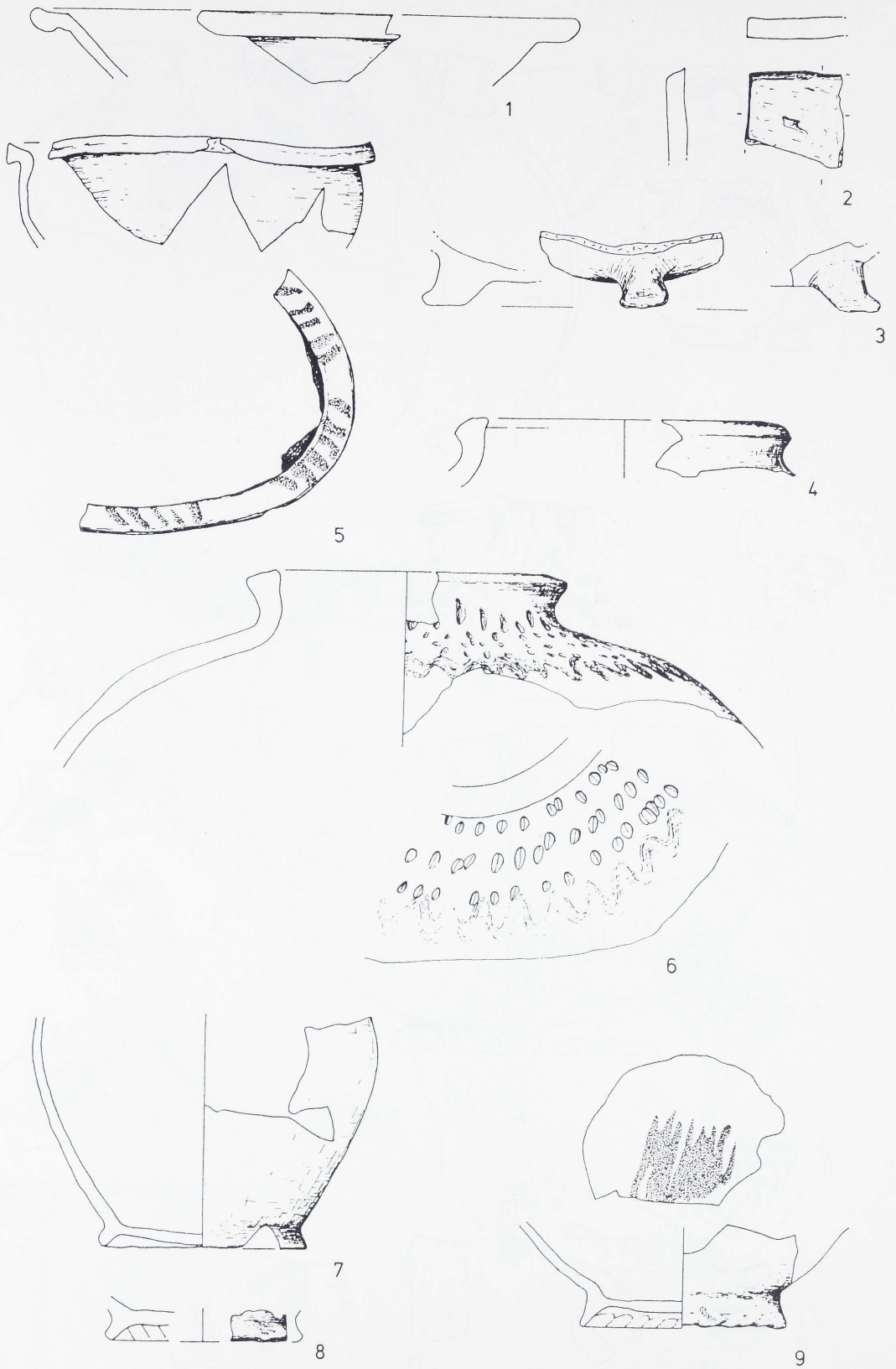

Tafel: 84
 Maßstab: 1:3
 Komplex: 51

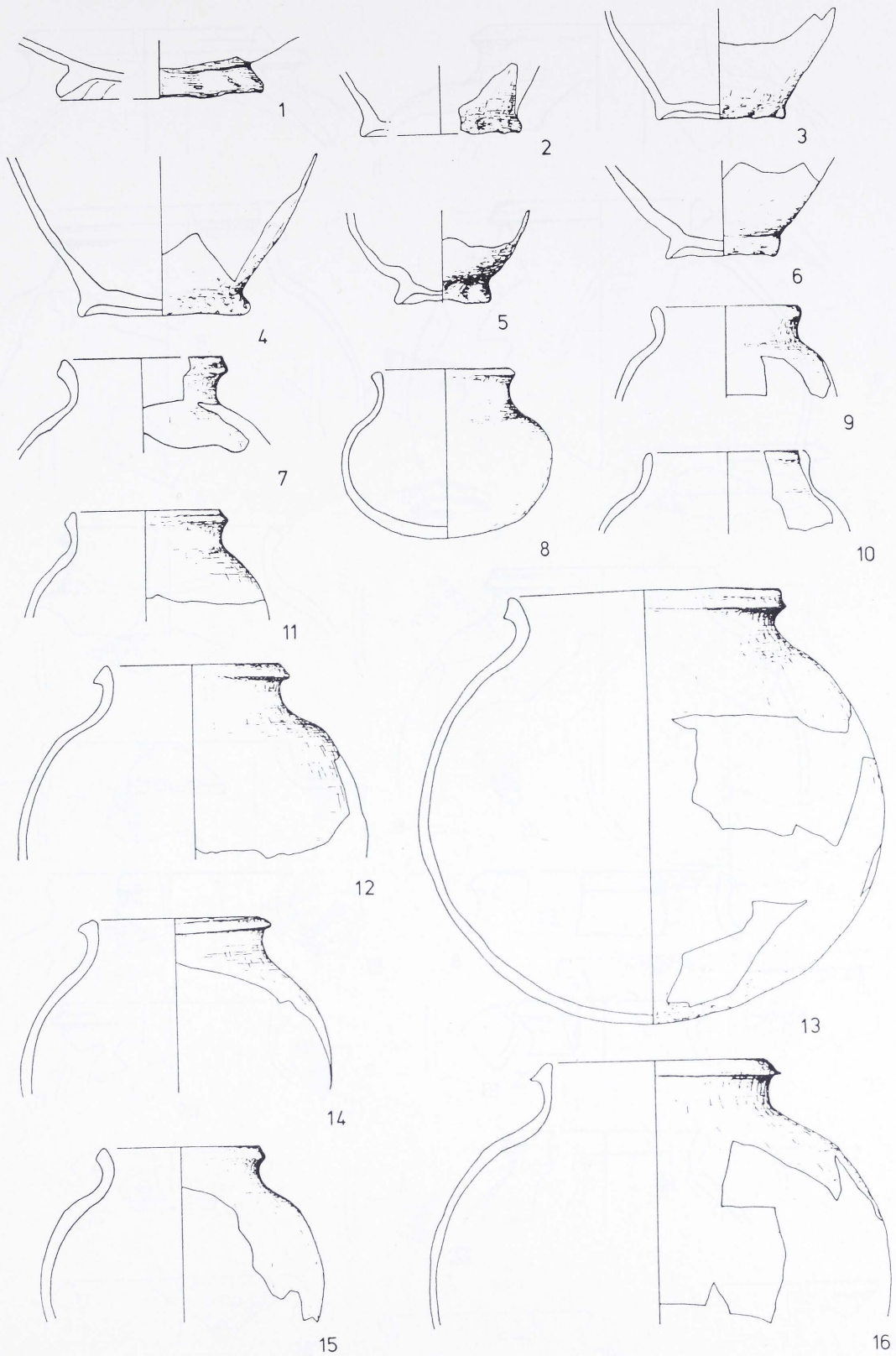

Tafel: 85
 Maßstab: 1:3
 Komplex: 51

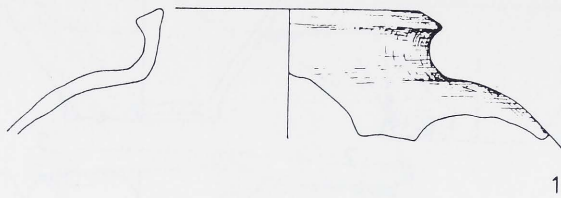

1

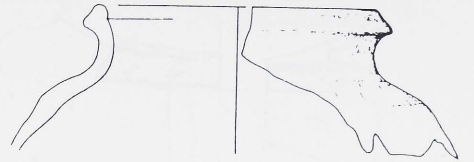

2

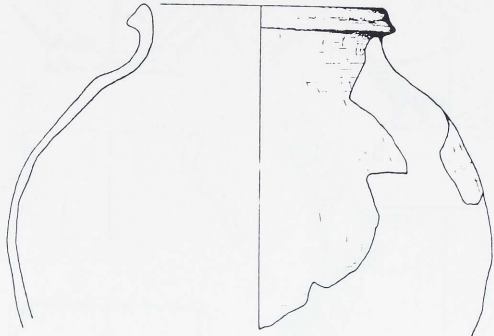

3

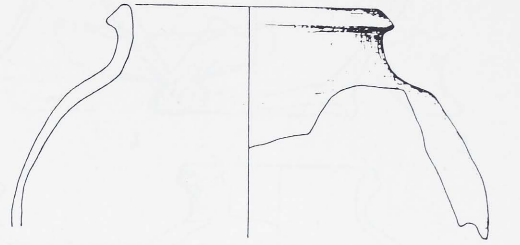

4

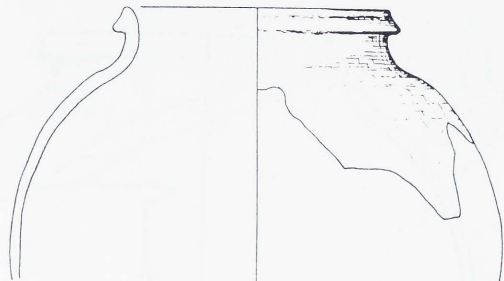

6

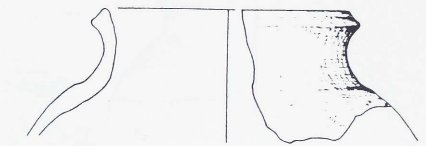

5



7

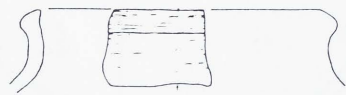

8



9



10

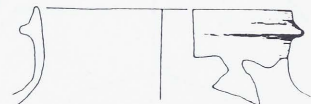

11

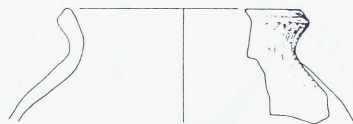

12

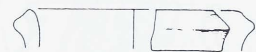

13

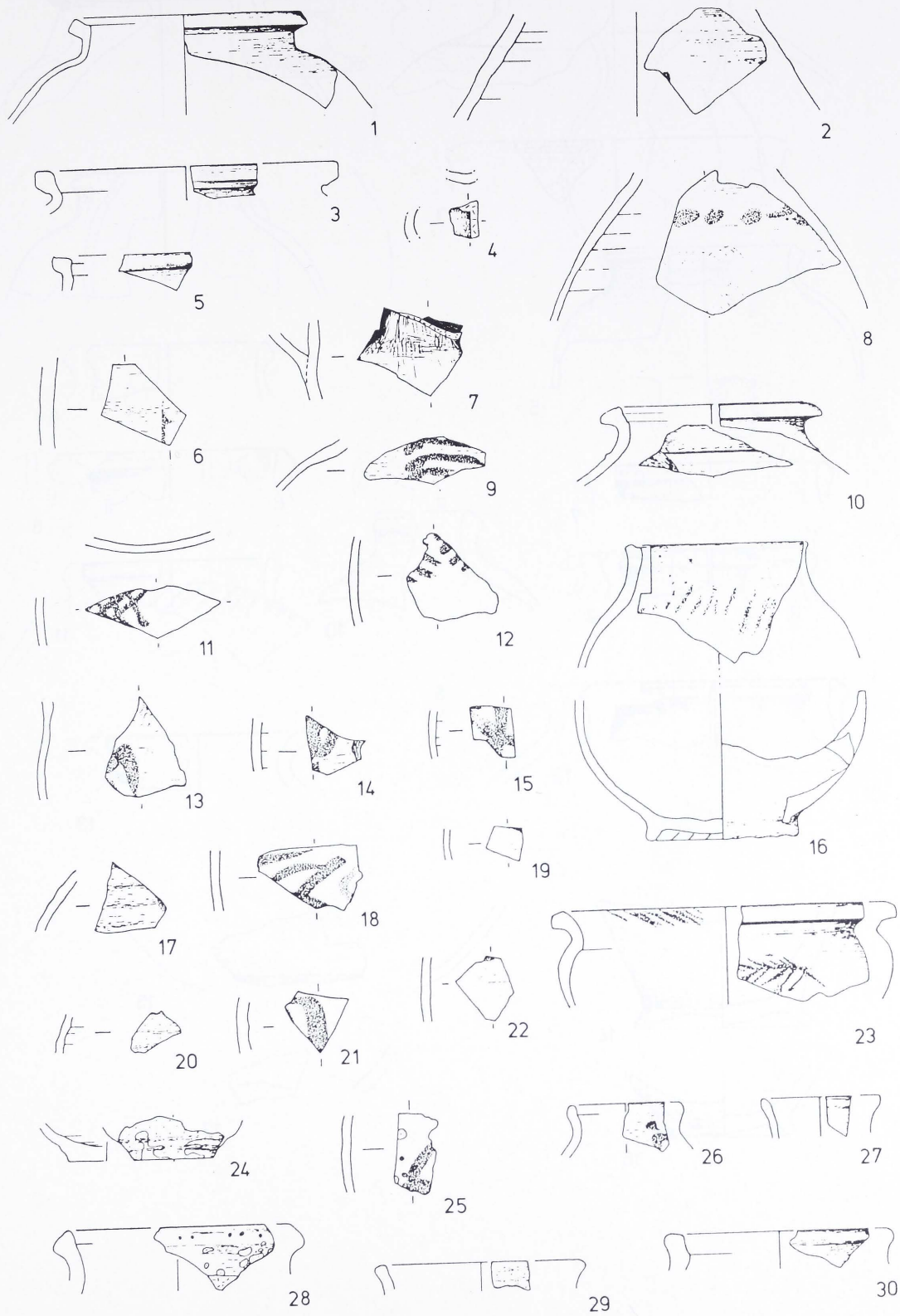

Tafel: 87
 Maßstab: 1:3
 Komplex: 52

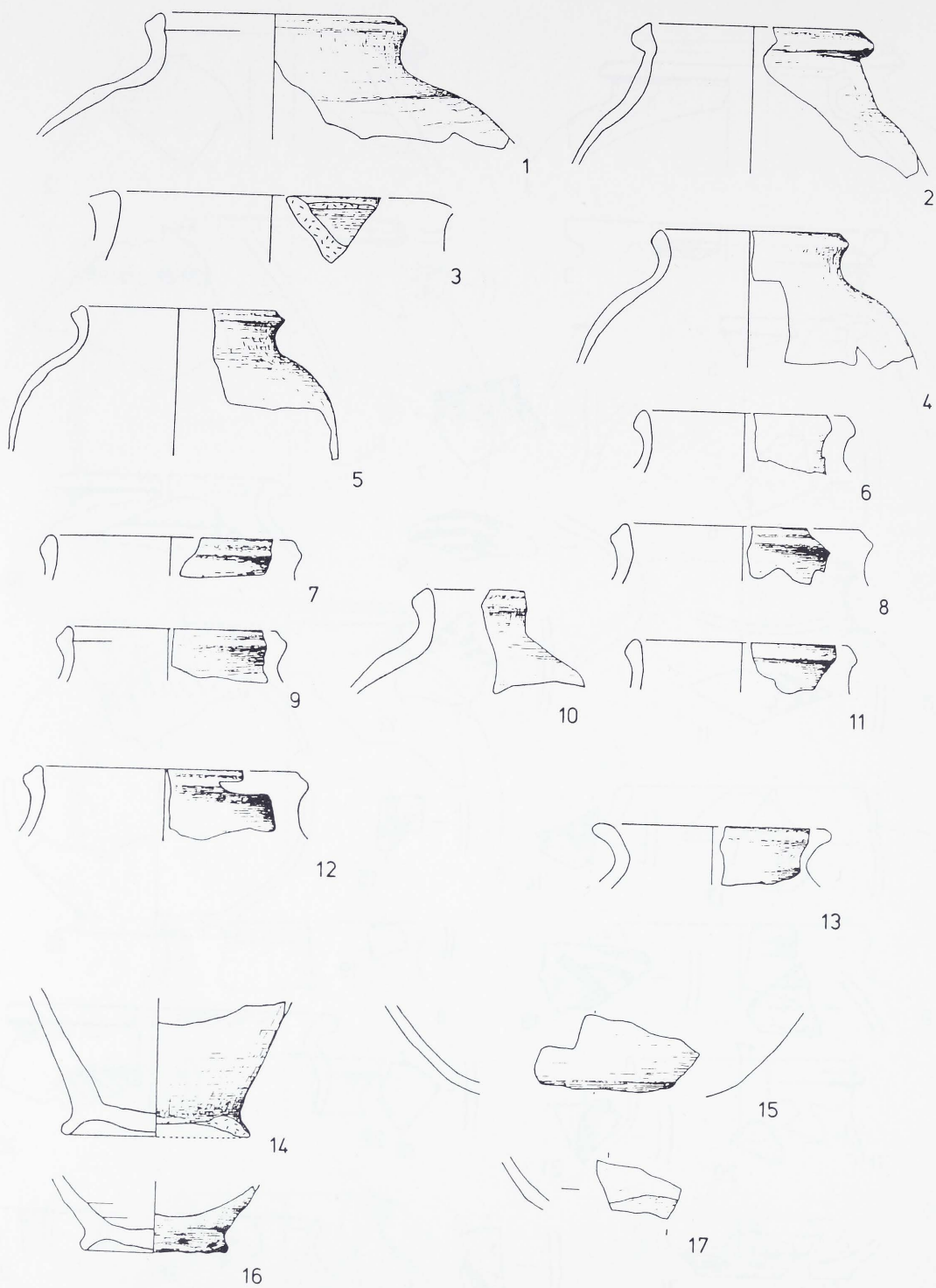

Tafel: 88
 Maßstab: 1:3
 Komplex: 52

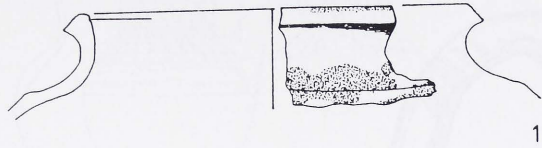

1

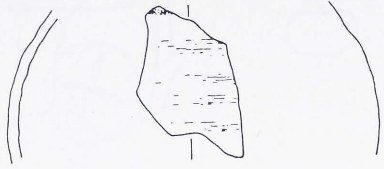

2

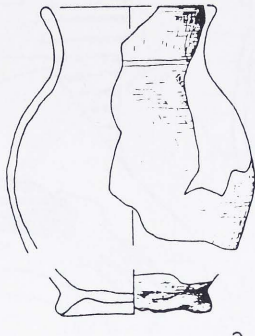

3



4



5



6

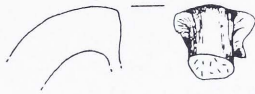

7



8



9

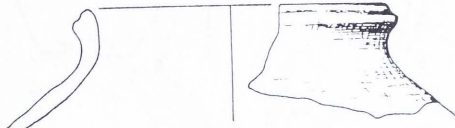

10

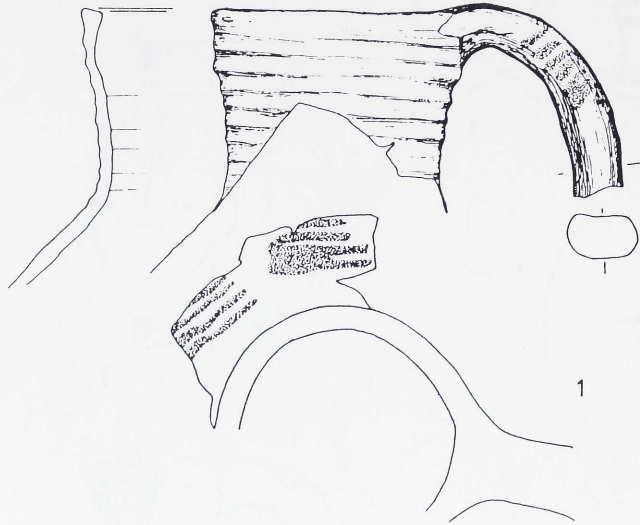

1

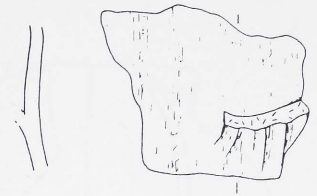

2

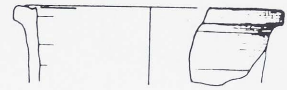

3

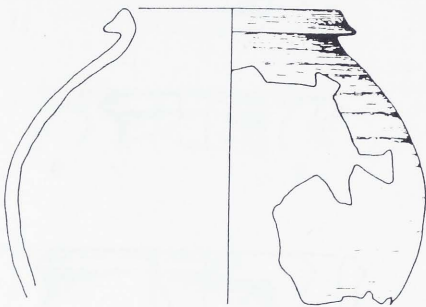

4



5



6



7

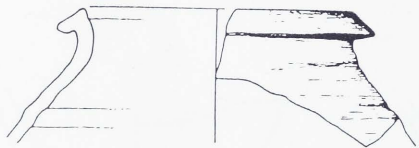

8



9



10

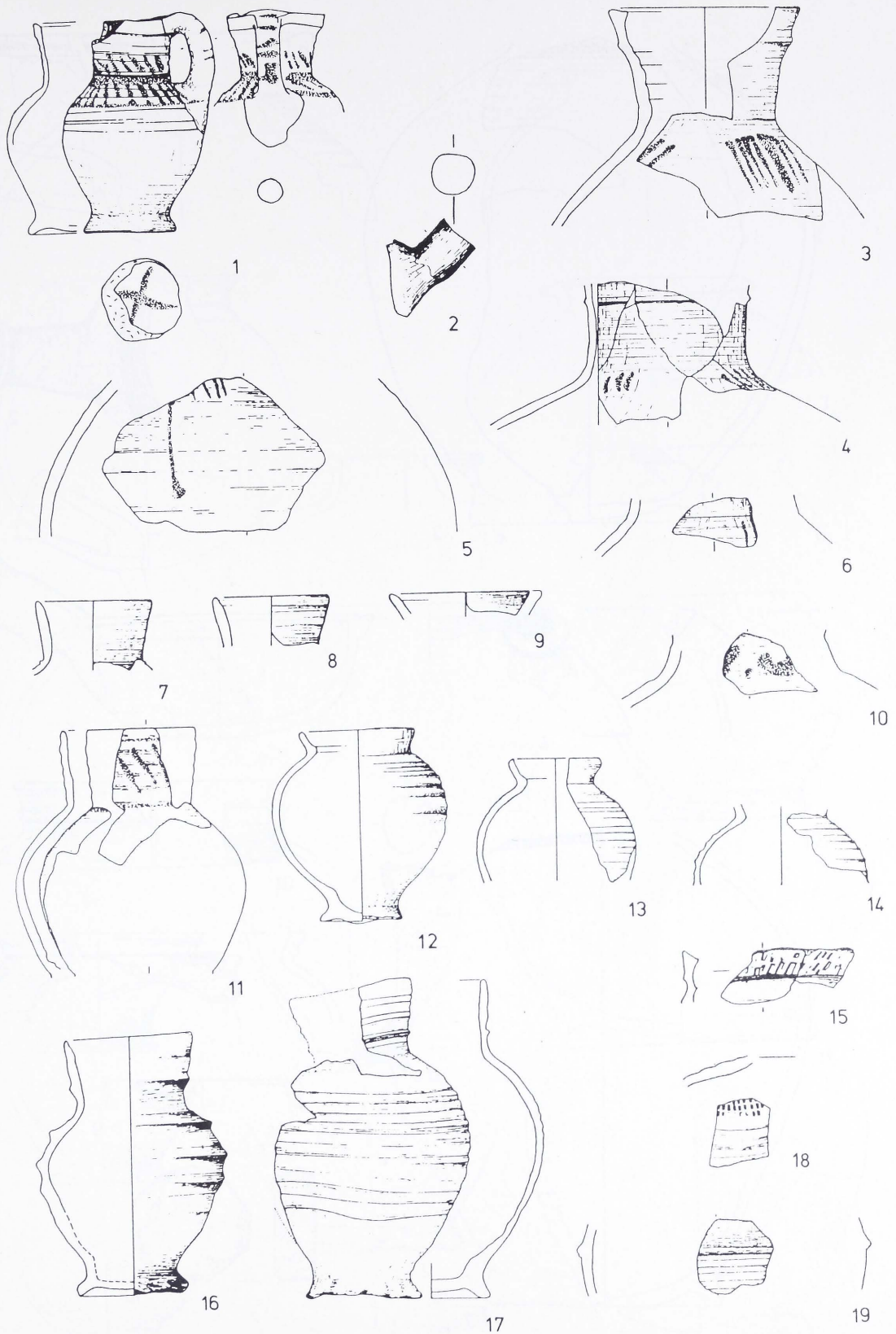

Tafel: 91
 Maßstab: 1:3
 Komplex: 55

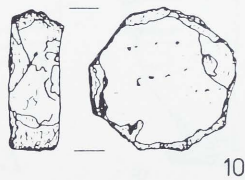
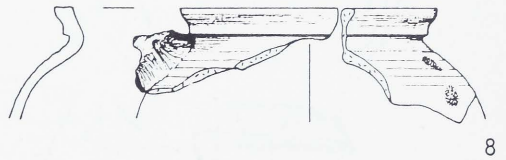
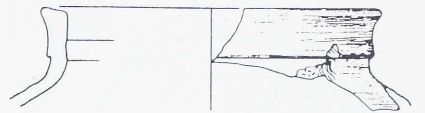
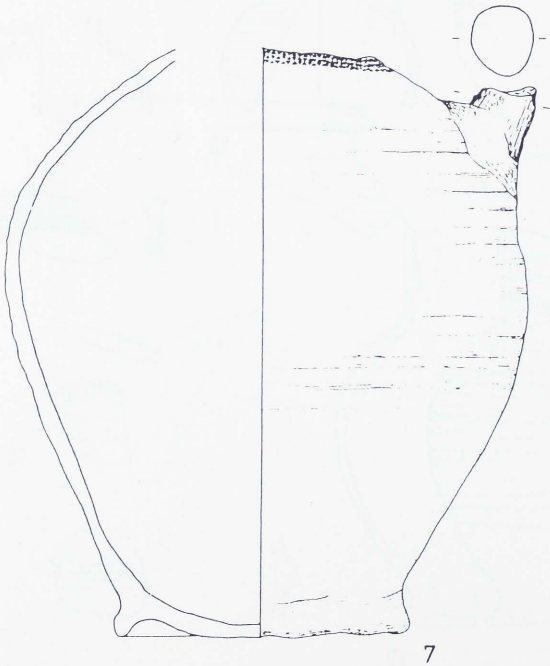
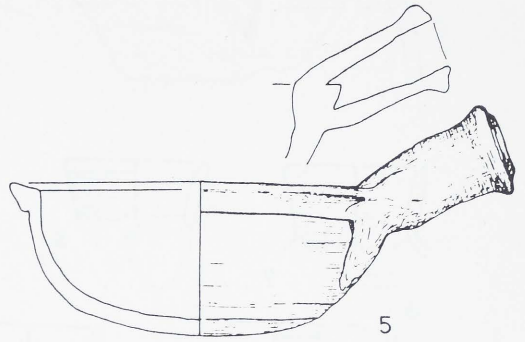
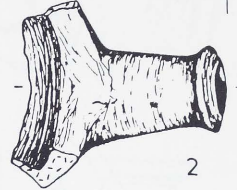
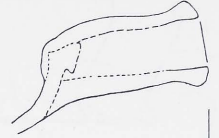
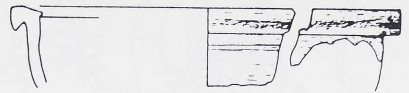
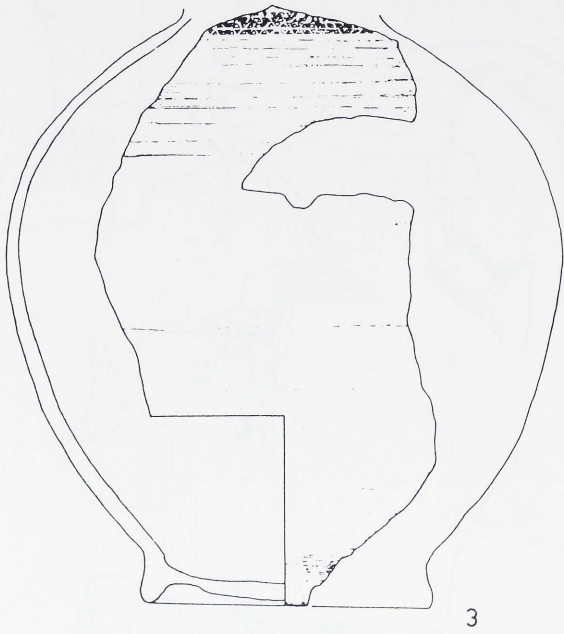

Tafel: 92
Maßstab: 1:3
Komplex: 55

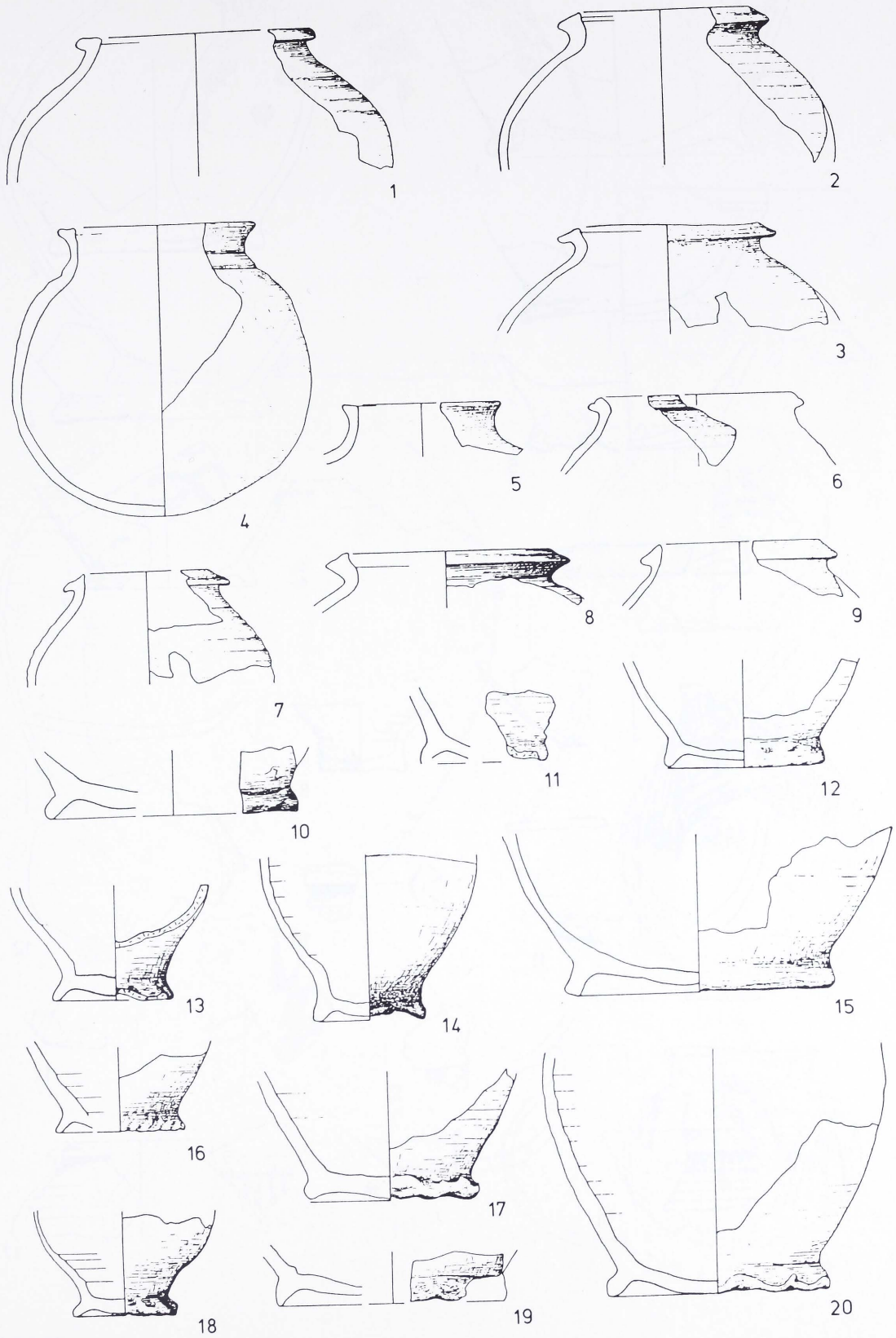

Tafel: 93
 Maßstab: 1:3
 Komplex: 55

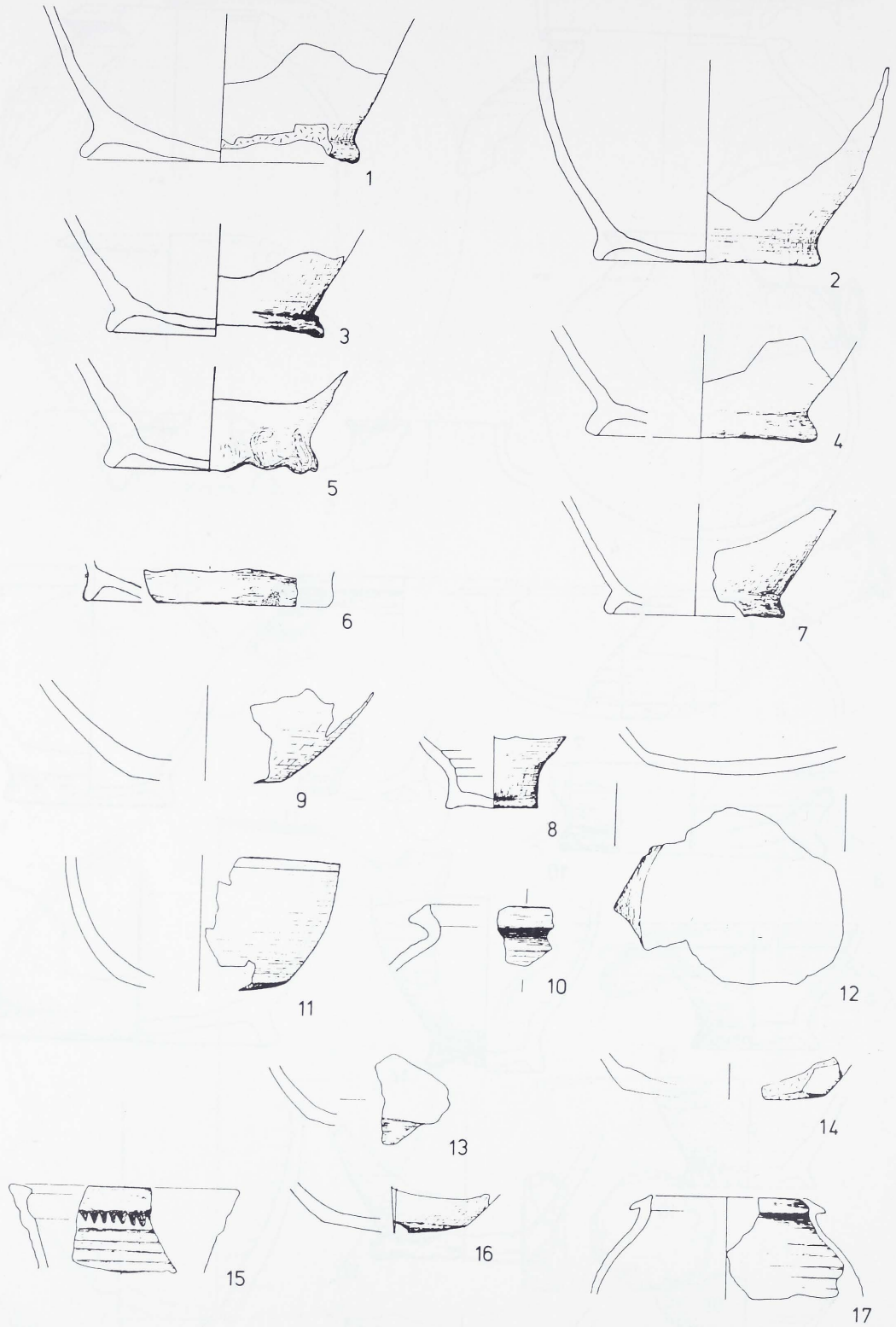

Tafel: 94
 Maßstab: 1:3
 Komplex: 55

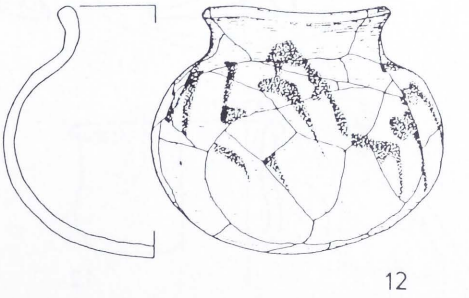
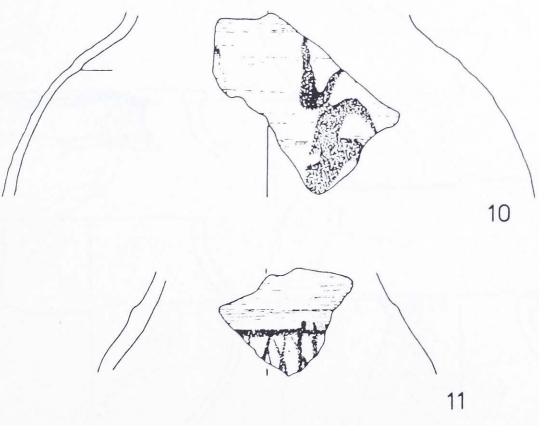
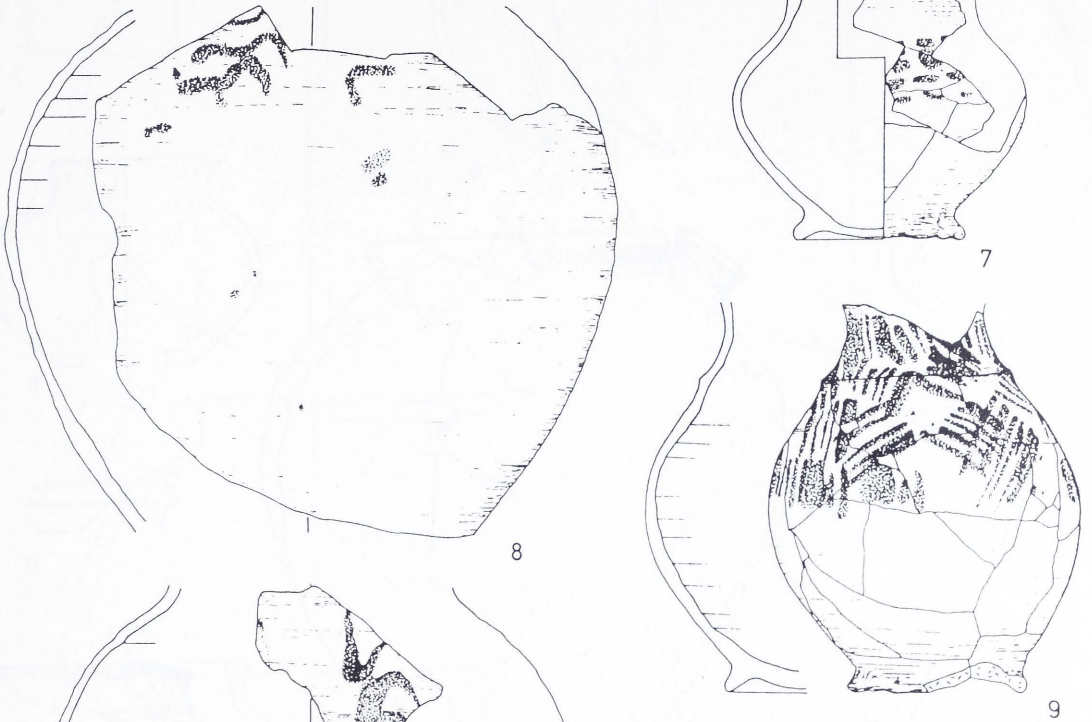

Tafel: 95
 Maßstab: 1:3
 Komplex: 57

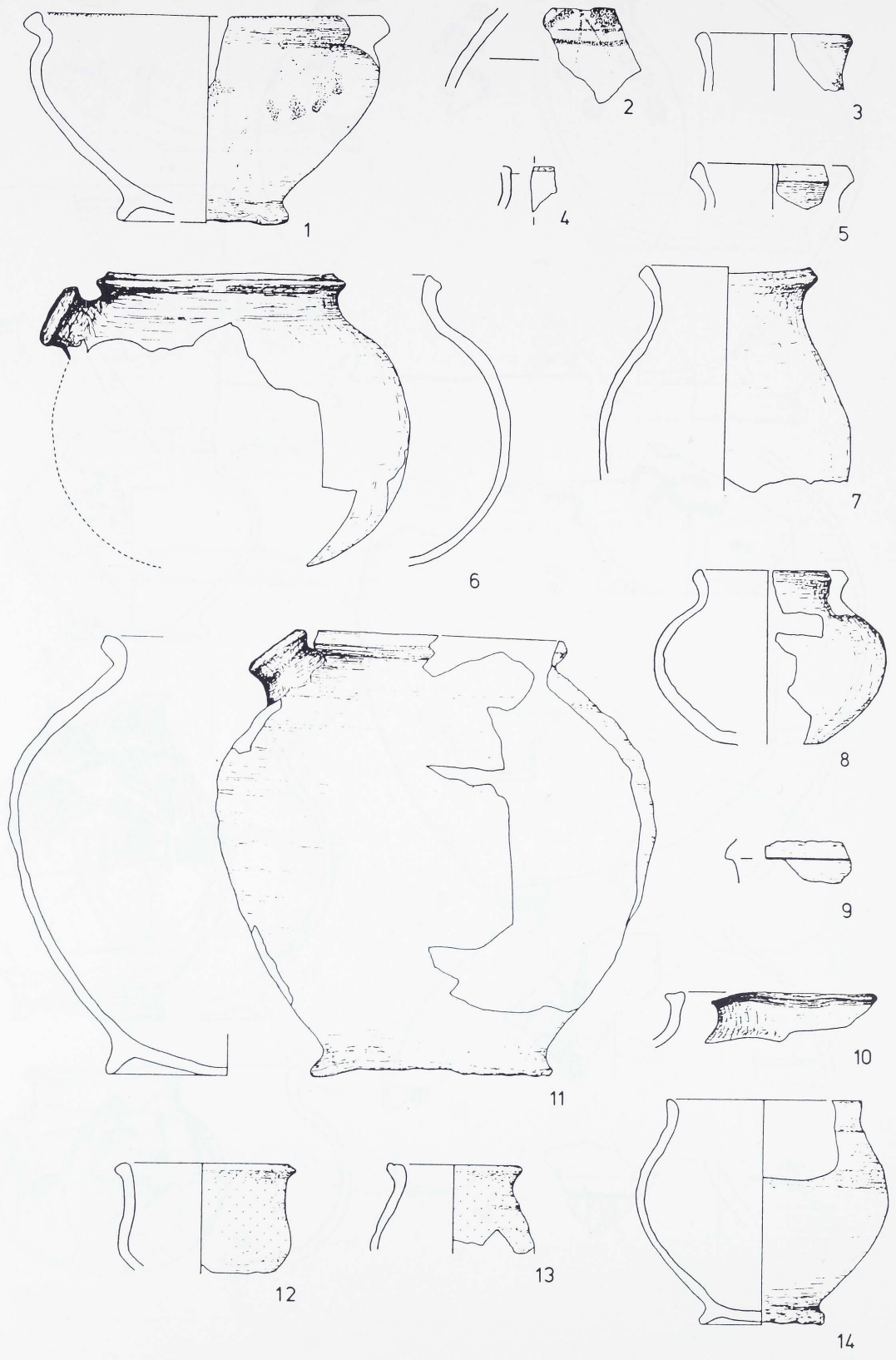

Tafel: 96
 Maßstab: 1:3
 Komplex: 57

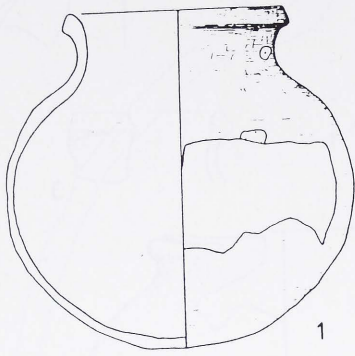

1

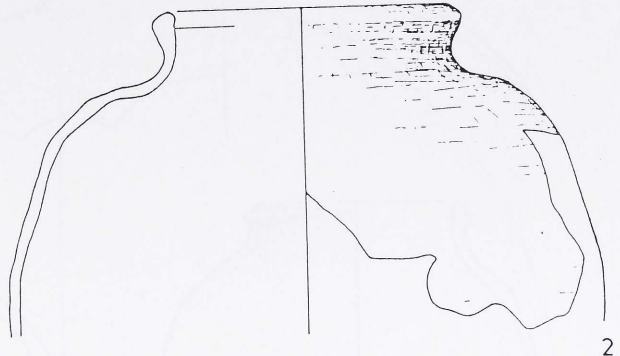

2

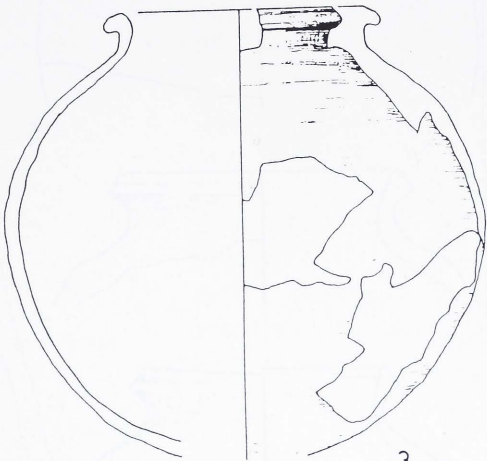

3

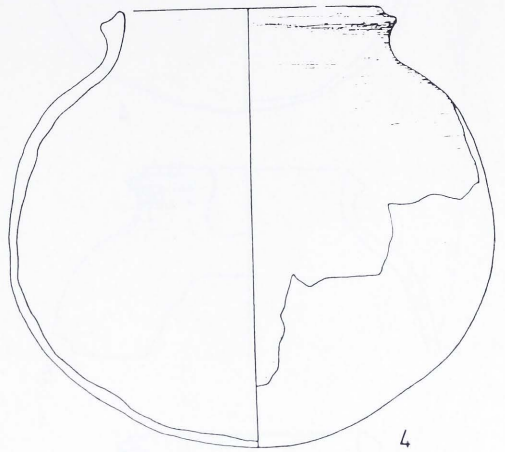

4

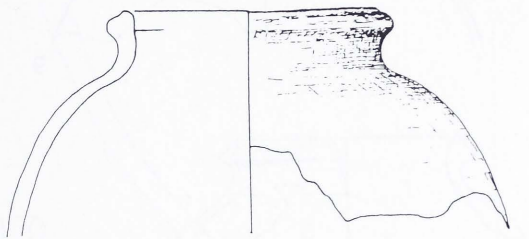

5

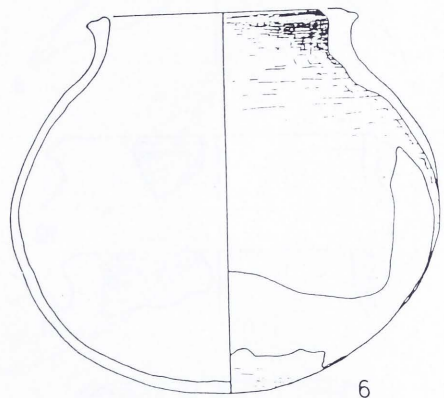

6

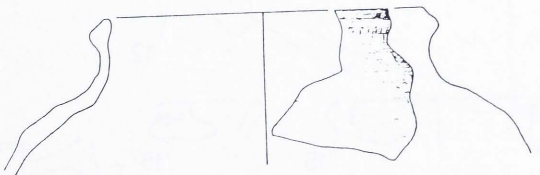

7

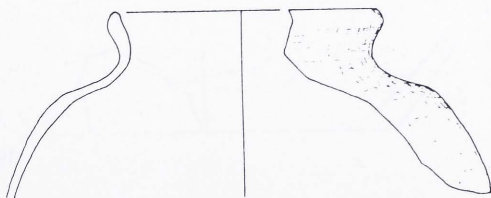

8

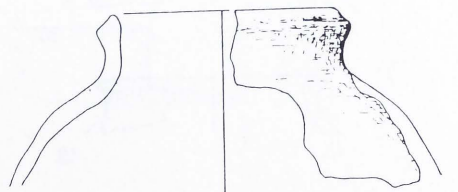

9

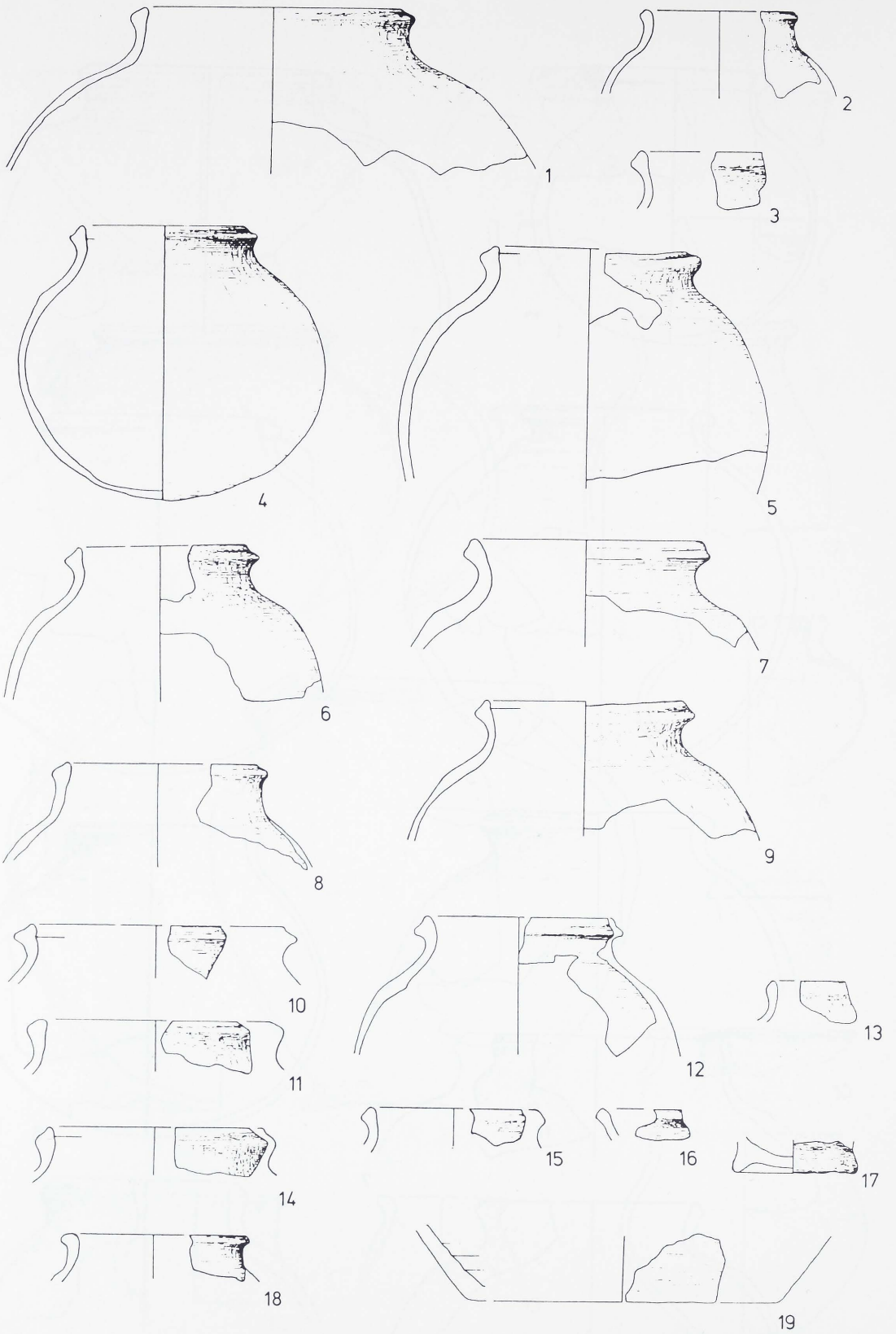

Tafel: 98
 Maßstab: 1:3
 Komplex: 57

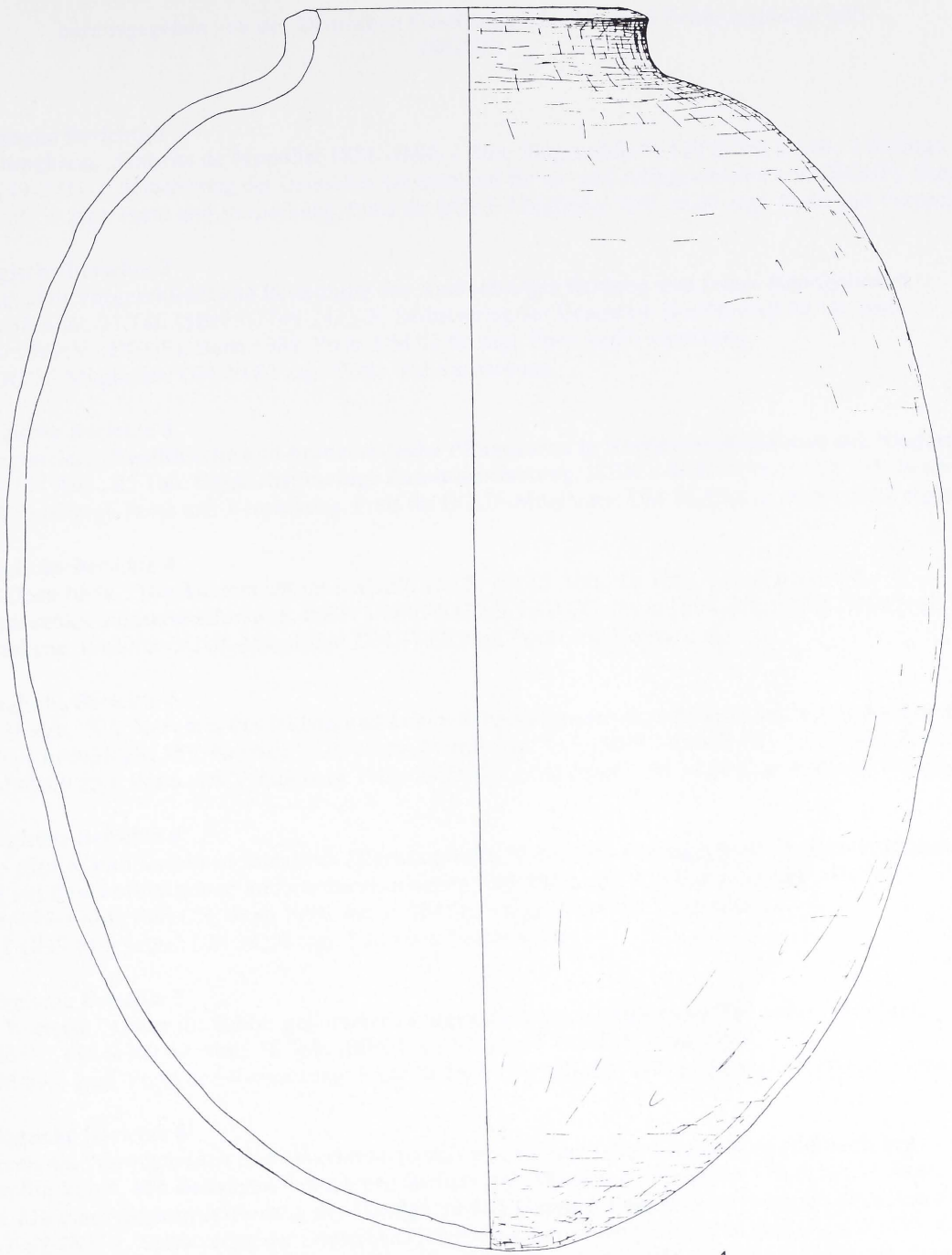

1



2

Tafel: 99
Maßstab: 1:3
Komplex: 57