

Enger-Ost, Befunde 1 und 2; M 1:3.

TAFEL 2

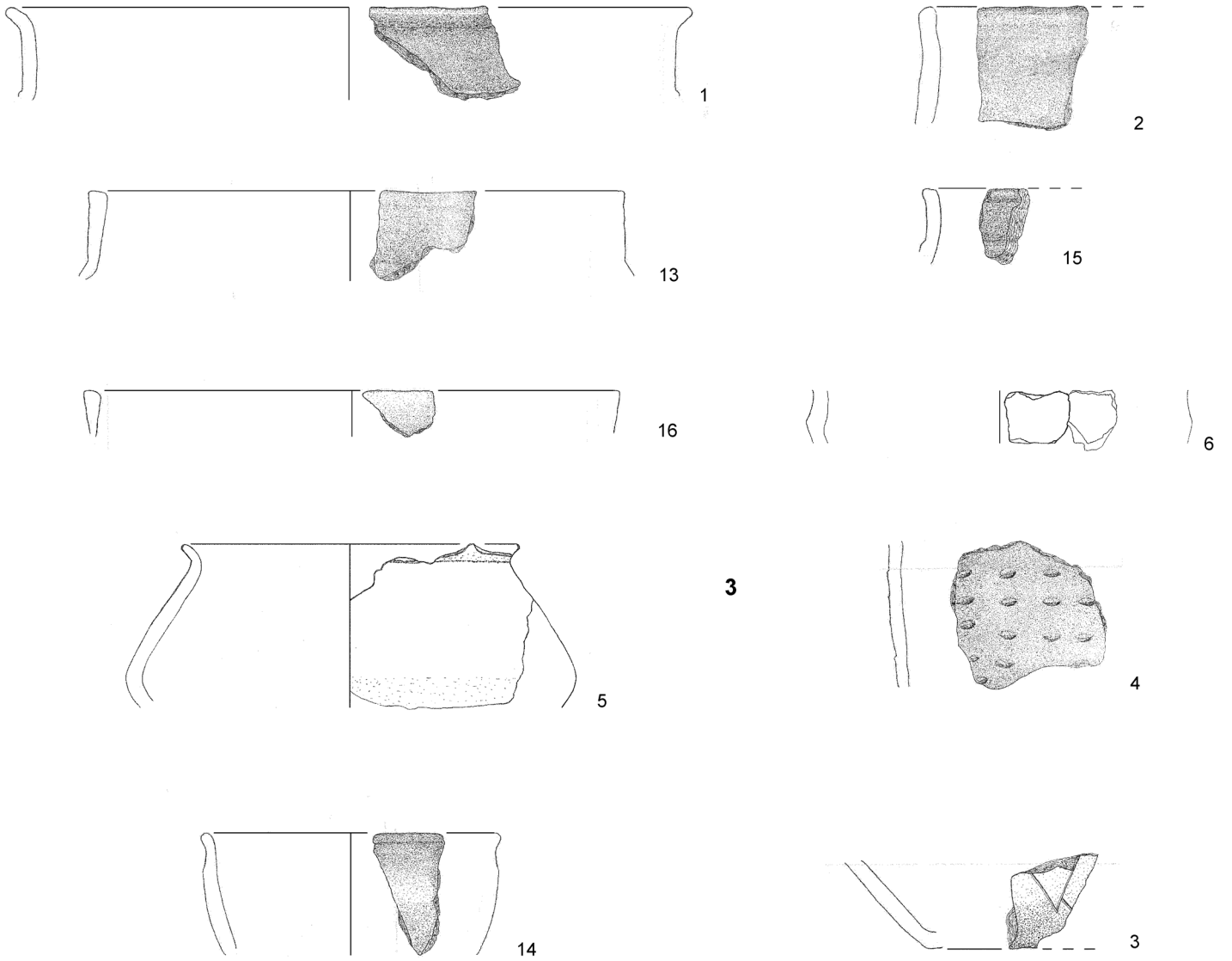

3a

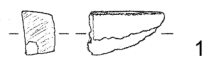

3b

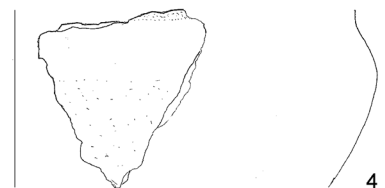
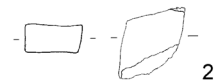

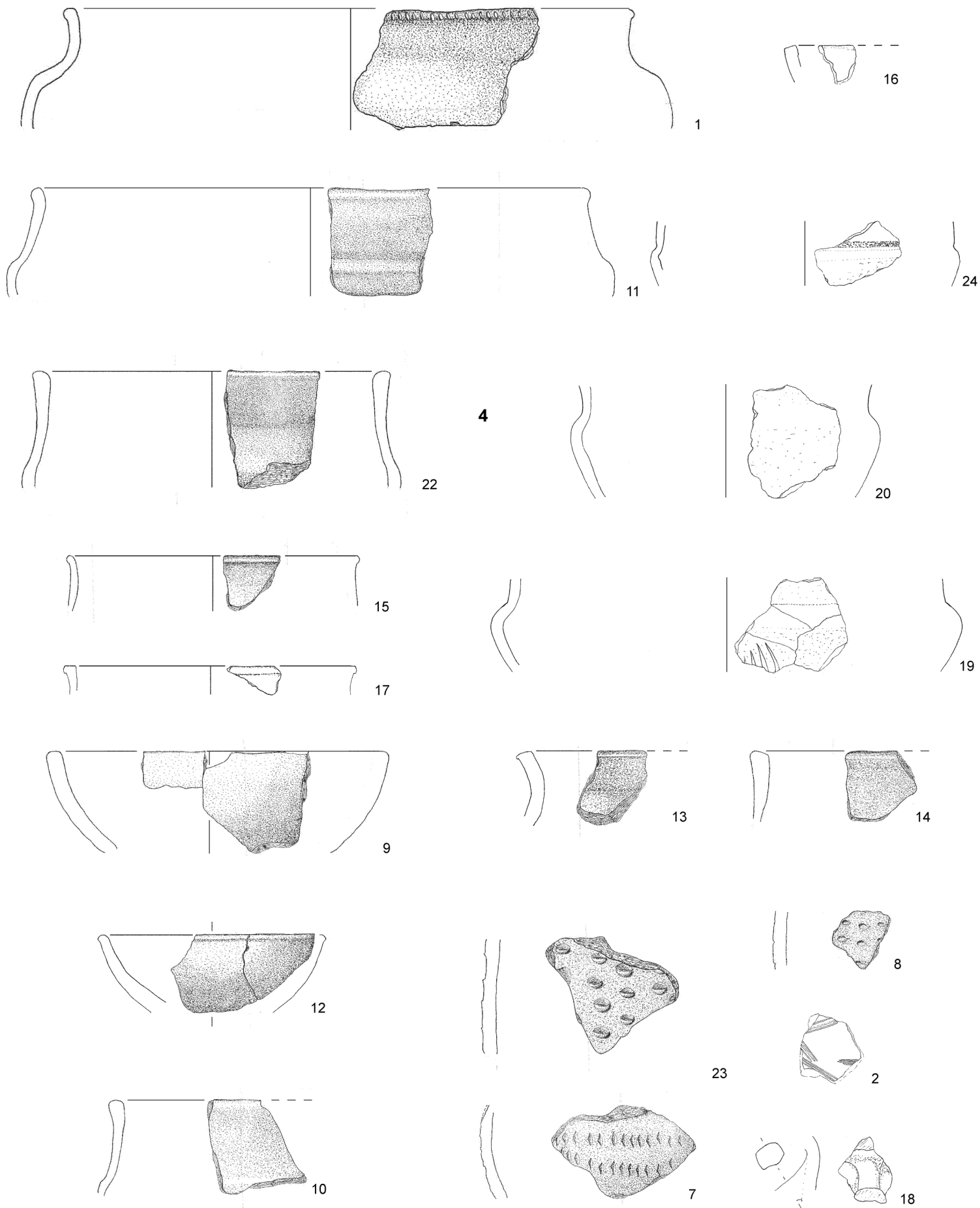

TAFEL 4

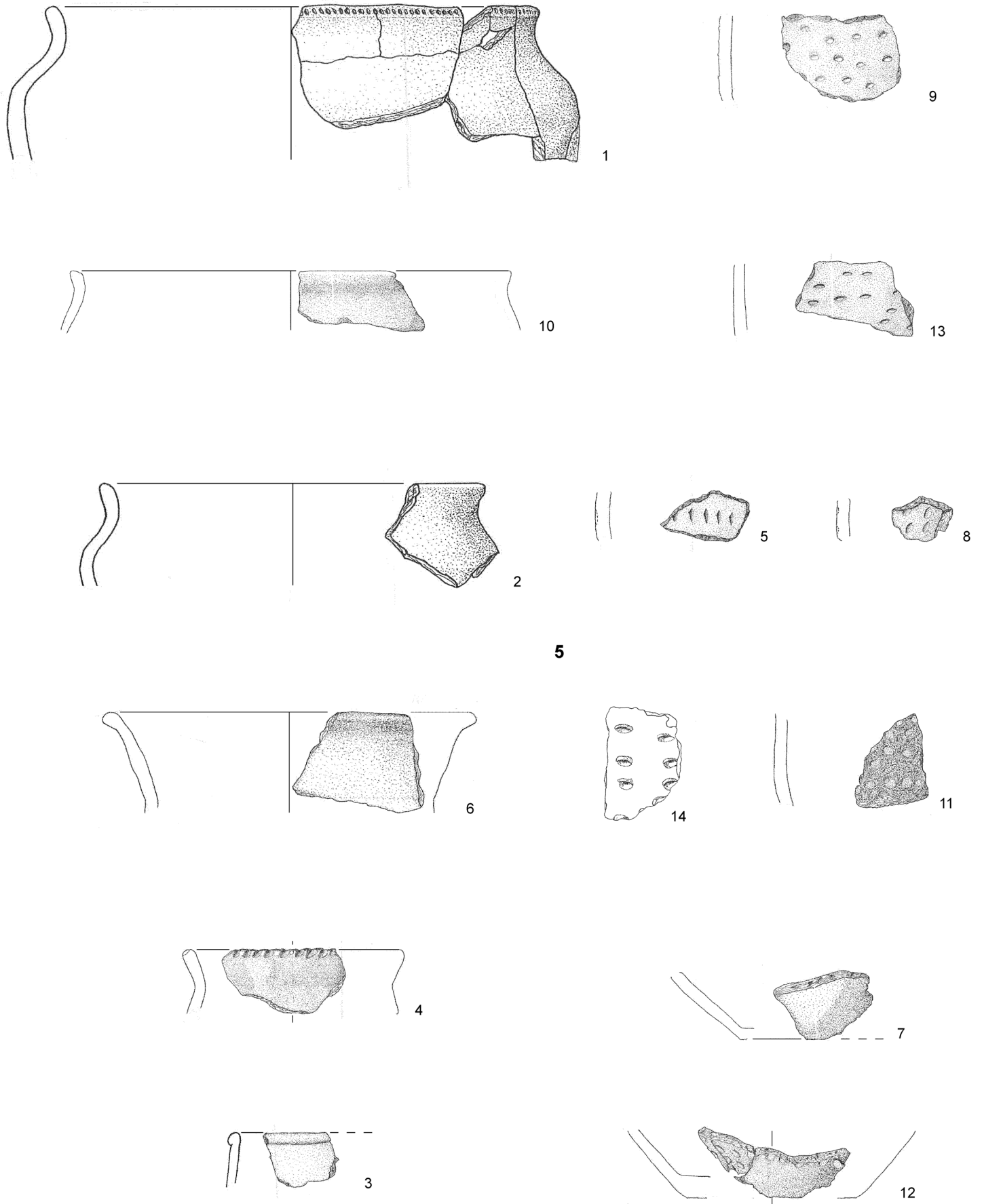

Enger-Ost, Befund 5 (oben links: Befund 5/F.-Nr. 1 und Befund 223?/F.-Nr. 1); M 1:3.

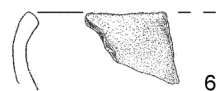
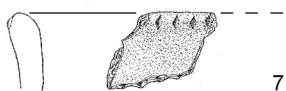
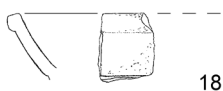
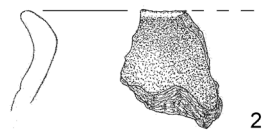
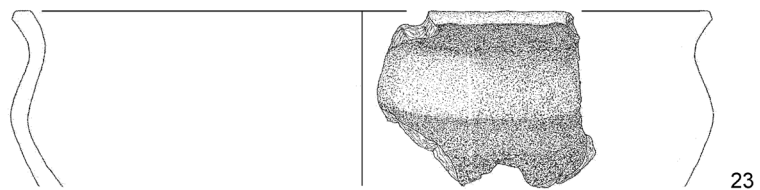
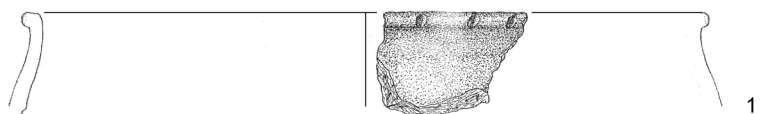
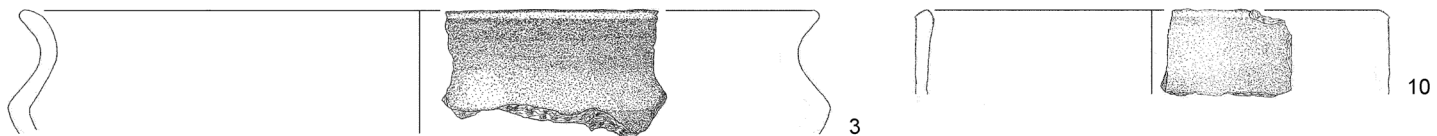

7

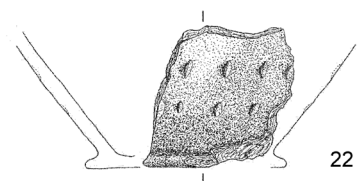
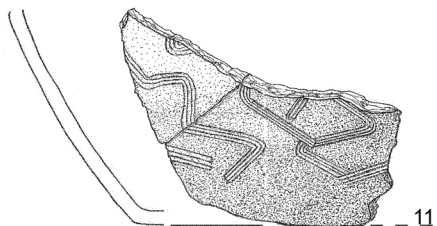
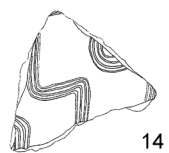
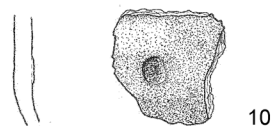
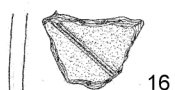
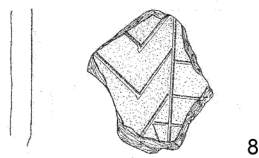

TAFEL 6

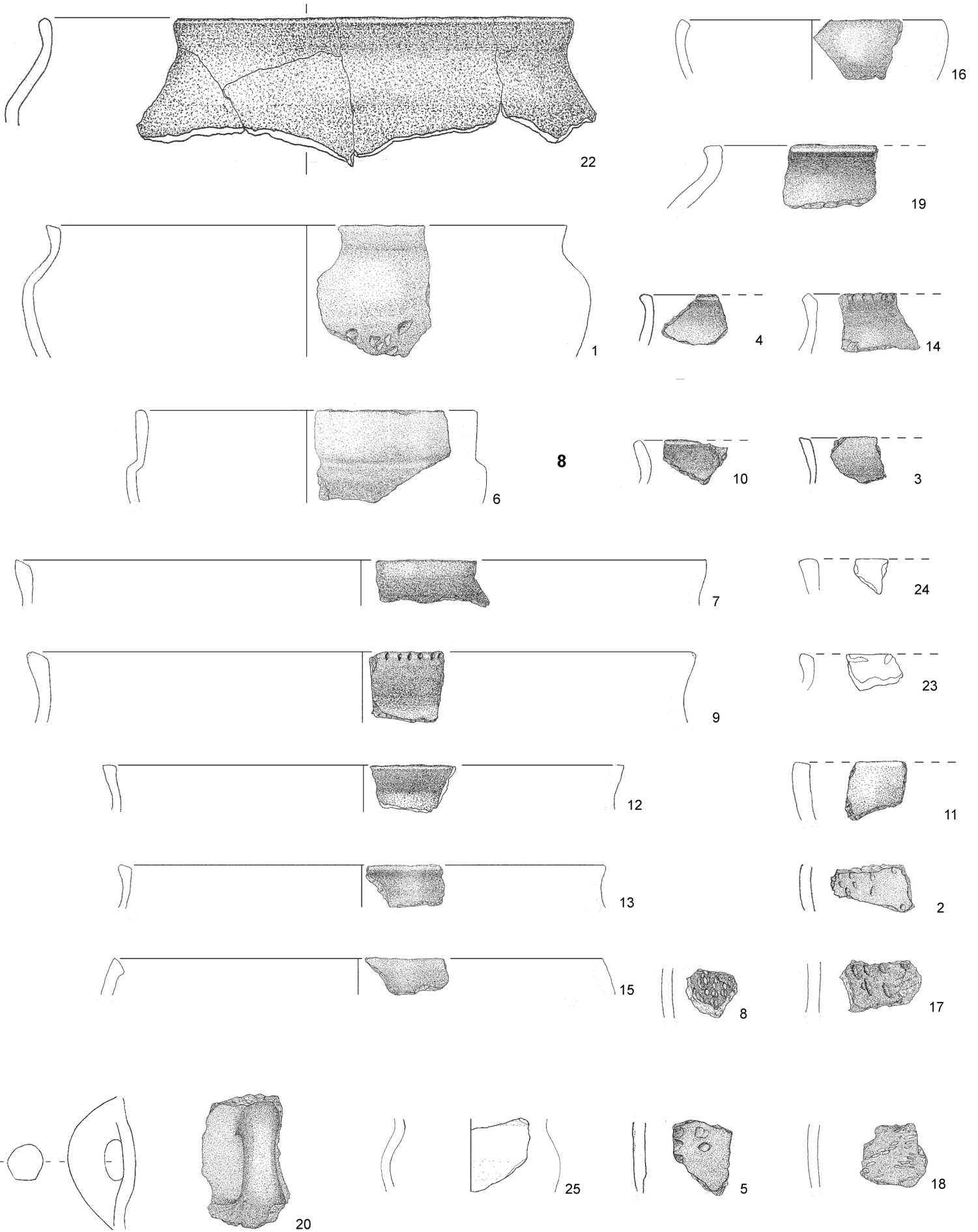

Enger-Ost, Befund 8 (F.-Nr. 1-25); M 1:3.

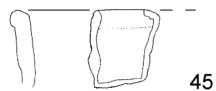
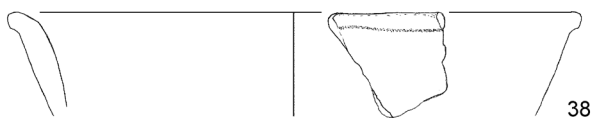
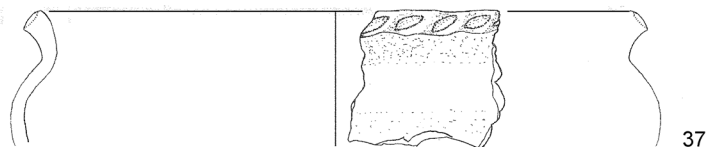
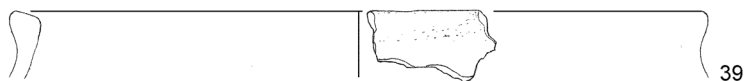

8

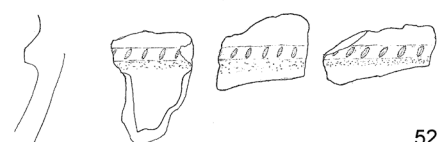
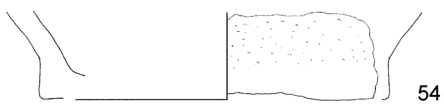
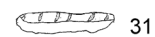

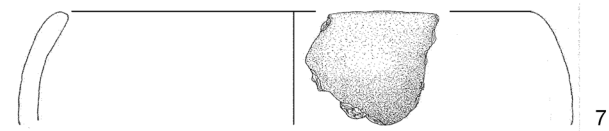
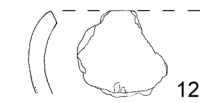
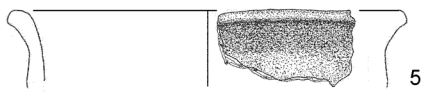
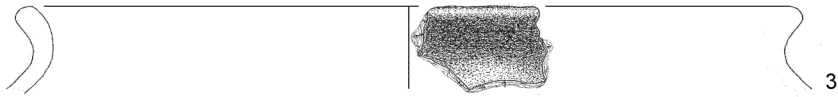
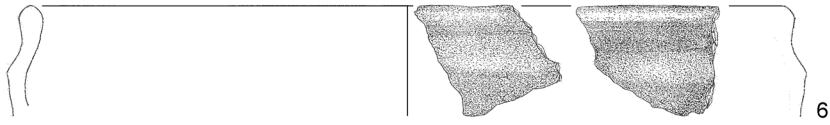
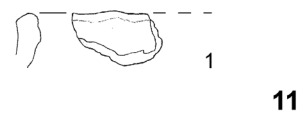
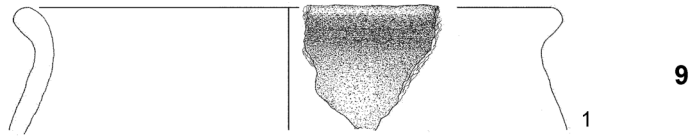

12

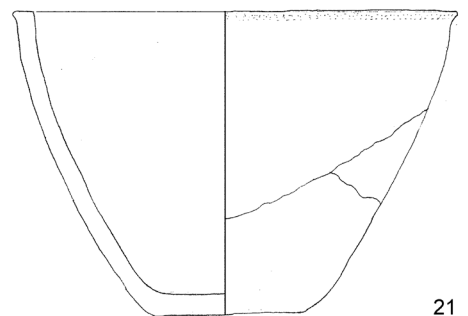
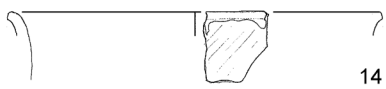
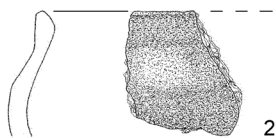
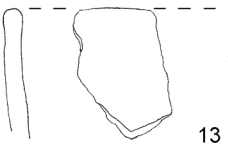

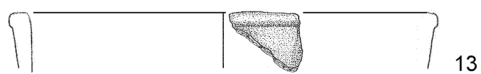
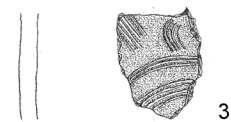
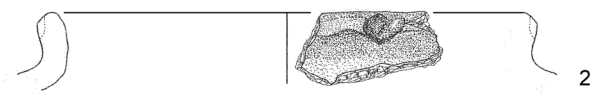

13

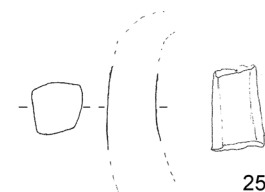
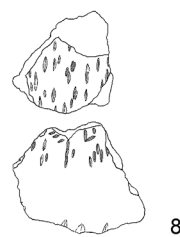
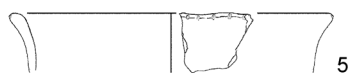
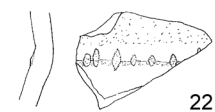
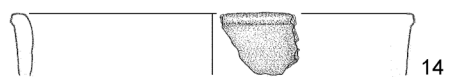

TAFEL 10

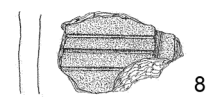
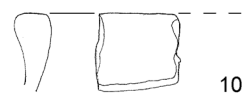
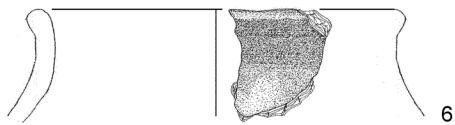
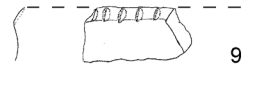

13a

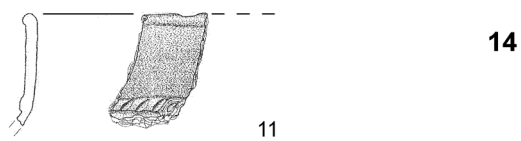
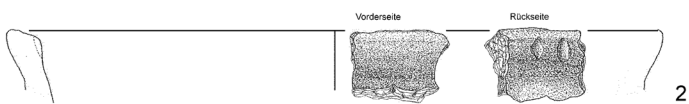
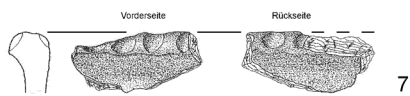
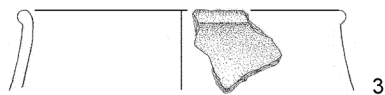

14



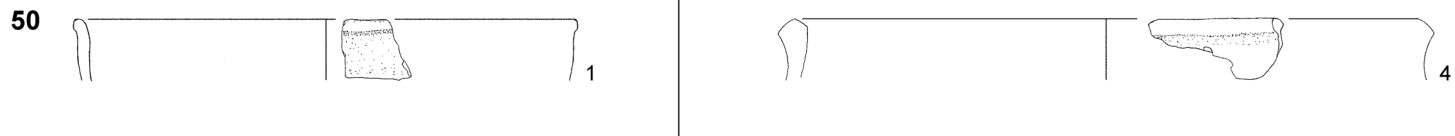
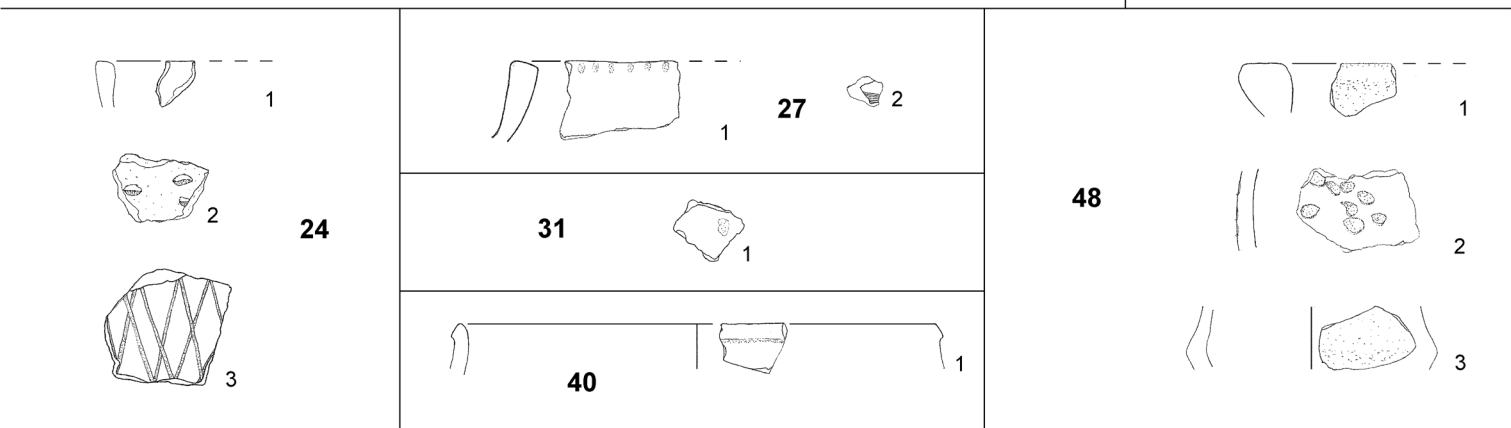
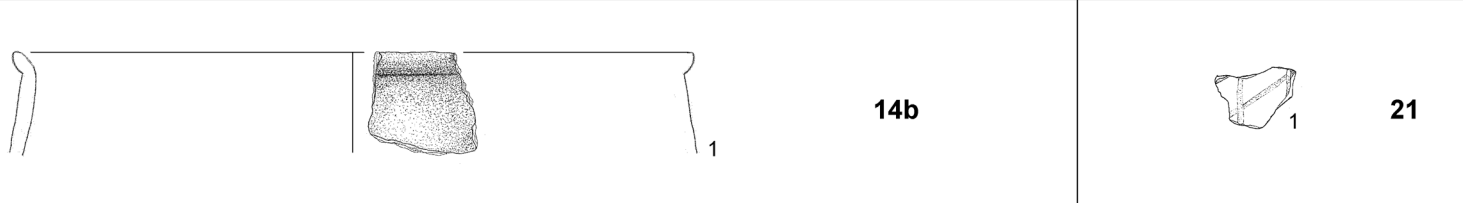
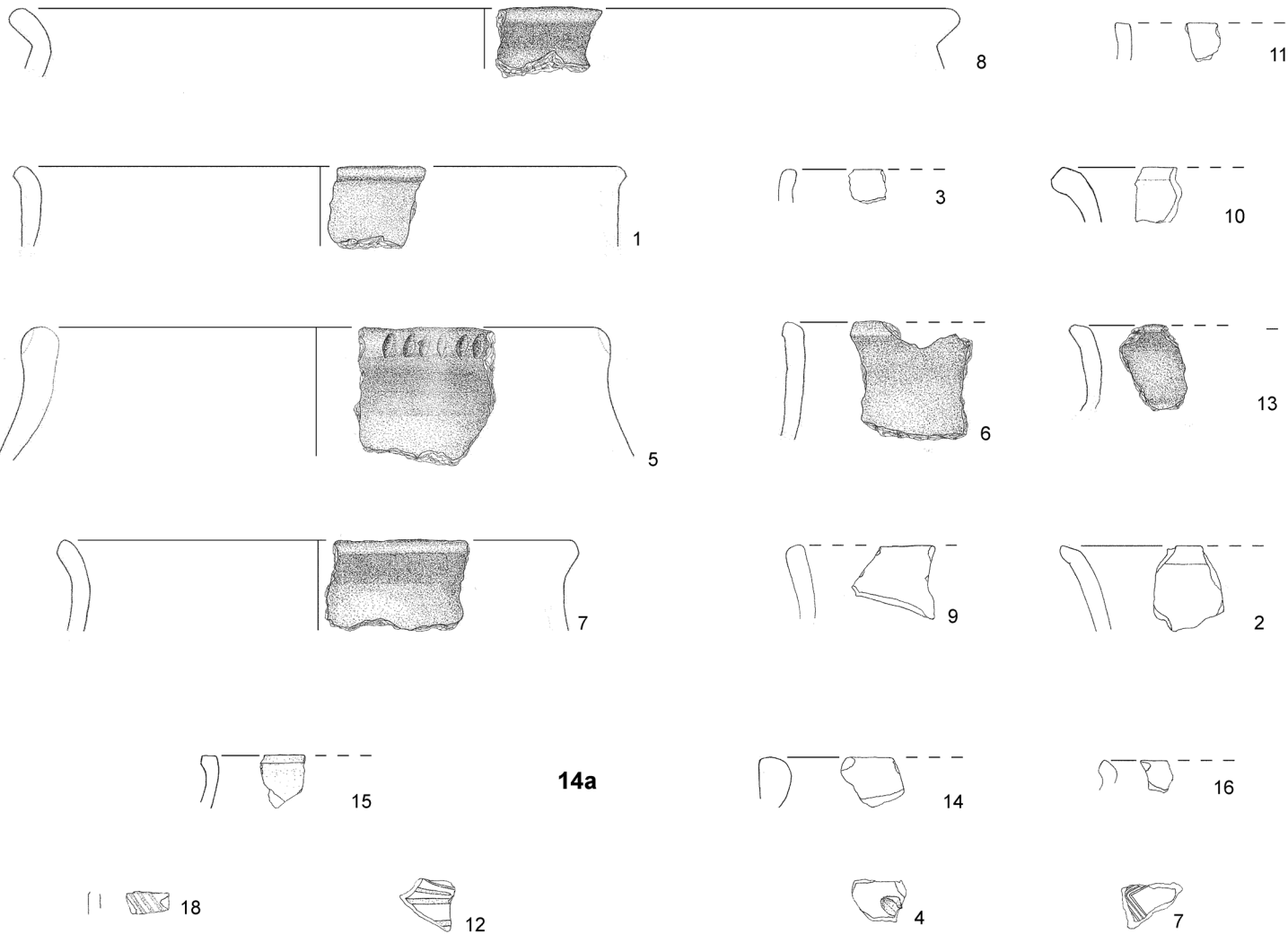

Enger-Ost, Befunde 14a, 14b, 21, 24, 27, 31, 40, 48 und 50; M 1:3.

TAFEL 12

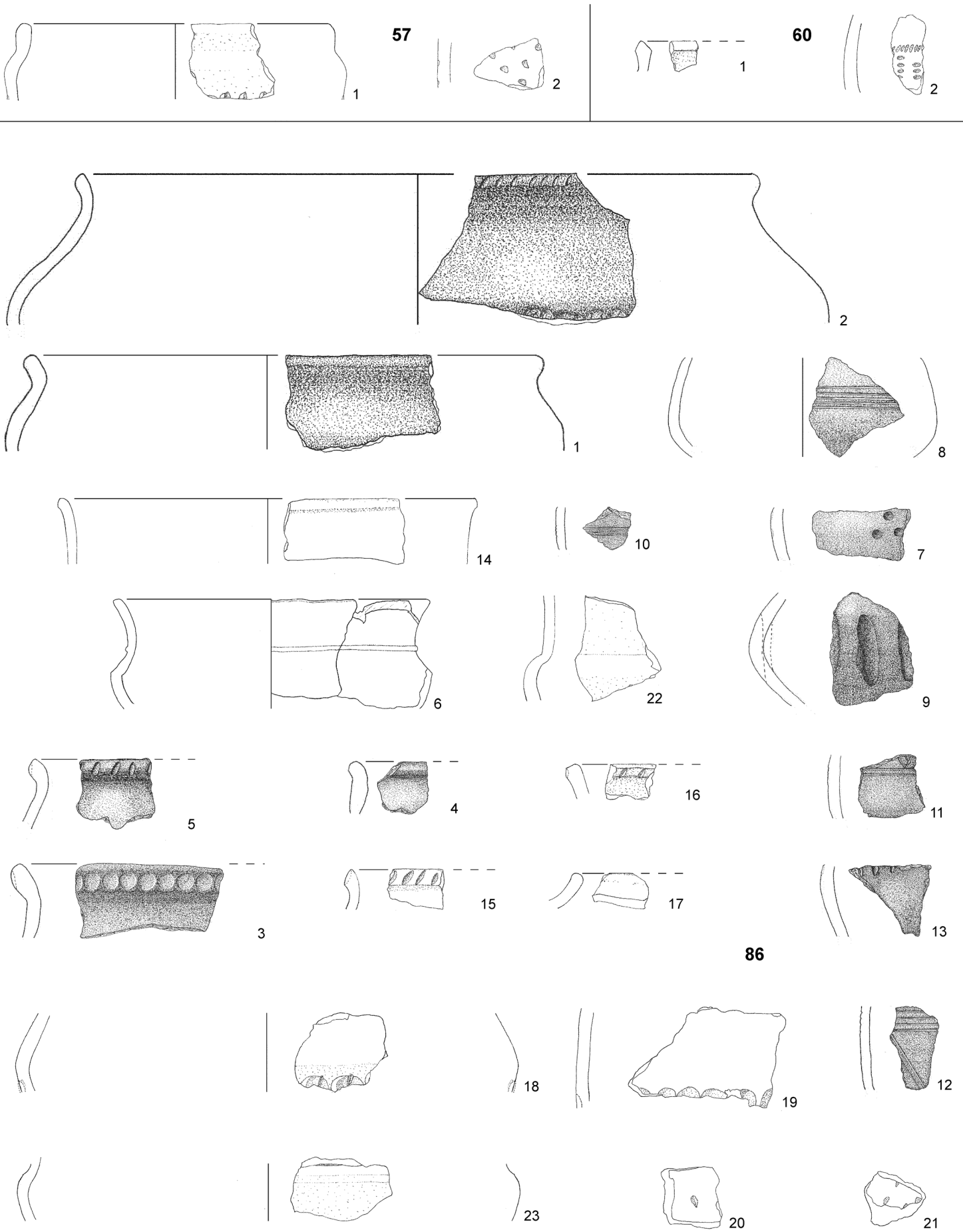

Enger-Ost, Befunde 57, 60 und 86 (F.-Nr. 1-23); M 1:3.

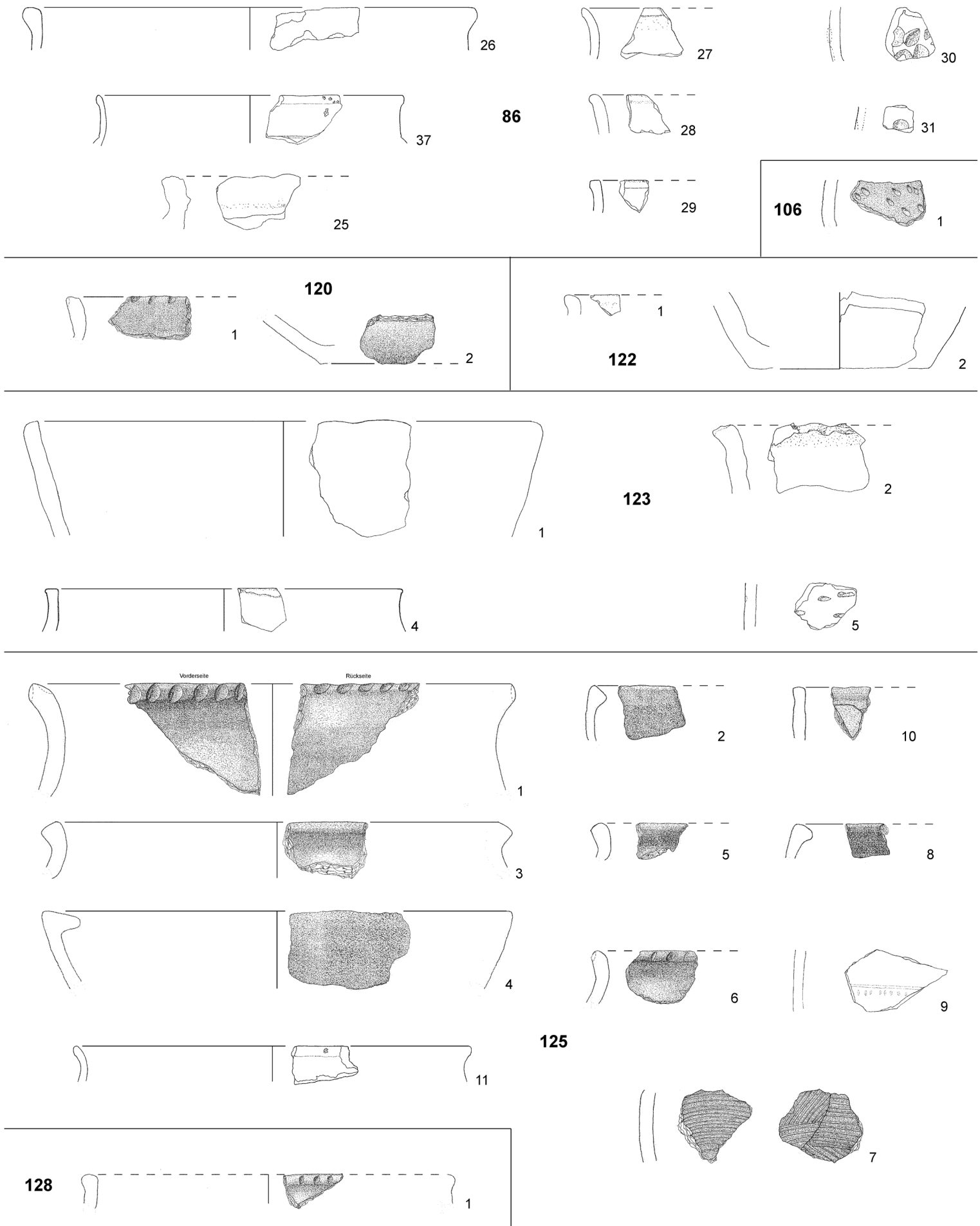

Enger-Ost, Befunde 86 (F.-Nr. 25-37), 120, 122, 123, 125 und 128; M 1:3.

TAFEL 14

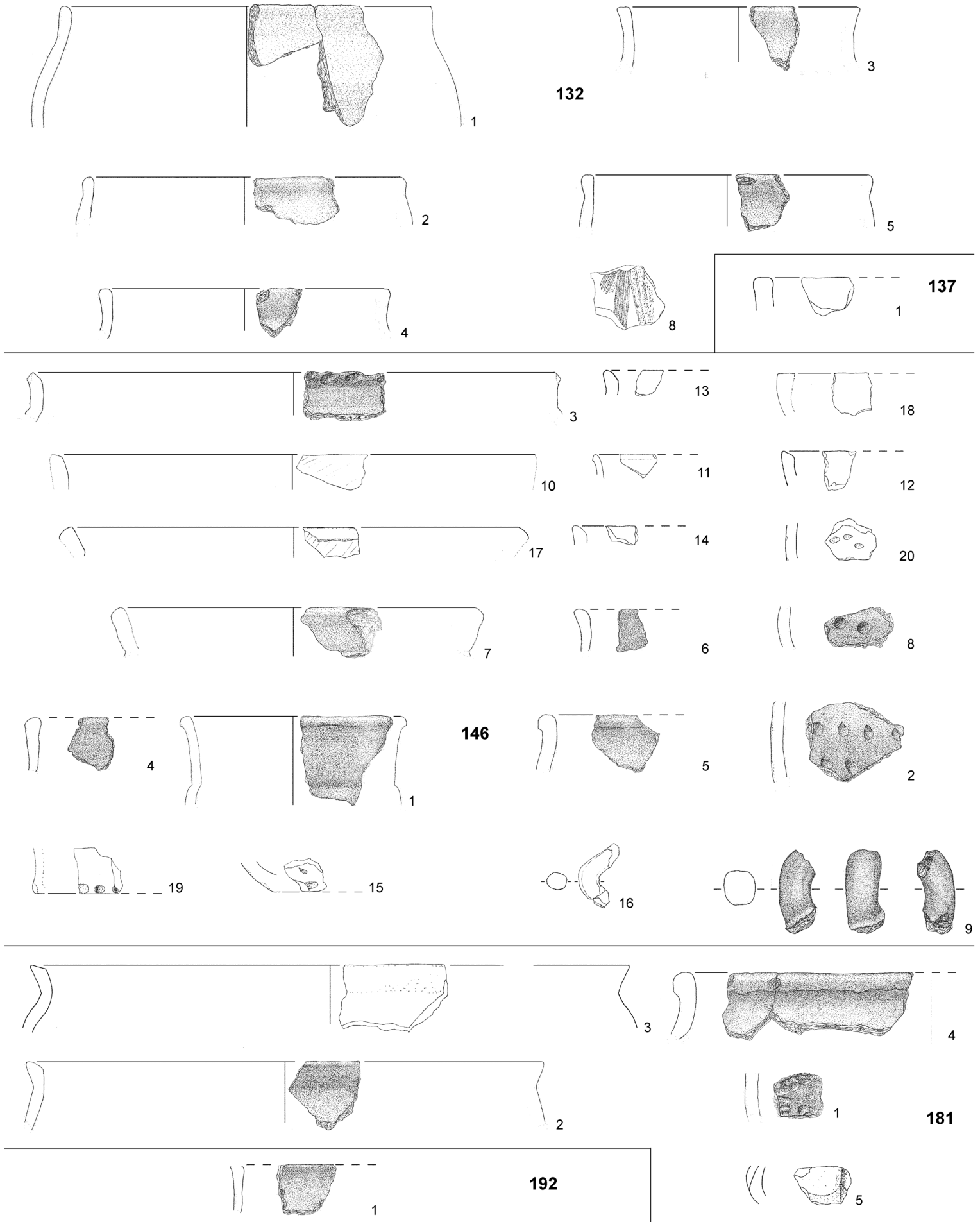

Enger-Ost, Befunde 132, 137, 146, 181 und 192; M 1:3.

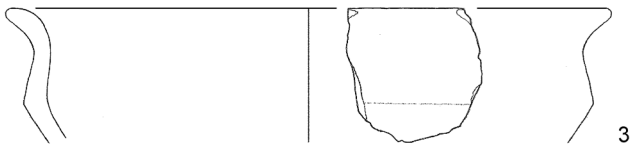
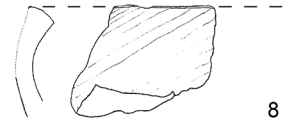
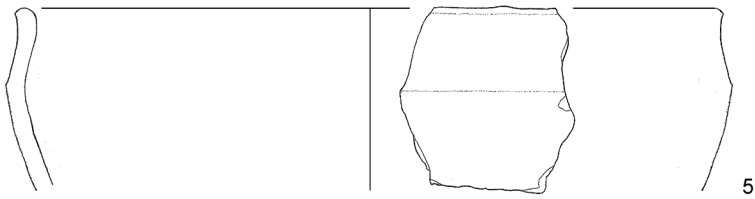
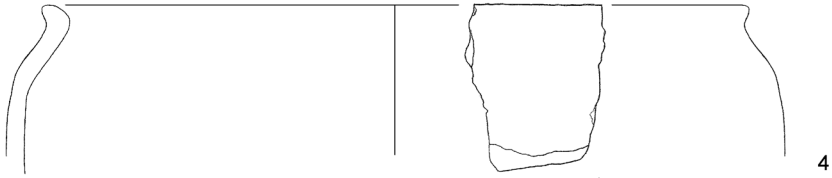
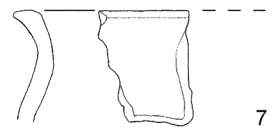
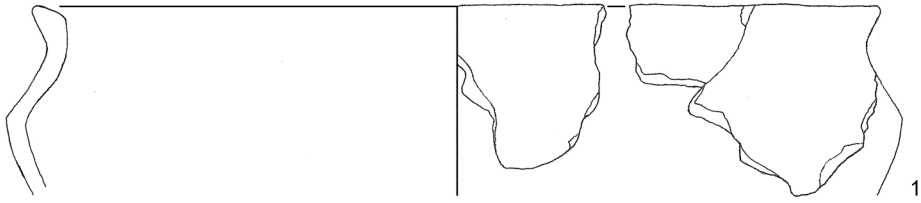

197a

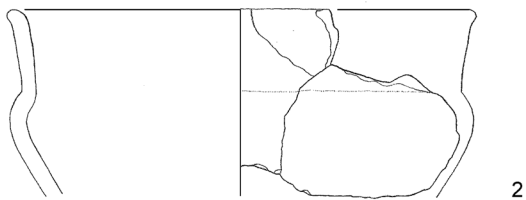

TAFEL 16

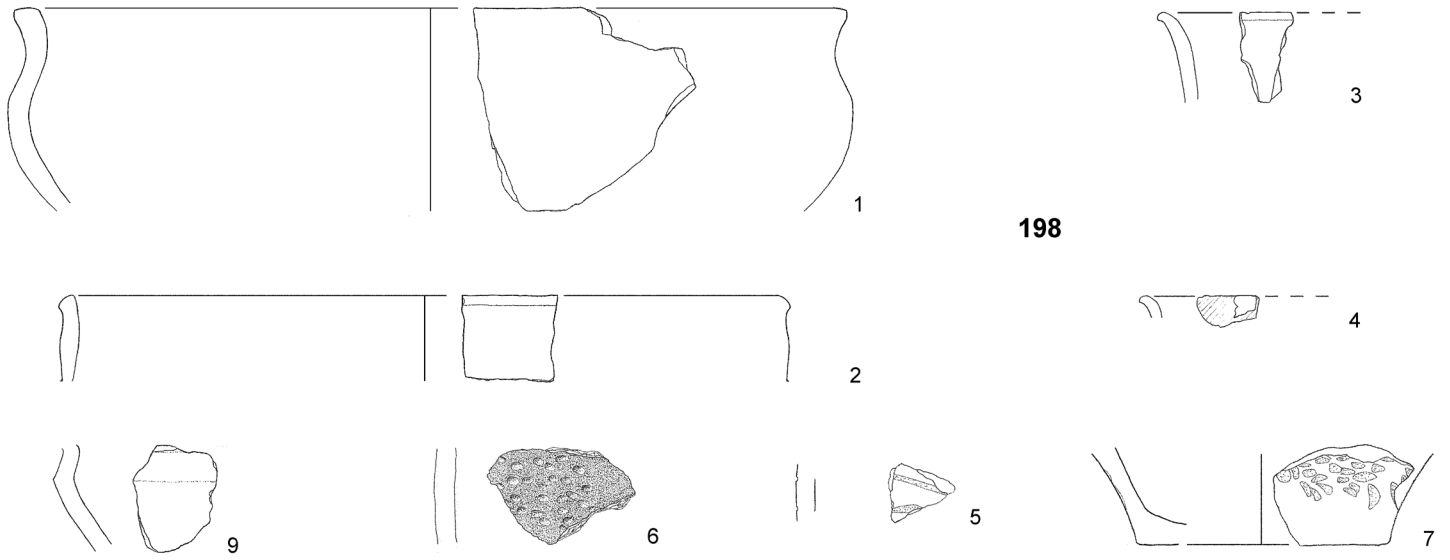

198

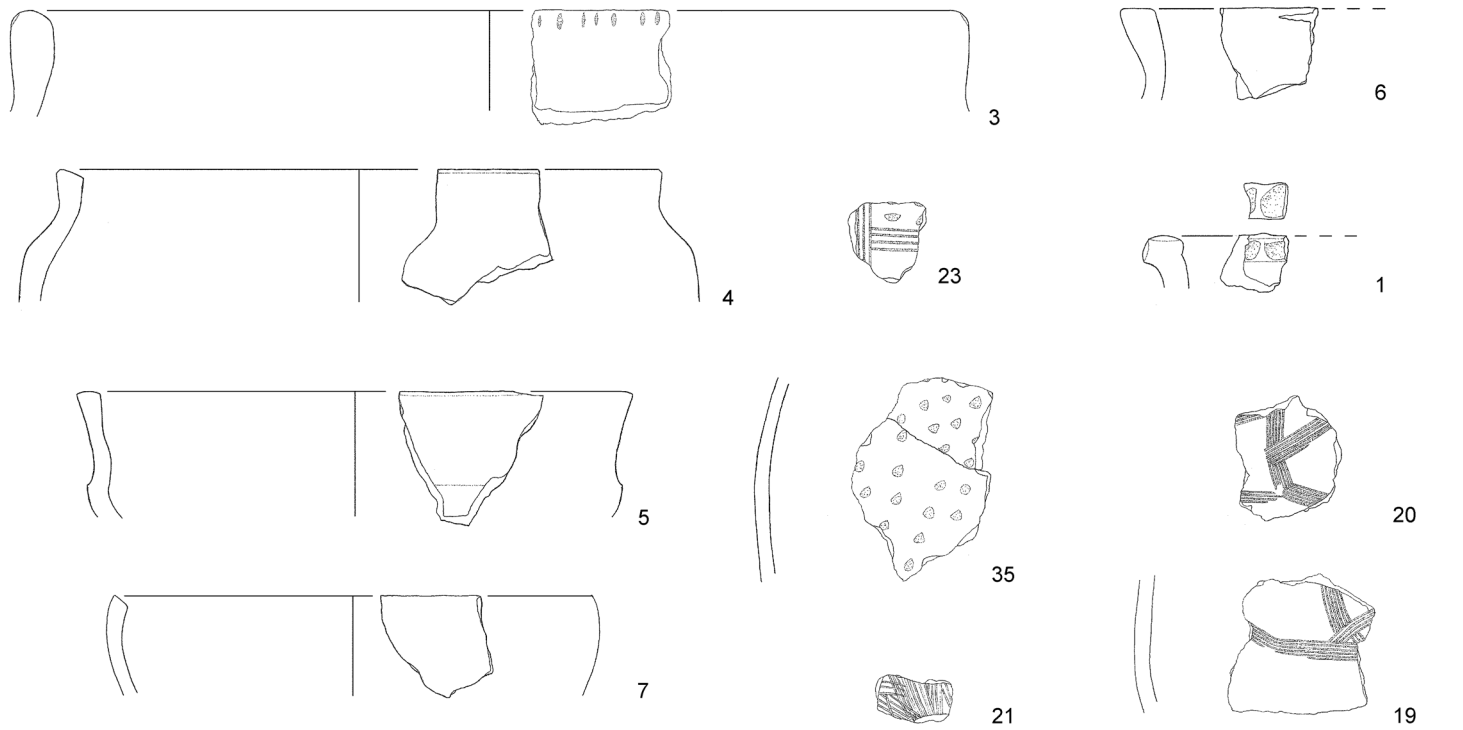

199

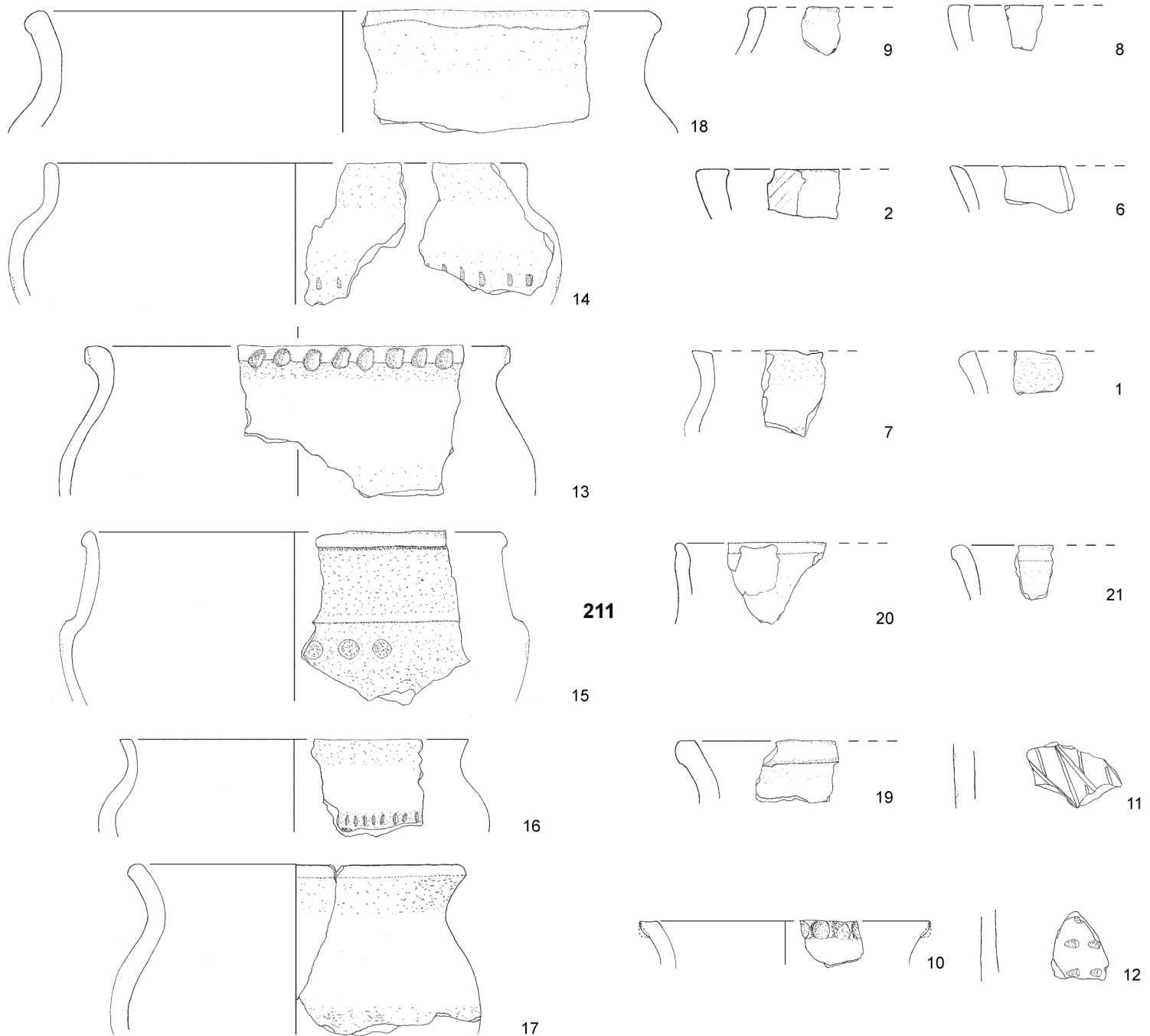
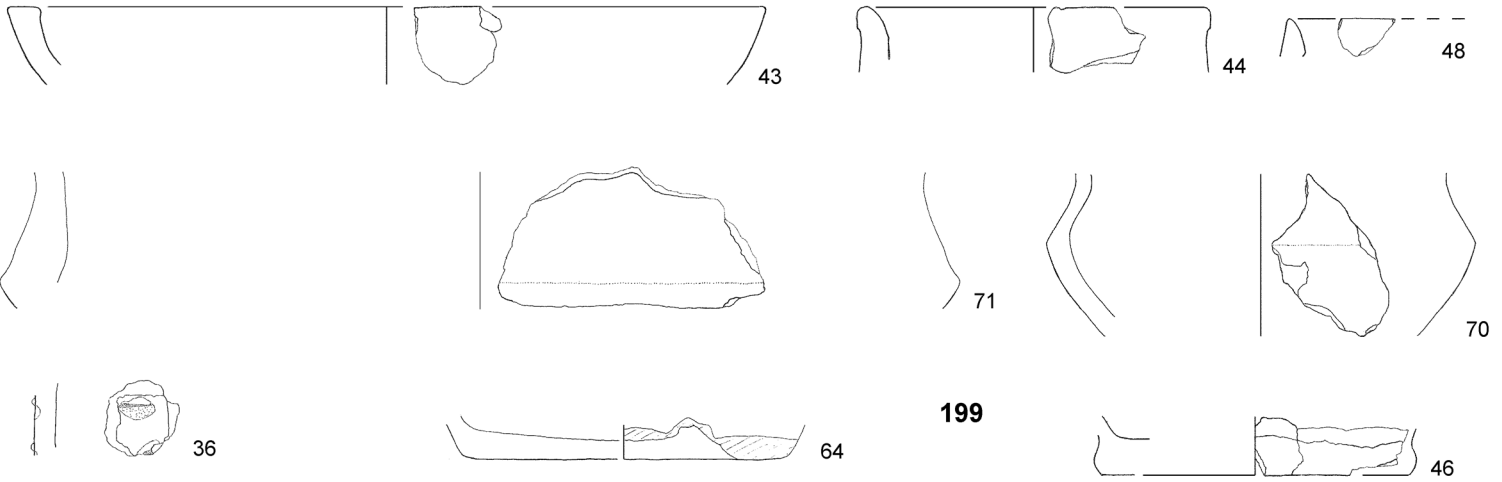

Enger-Ost, Befunde 199 (F.-Nr. 36-71) und 211 (F.-Nr. 1-21): M 1:3.

TAFEL 18

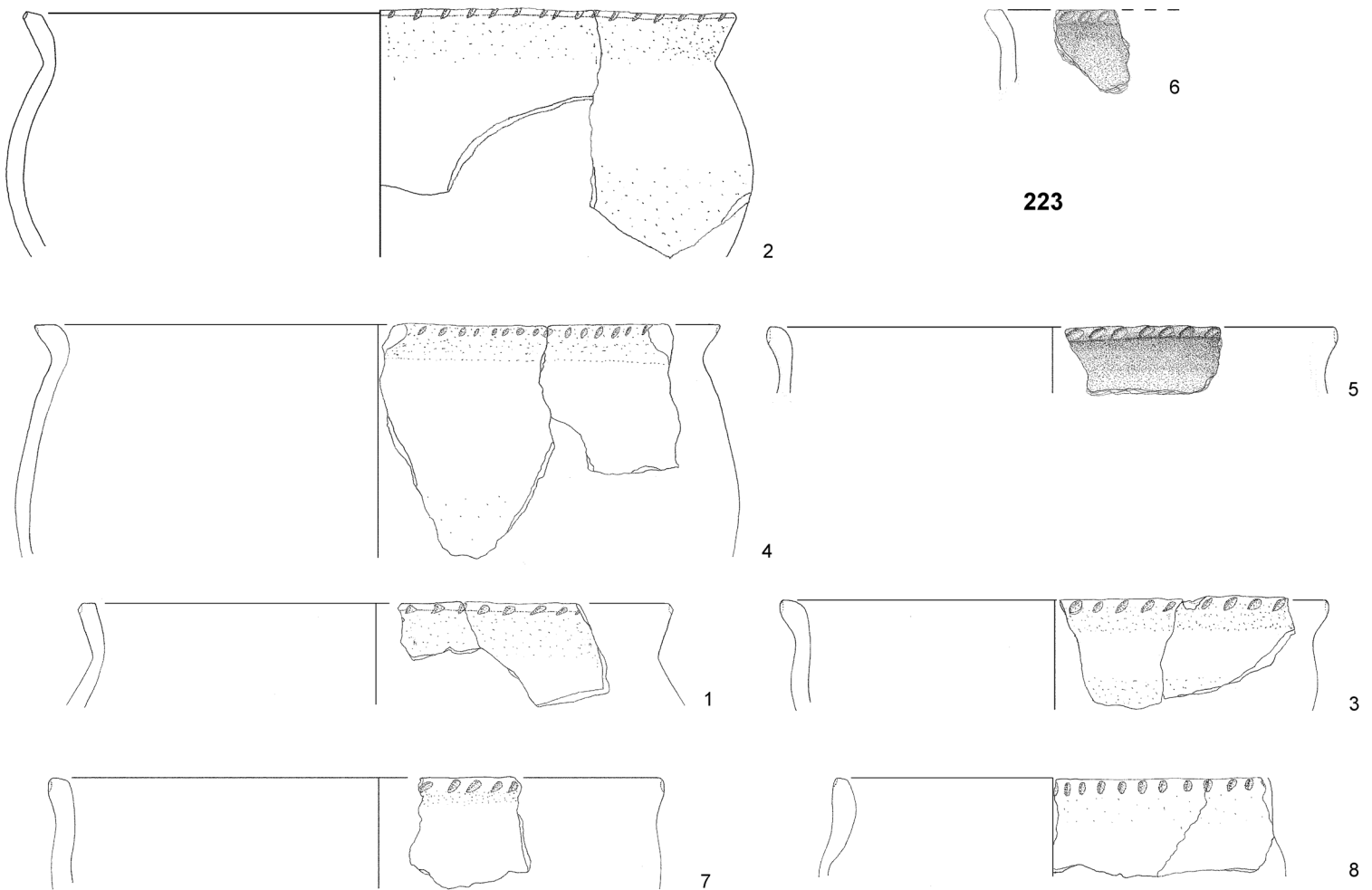
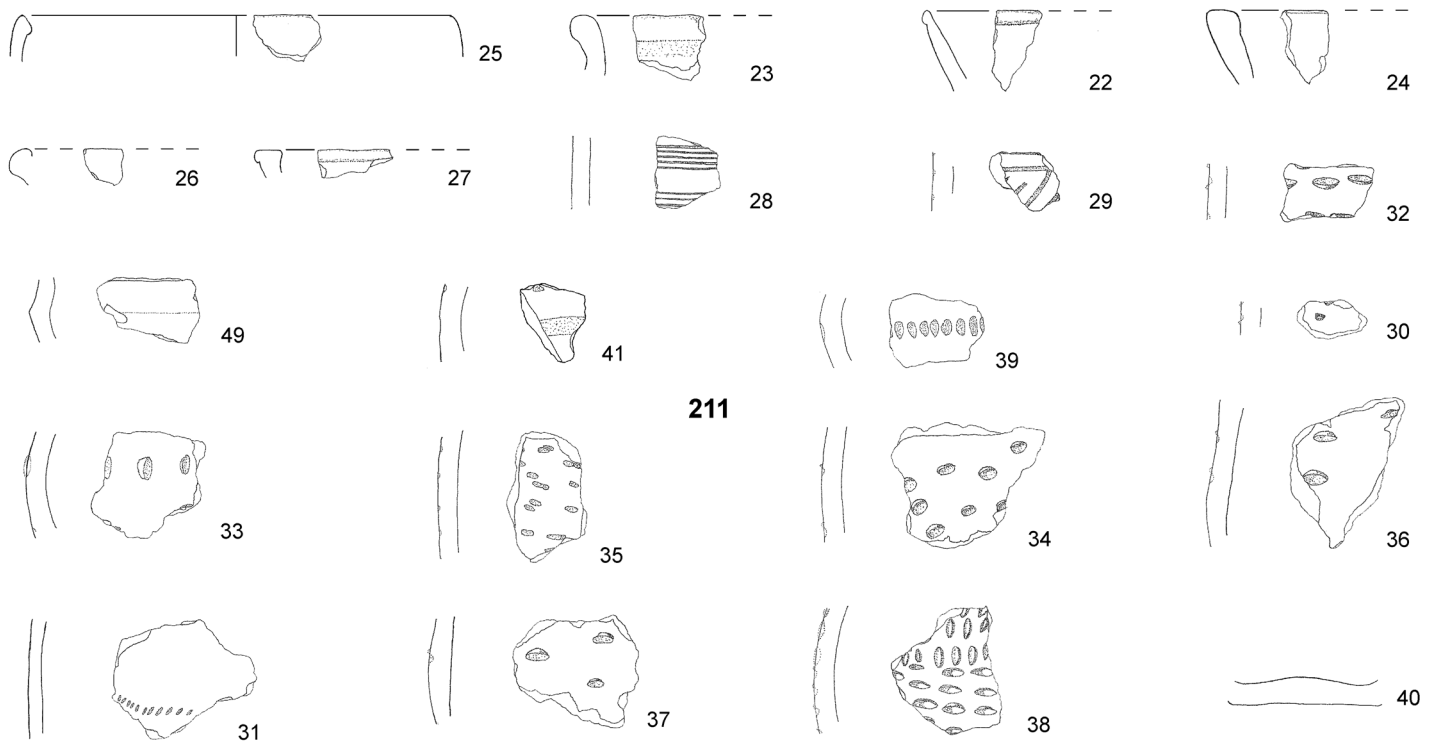

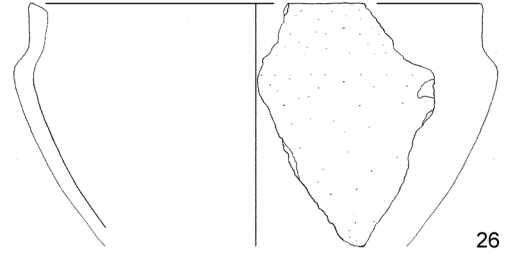
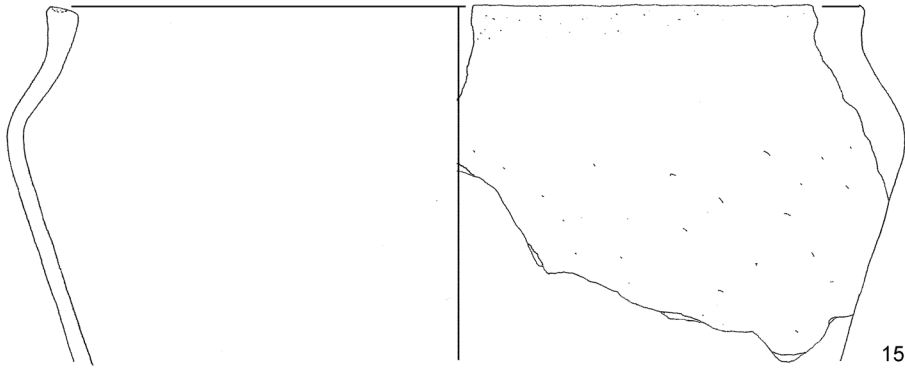
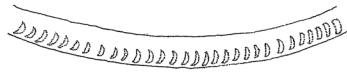

223

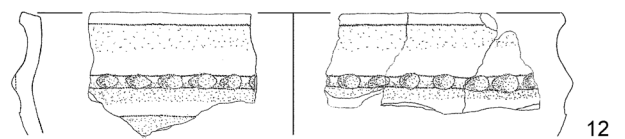
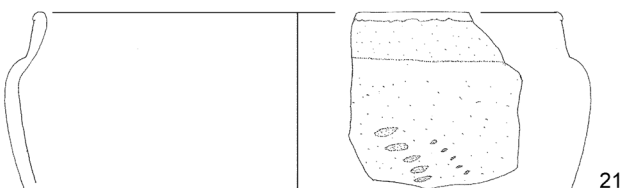
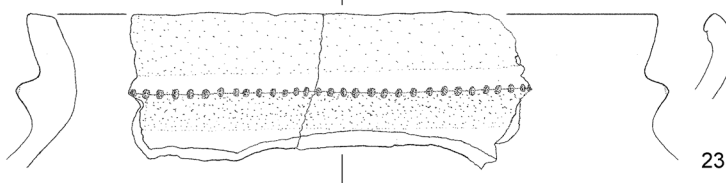
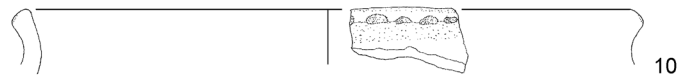
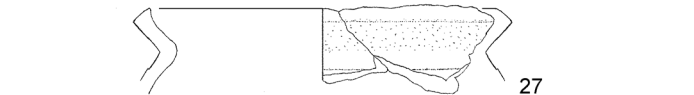
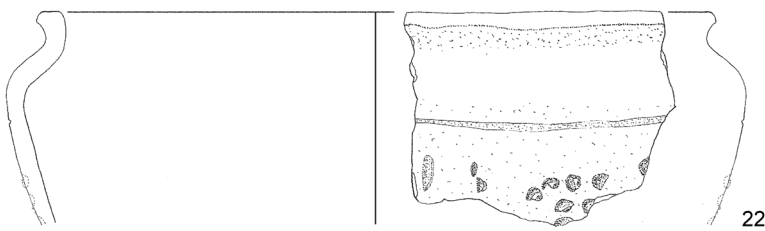
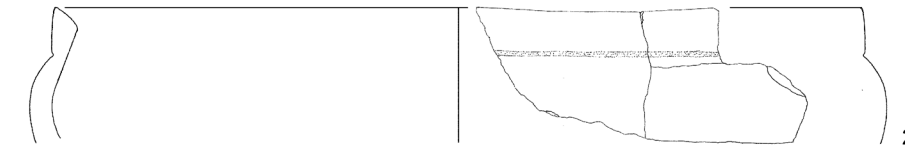
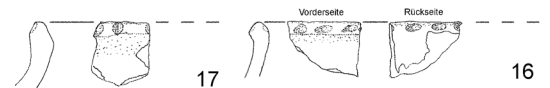
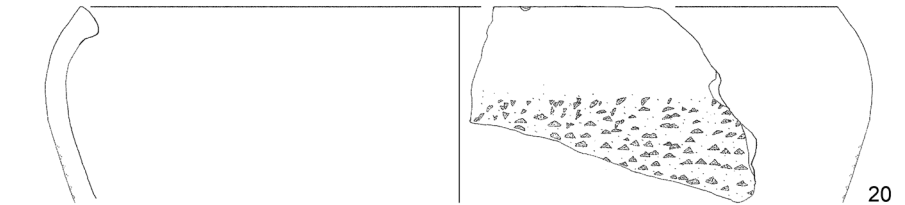
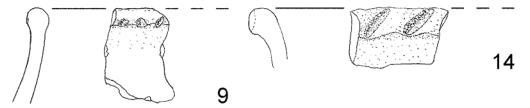
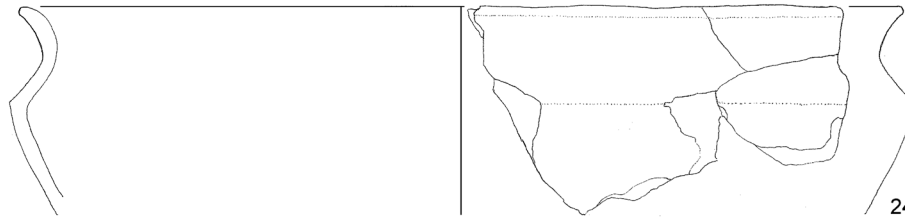
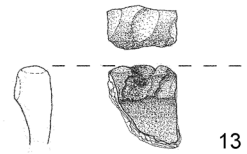

Enger-Ost, Befund 223 (F.-Nr. 9-27); M 1:3.

TAFEL 20

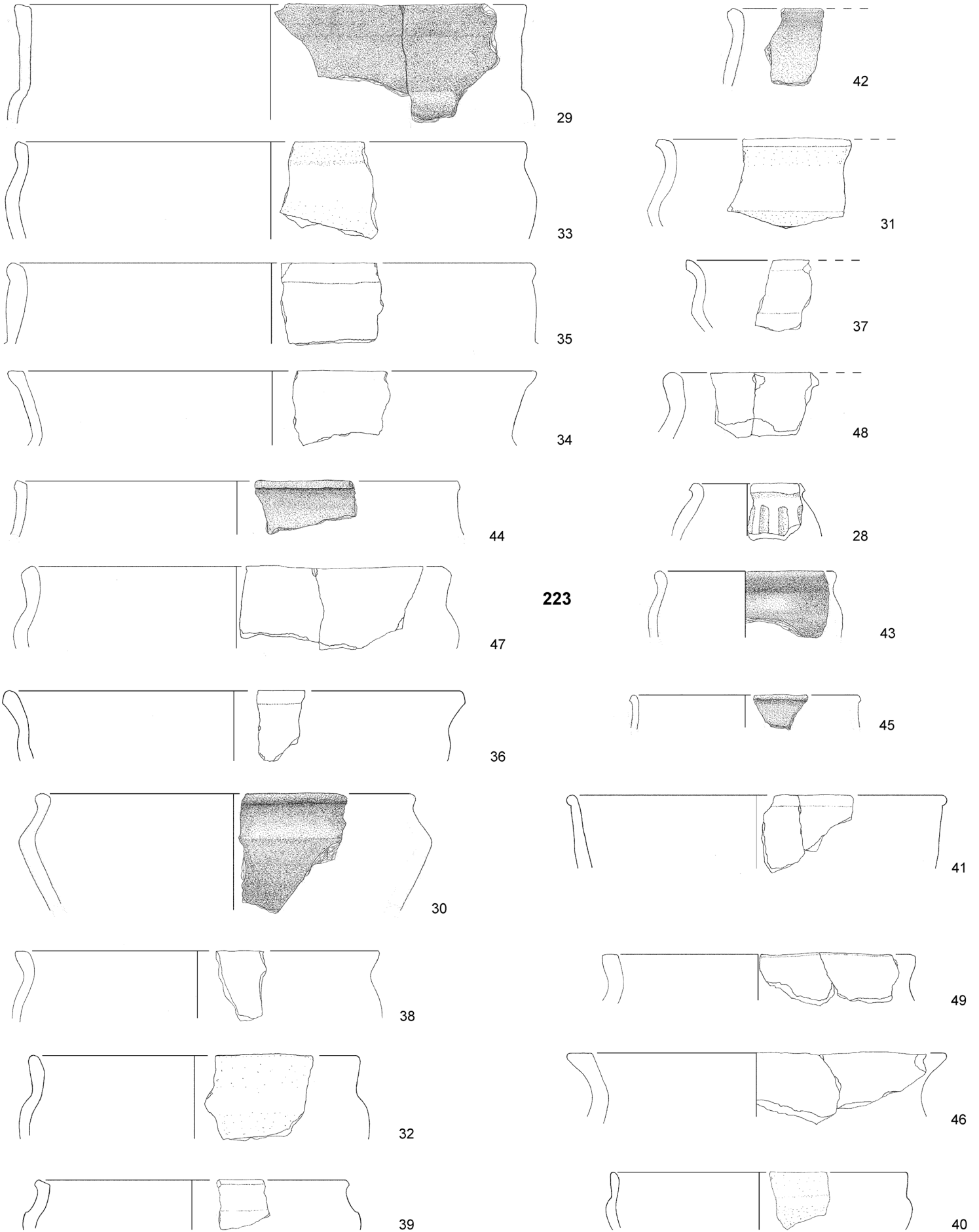

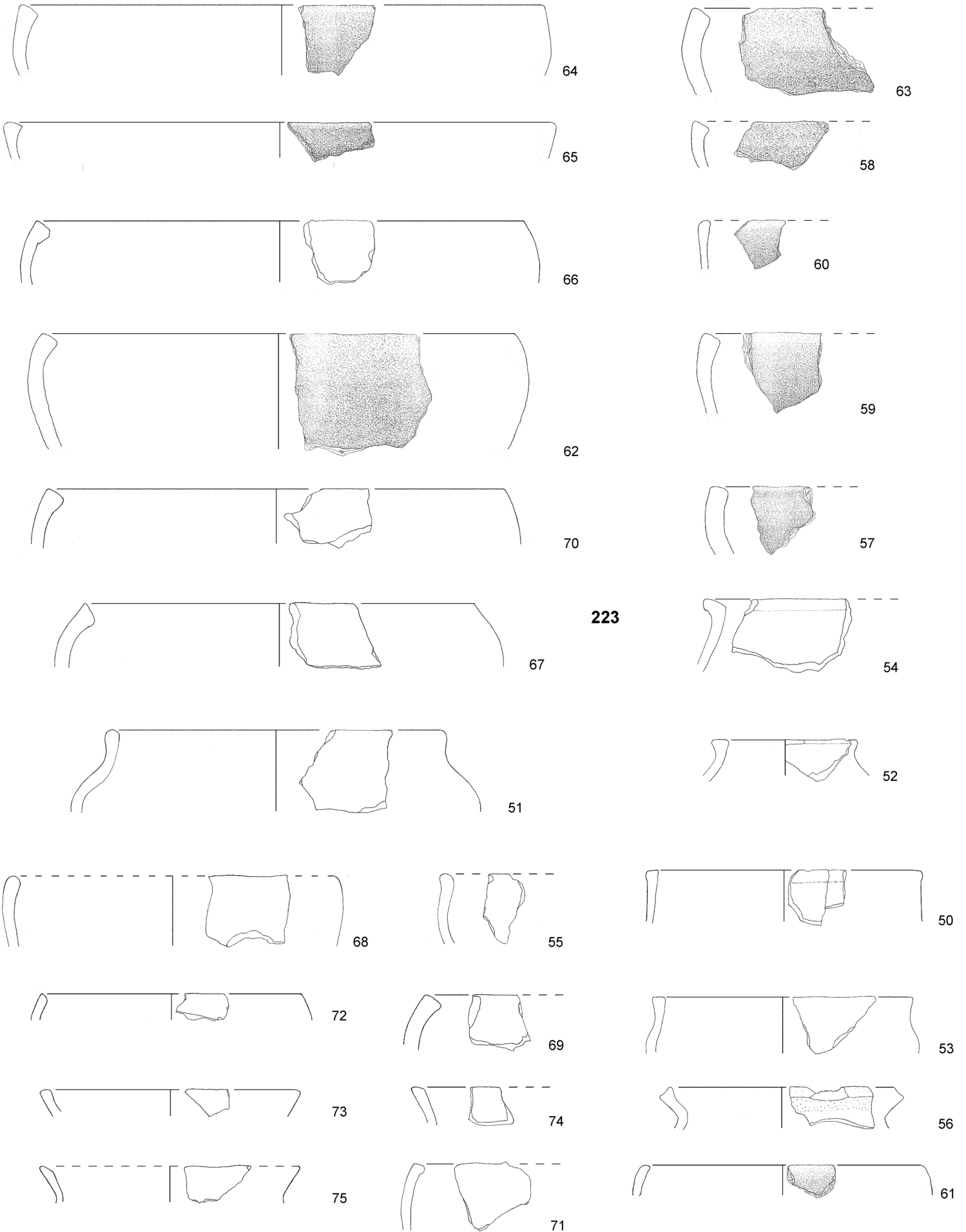

Enger-Ost, Befund 223 (F.-Nr. 50-75); M 1:3.

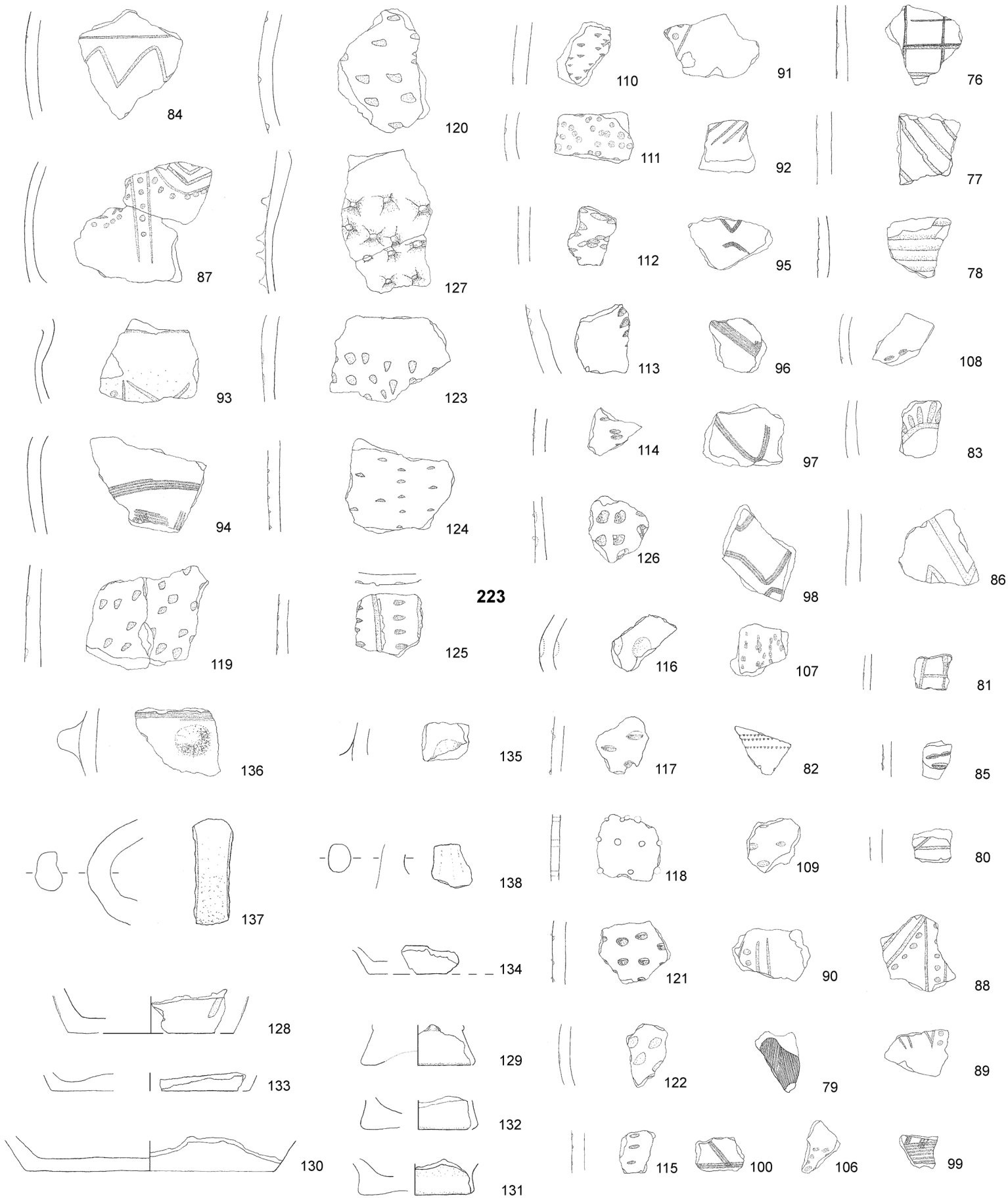

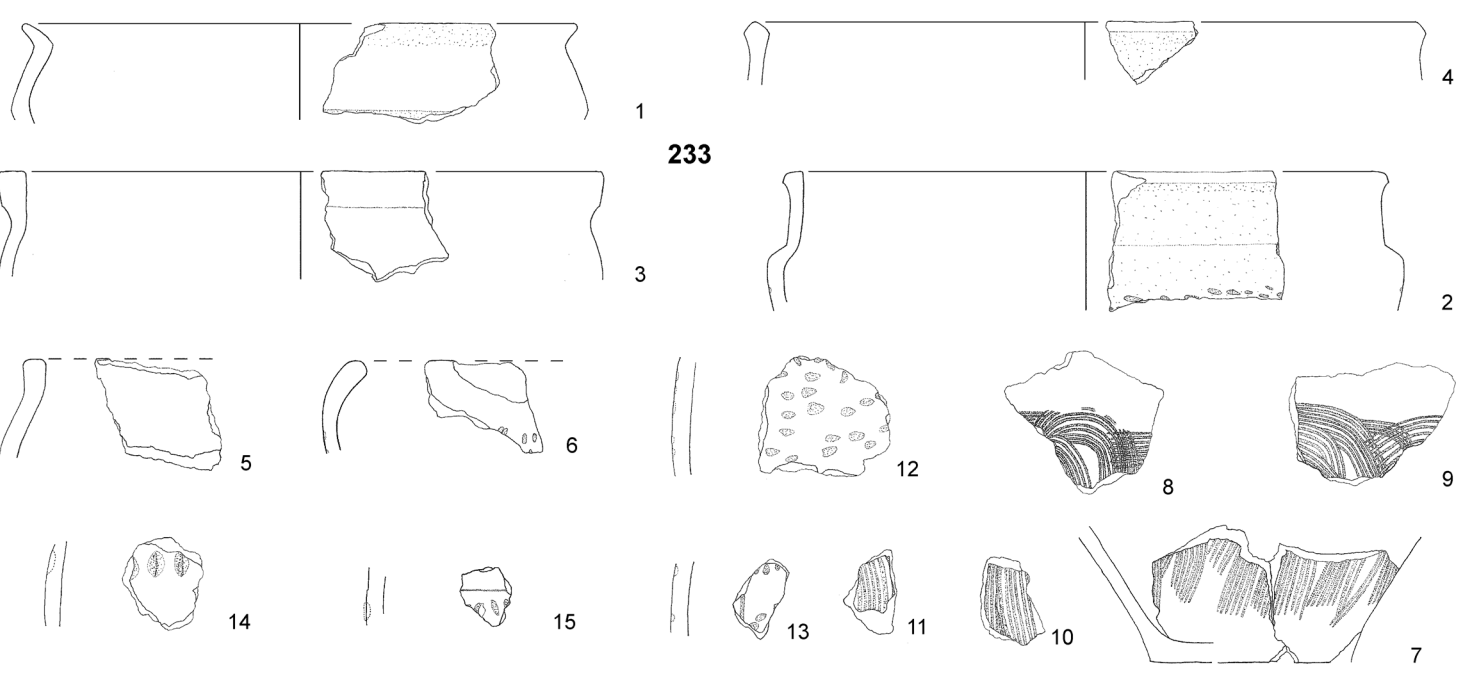
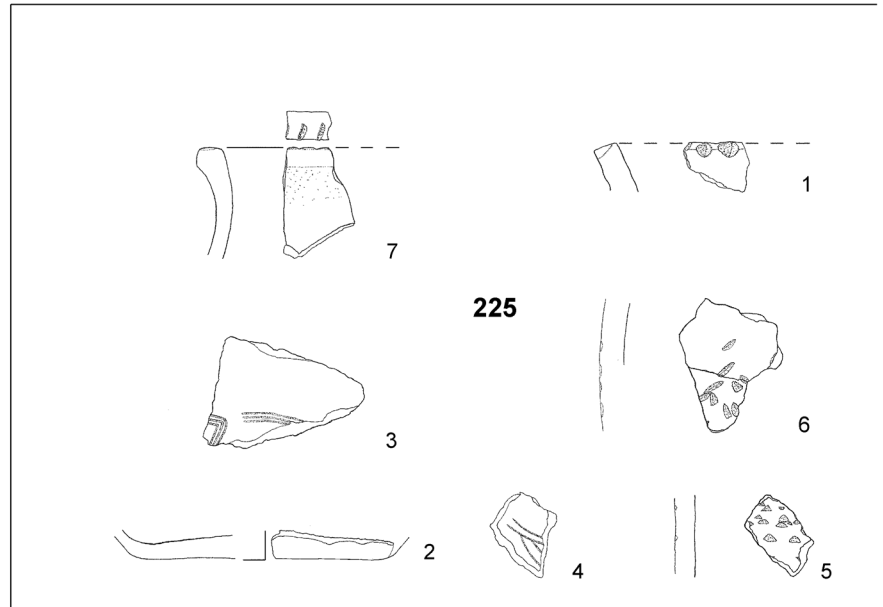
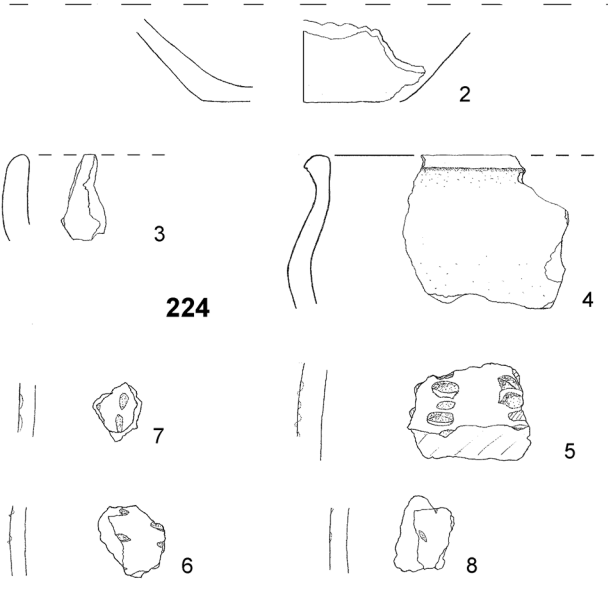
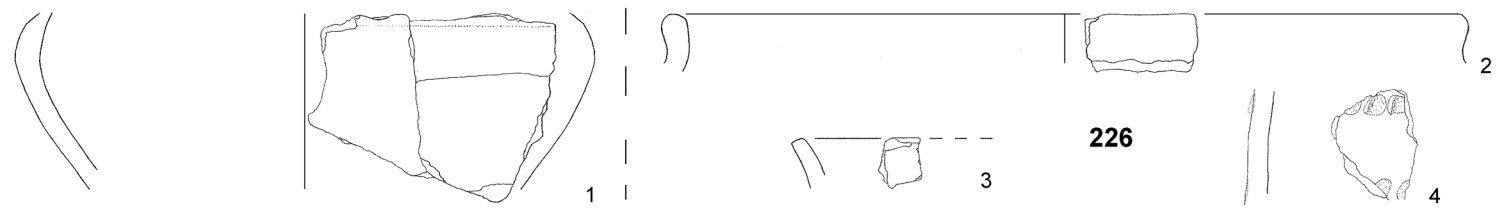
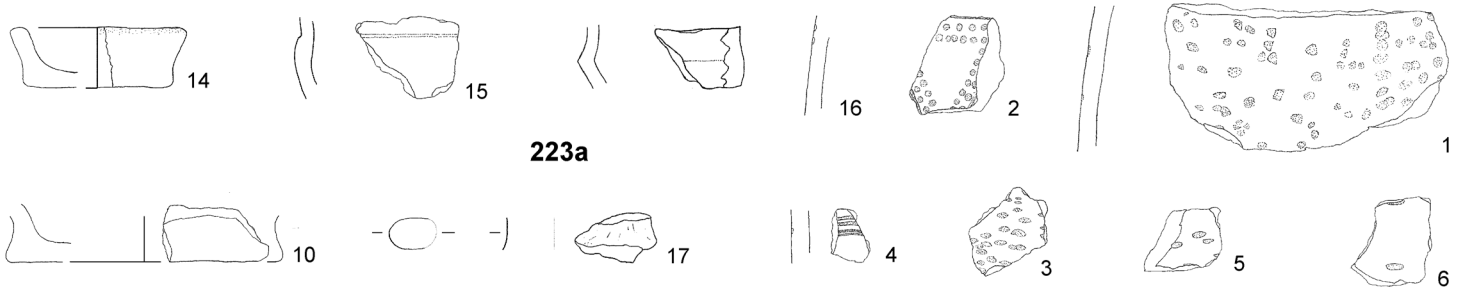

Enger-Ost, Befunde 223a, 224, 225, 226 und 233 (F.-Nr. 1-15); M 1:3.

TAFEL 24

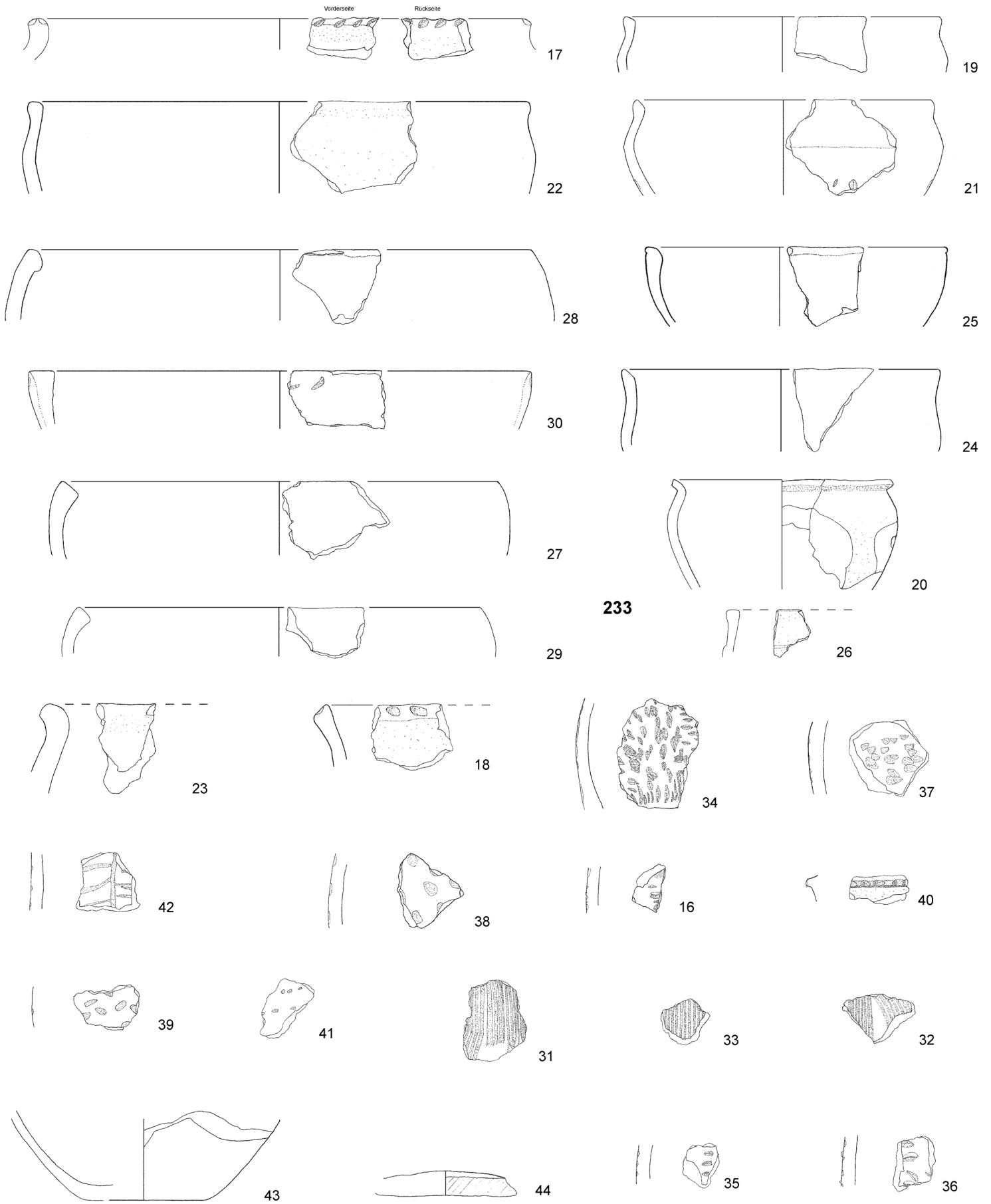

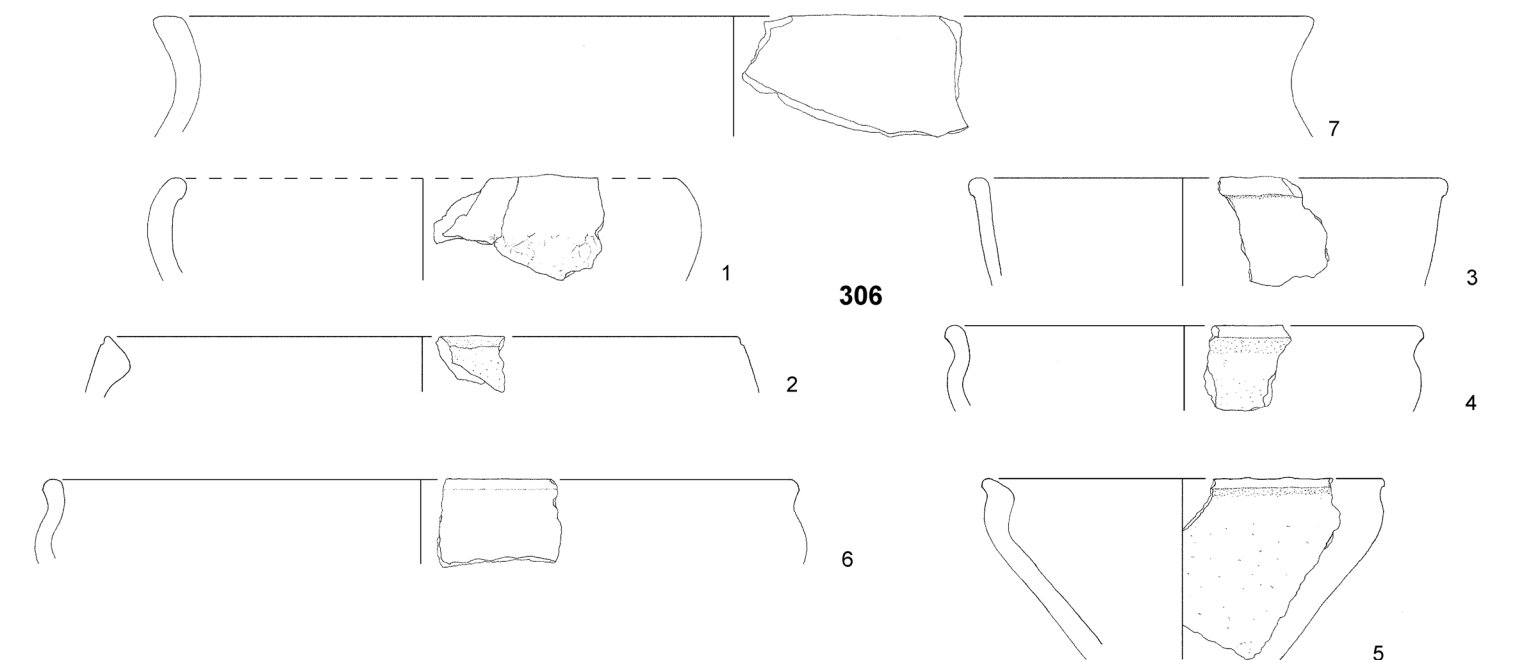
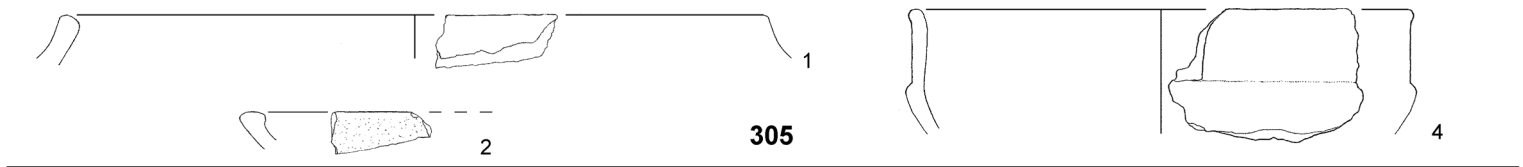
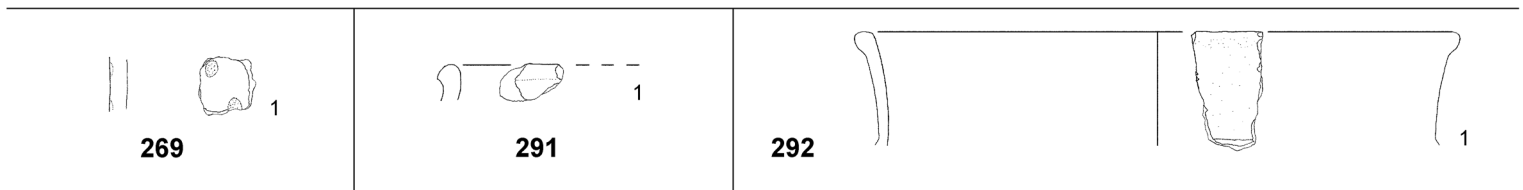
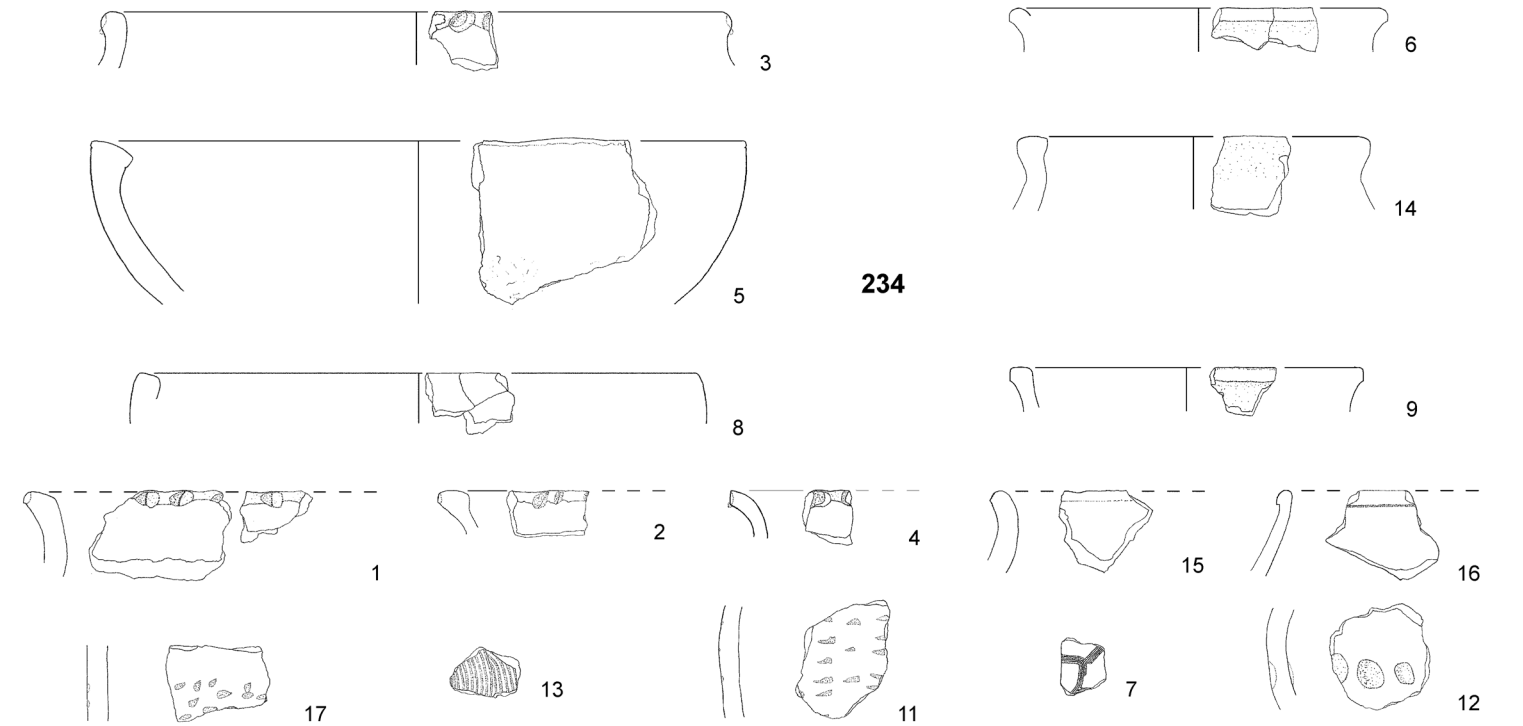

TAFEL 26

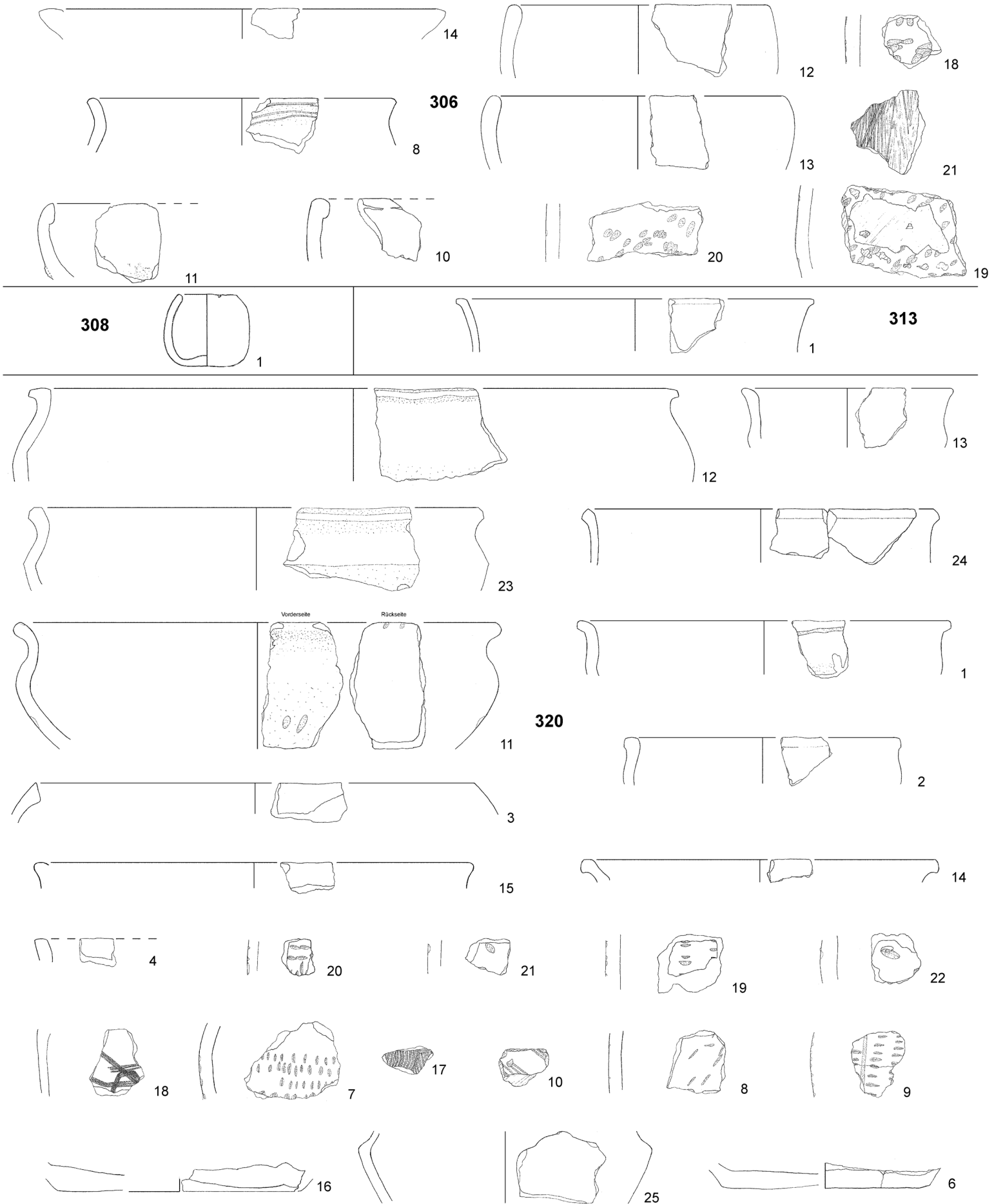

Enger-Ost, Befunde 306 (F.-Nr. 8-21), 308, 313 und 320; M 1:3.

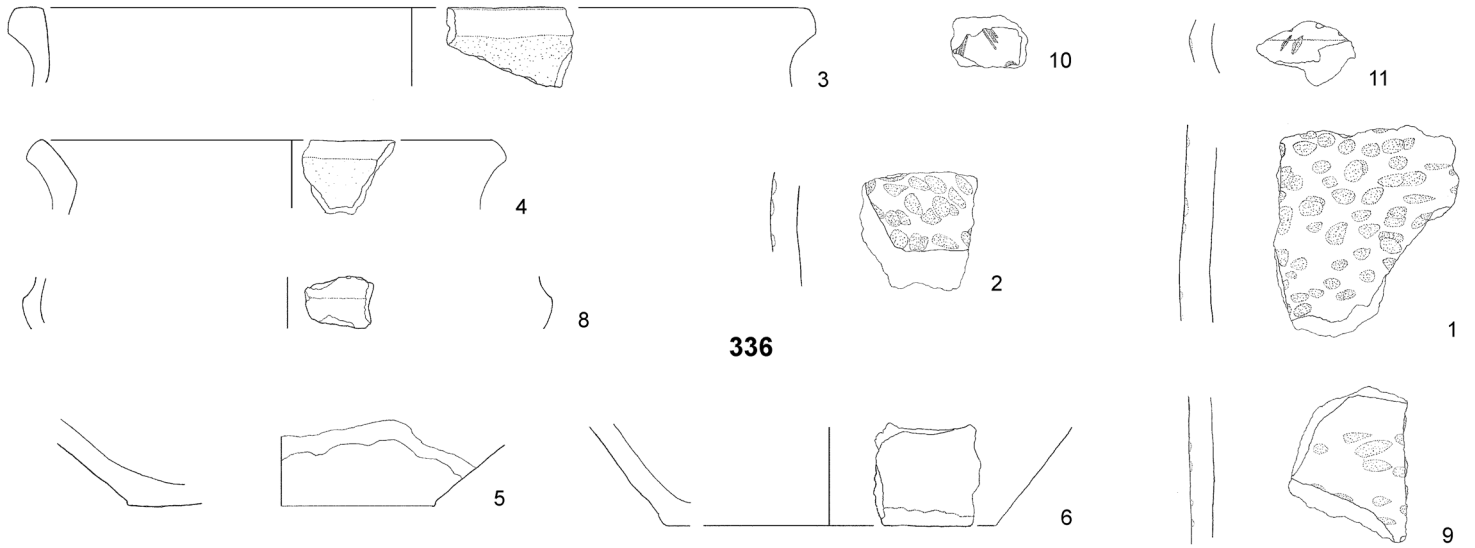

336

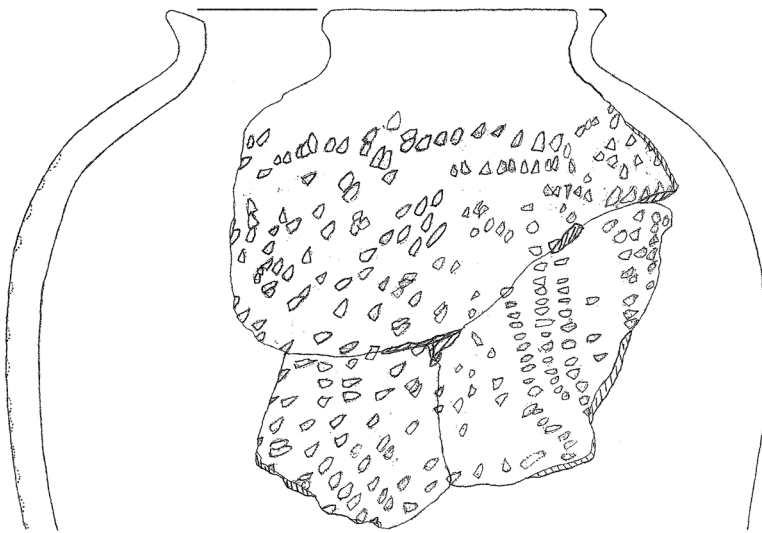

1

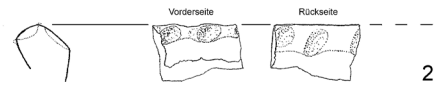

2

337



3

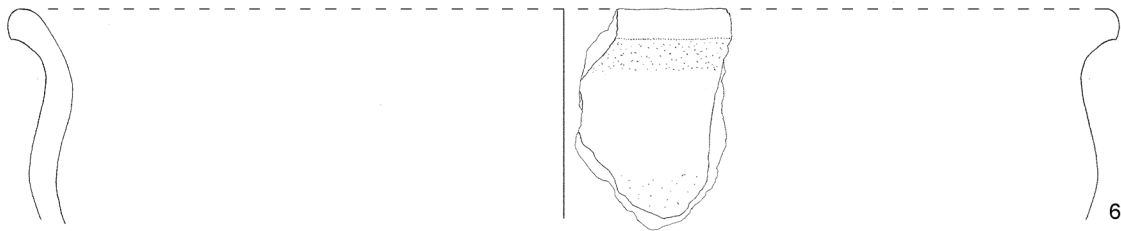

6

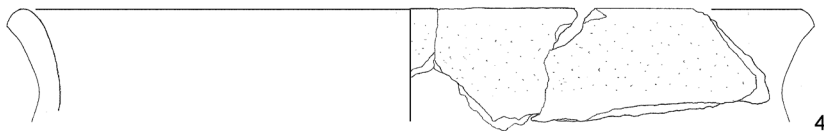

4



5

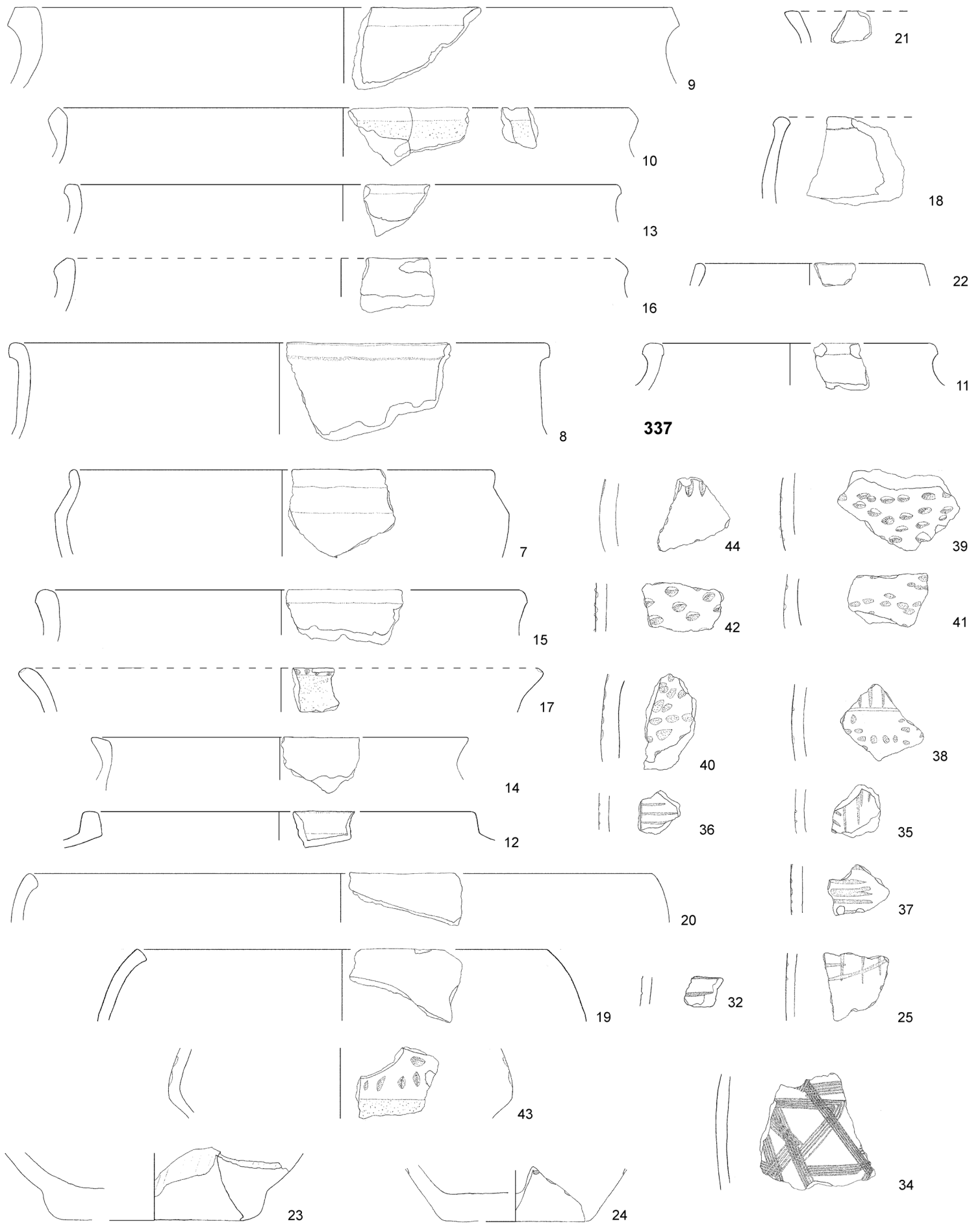

Enger-Ost, Befund 337 (F.-Nr. 7-44); M 1:3.

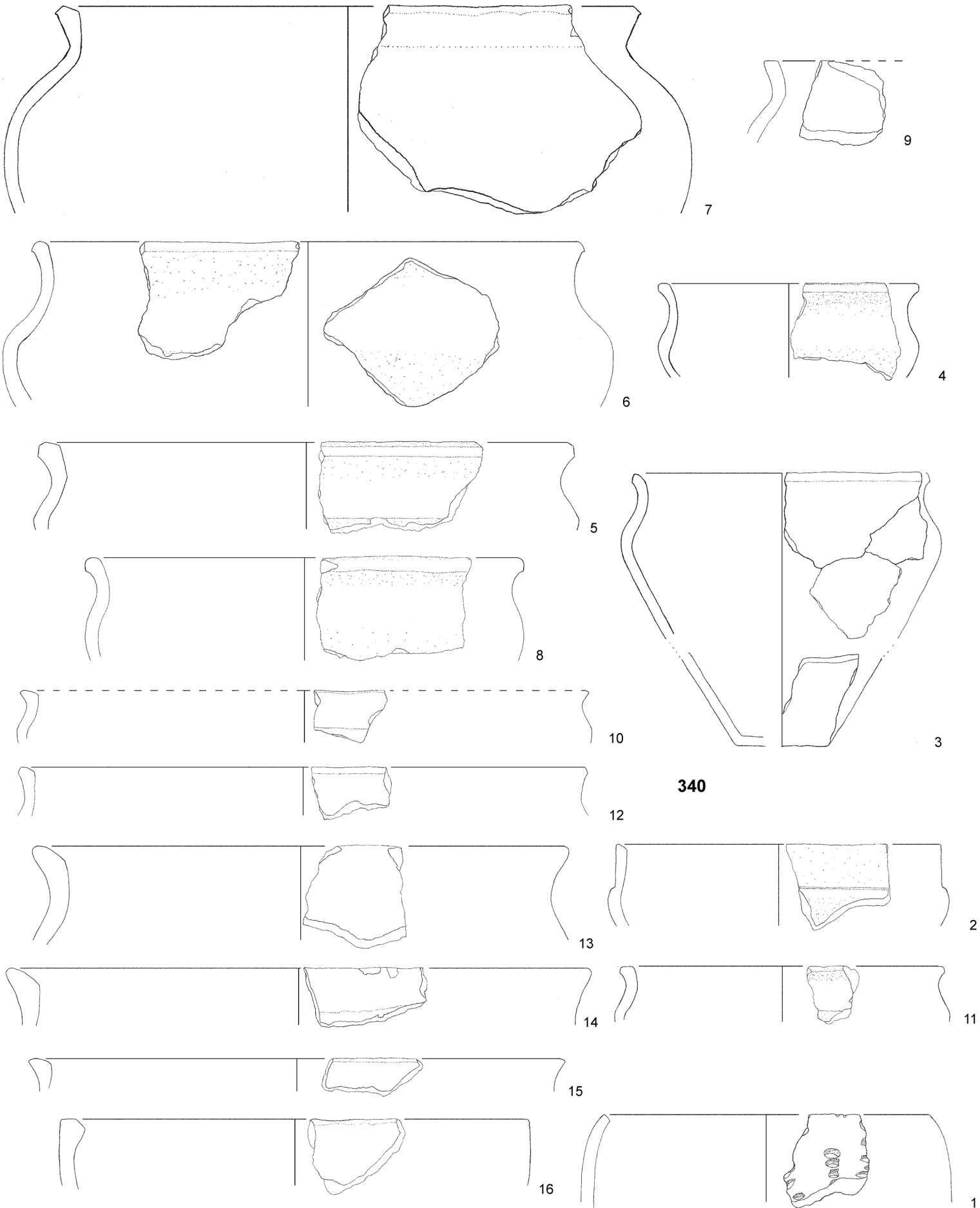

Enger-Ost, Befund 340 (F.-Nr. 1-16); M 1:3.

TAFEL 30

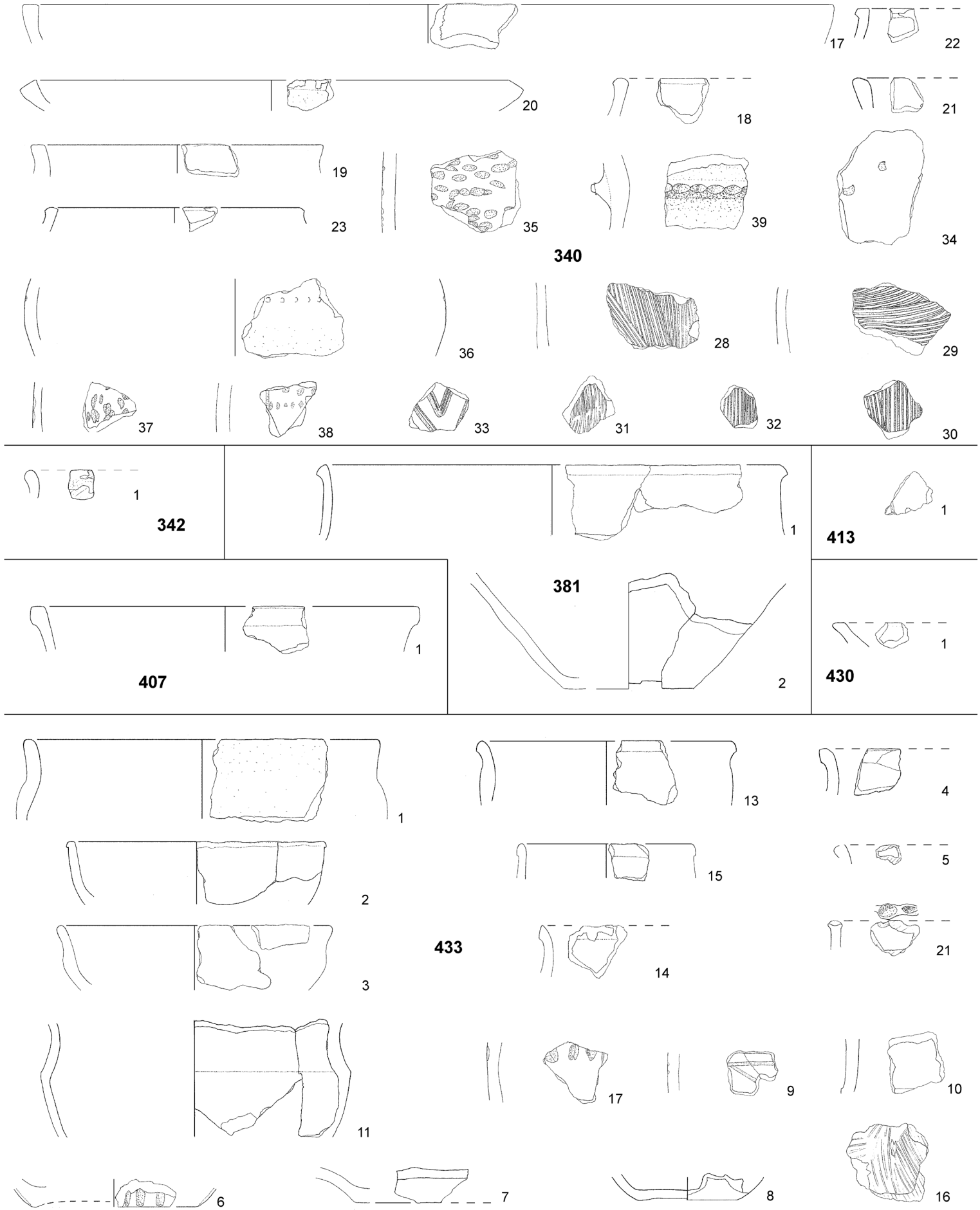

Enger-Ost, Befunde 340 (F.-Nr. 17-39), 342, 381, 407, 413, 430 und 433 (F.-Nr. 1-21); M 1:3.

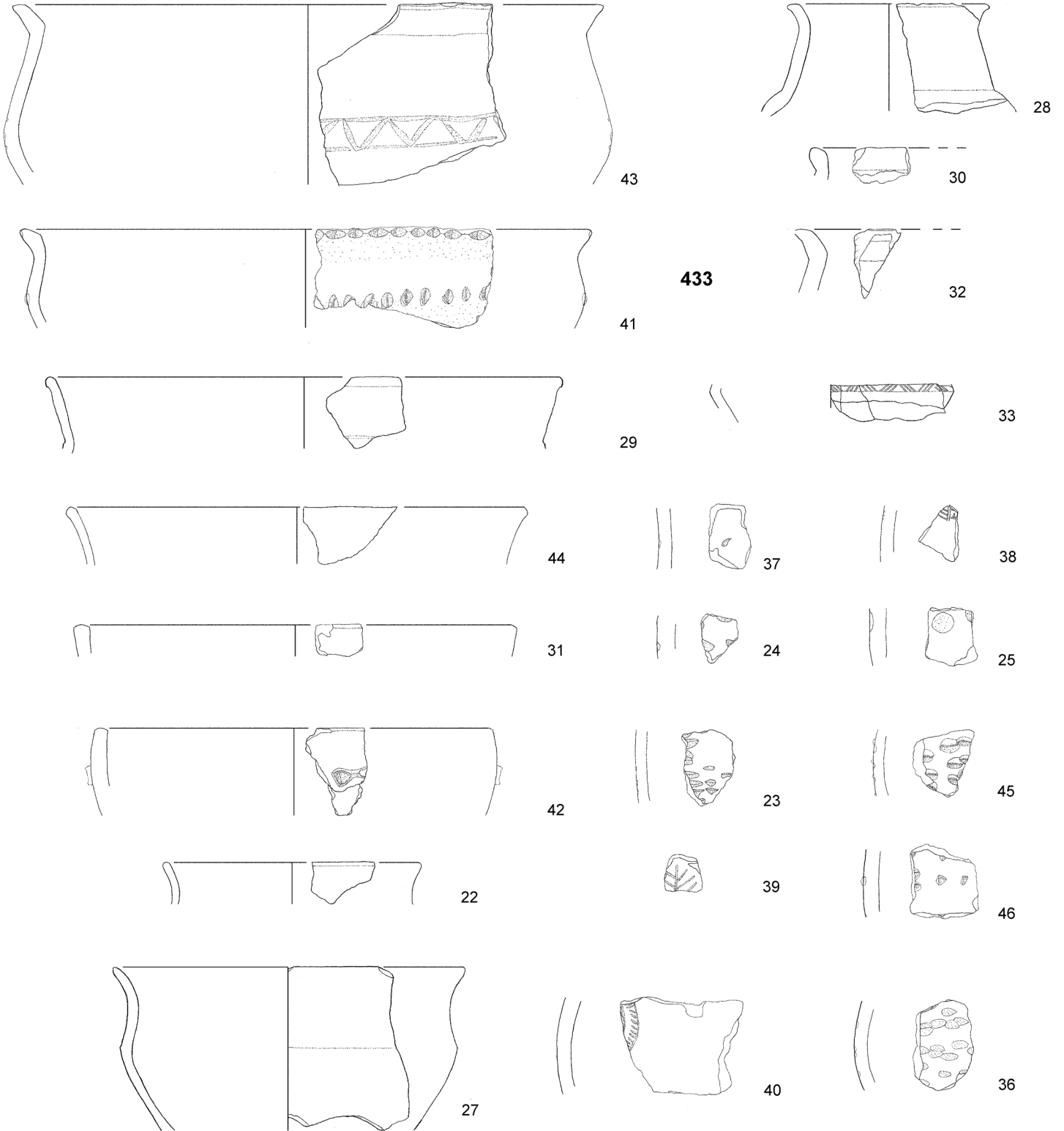

434



437



TAFEL 32

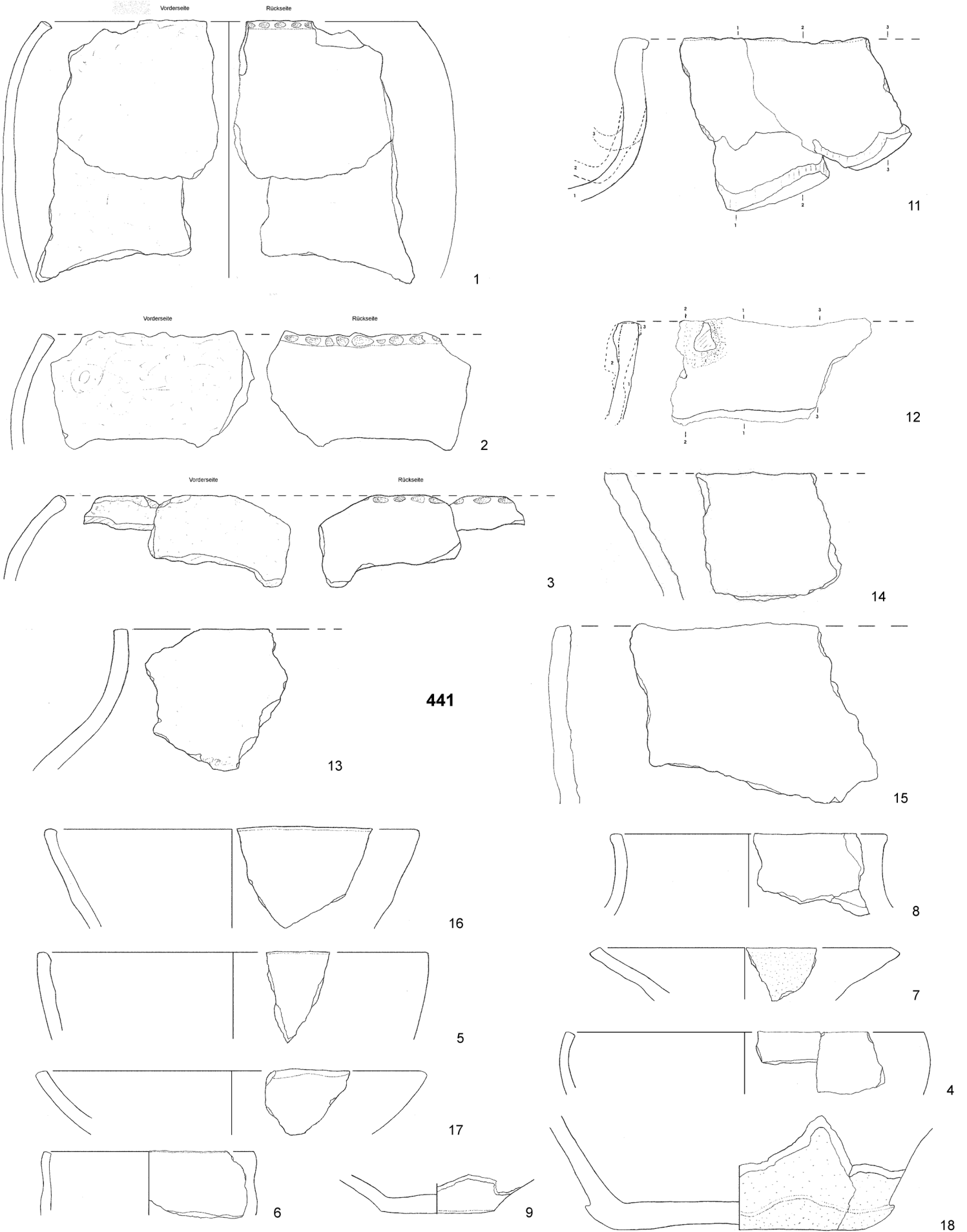

441

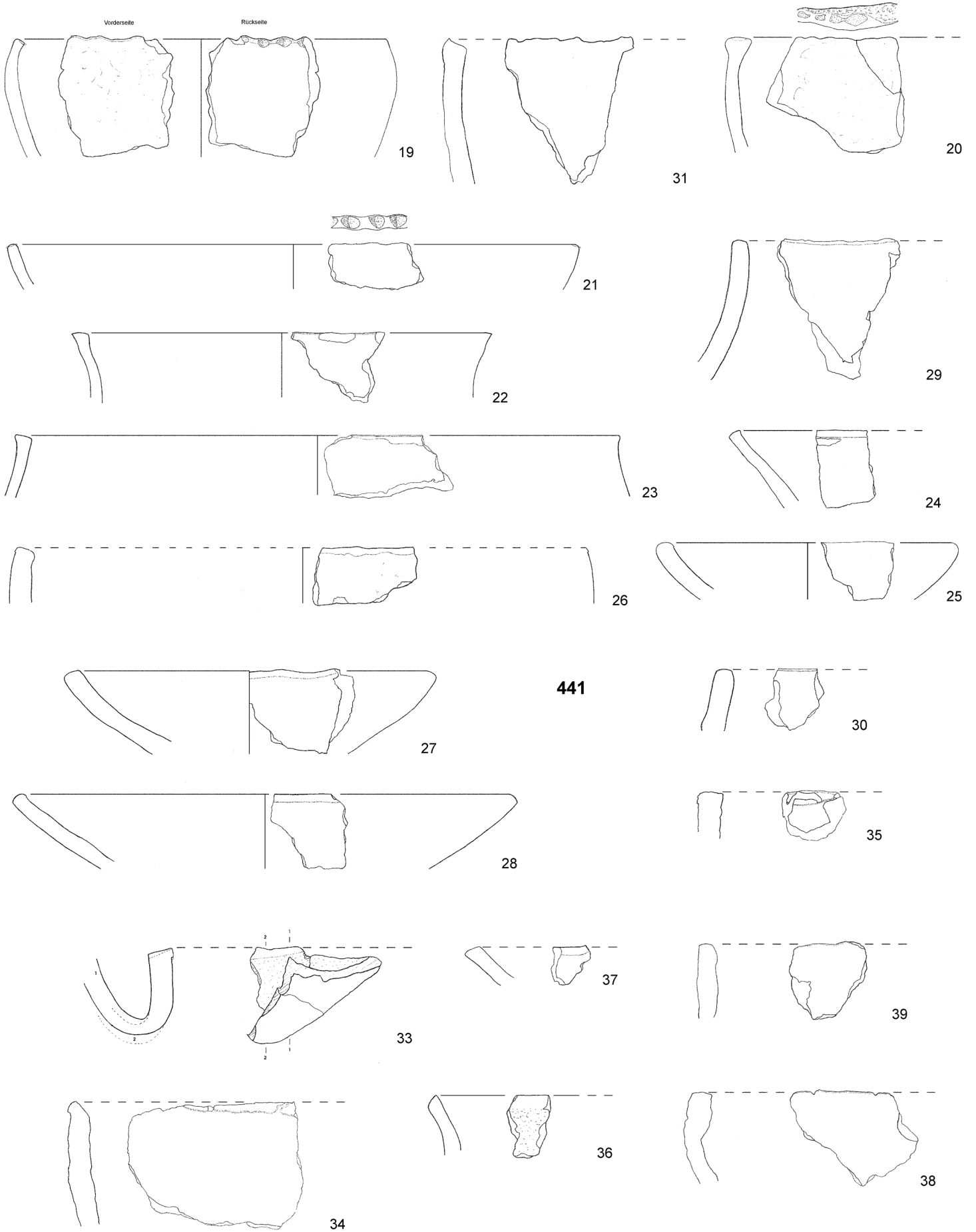

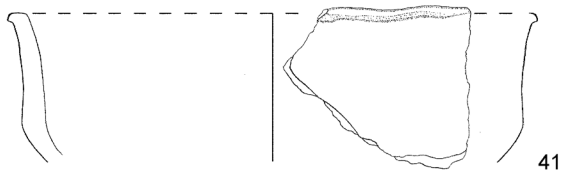
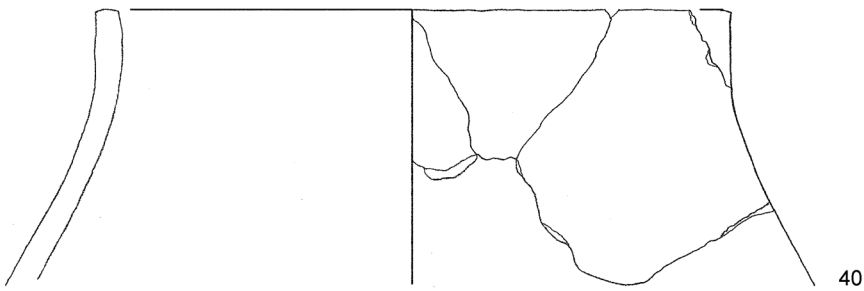

441

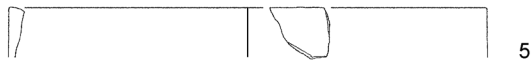
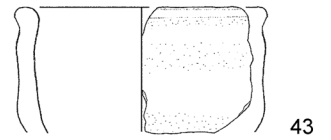

442

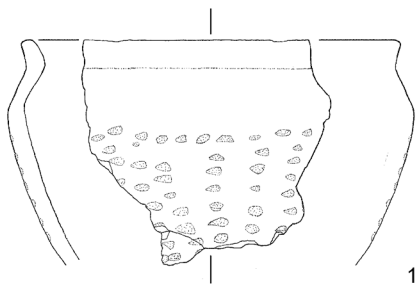
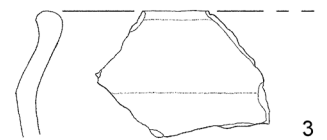
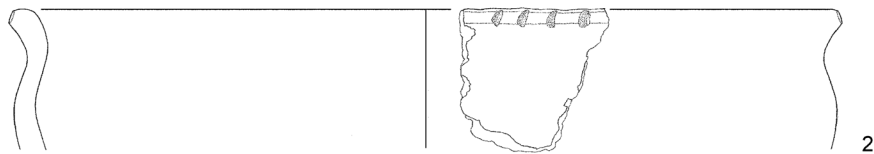

443

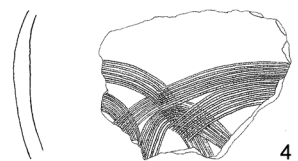
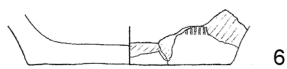

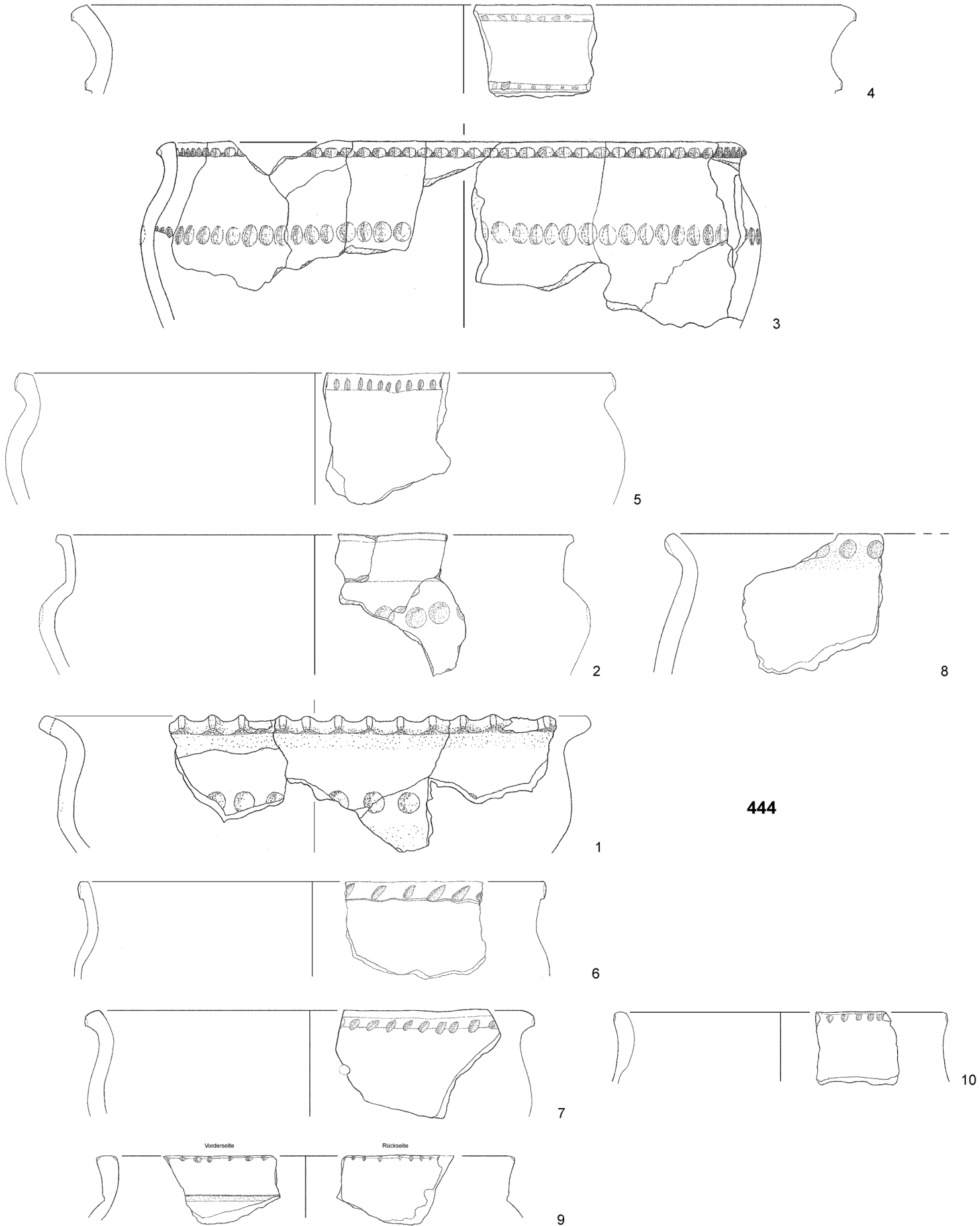

Enger-Ost, Befund 444 (F.-Nr. 1-10; M 1:3.

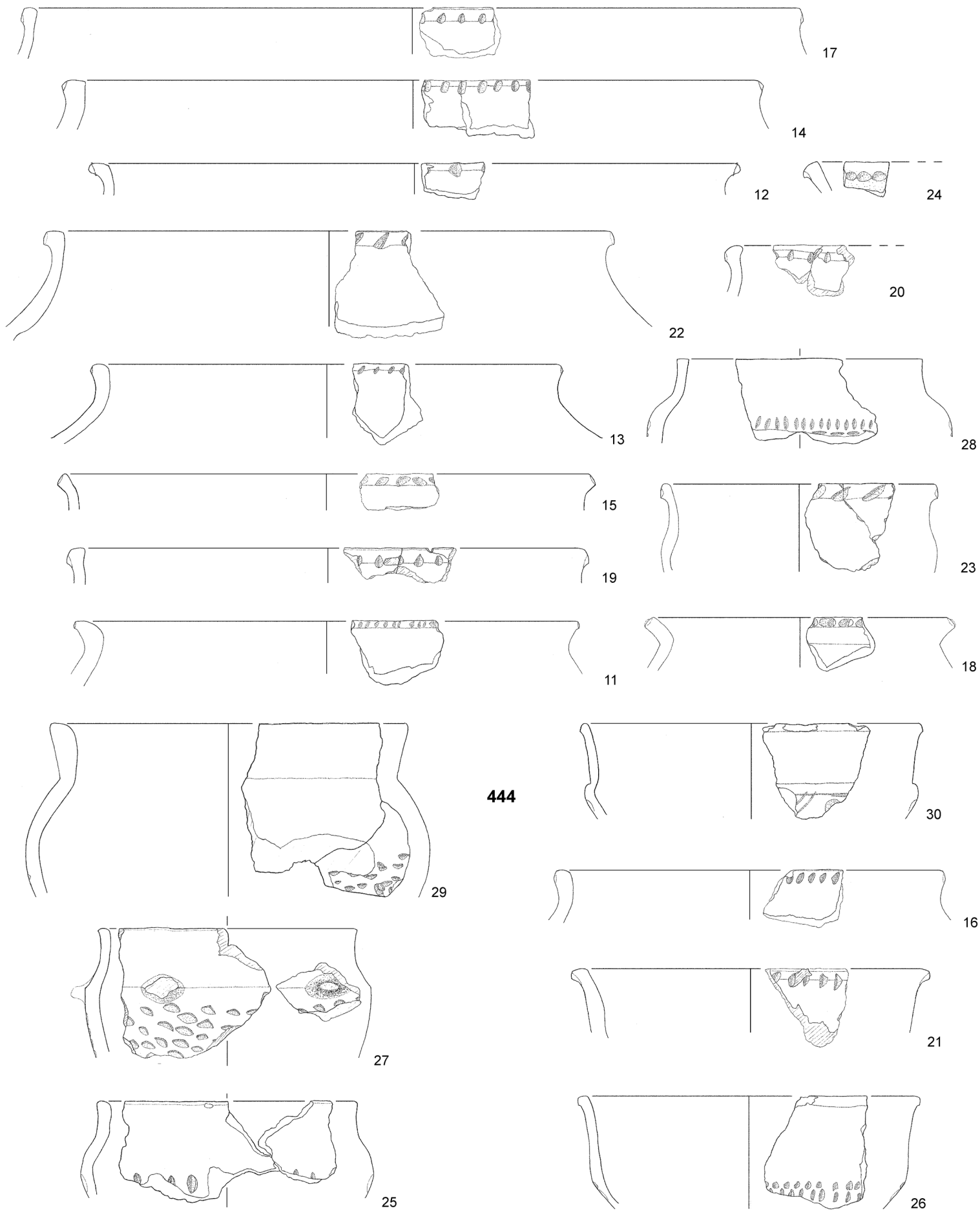

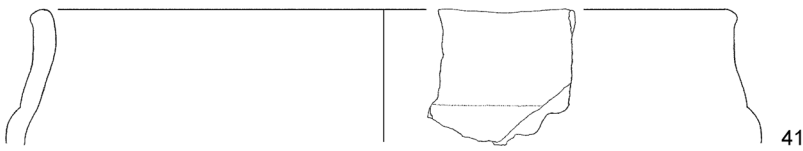
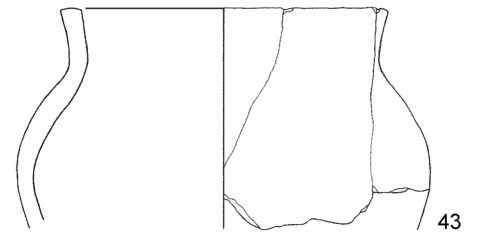
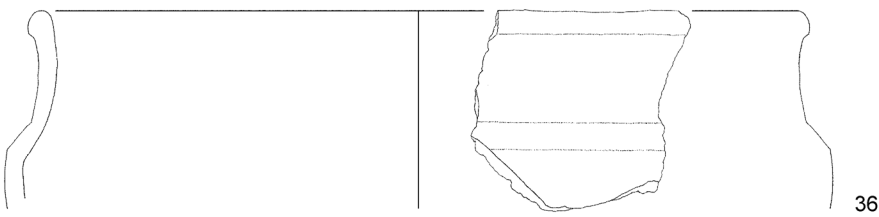
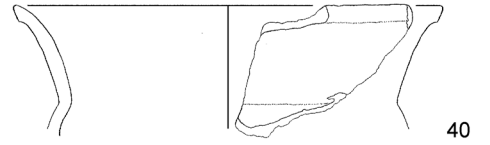
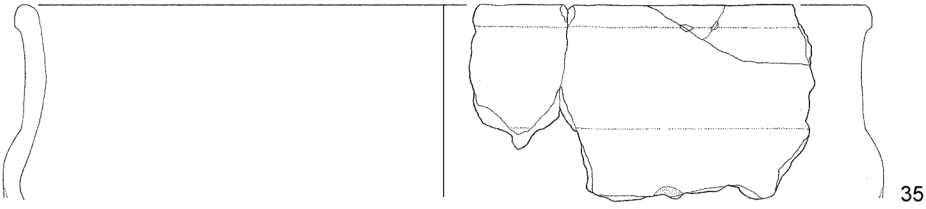
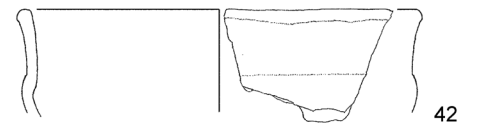
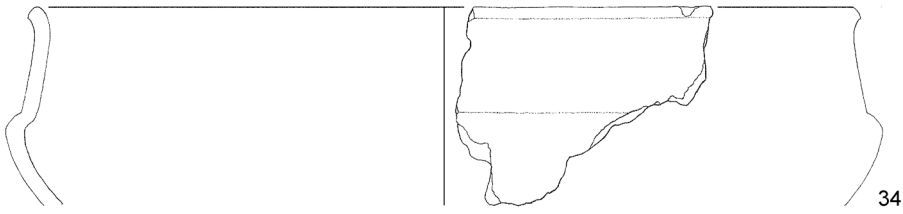

444

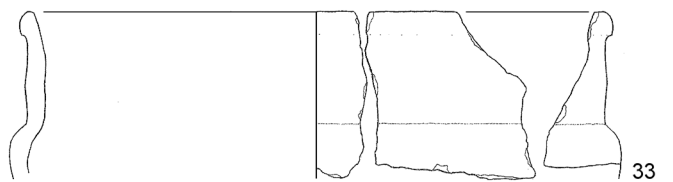
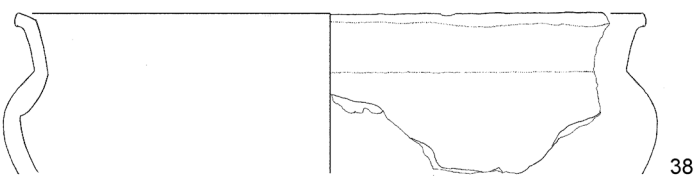
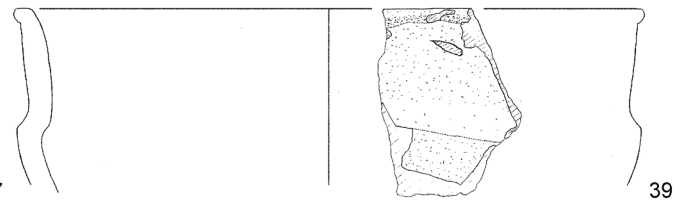
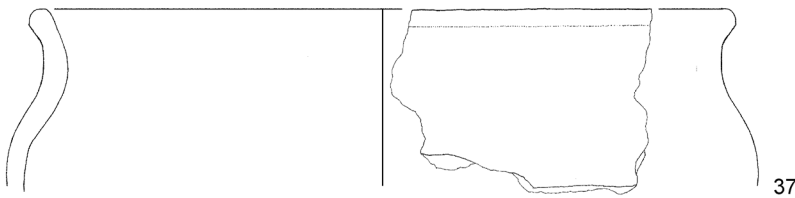
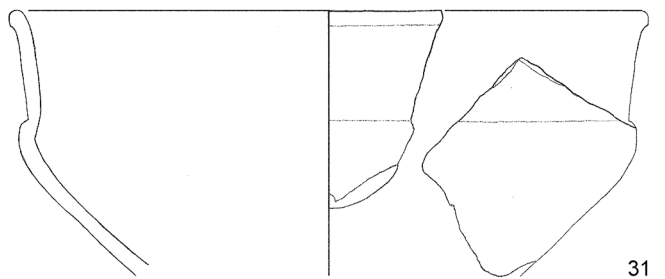
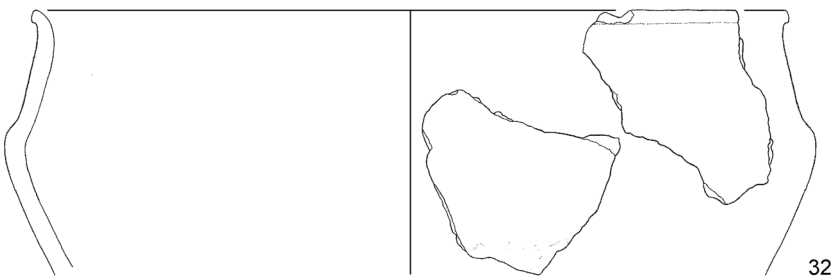
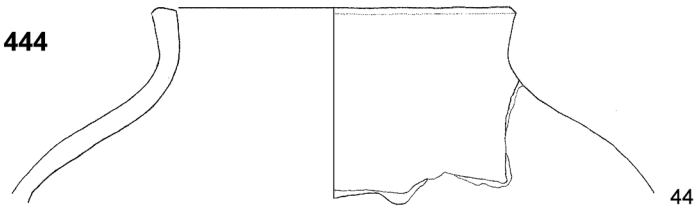

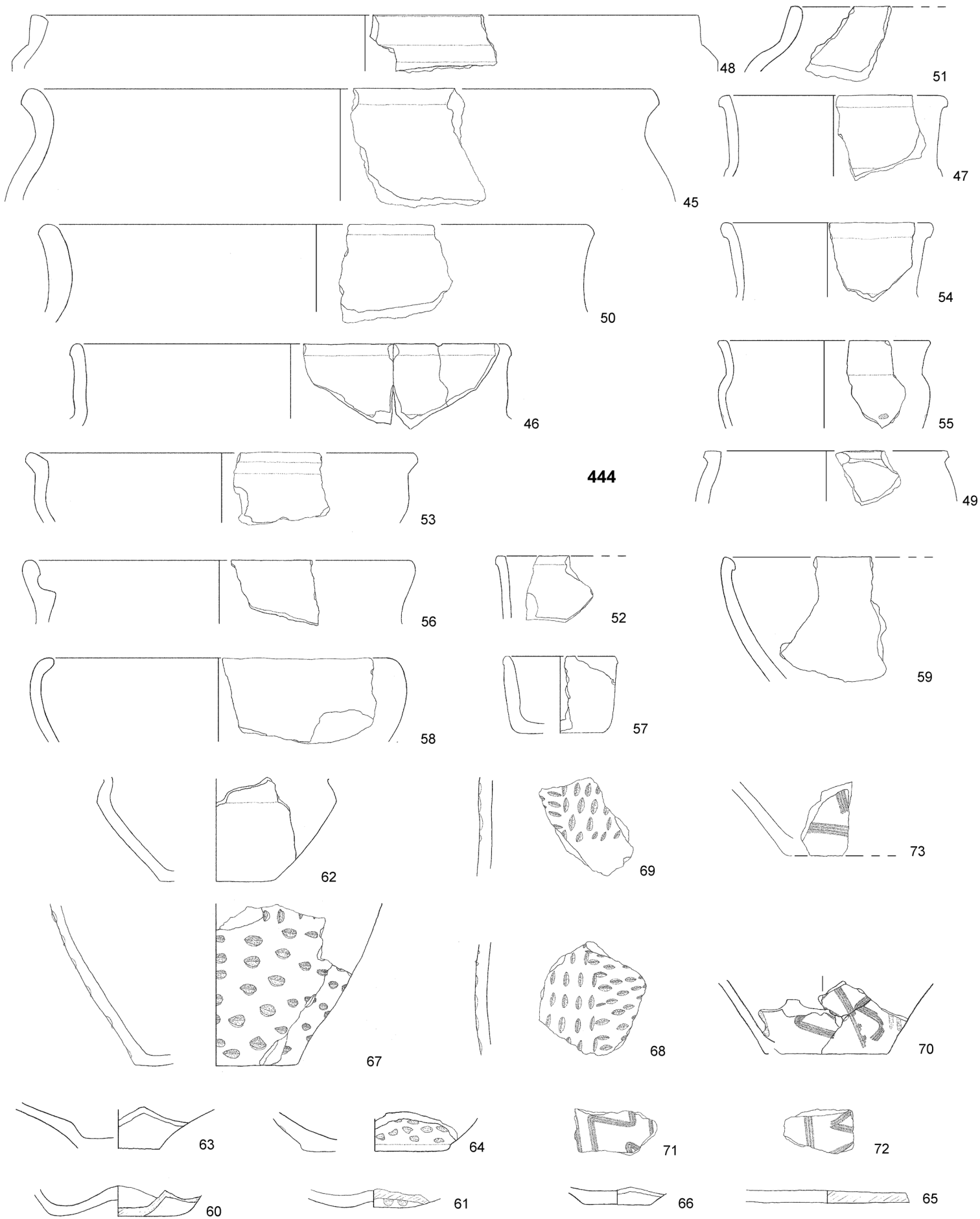

Enger-Ost, Befund 444 (F.-Nr. 45-73); M 1:3.

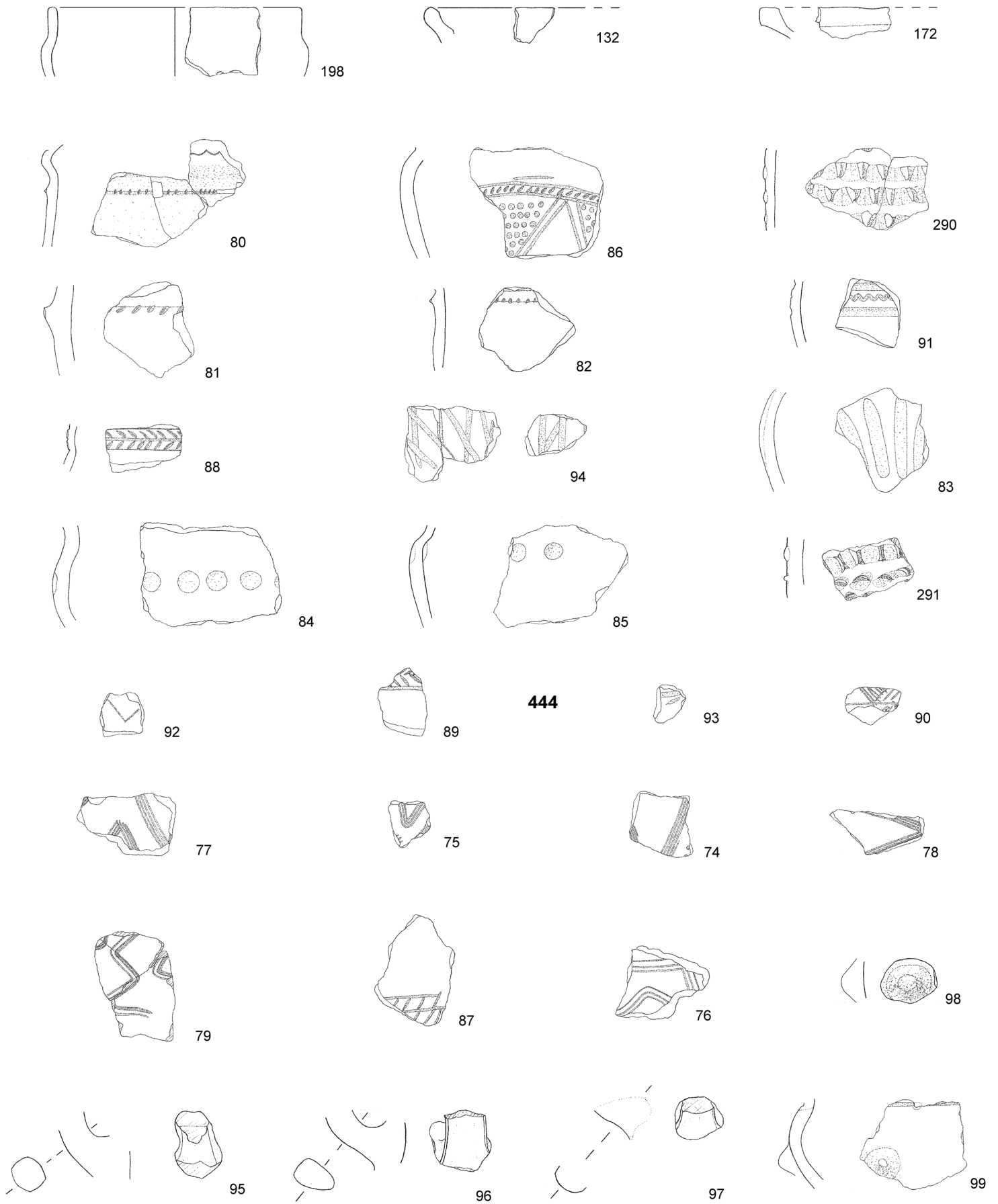

Enger-Ost, Befund 444 (F.-Nr. 74-291); M 1:3.

TAFEL 40

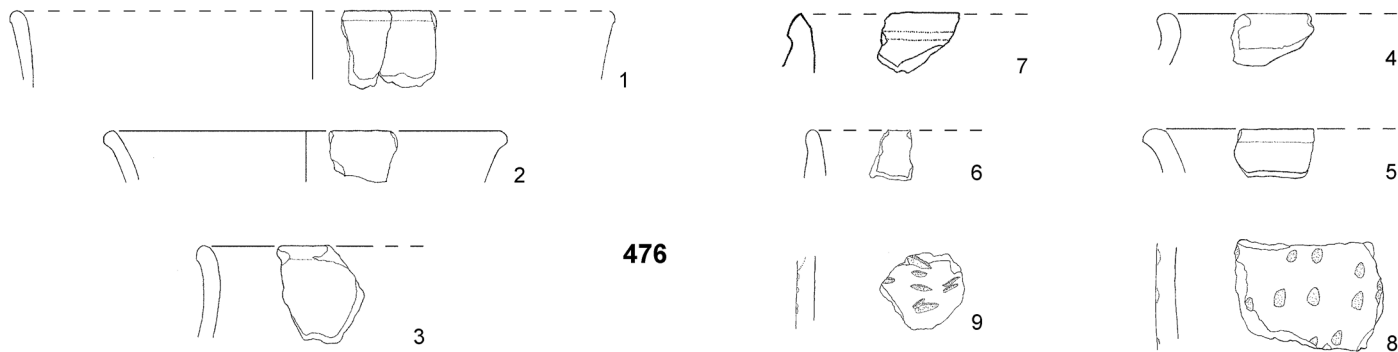

476

476a

476b

476c

476d

477

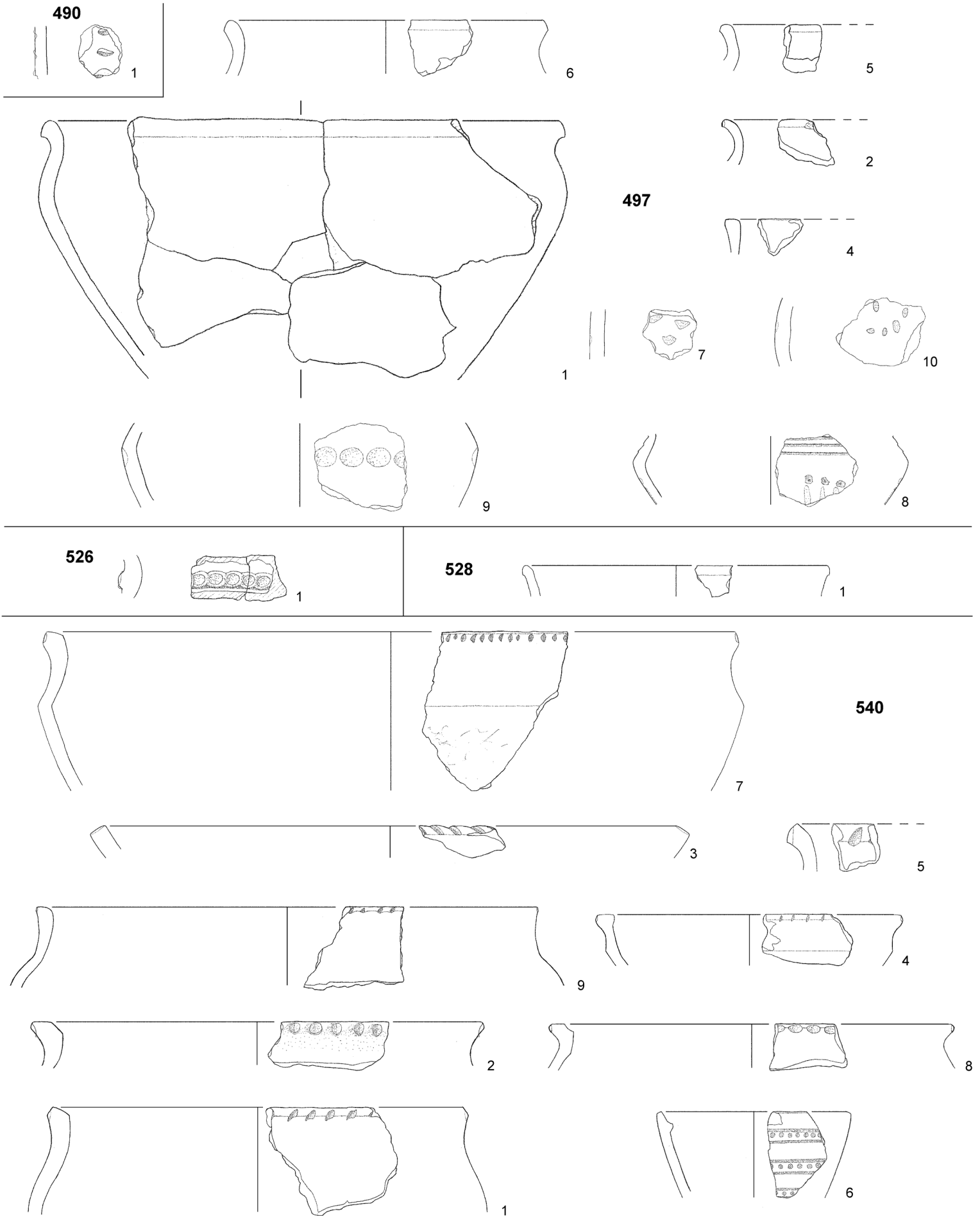

Enger-Ost, Befunde 490, 497, 526, 528 und 540 (F.-Nr. 1-9); M 1:3.

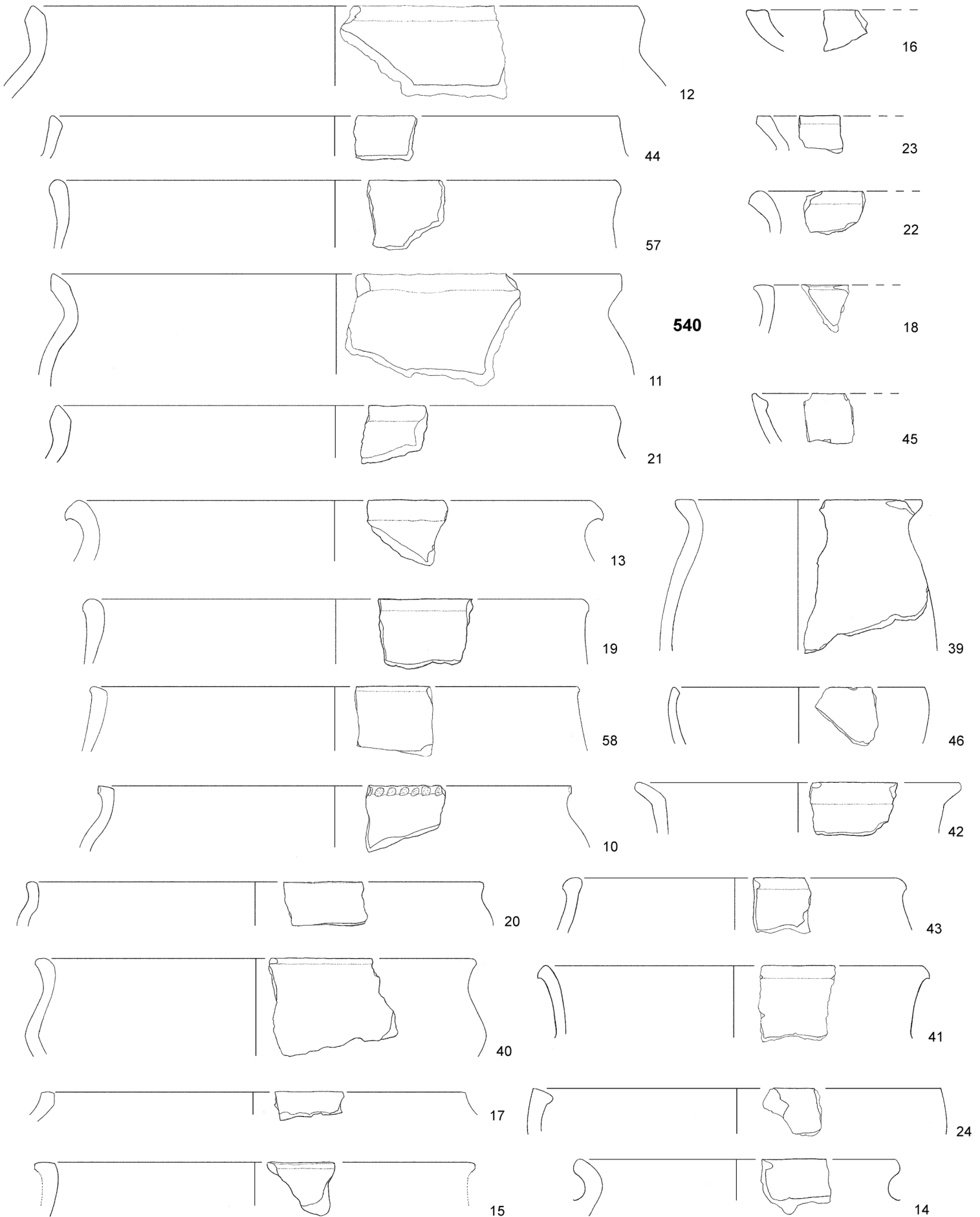

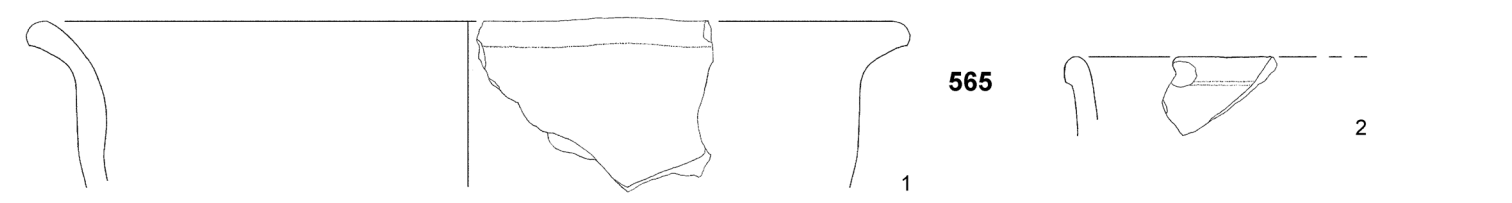
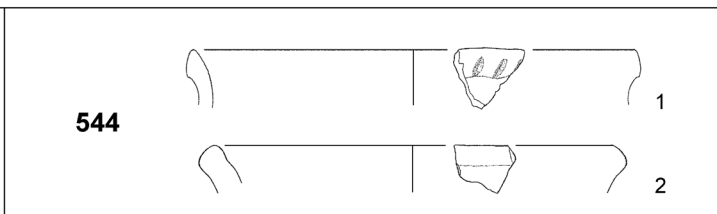
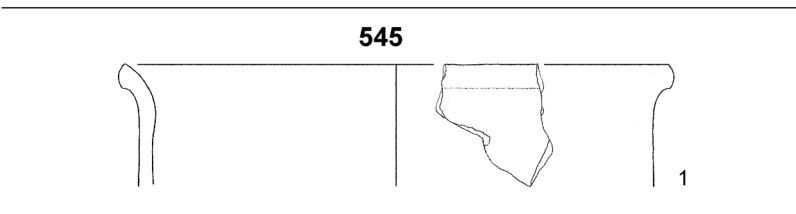
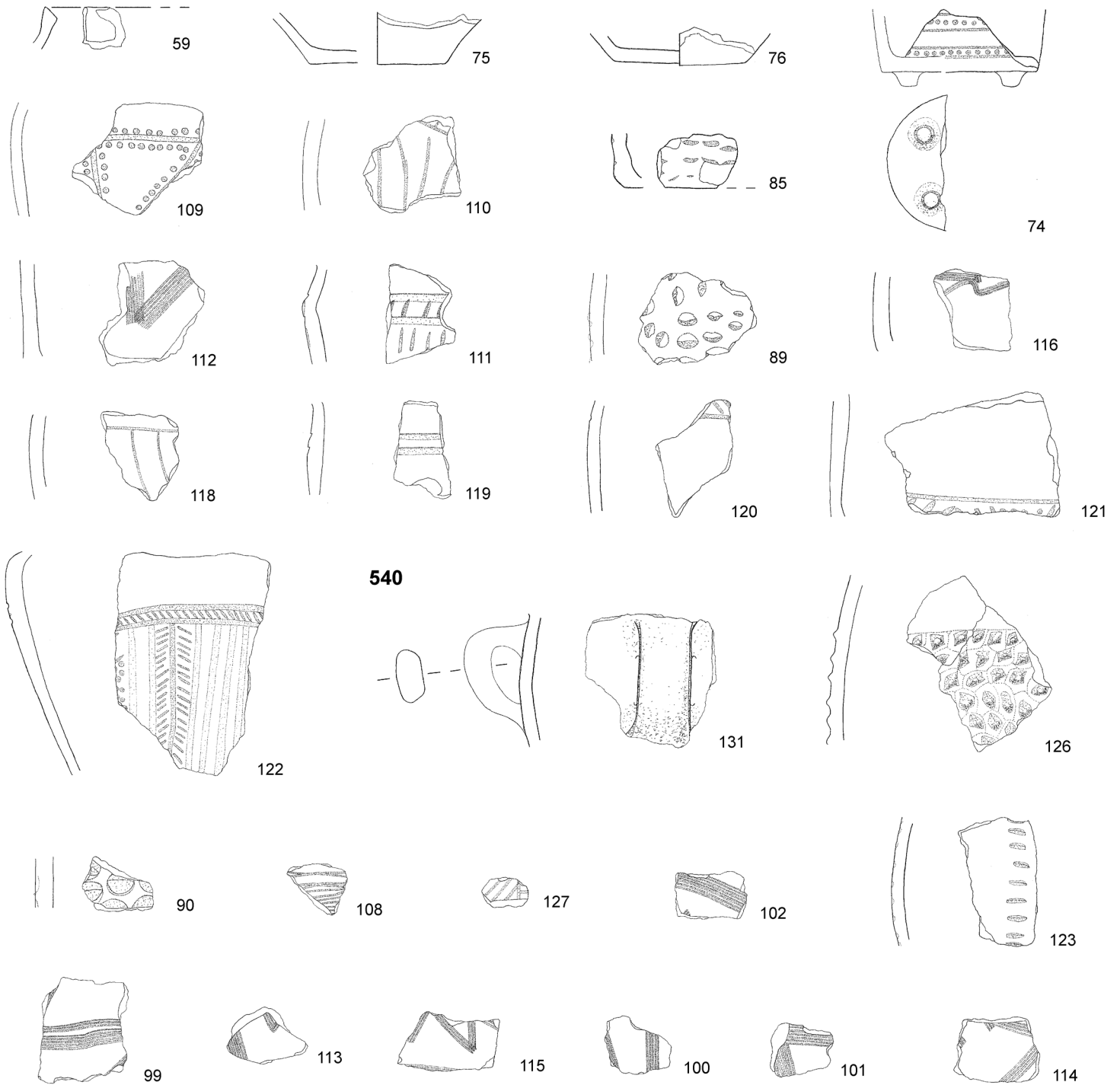

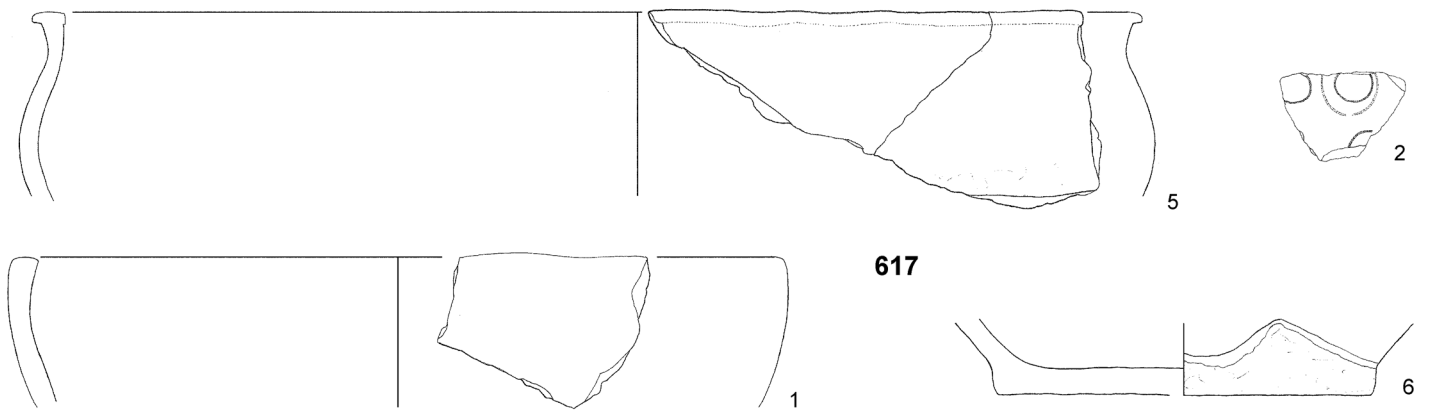
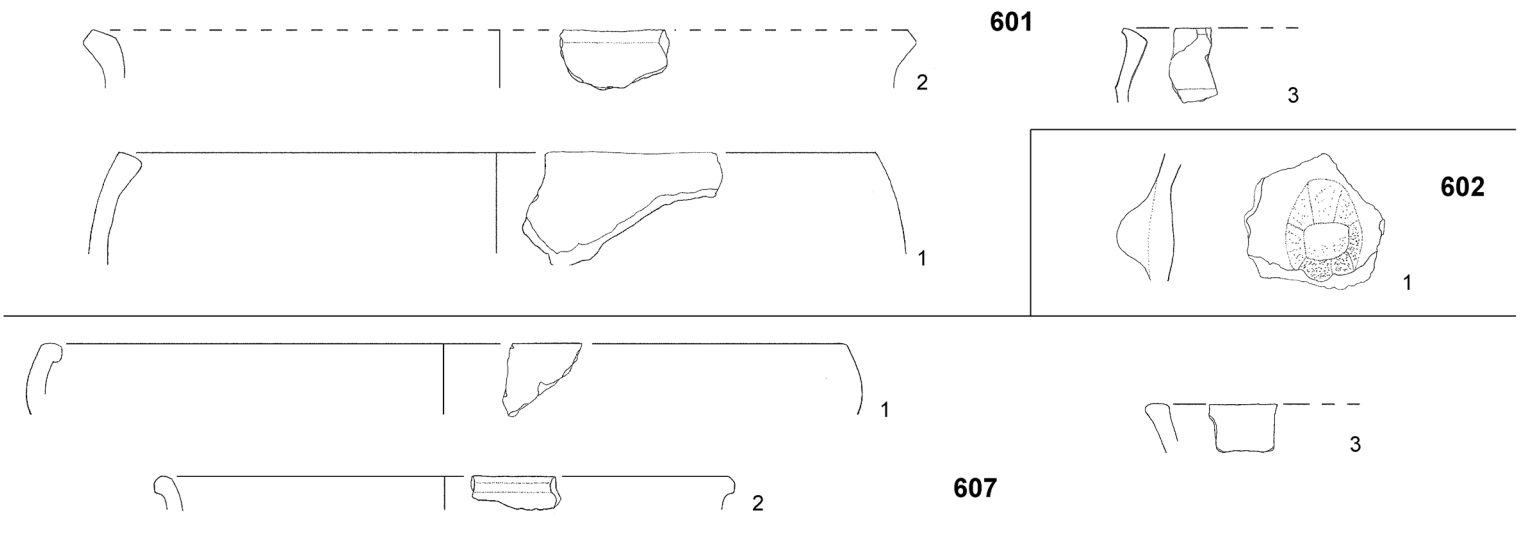
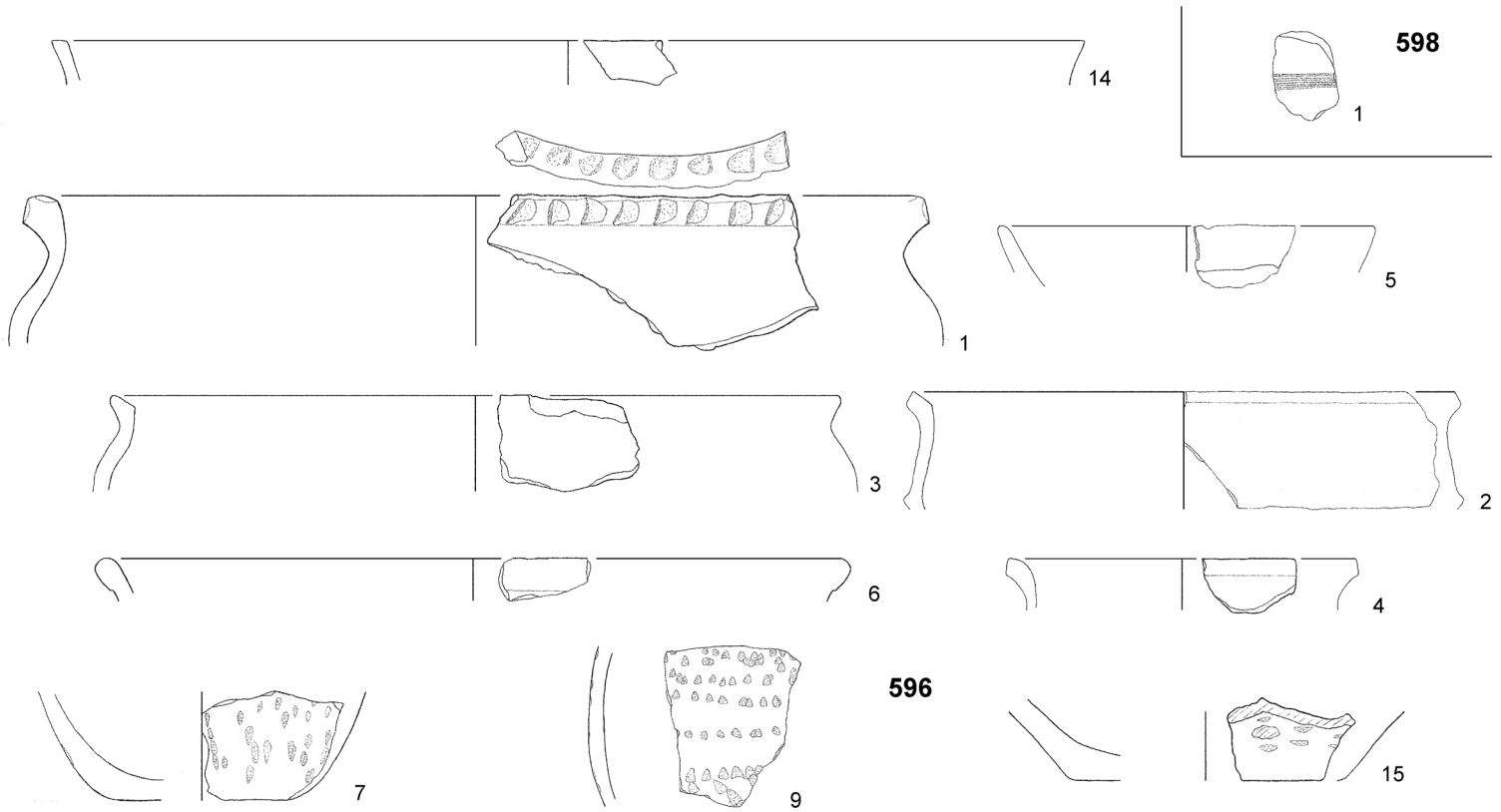

623



1

624



1

628



1



2



3



4



5



6

631



1

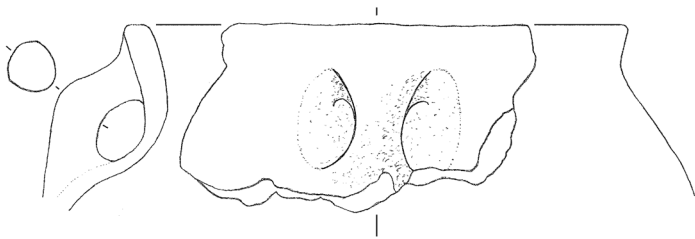

1

634



4



2



3



6



5

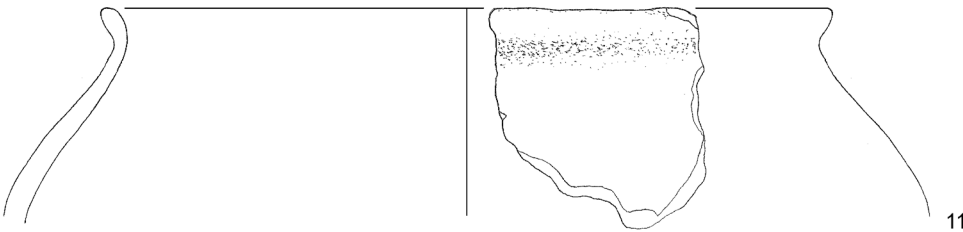

11

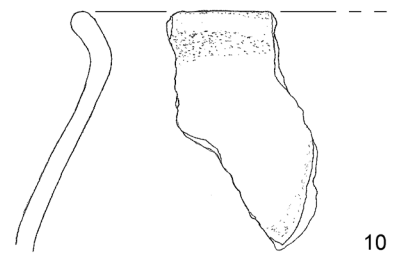

10

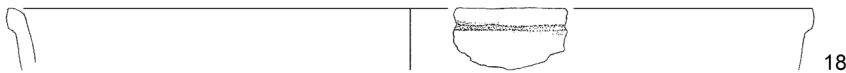

18



17

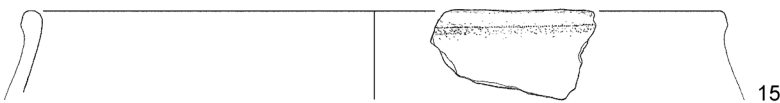

15

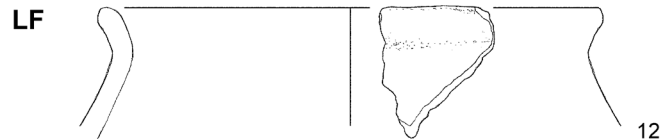

12

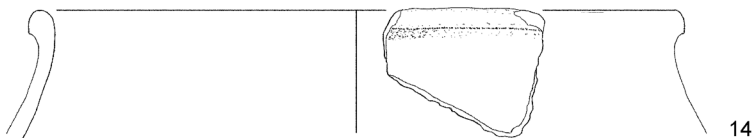

14

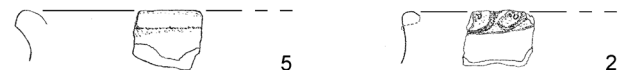

5

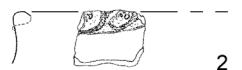

2

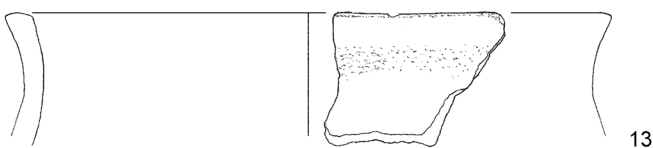

13



4



6

LF

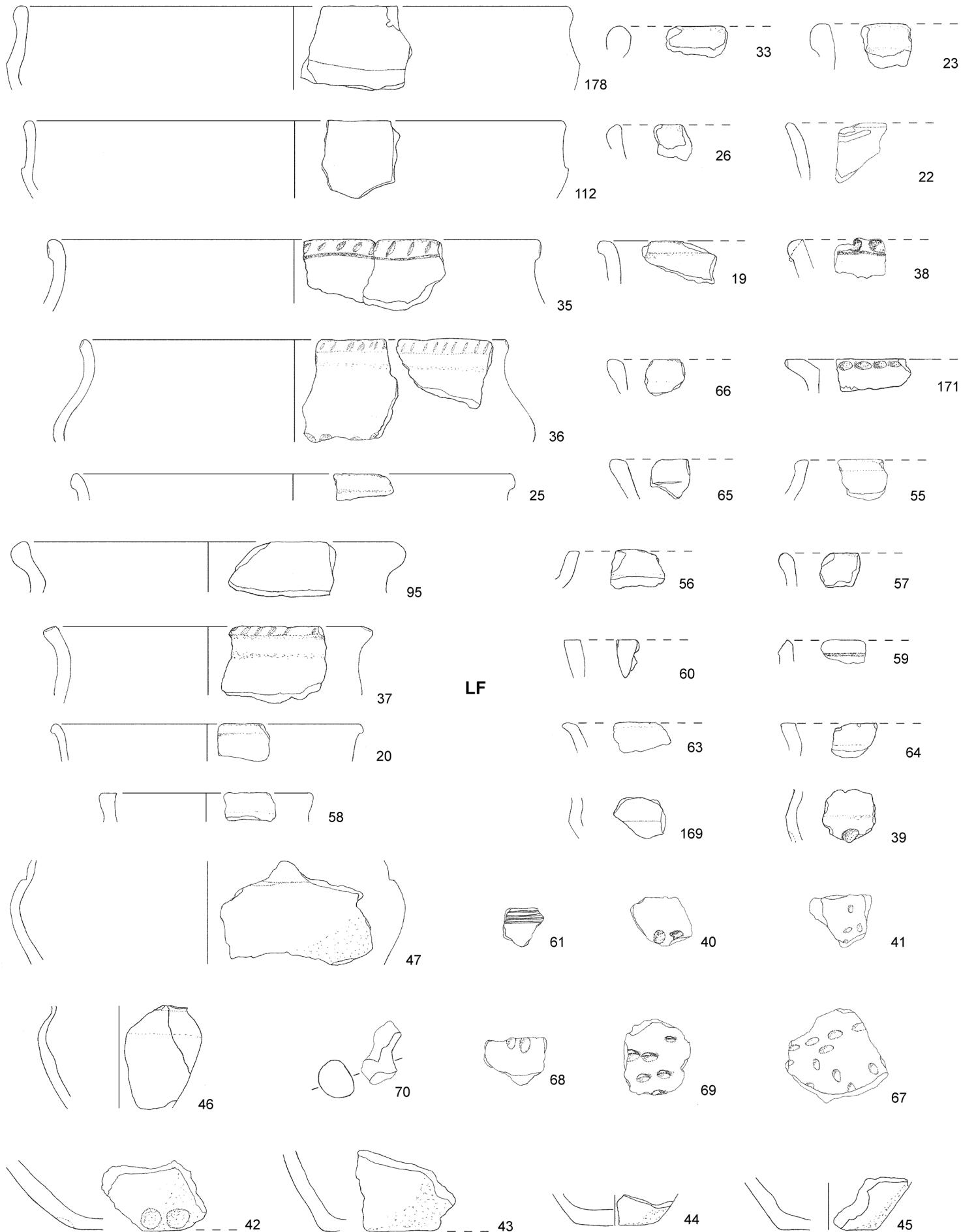

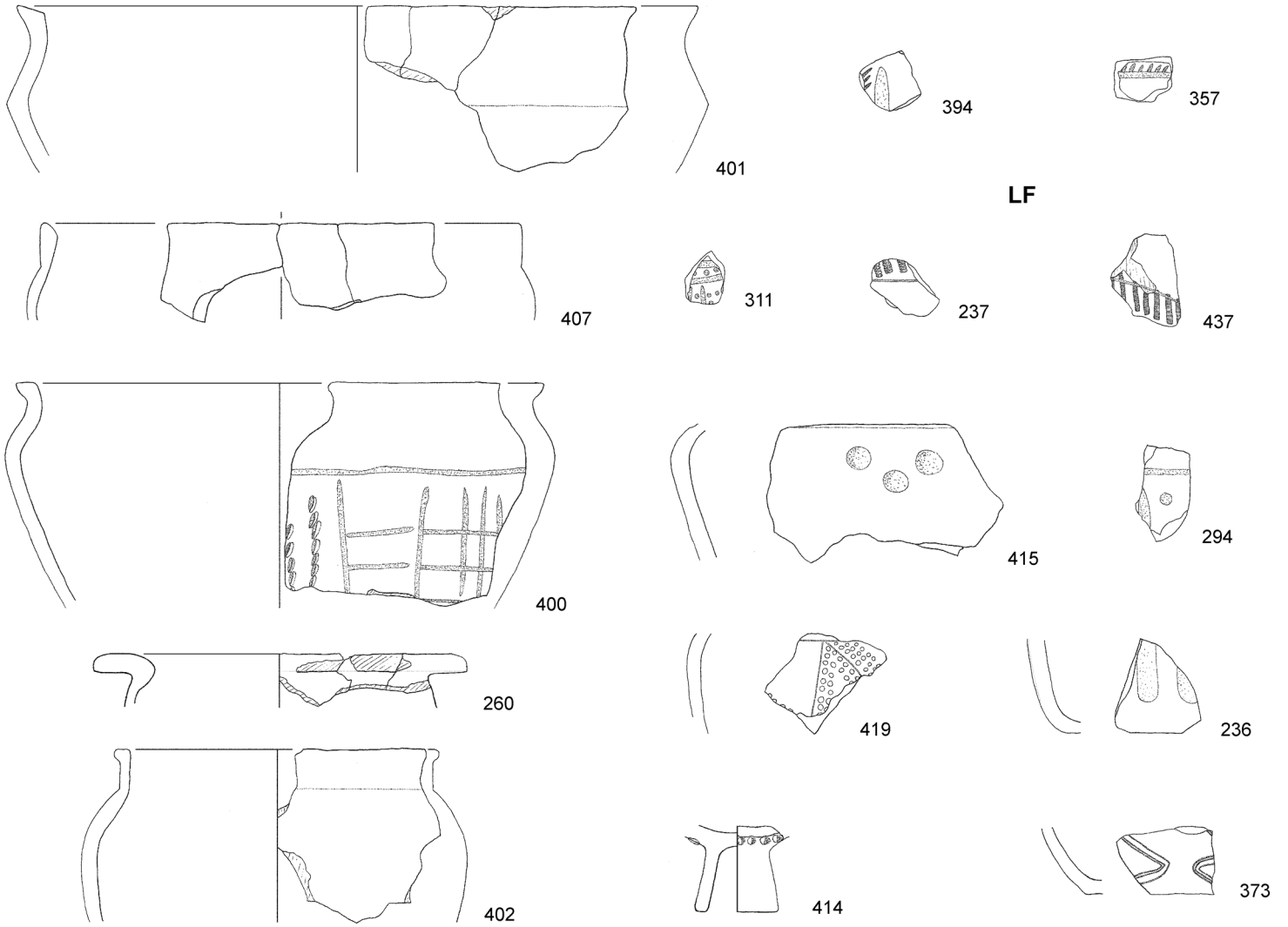

G2

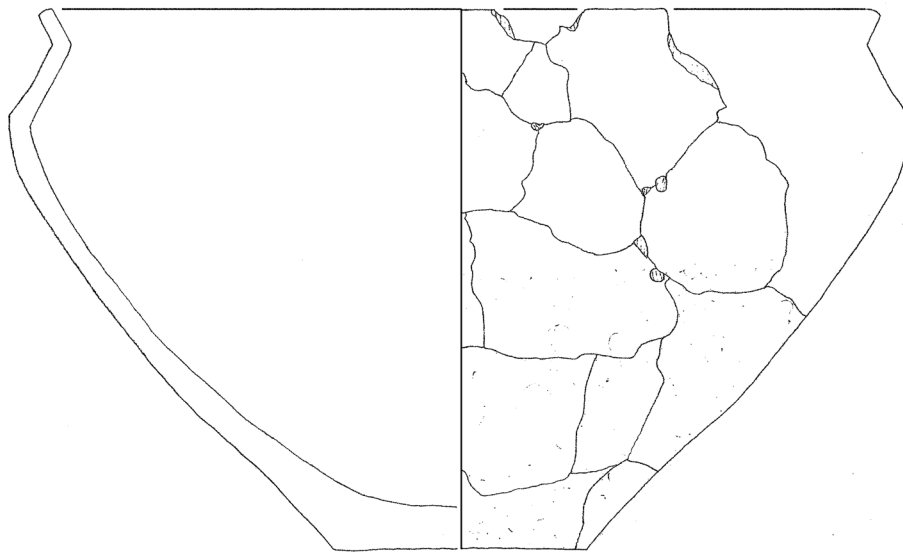

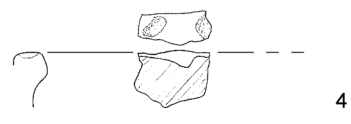
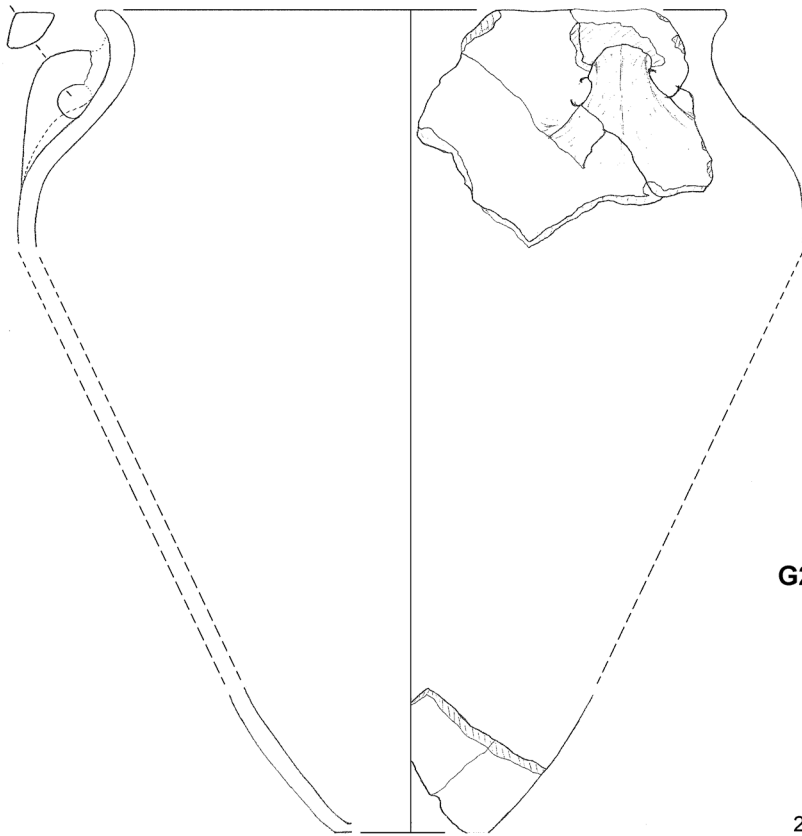

G2

2

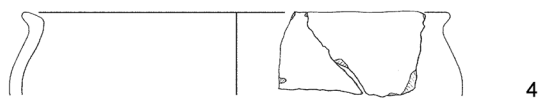
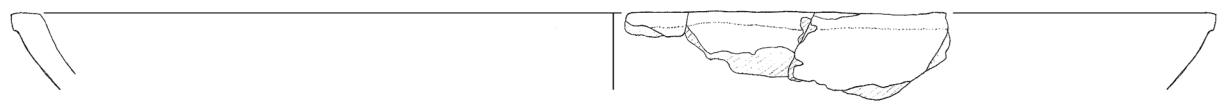

G3

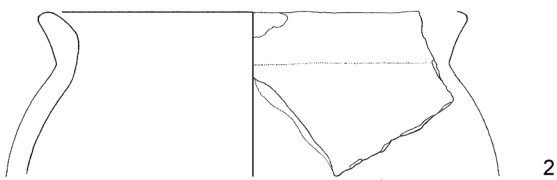
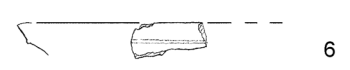
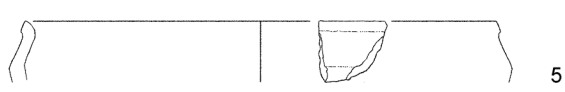

G6



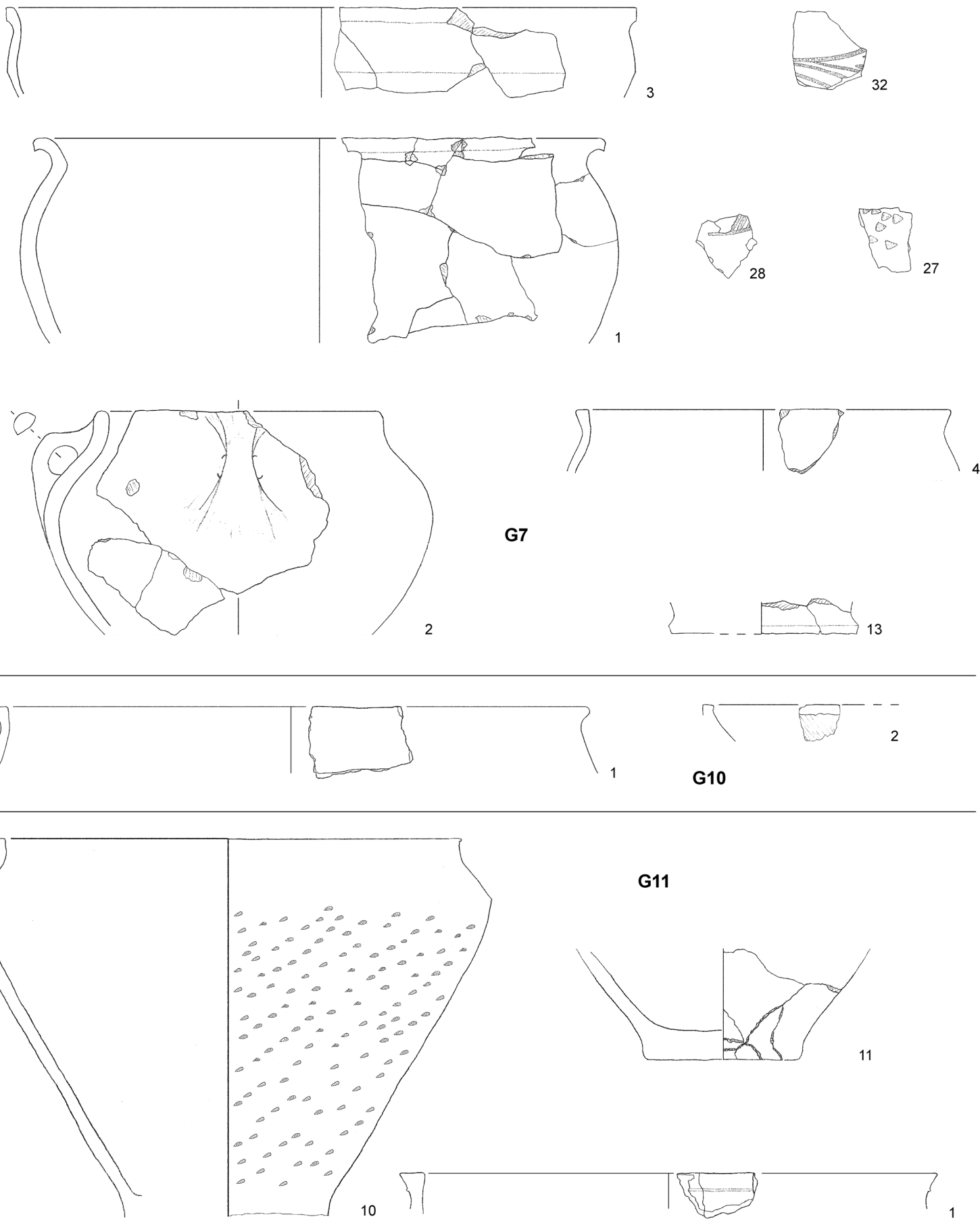

Enger-West, Befunde G7, G10 und G11; M 1:3.

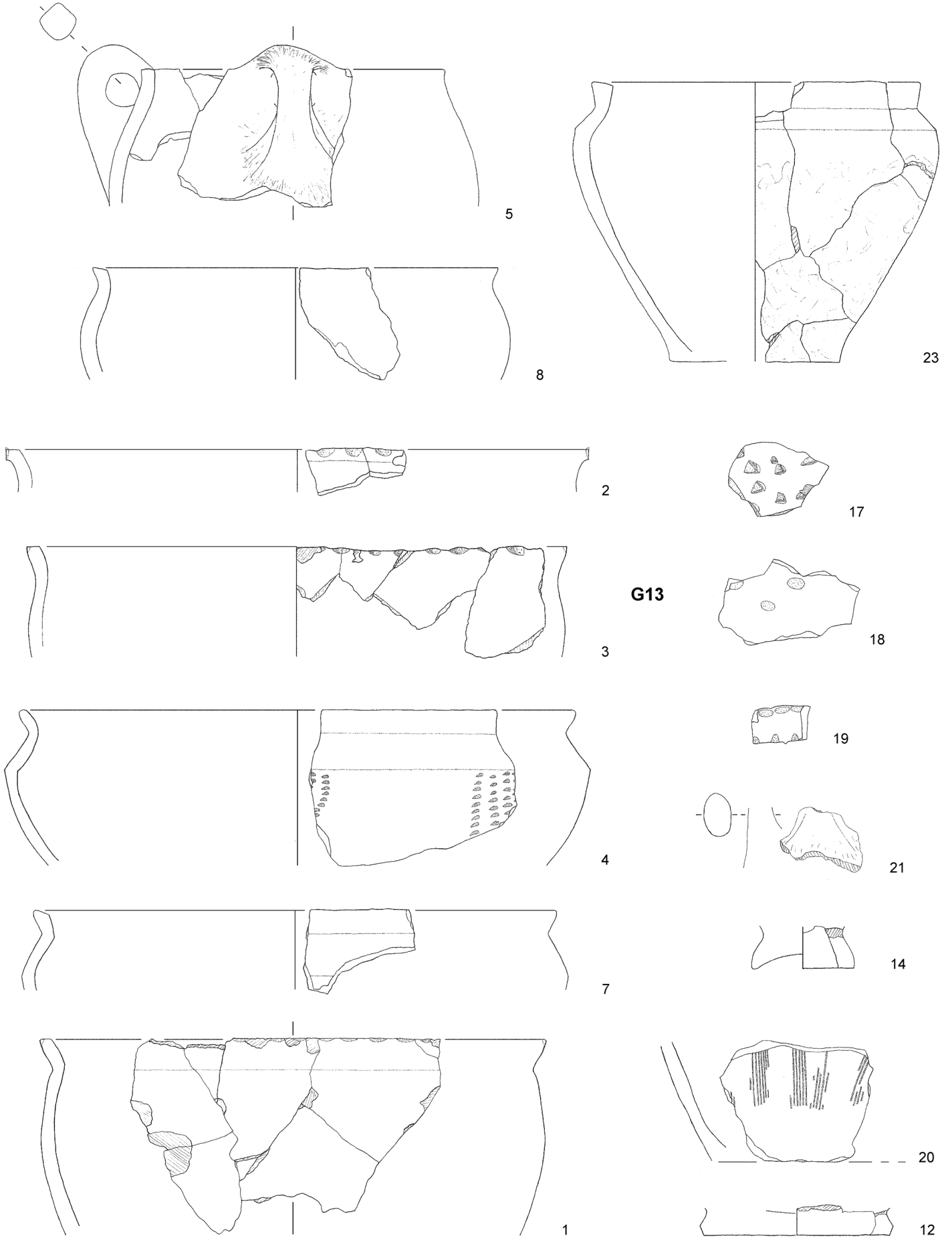

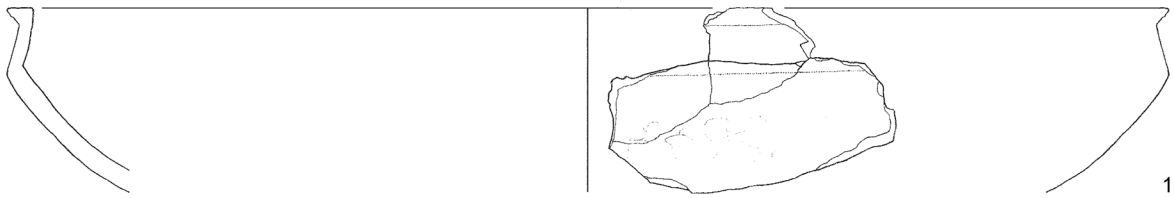

G14

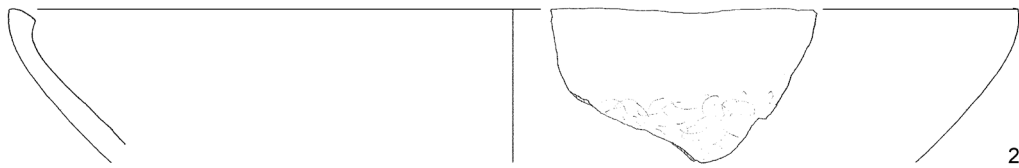
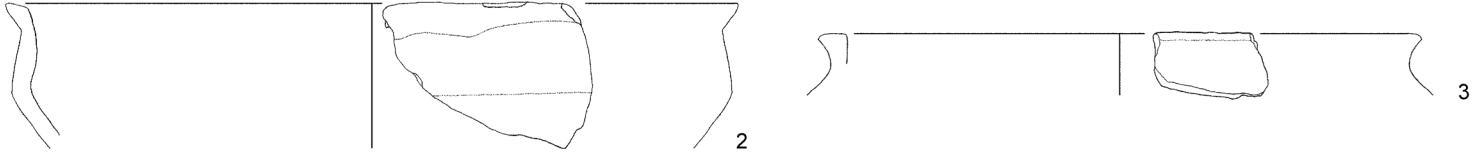

G15

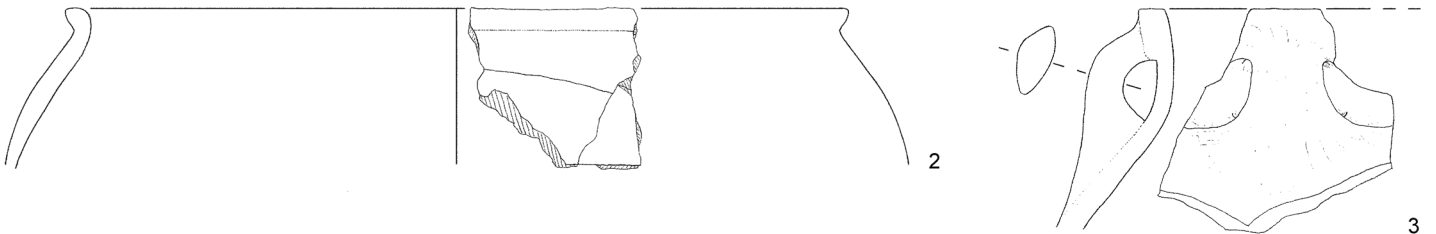

G16

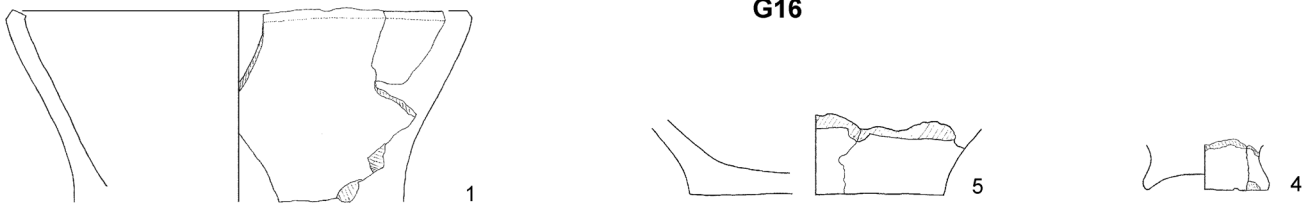

G17

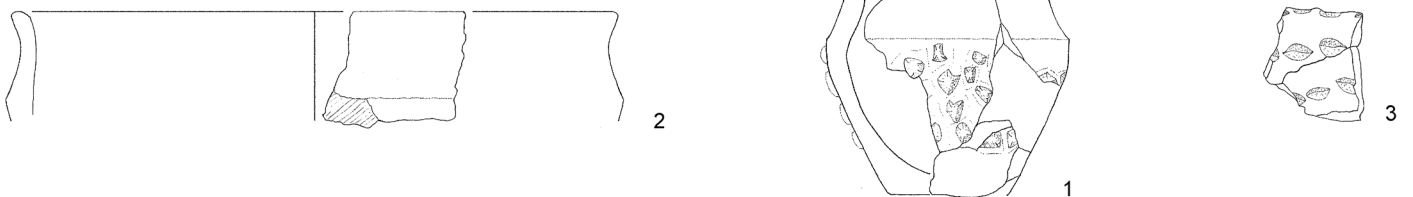

Enger-West, Befunde G14, G15, G16 und G17; M 1:3.

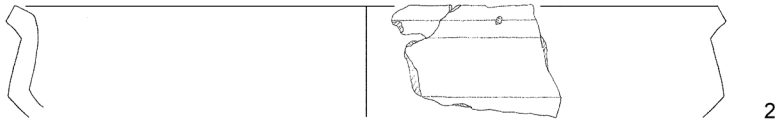
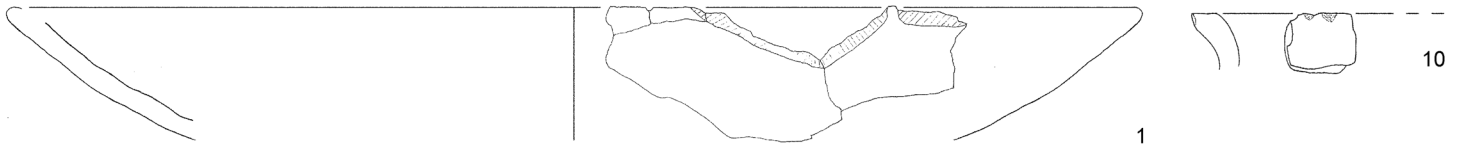

G18

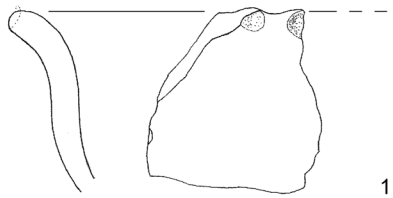
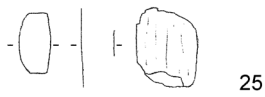
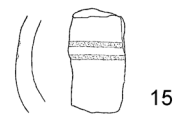
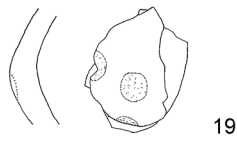
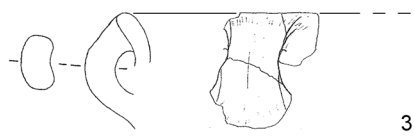

G22

G20



G23

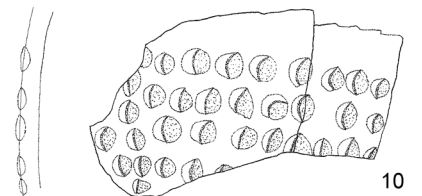
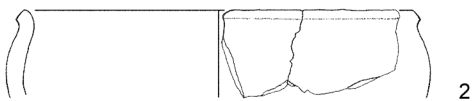

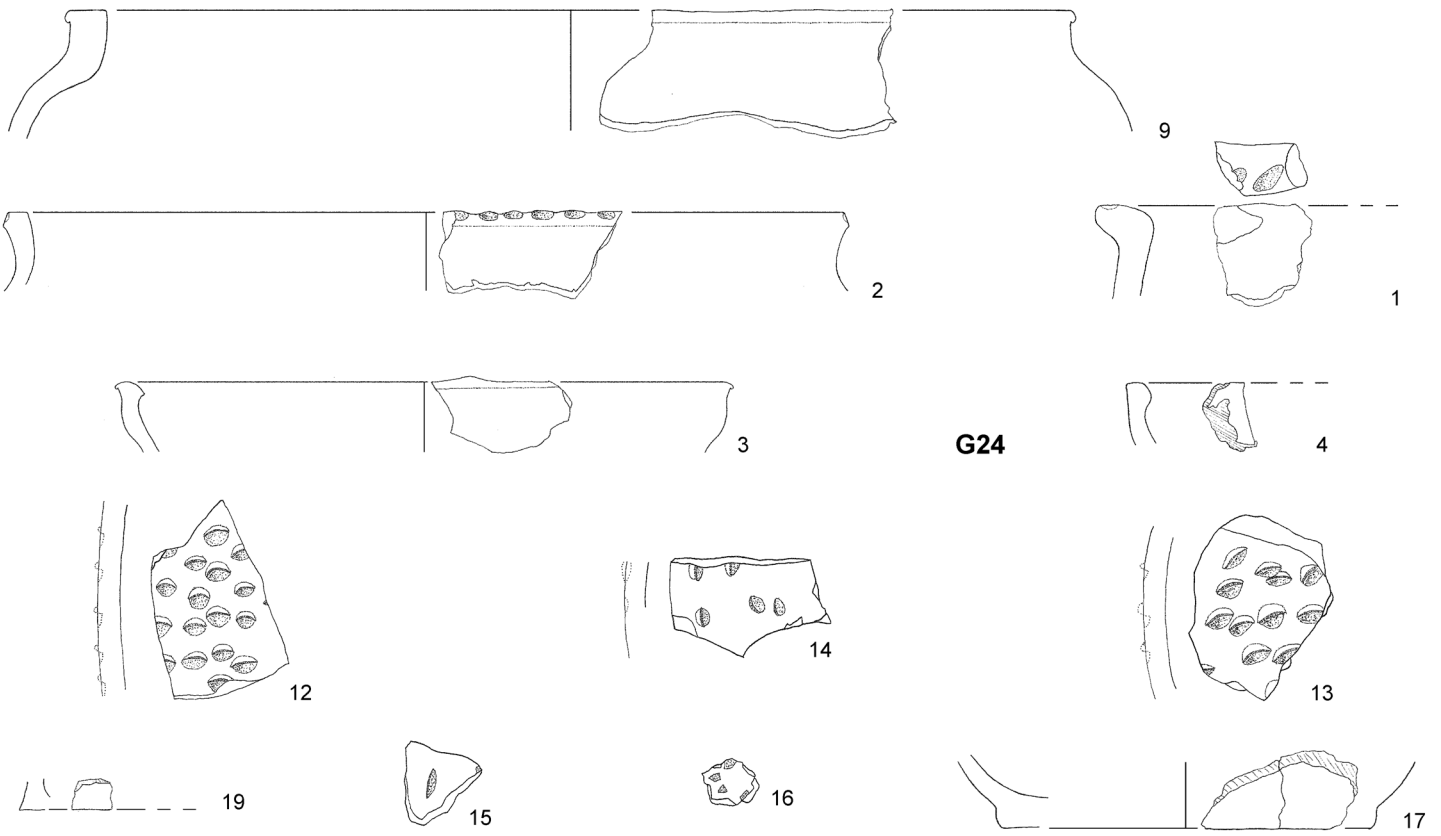

G24

G25

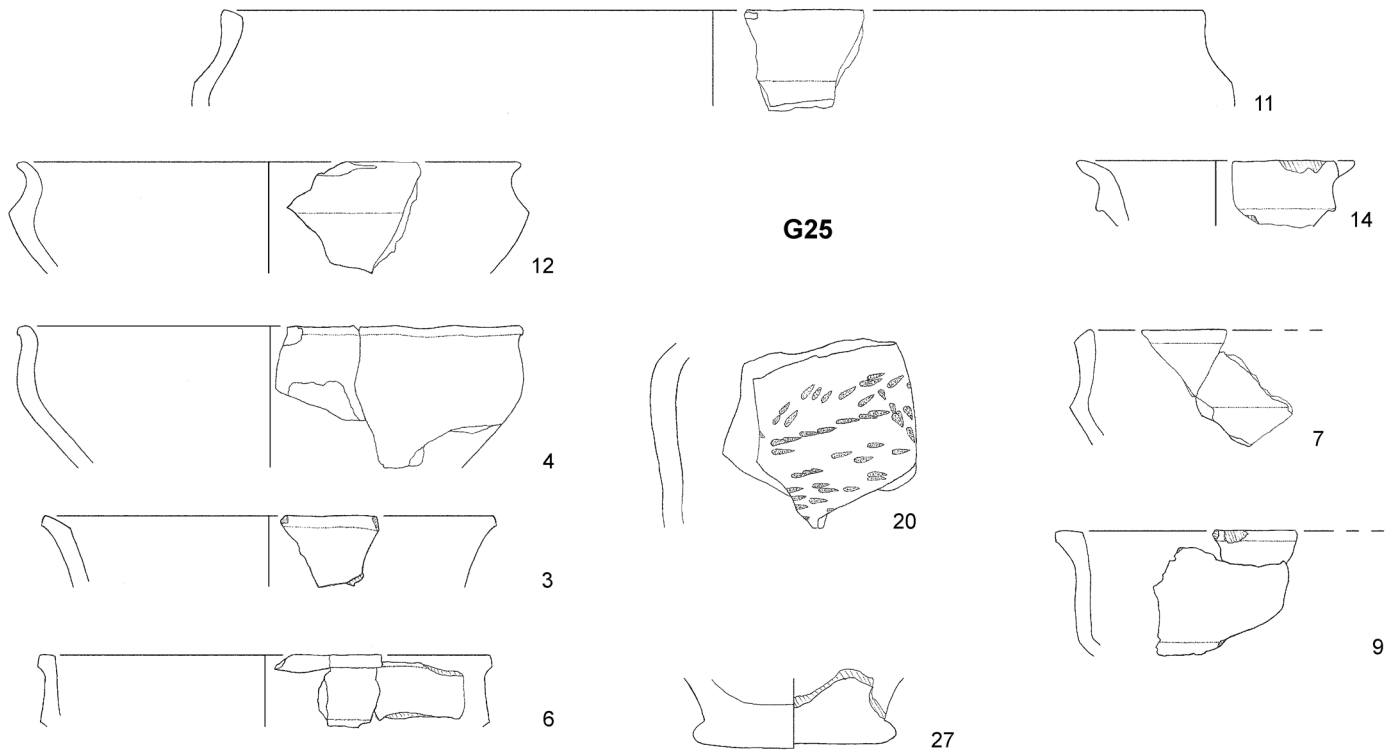
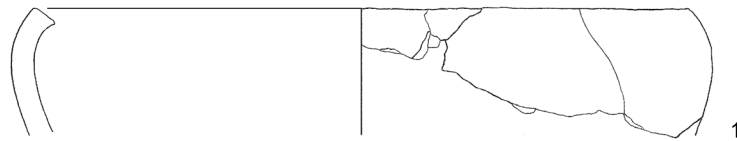

G25

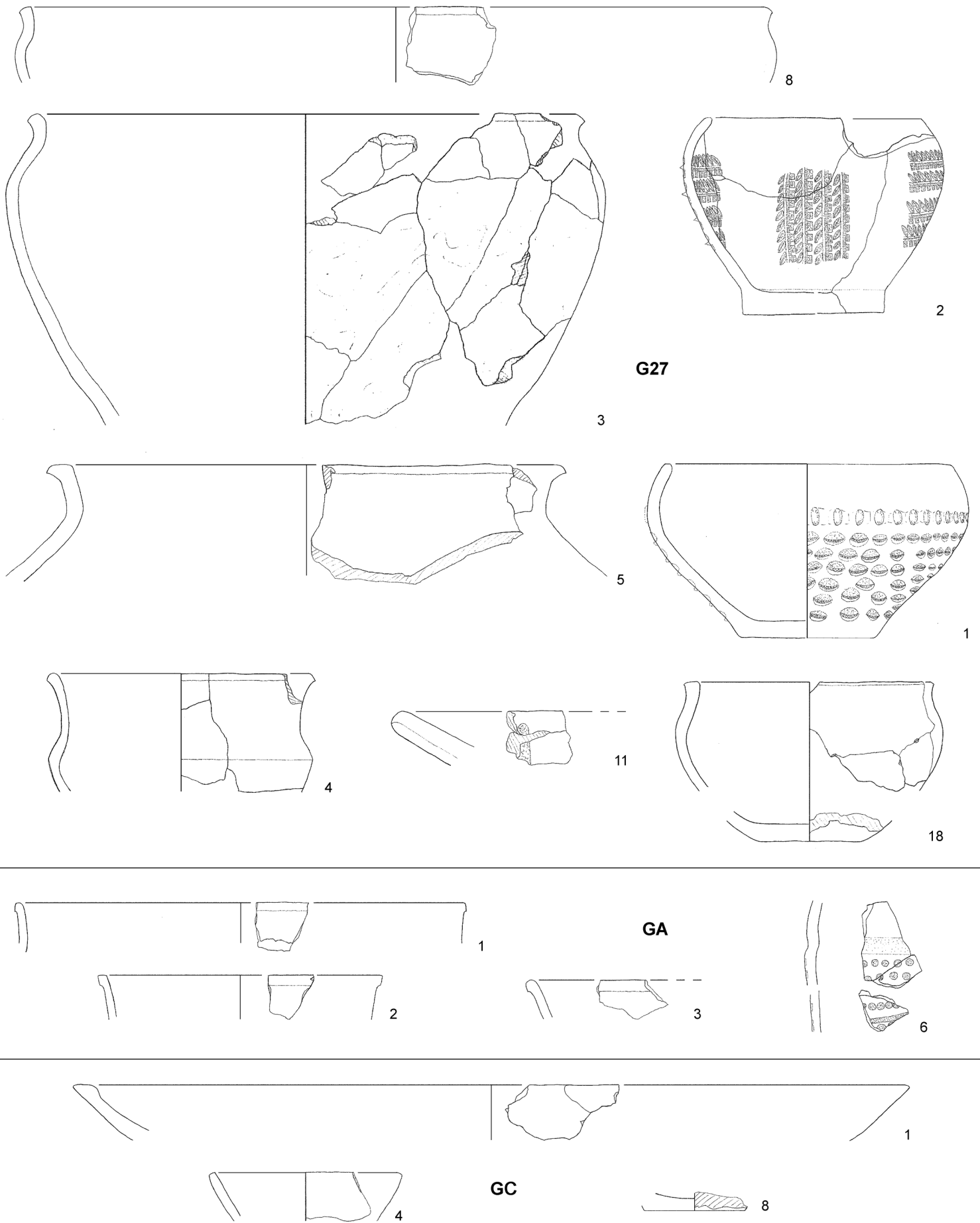

Enger-West, Befunde G27, GA und GC; M 1:3.

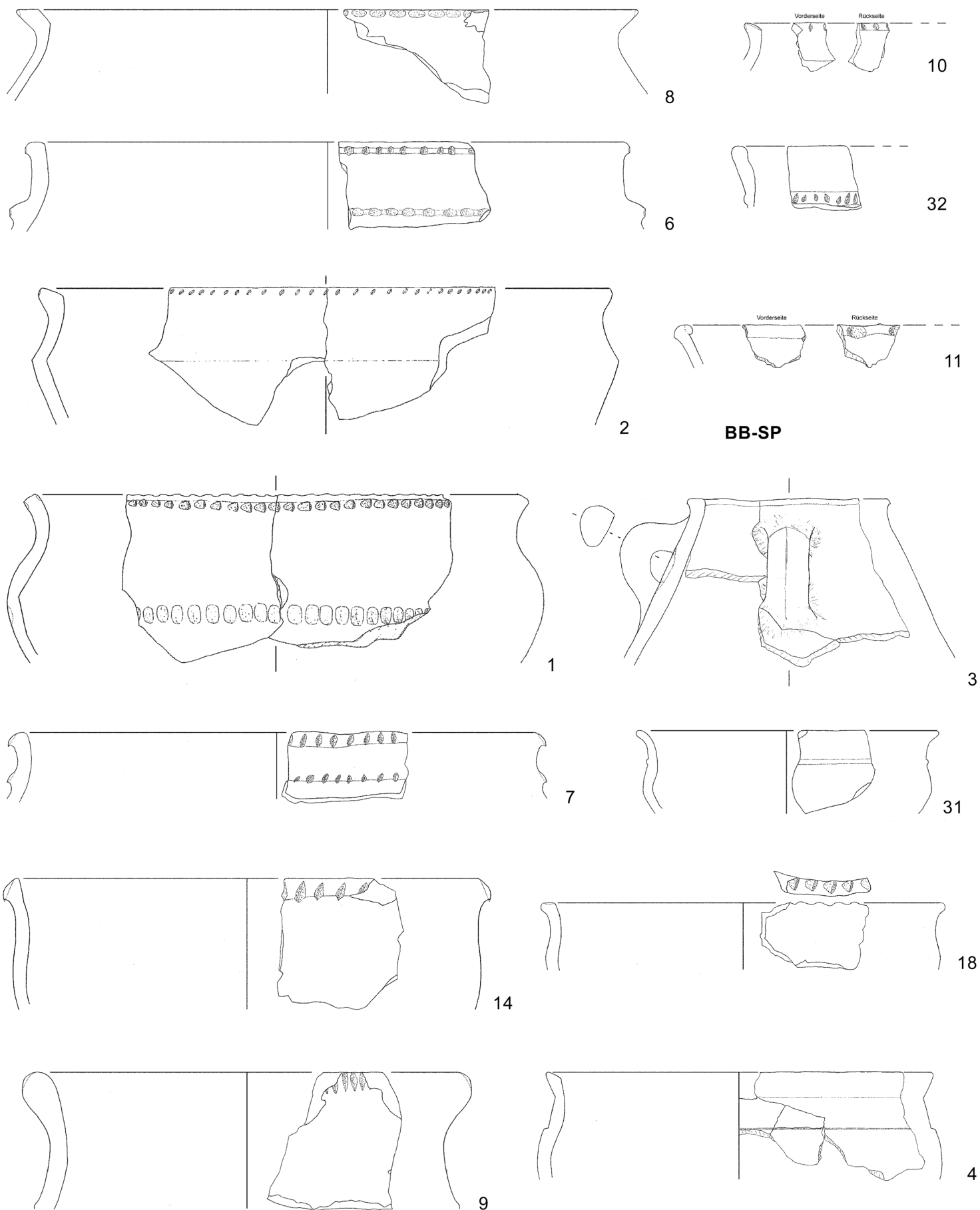

Enger-Bachbett, Stichprobe (F.-Nr. 1-32); M 1:3.

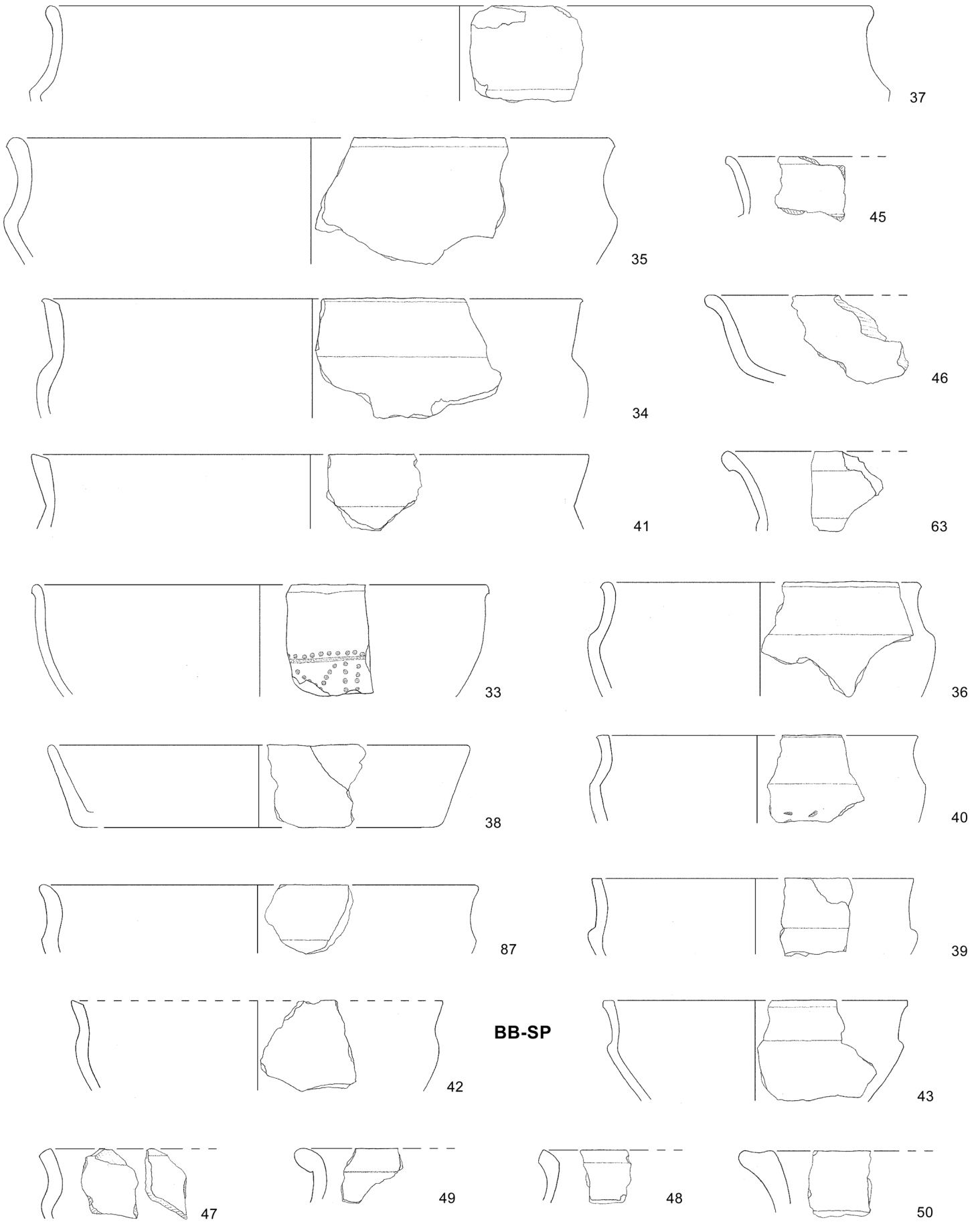

Enger-Bachbett, Stichprobe (F.-Nr. 33-87); M 1:3.

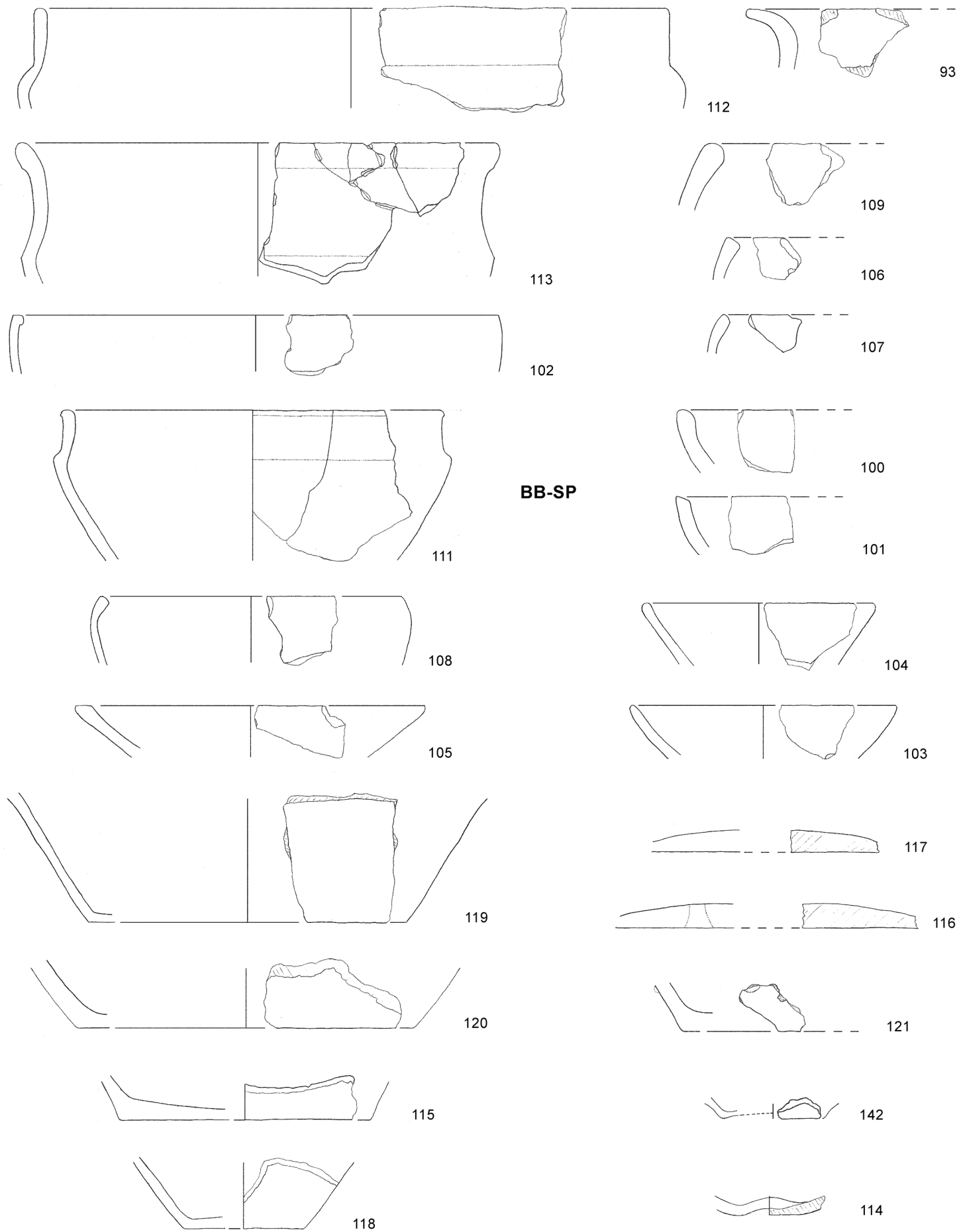

Enger-Bachbett, Stichprobe (F.-Nr. 93-142); M 1:3.

TABELLE 58

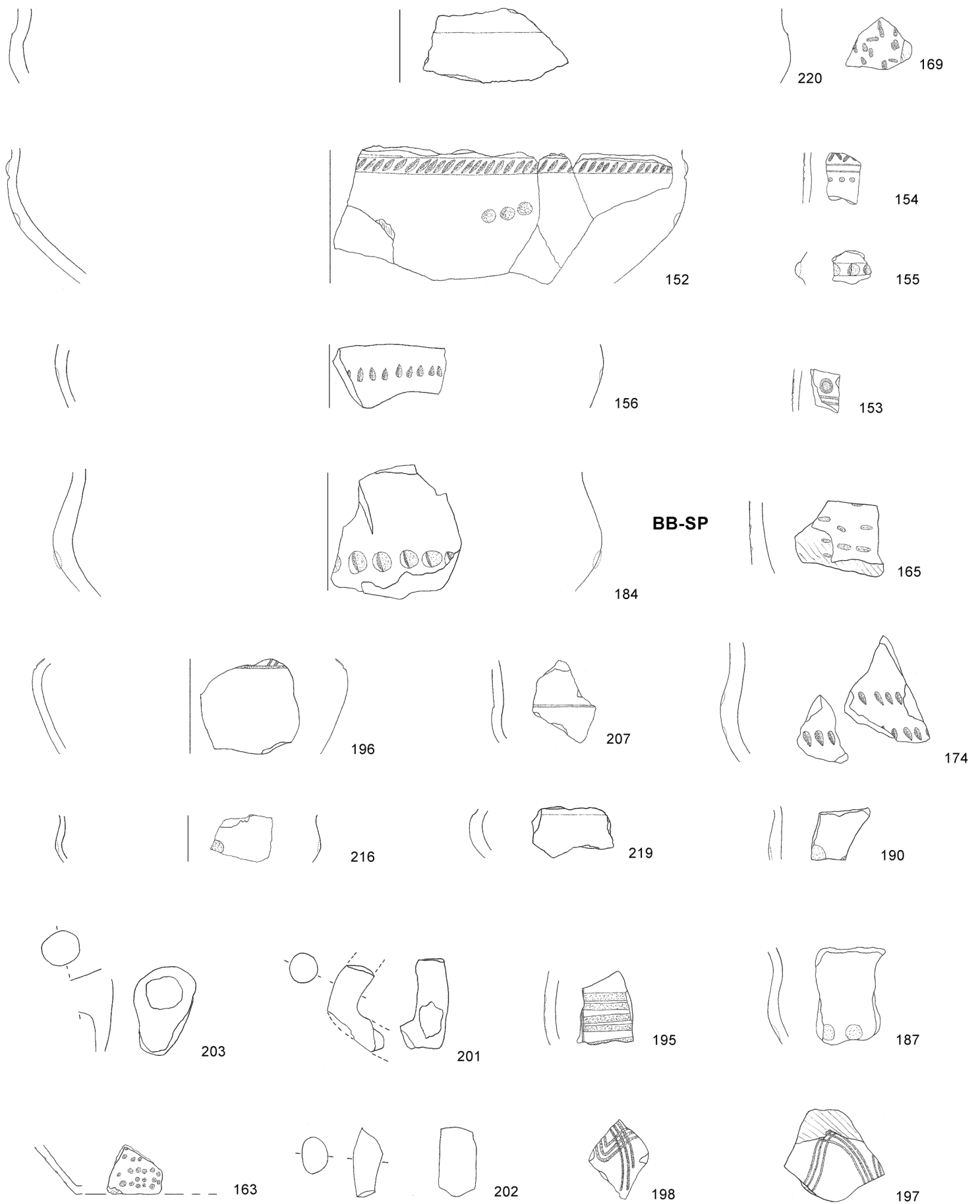

Enger-Bachbett, Stichprobe (F.-Nr. 152-220); M 1:3.

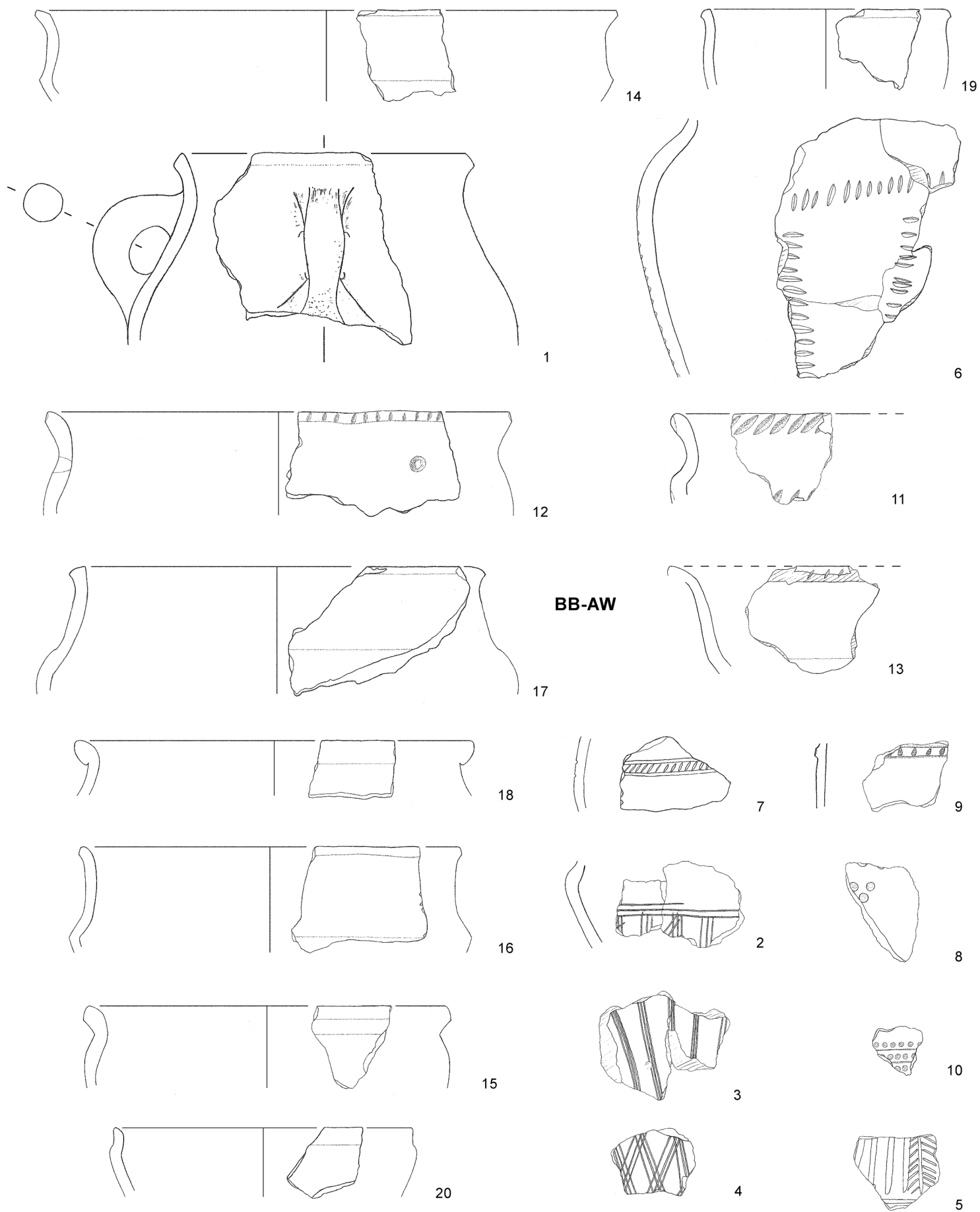

Enger-Bachbett, Auswahl (F.-Nr. 1-20); M 1:3.

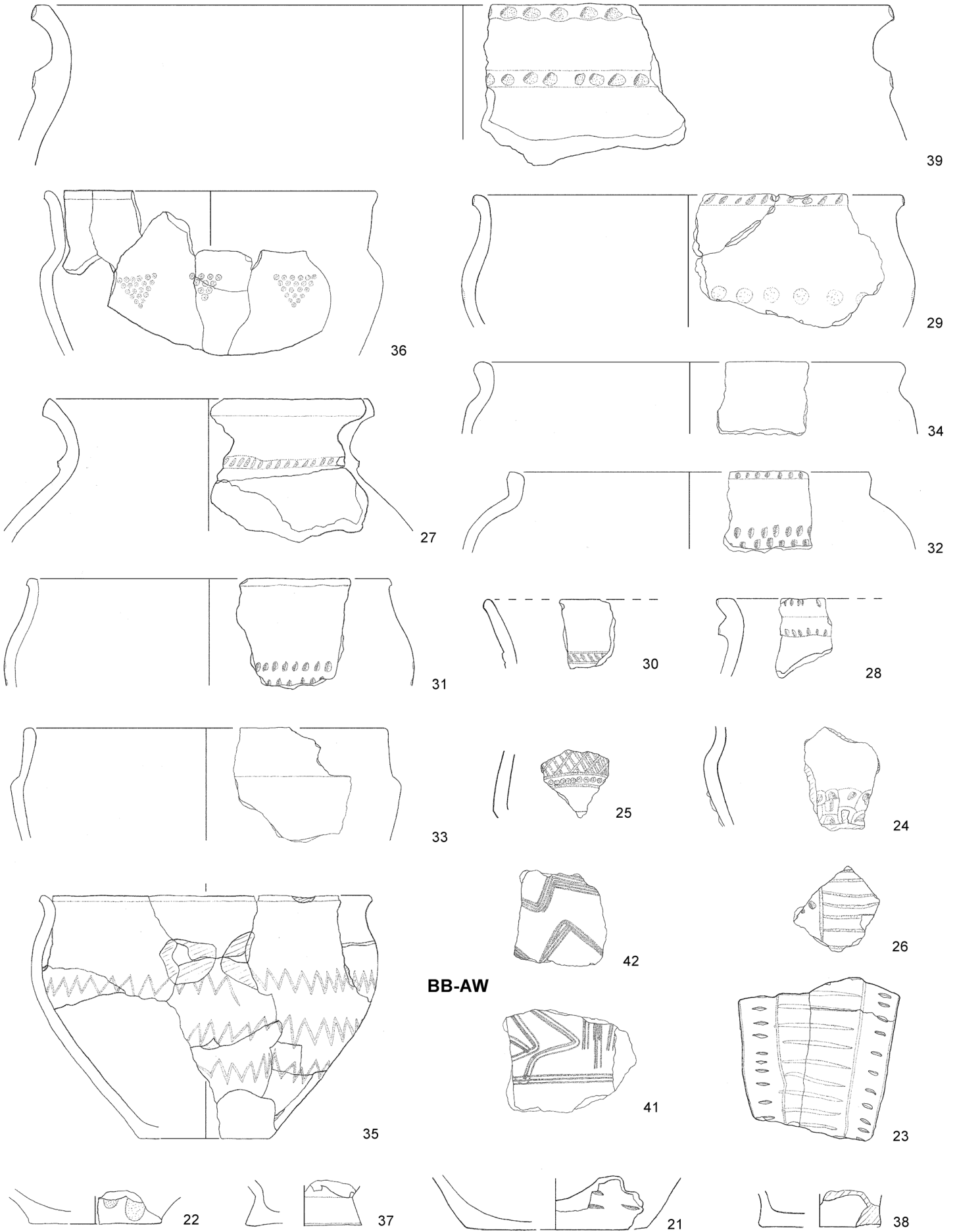

Enger-Bachbett, Auswahl (F.-Nr. 21-42); M 1:3.

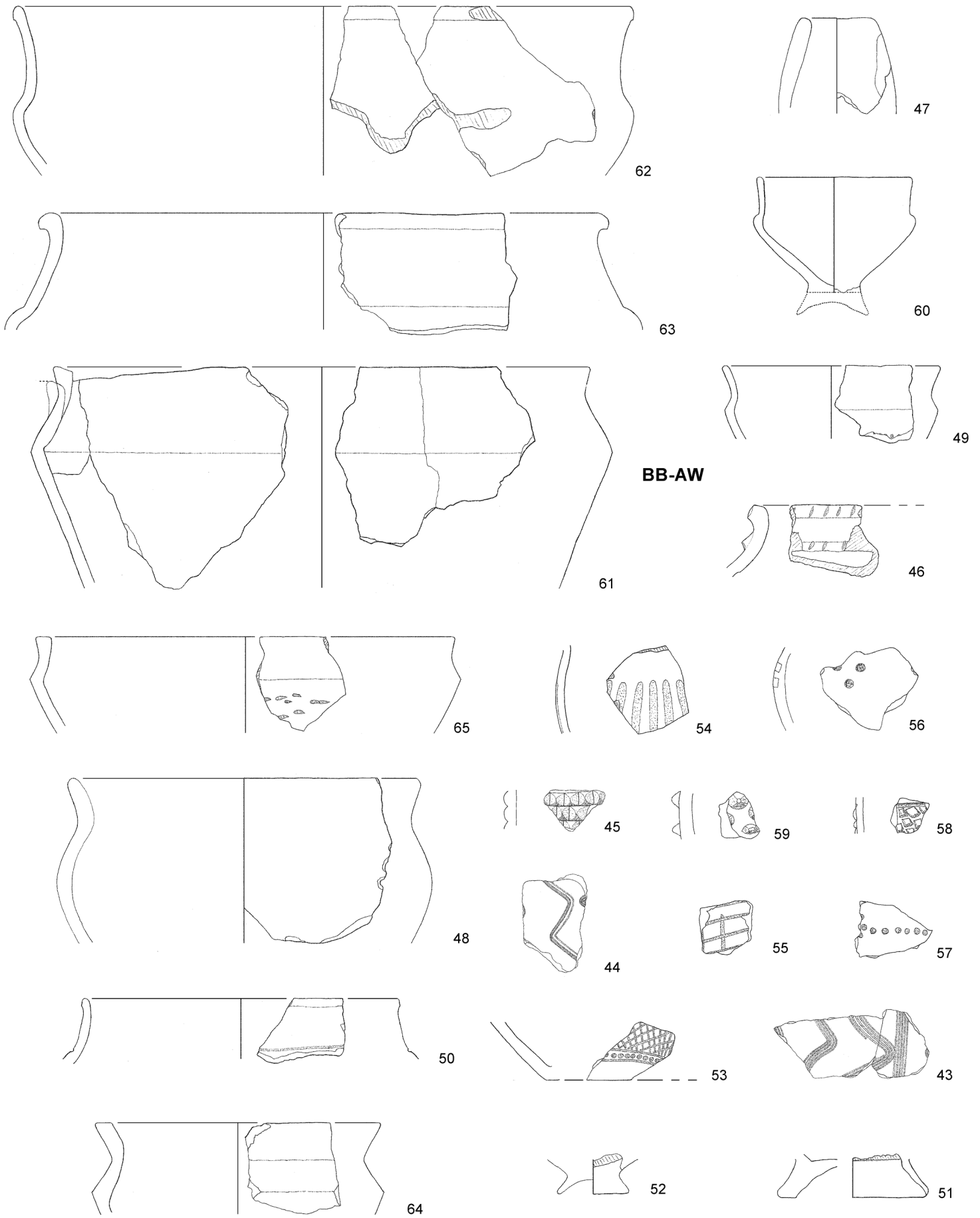

Enger-Bachbett, Auswahl (F.-Nr. 43-65); M 1:3.

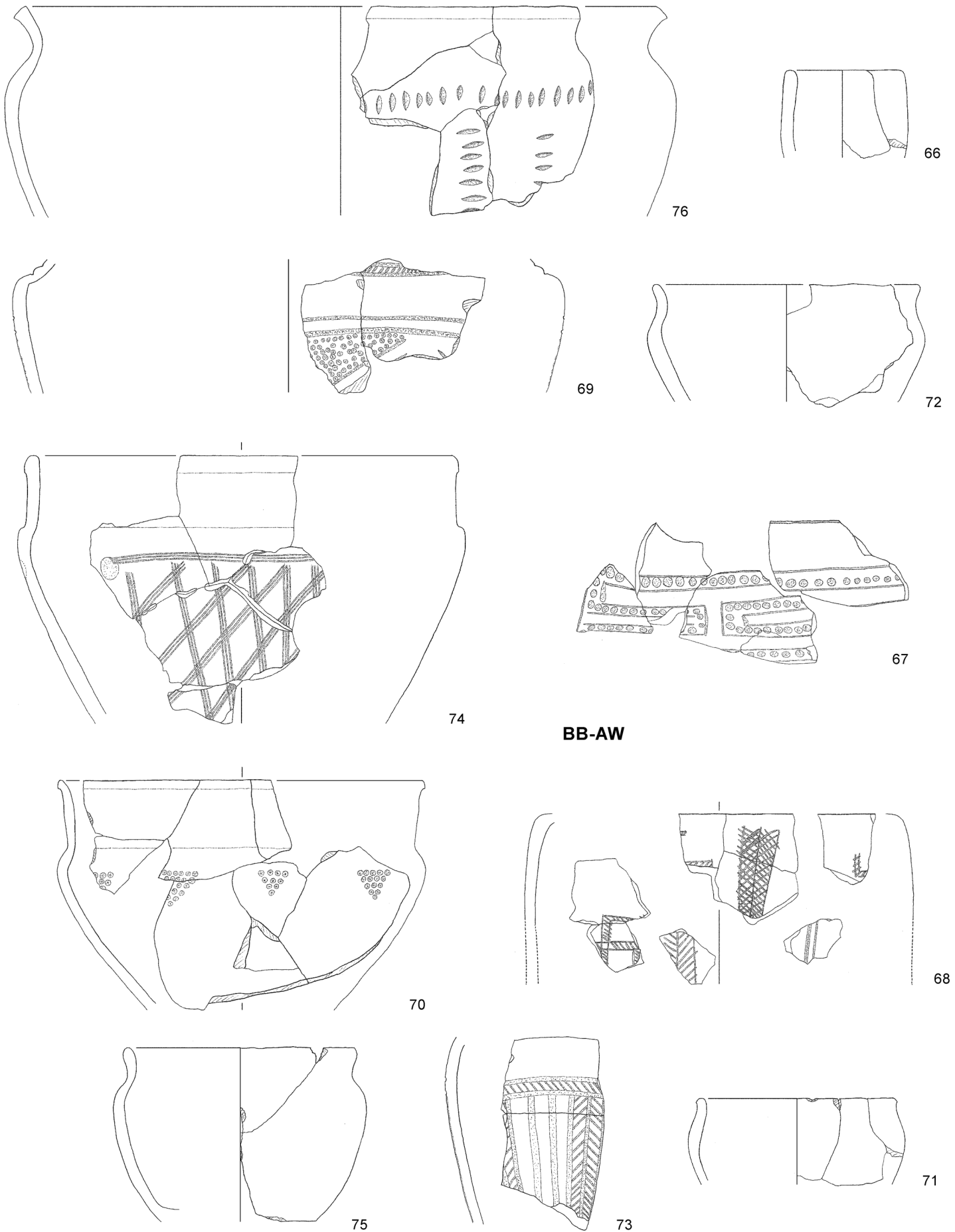

BB-AW

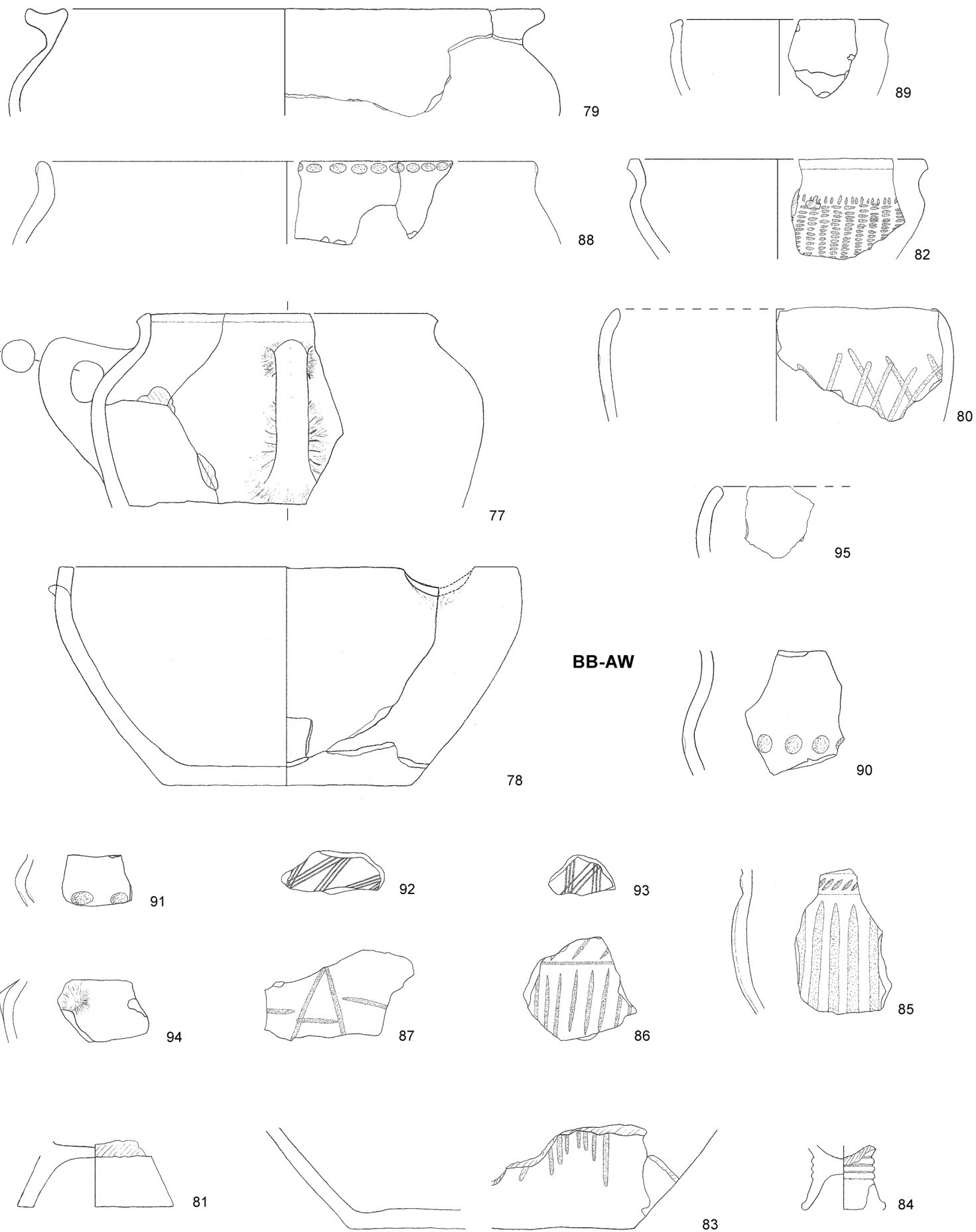

BB-AW

Enger-Bachbett, Auswahl (F.-Nr. 77-95); M 1:3.

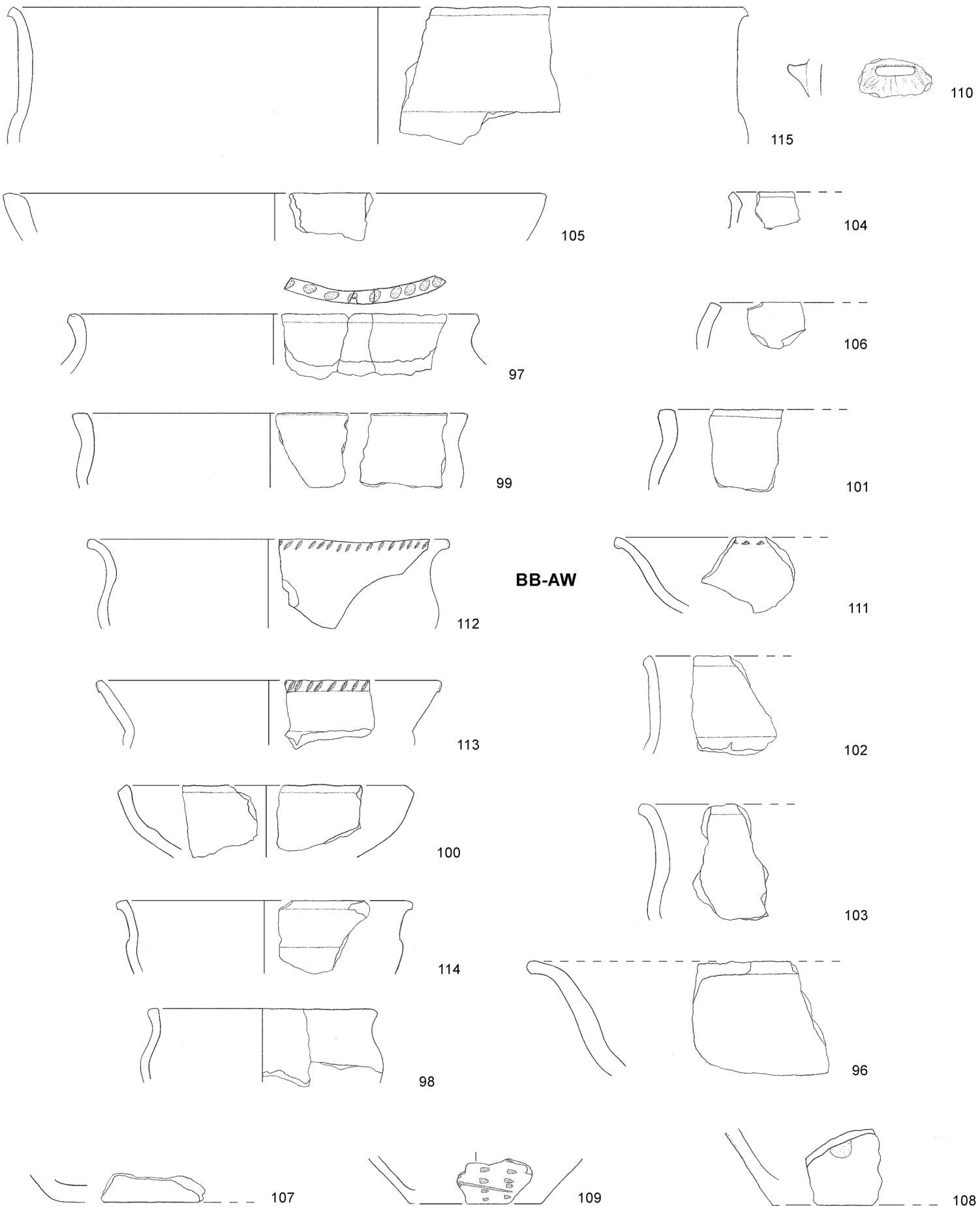

Enger-Bachbett, Auswahl (F.-Nr. 96-115); M 1:3.

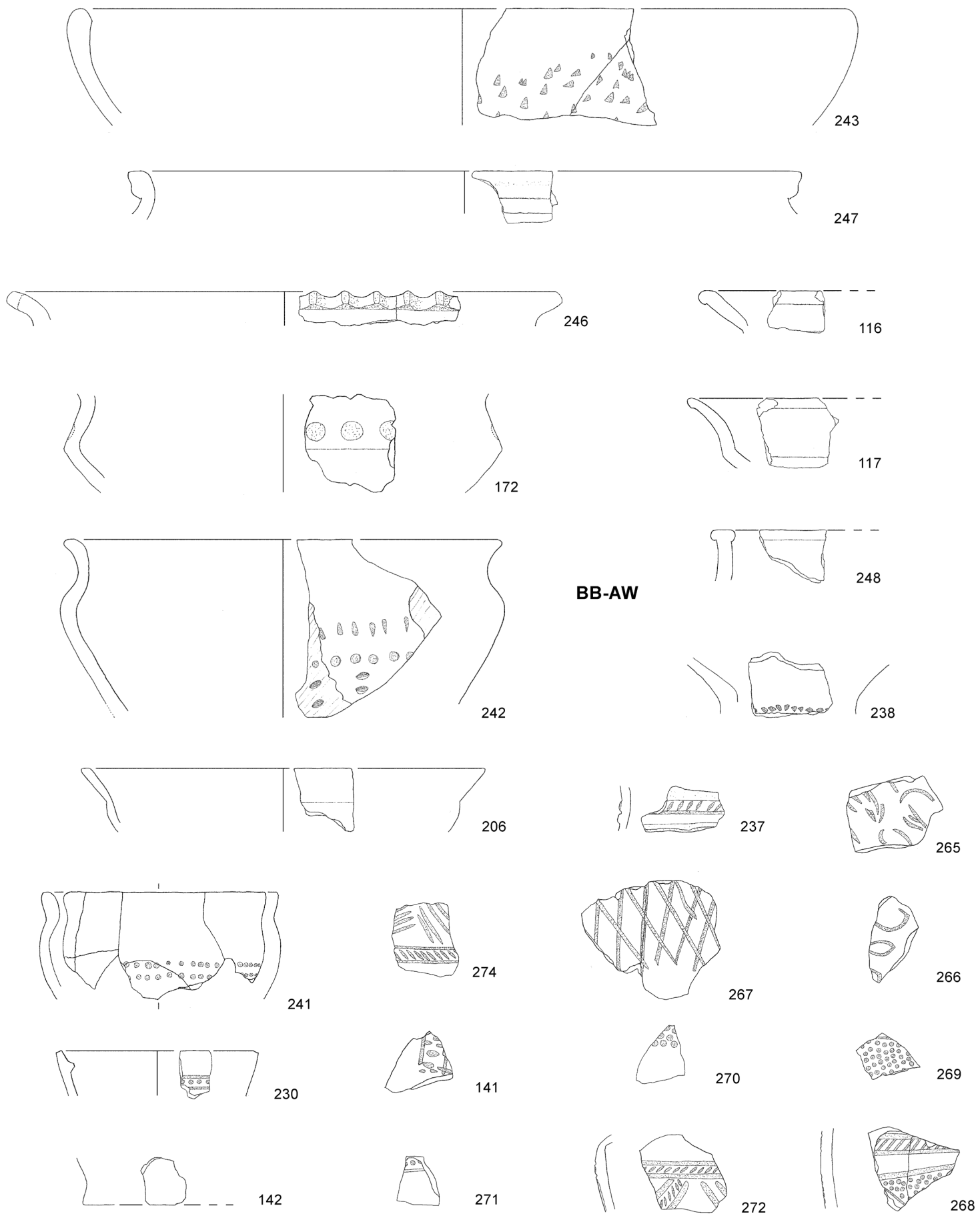

Enger-Bachbett, Auswahl (F.-Nr. 116-274); M 1:3.

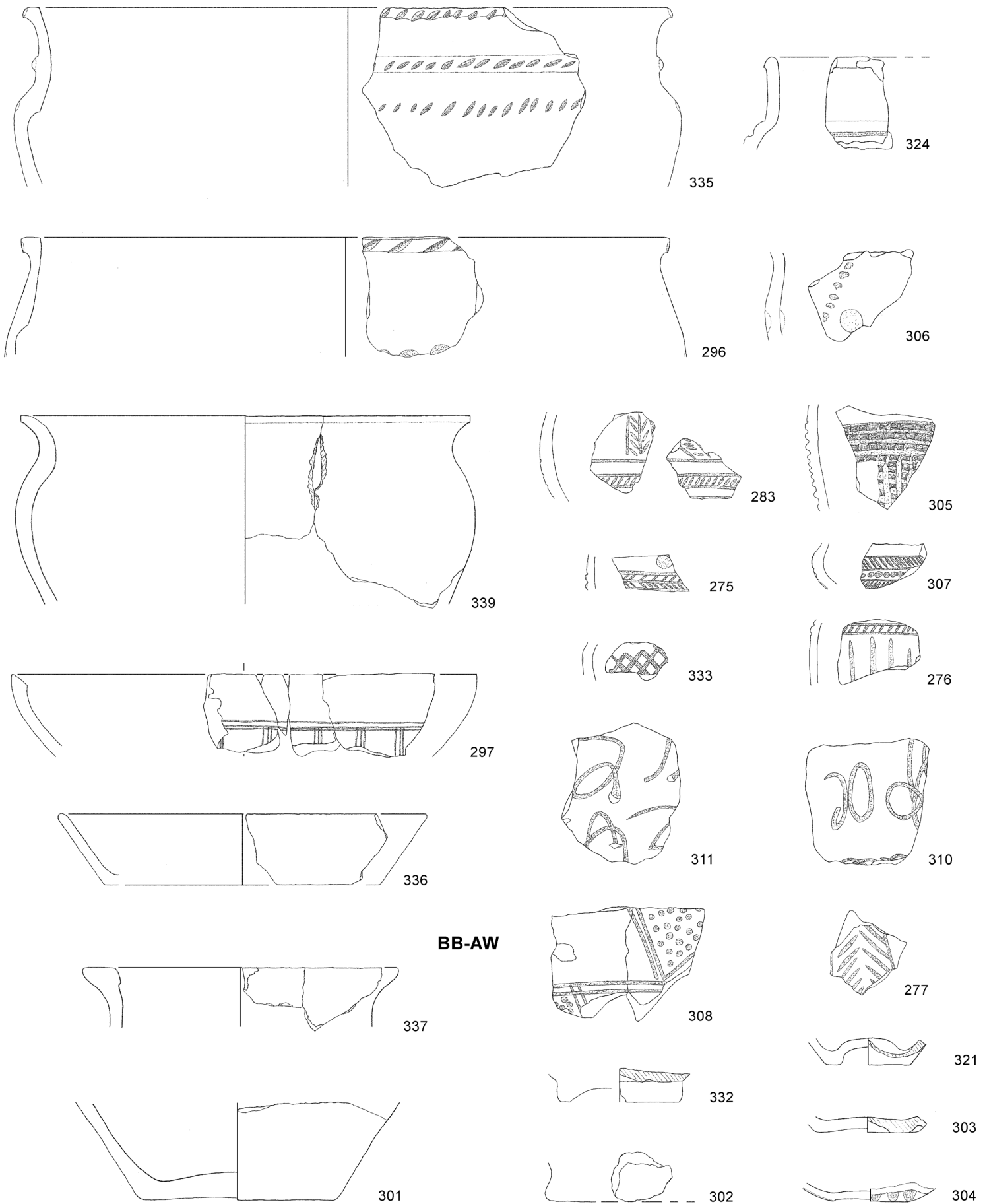

Enger-Bachbett, Auswahl (F.-Nr. 275-339), M 1:3.

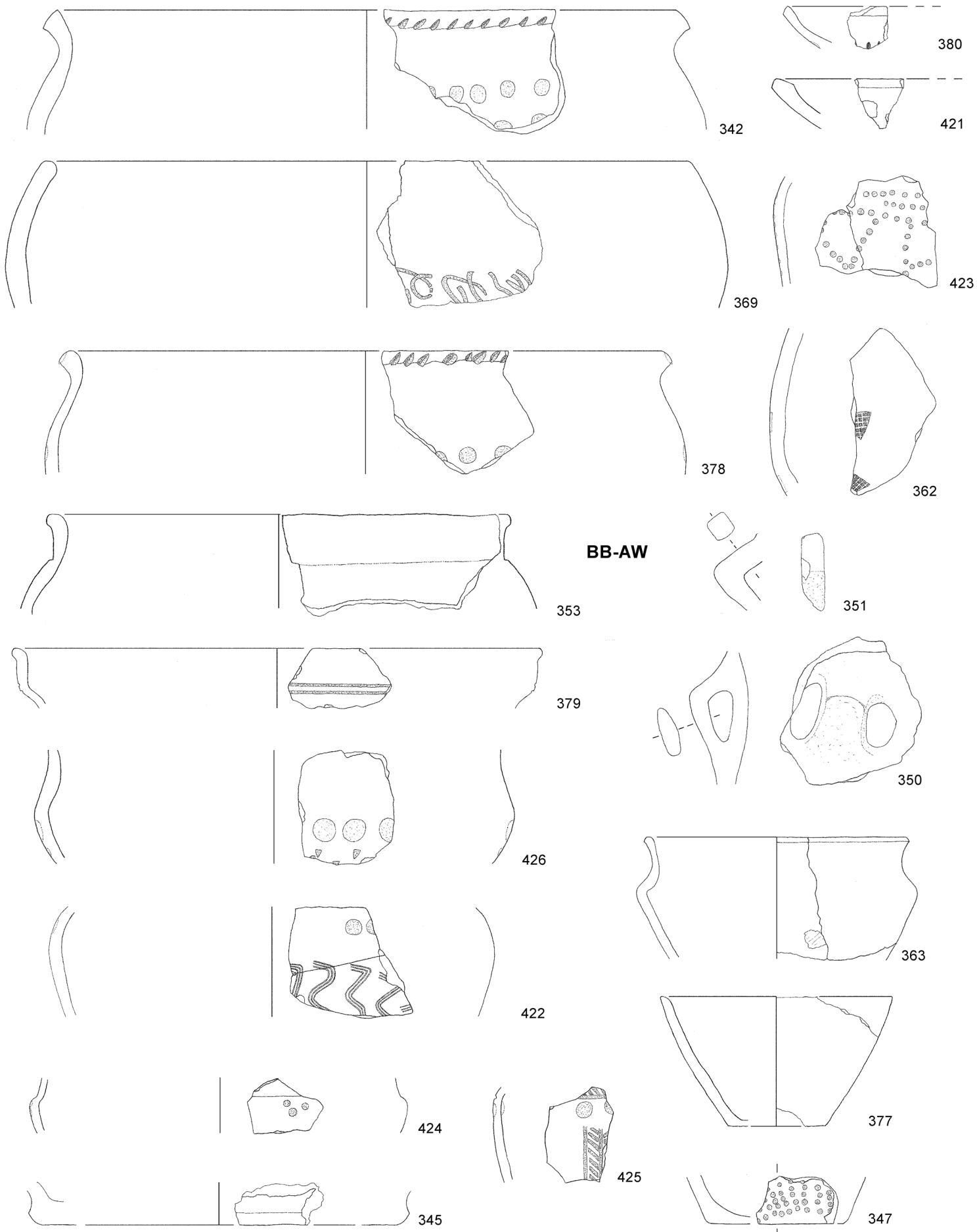

Enger-Bachbett, Auswahl (F.-Nr. 342-426); M 1:3.

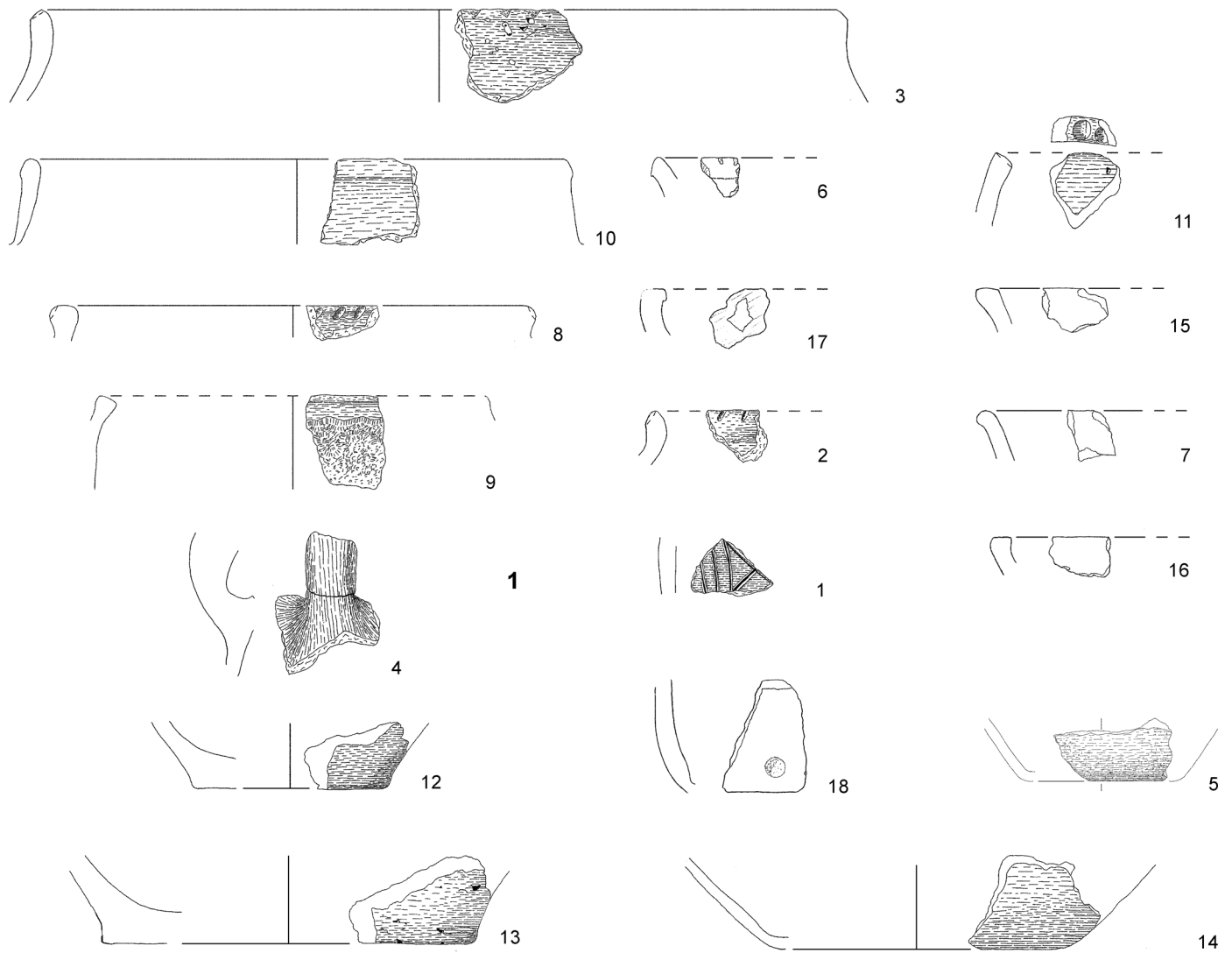
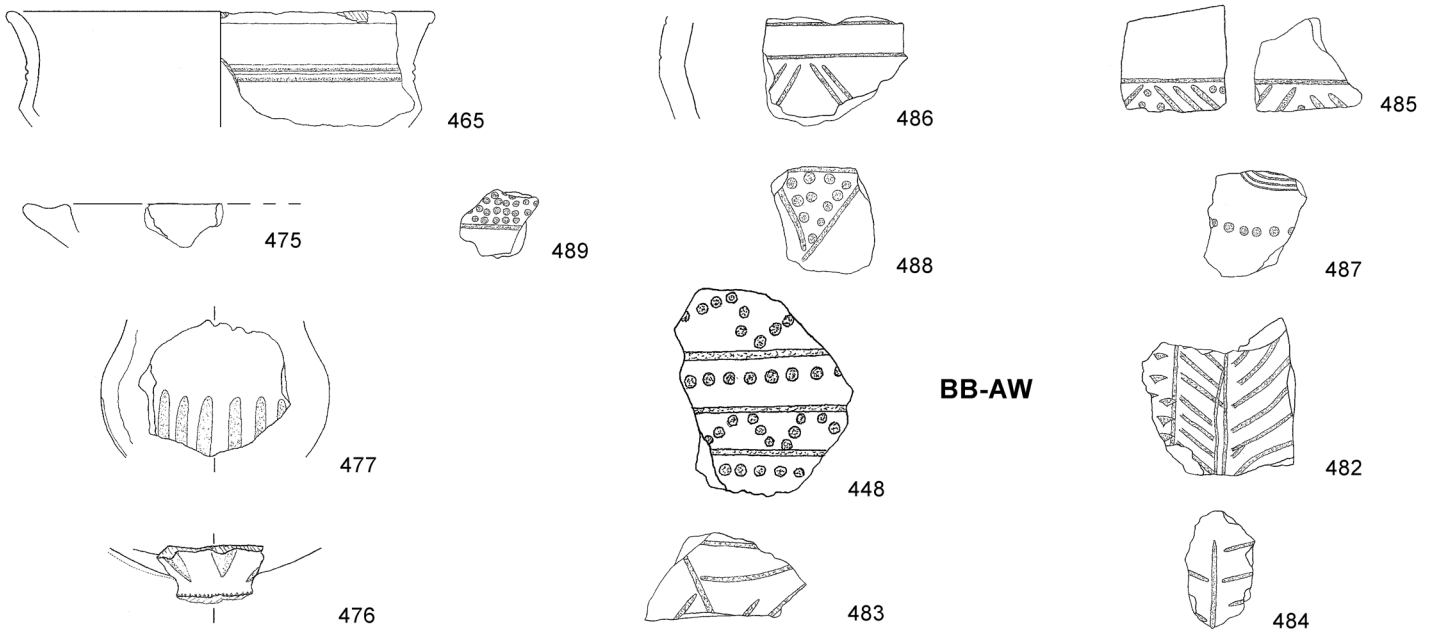

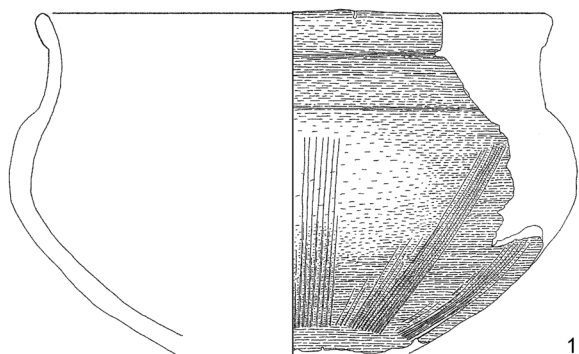

1

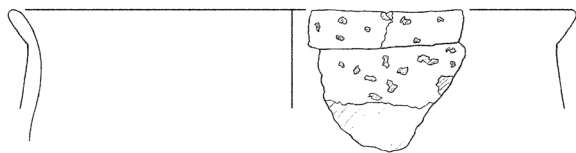

2

3



10

35

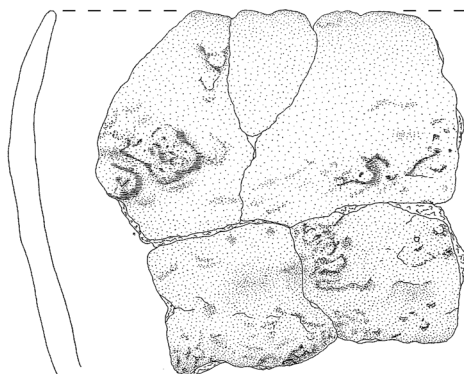

4

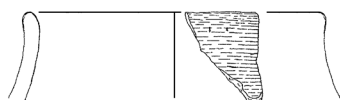

1

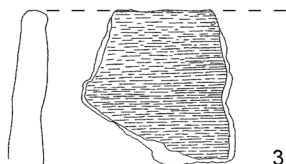

3



2



1

53

83



1



1

87

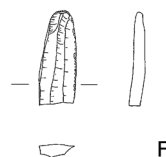

F

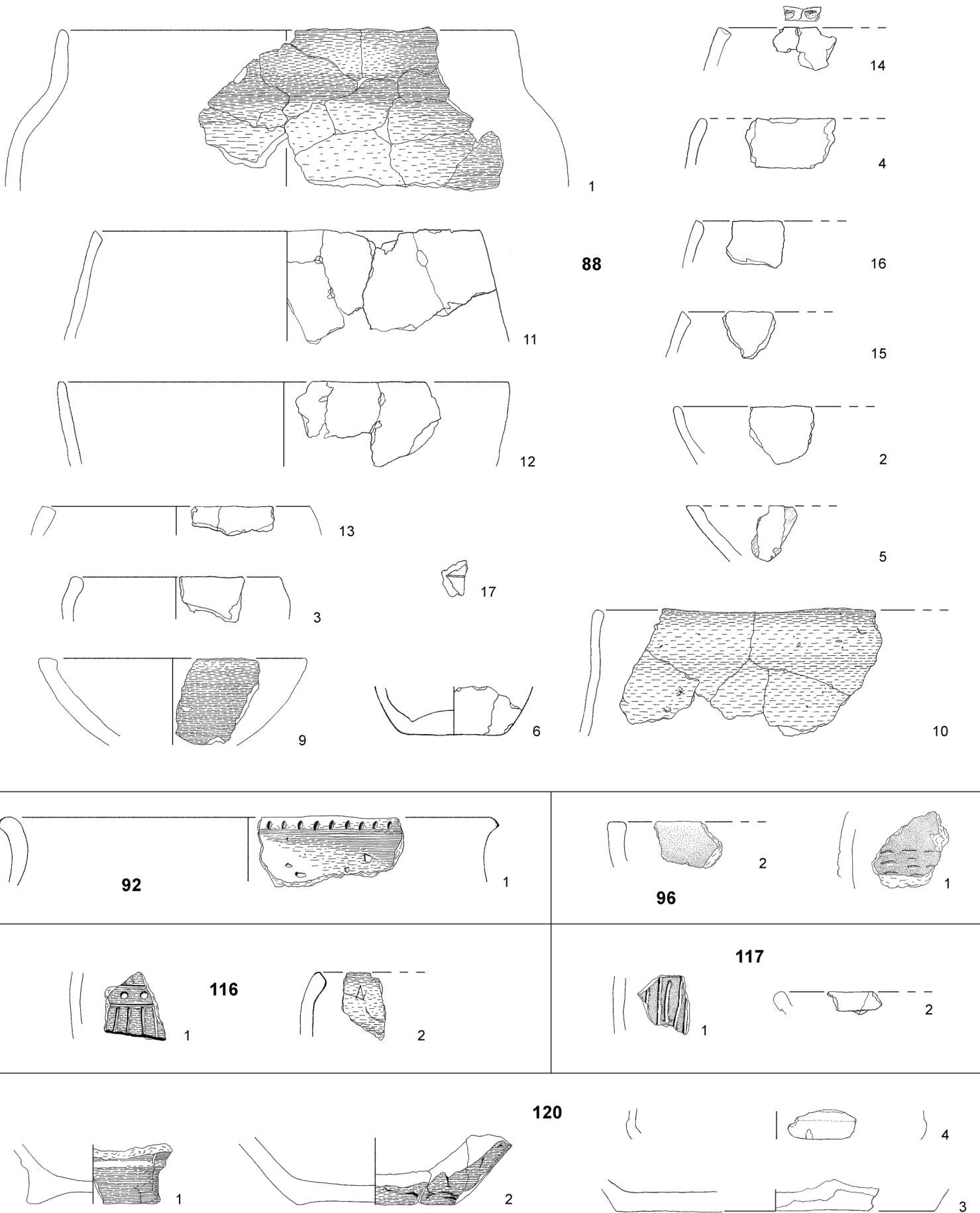

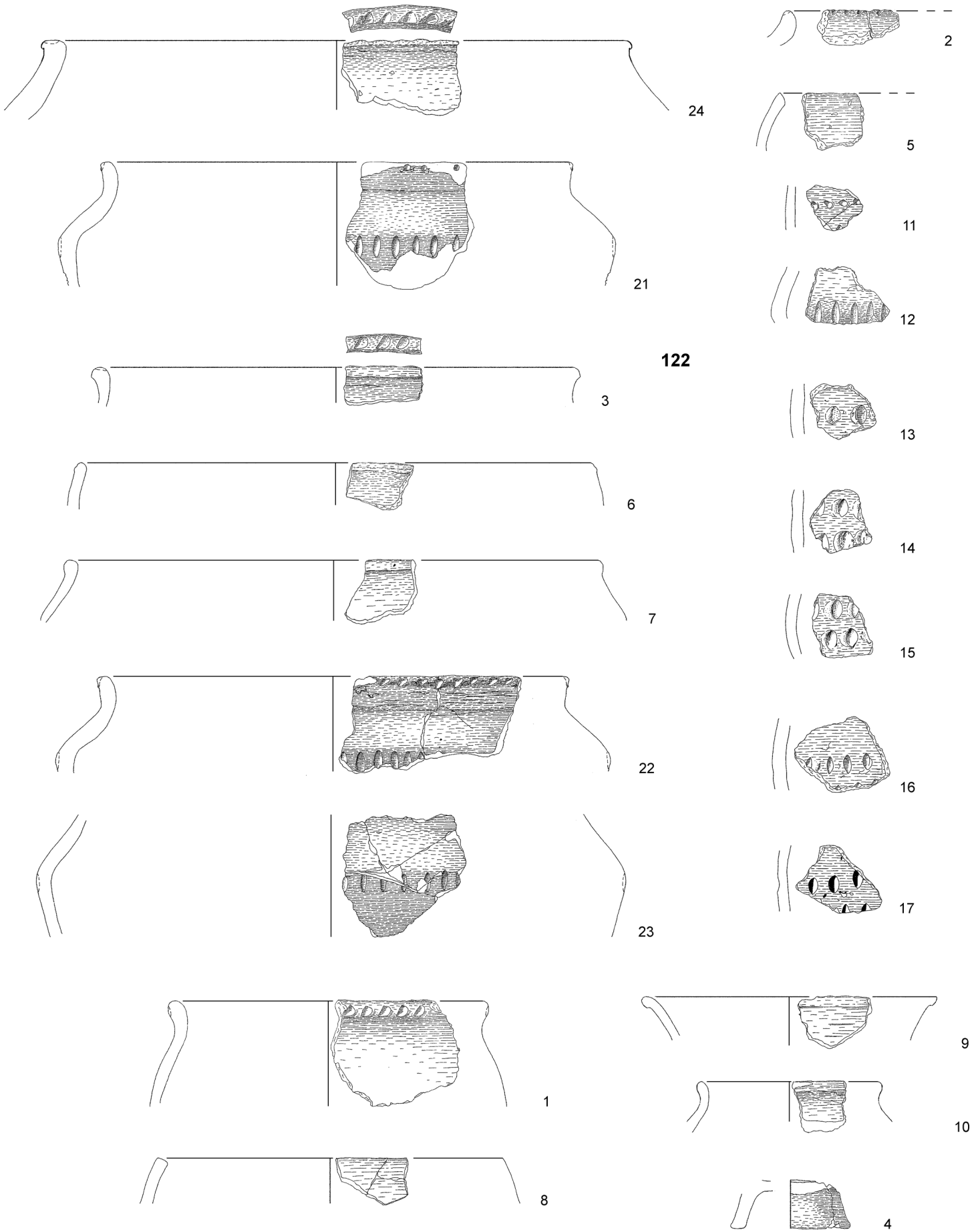

Hüllhorst 1999, Befund 122 (F.-Nr. 1-24); M 1:3.

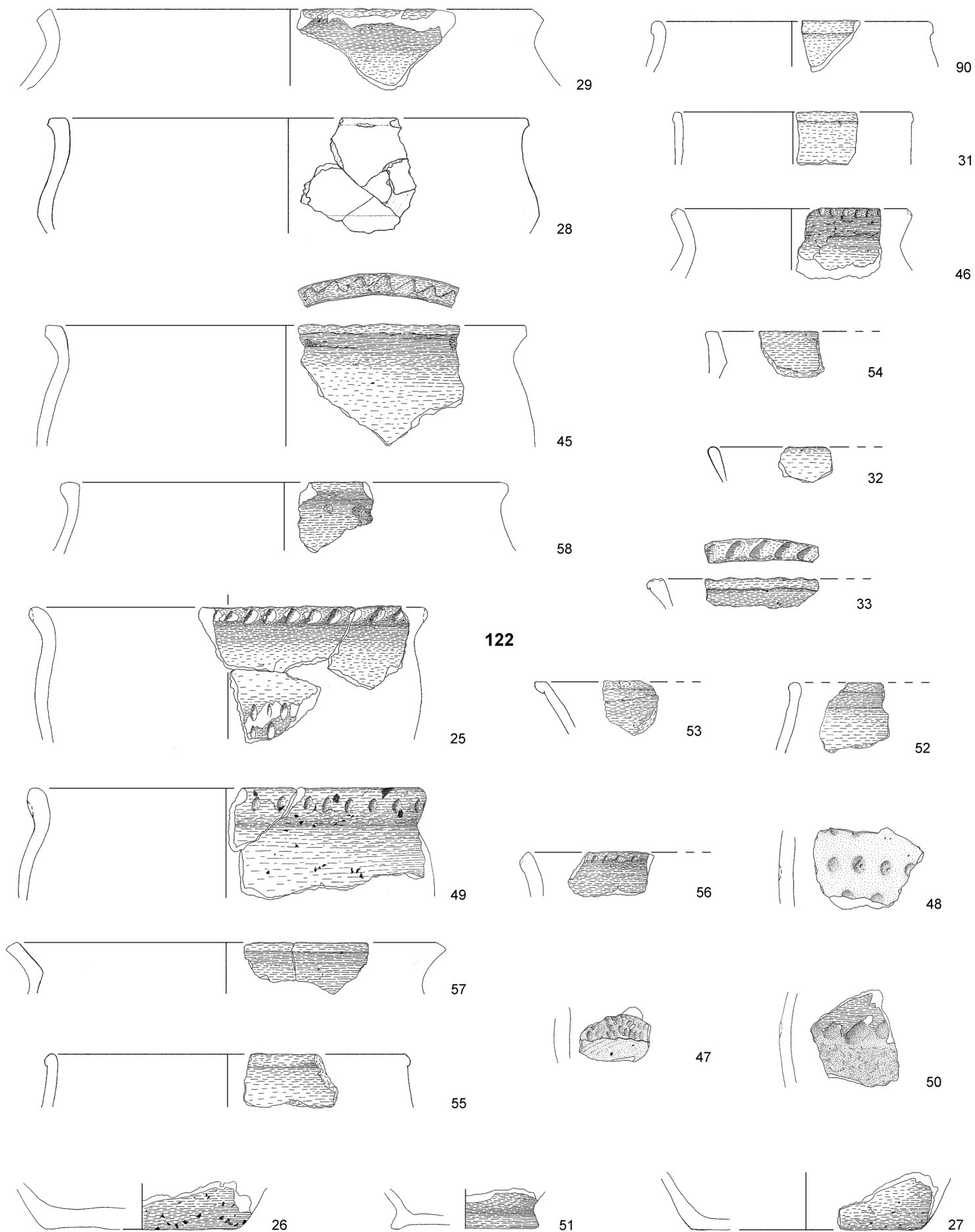

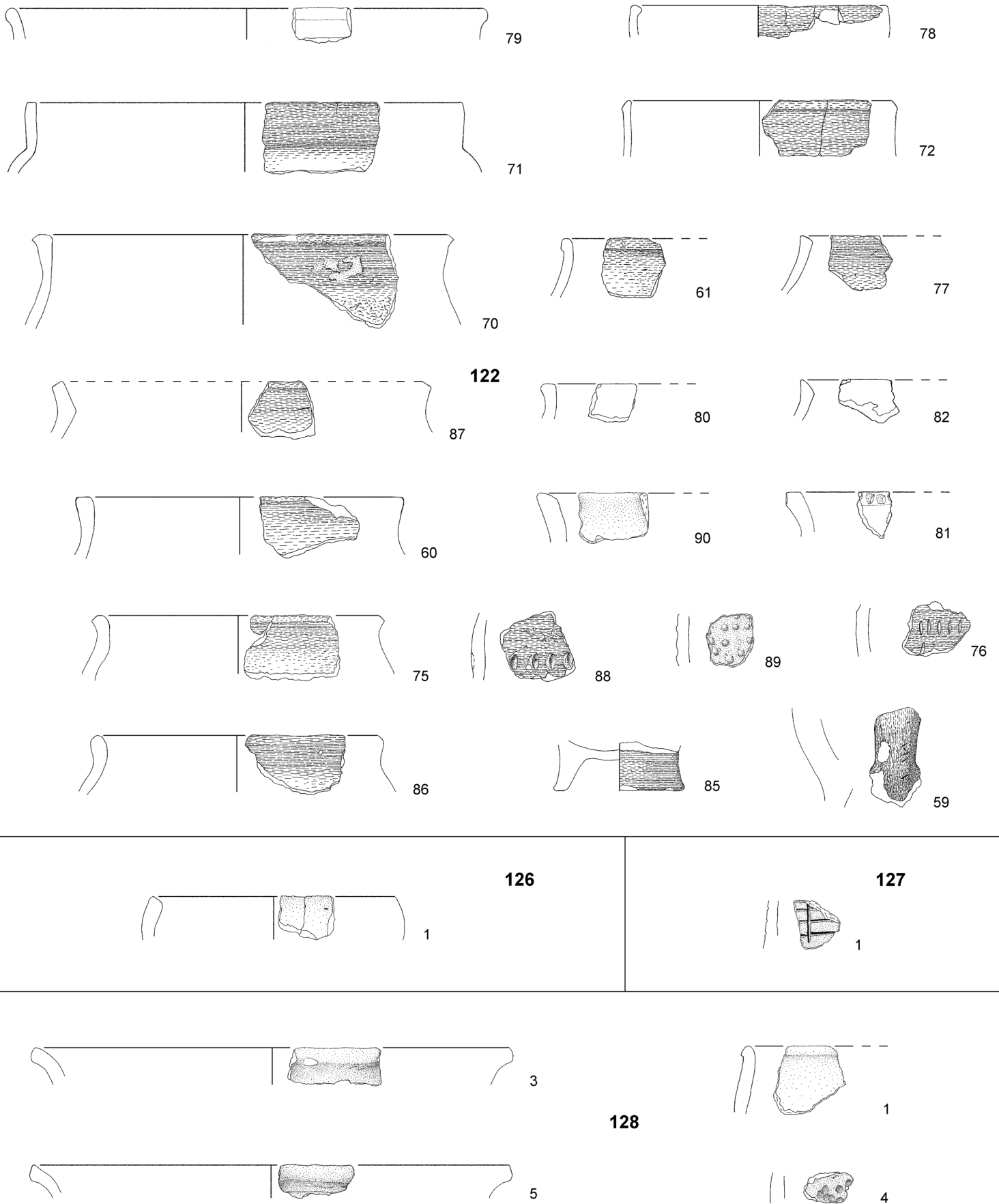

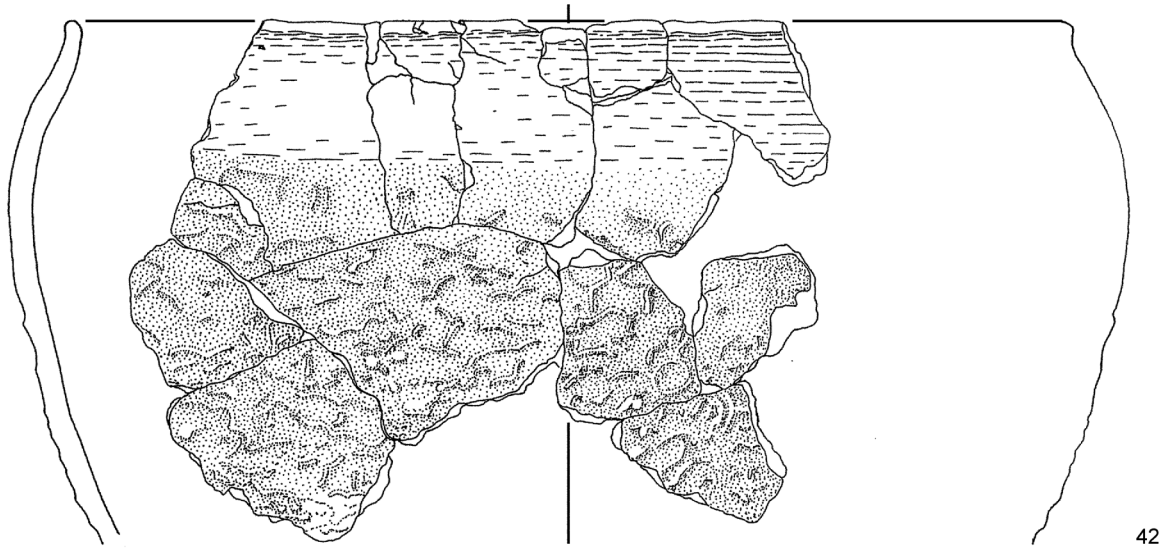

42

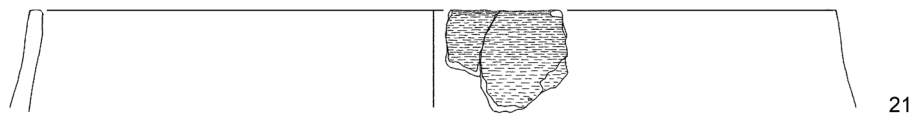

21

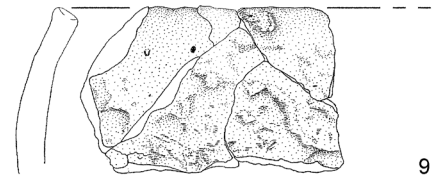

9

149

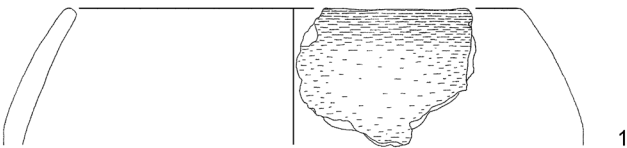

1

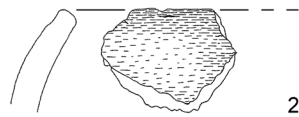

2



11

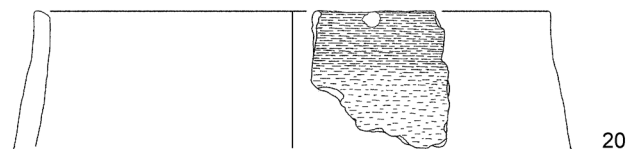

20

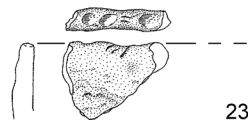

23

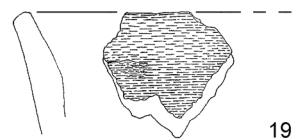

19

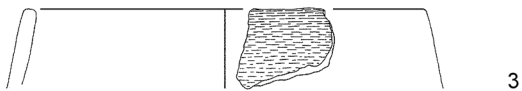

3



24



12

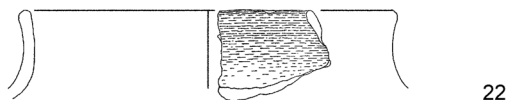

22



13



53

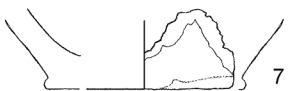

7



8



44

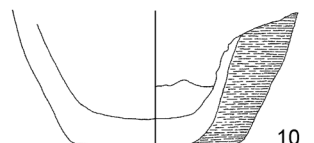

10

149

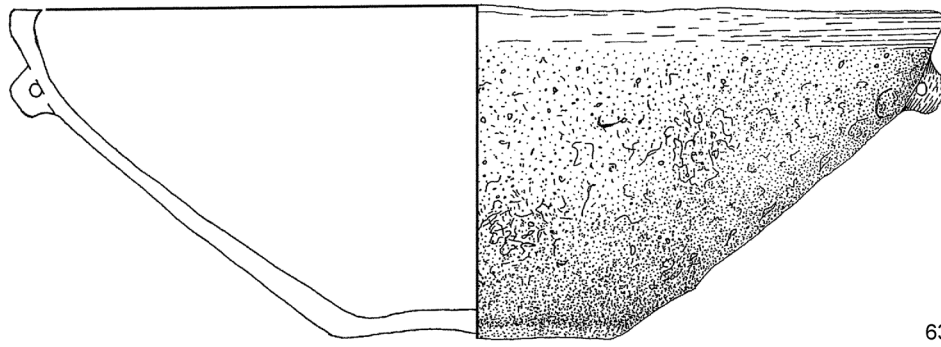

63

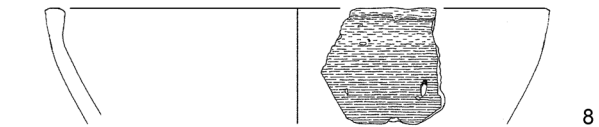

8

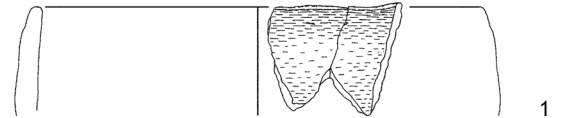

1

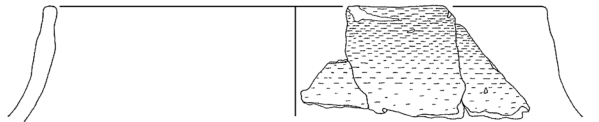

9

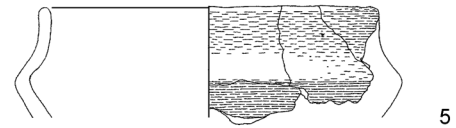

5

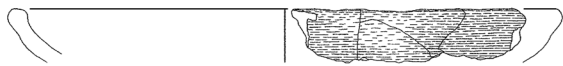

4

150

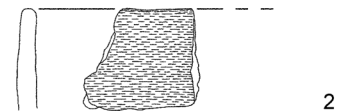

2

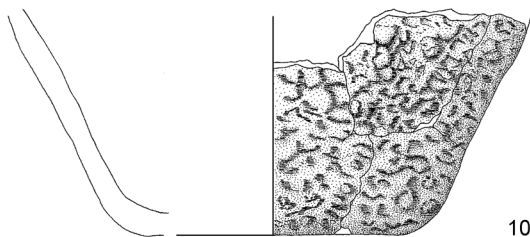

10



3

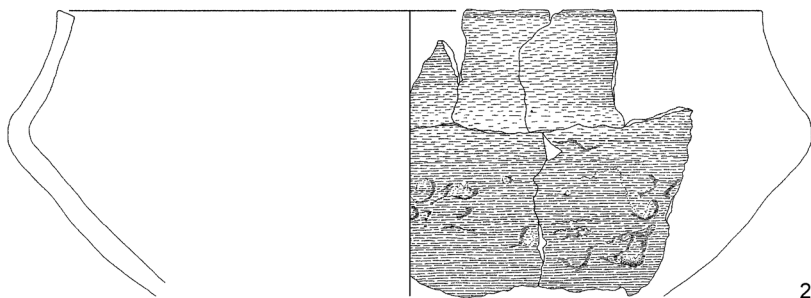

2

151

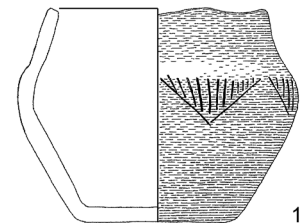

1



8

161

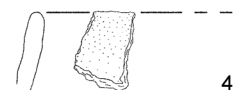

4

164

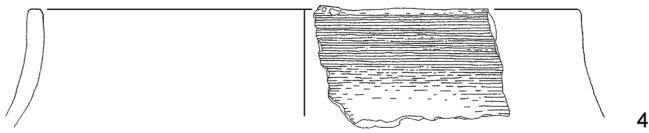

4

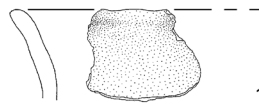

1

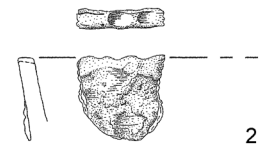

2

178



2



3



1

179

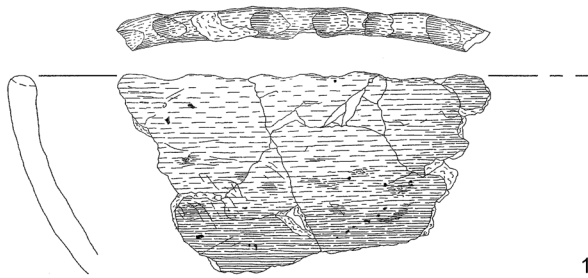

1

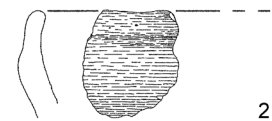

2

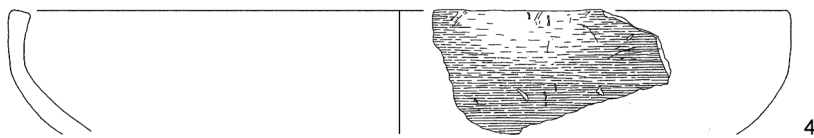

4

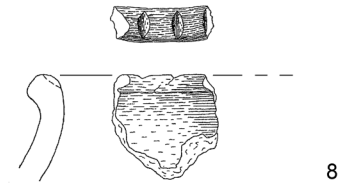

8

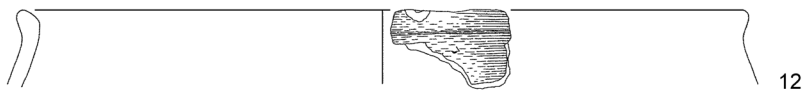

12

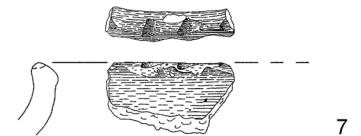

7

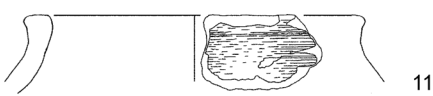

11

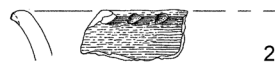

2

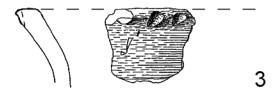

3

LF

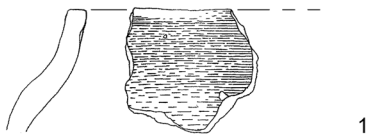

1

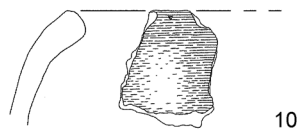

10

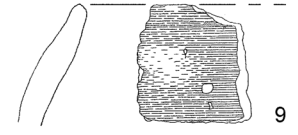

9

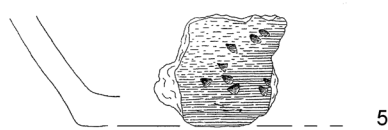

5



13



6

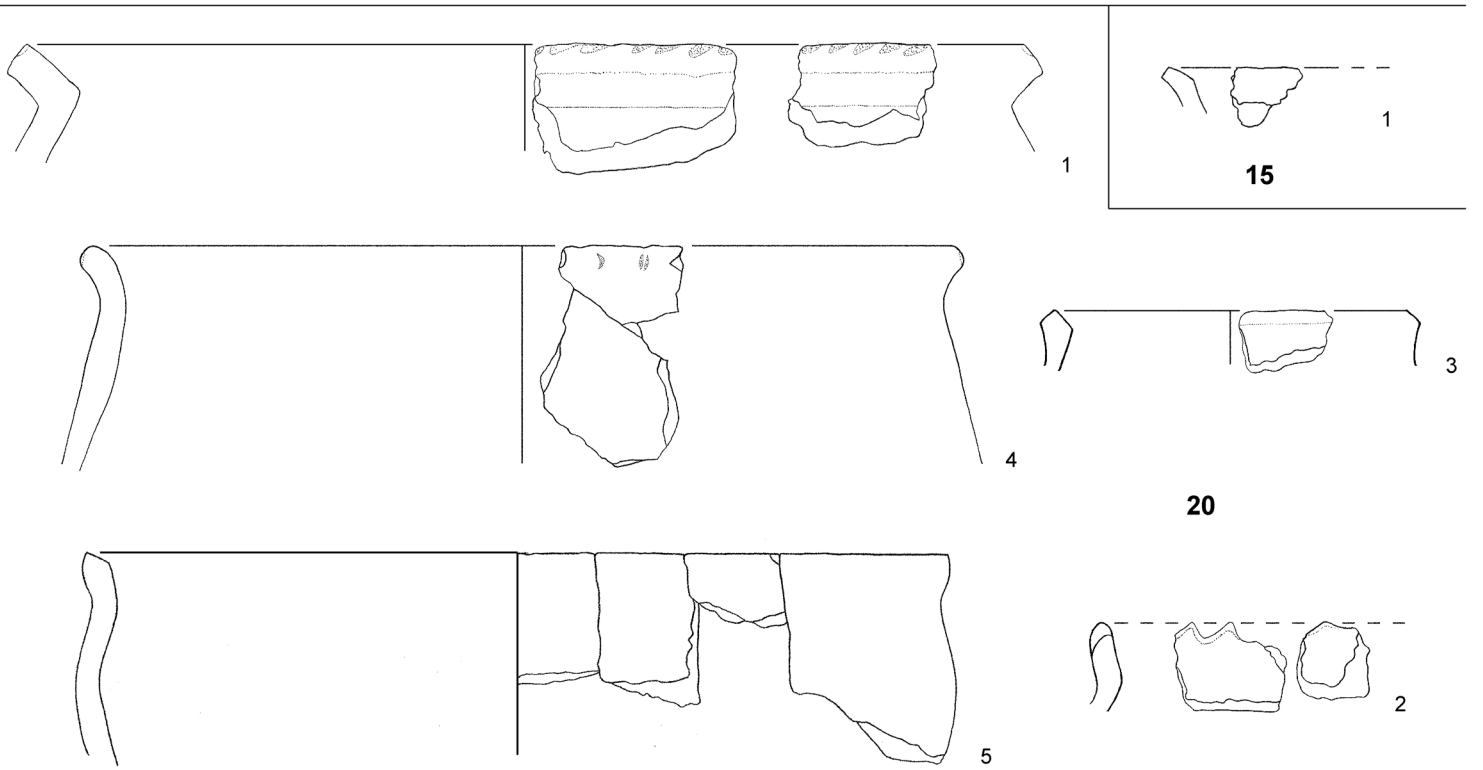
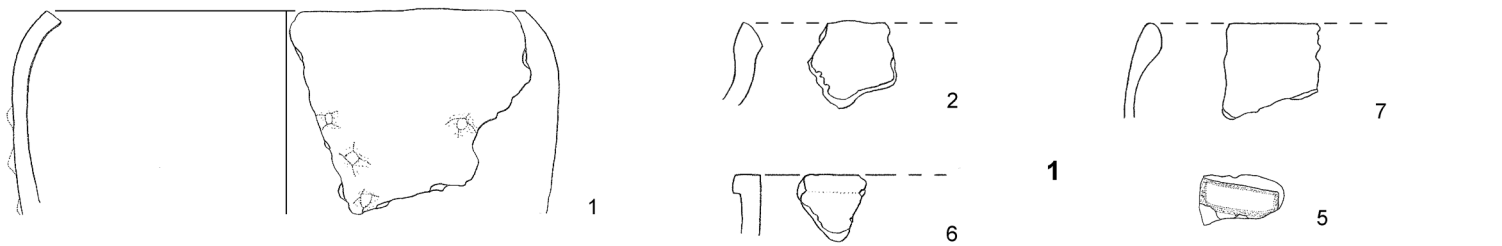
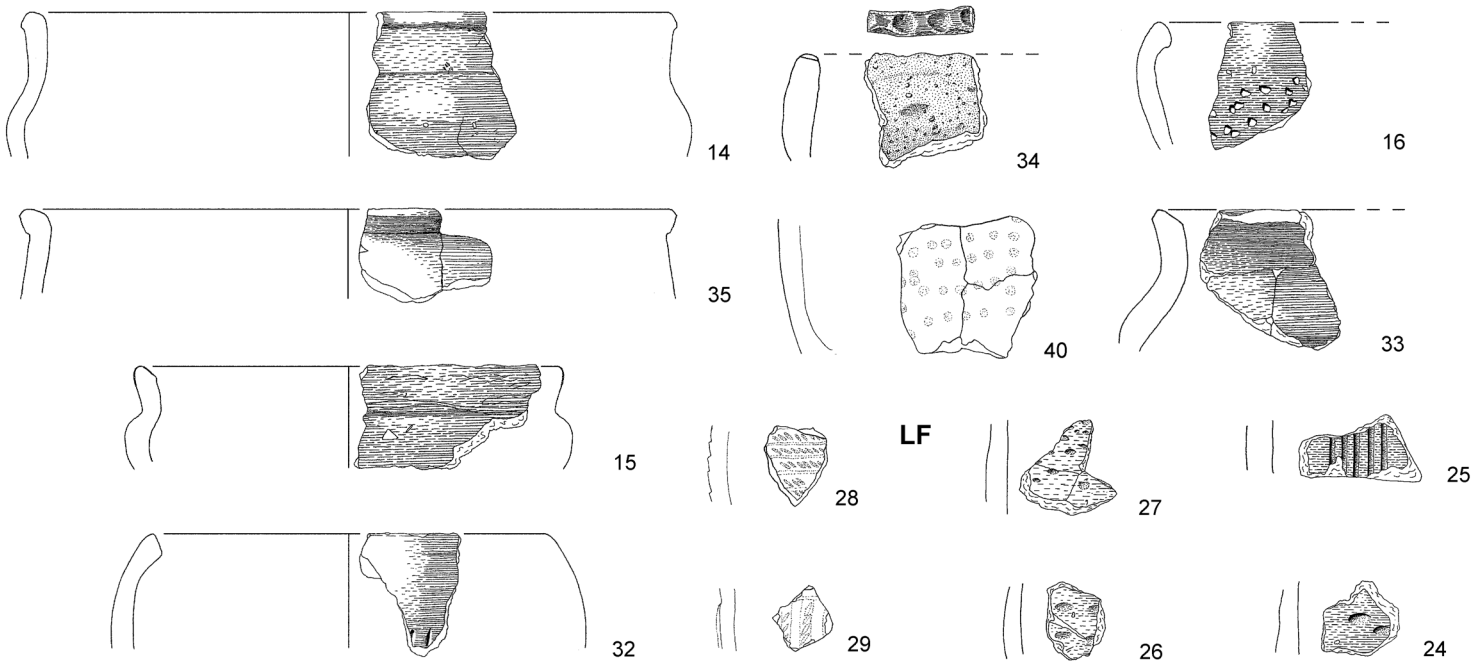

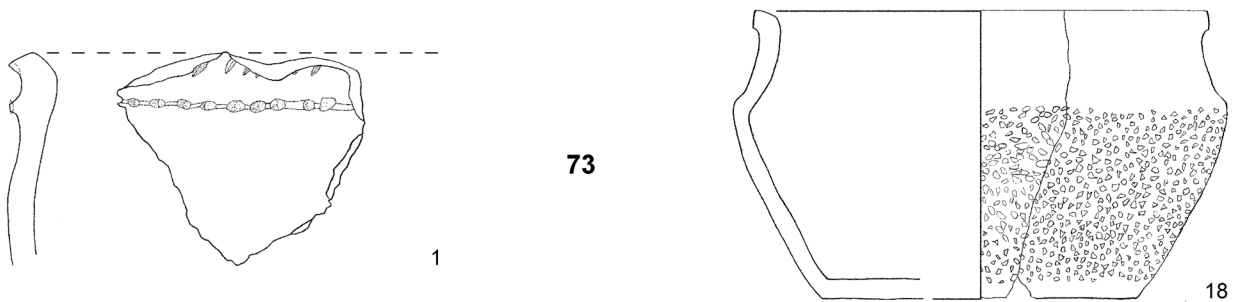
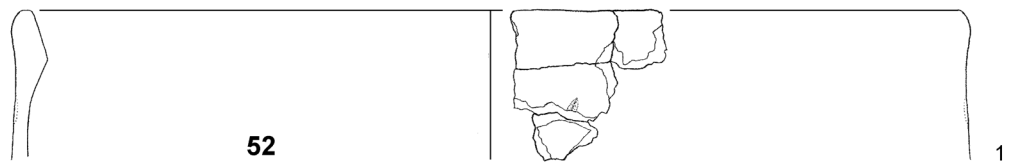
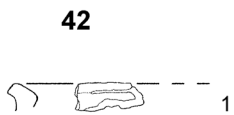
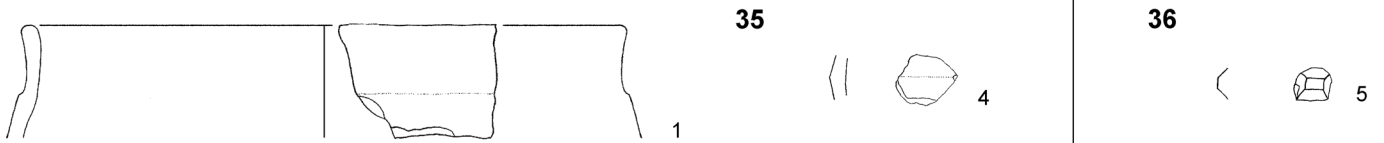
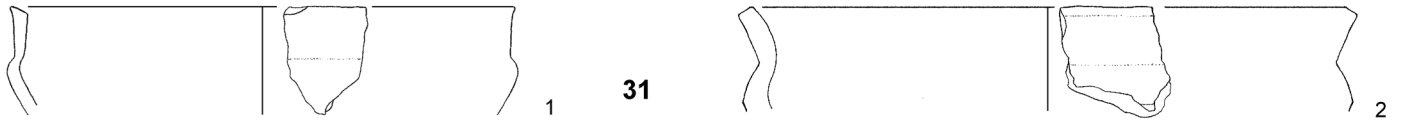
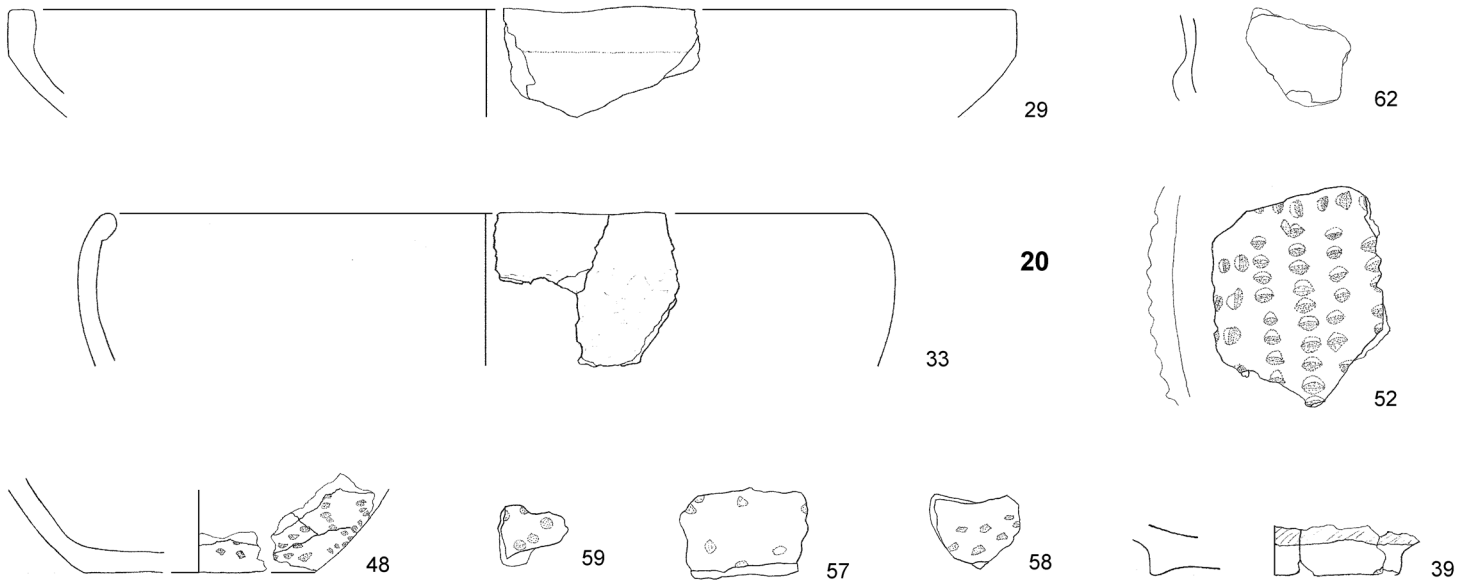



74

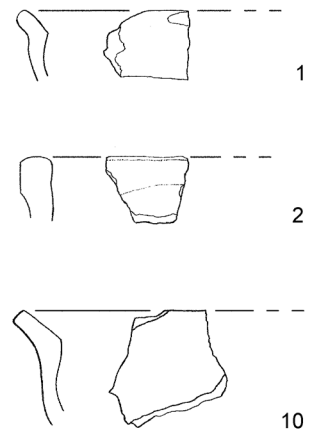

93

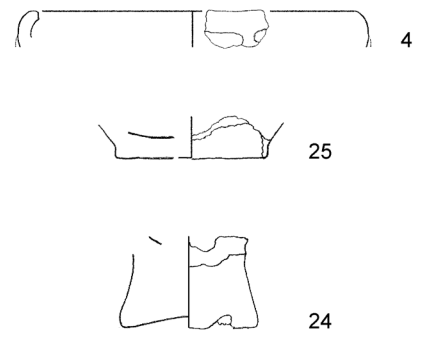
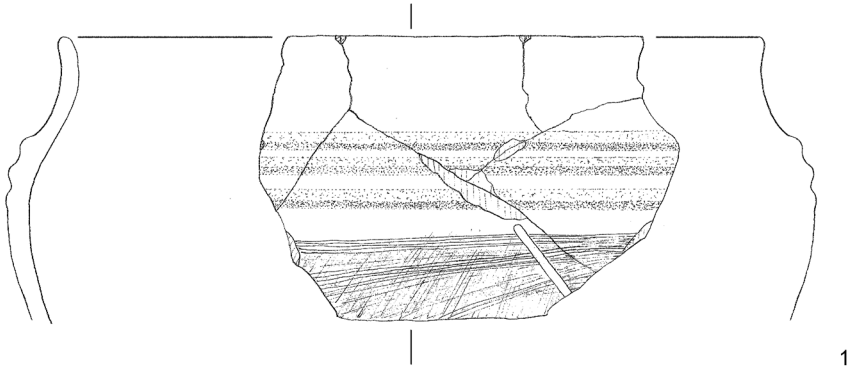

97

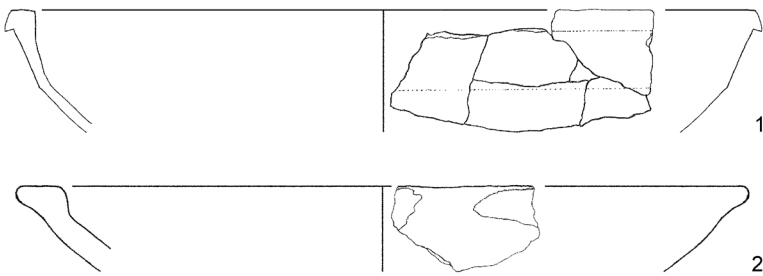

75

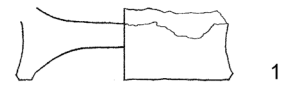

127

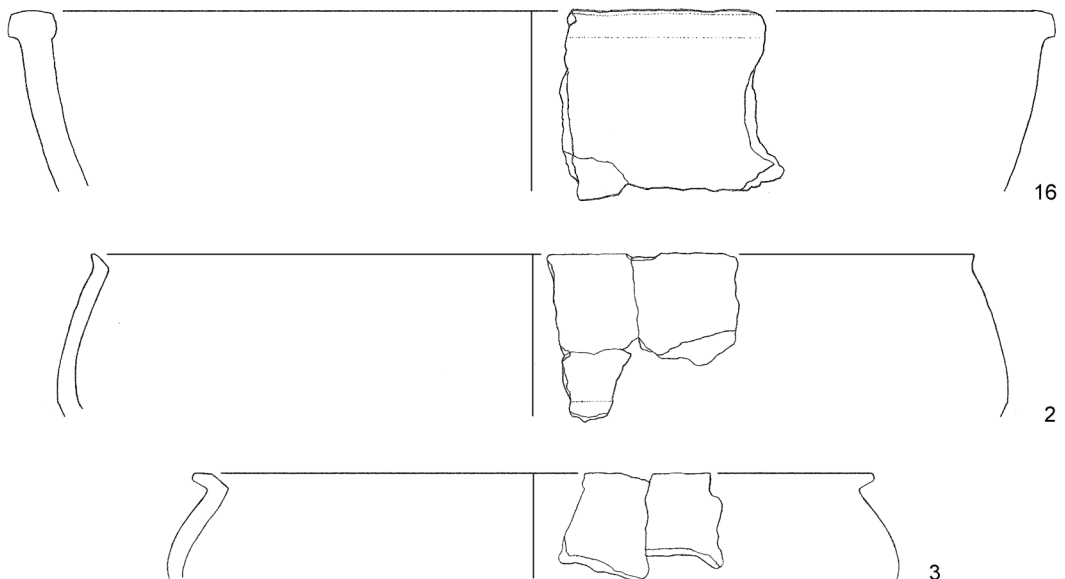

TAFEL 80

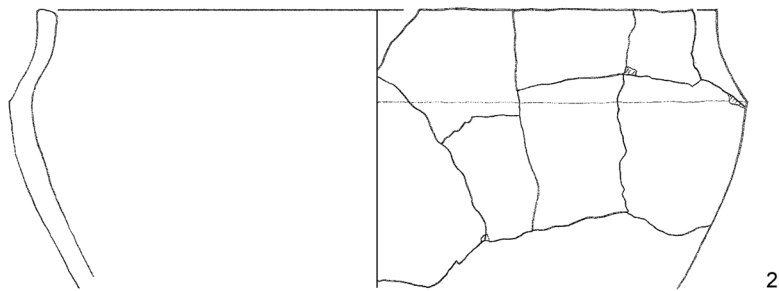
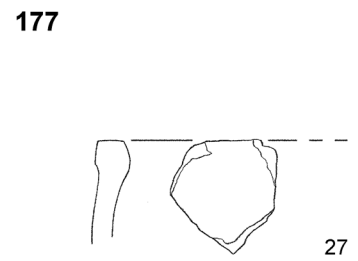
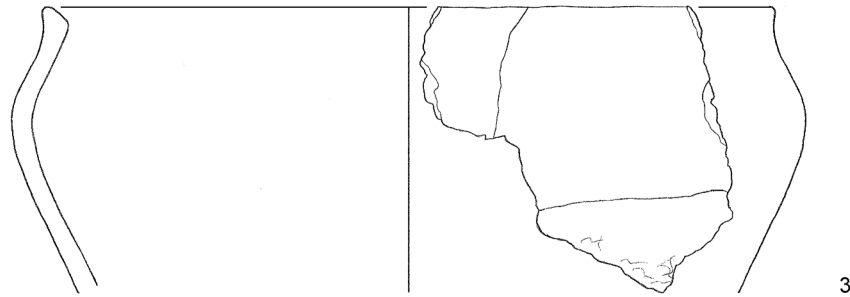
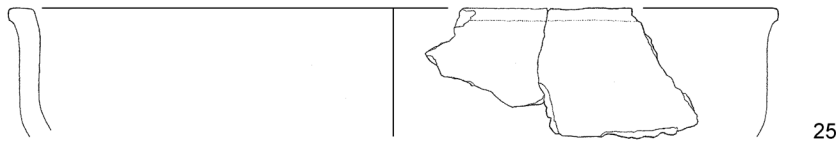
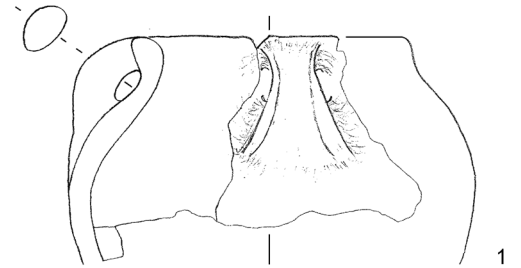
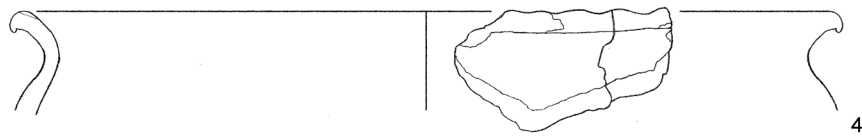
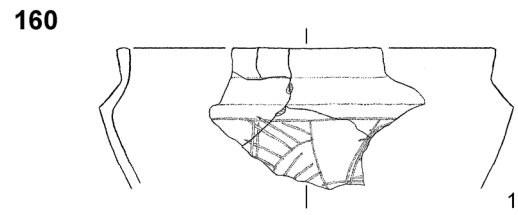
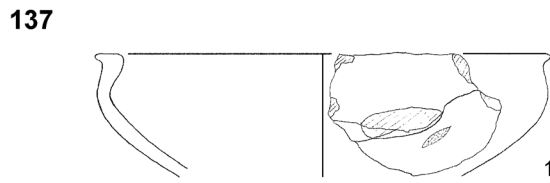
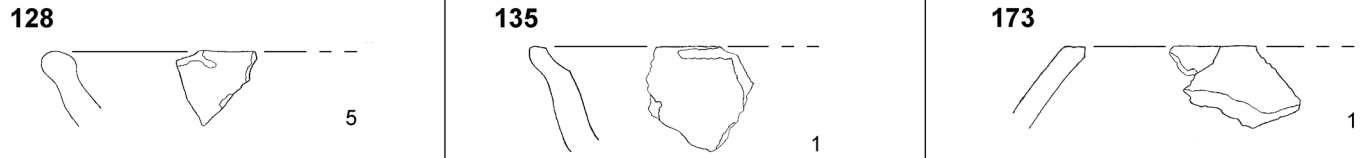

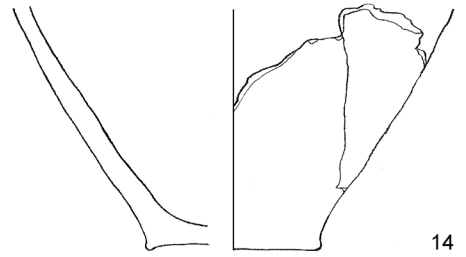
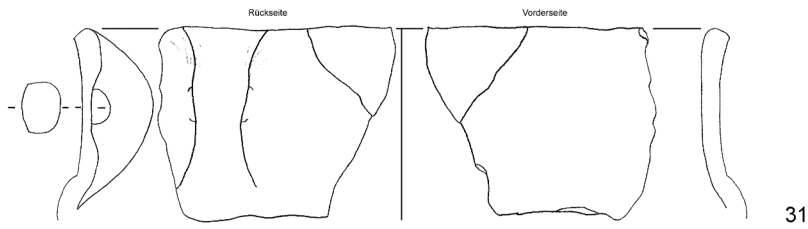

178

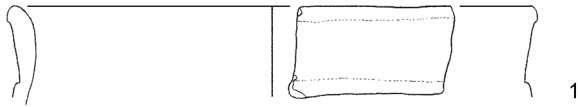

219



180

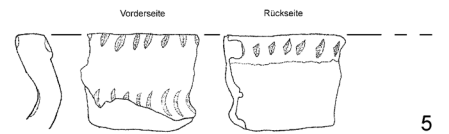
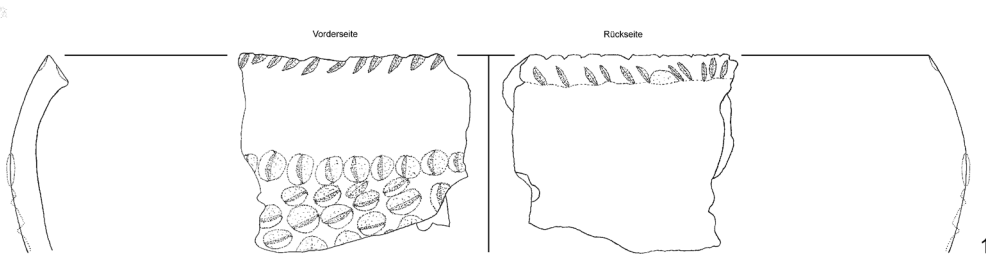
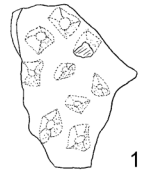

232

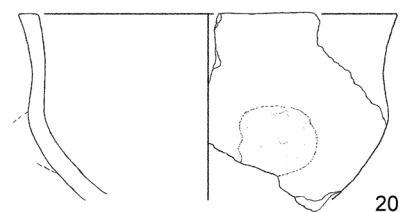
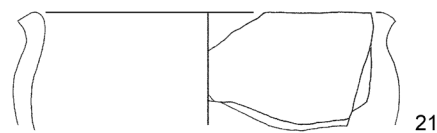
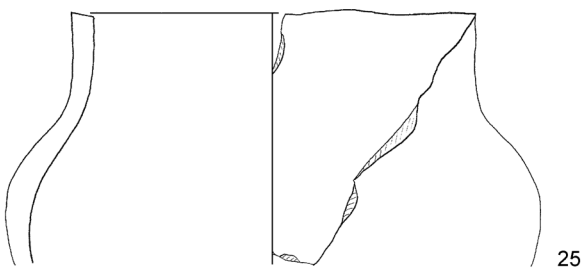
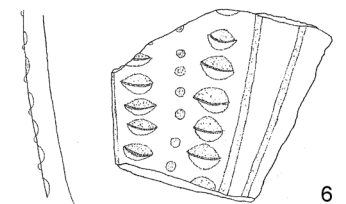
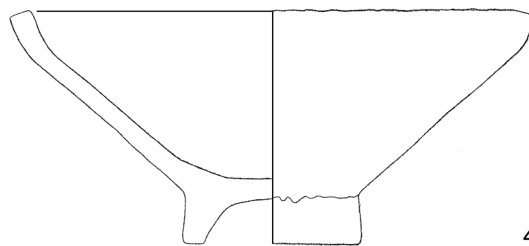
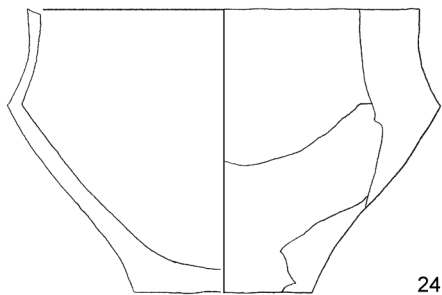

232

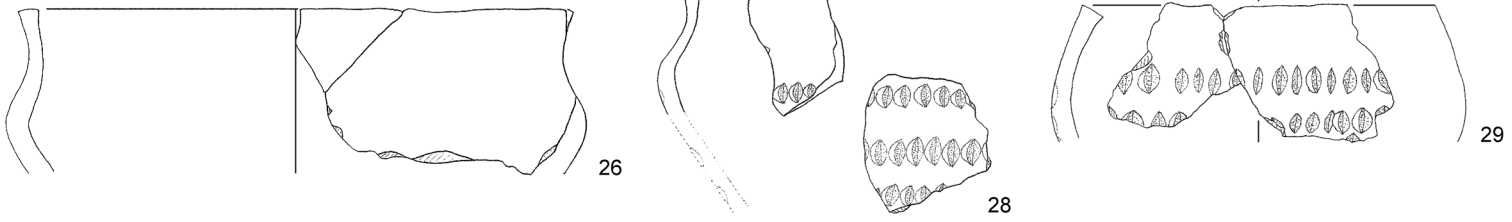

237

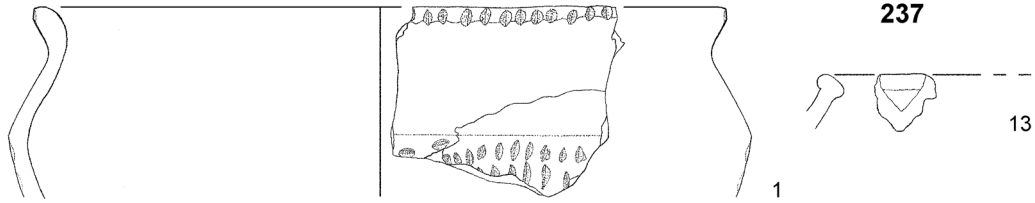

236

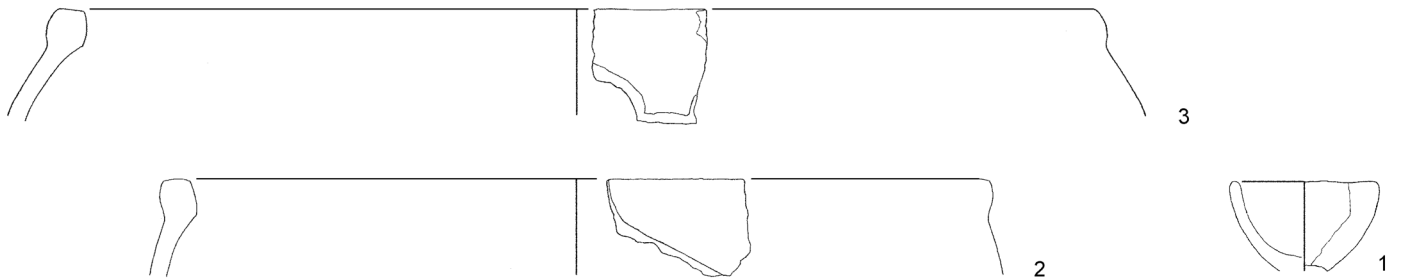

244

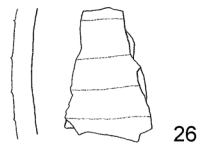

271

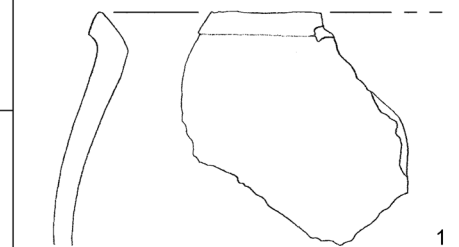

260

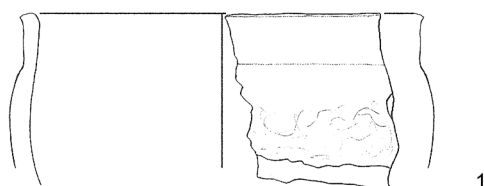

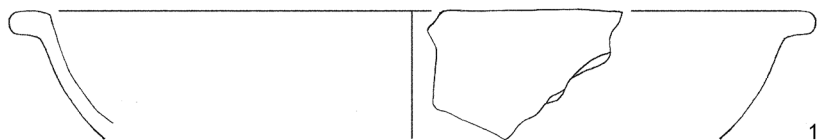

283



2

1

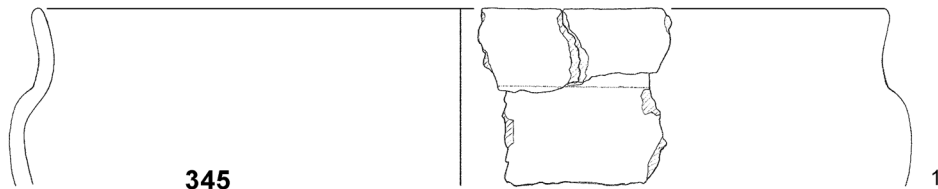

345

1

338



1



305

1

424



1

291



1

340



1

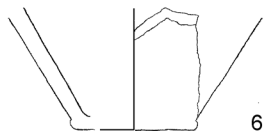

6

442



11

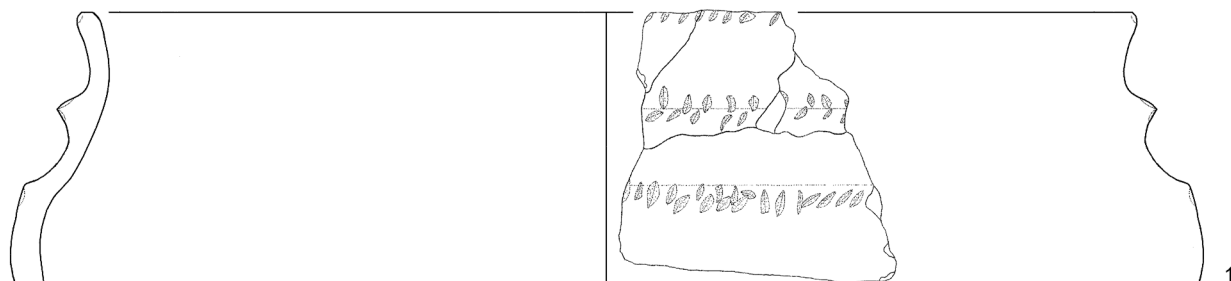

1

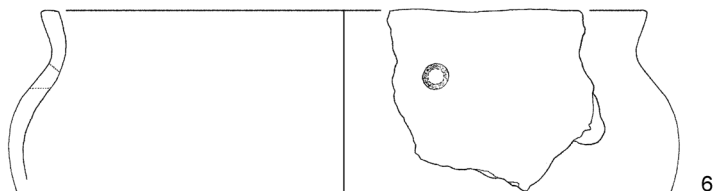

6

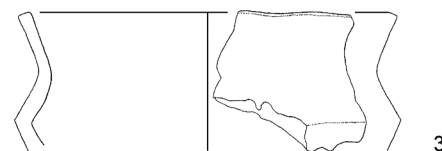

3



4

443

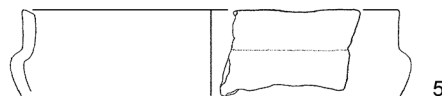

5

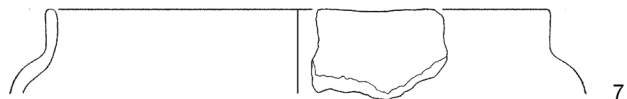

7

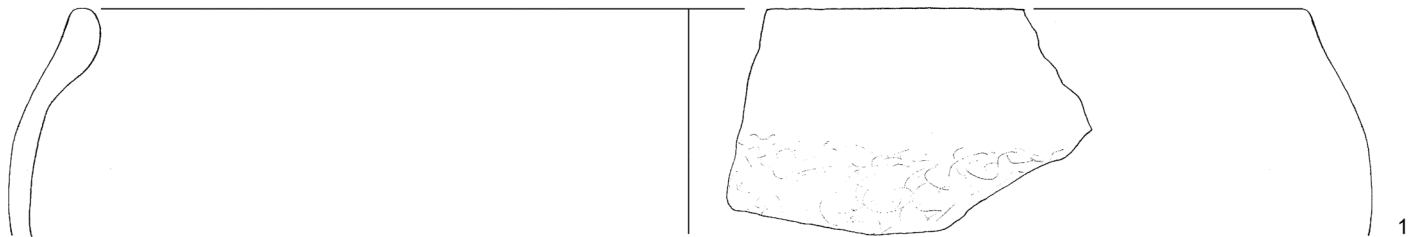
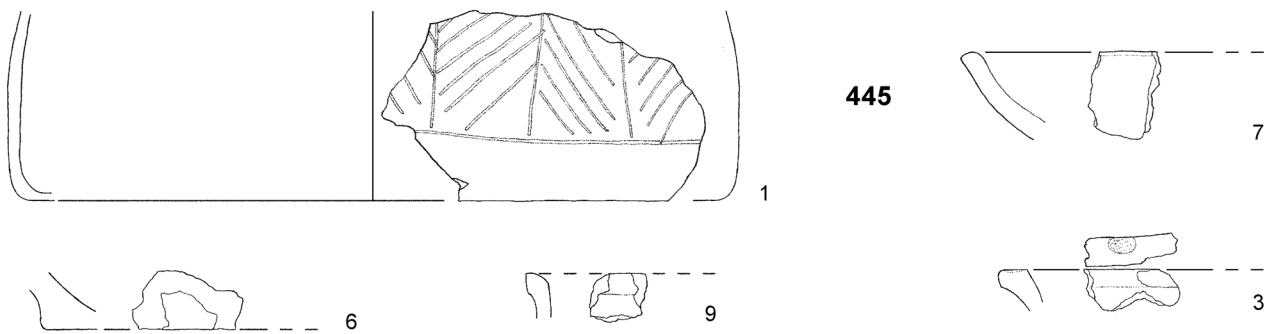
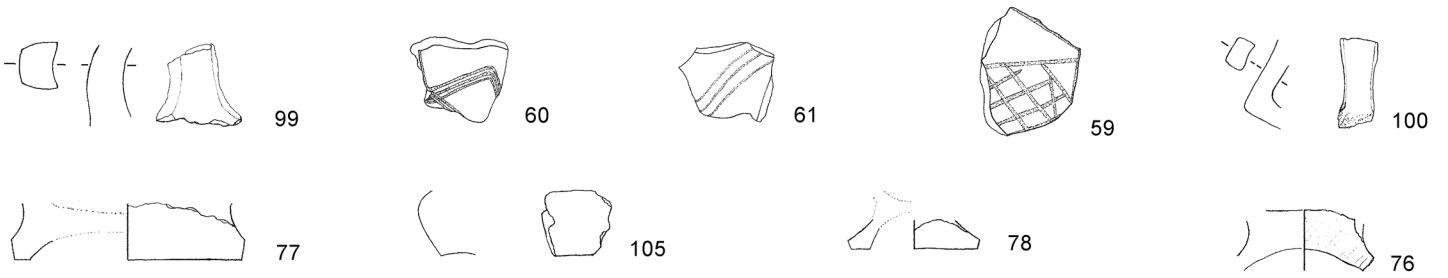
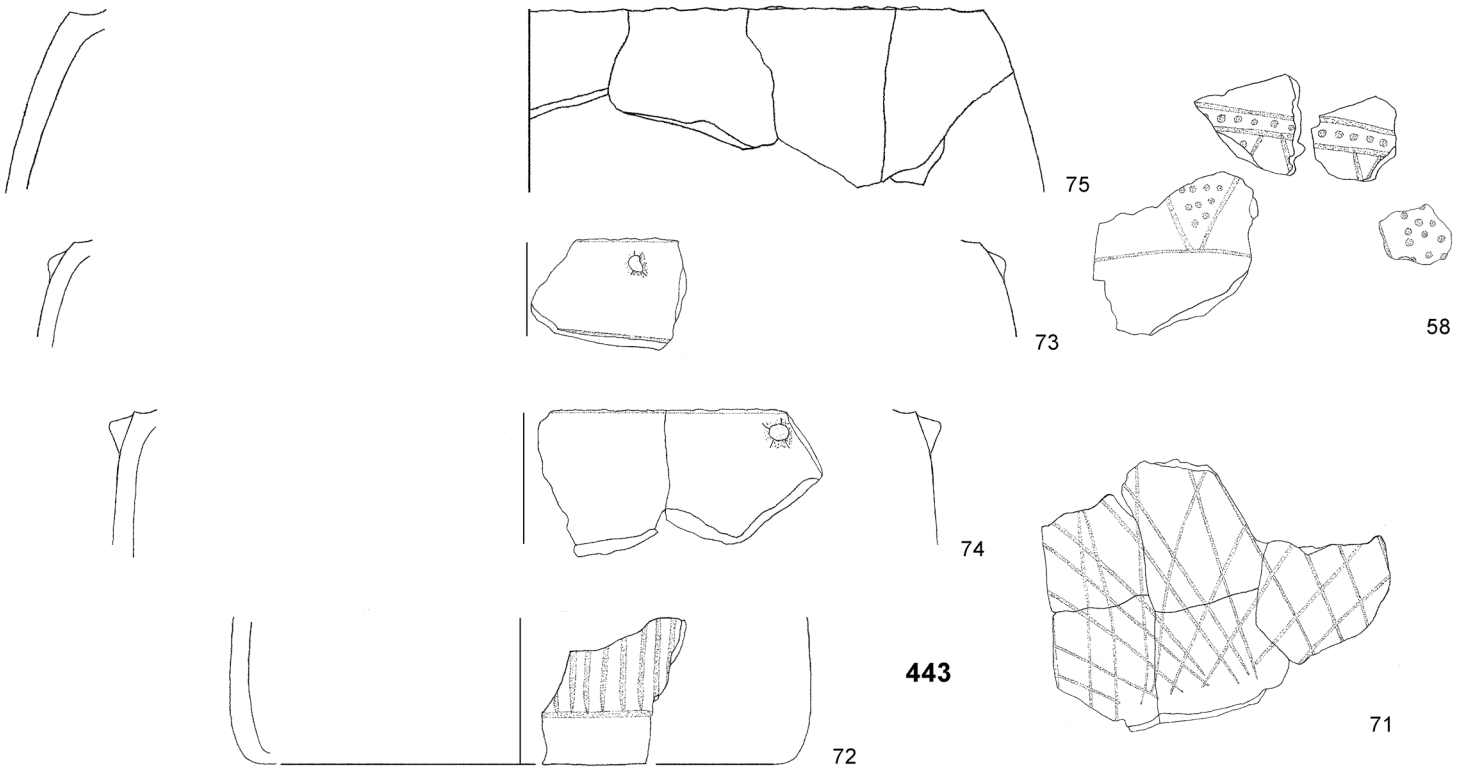

489

499

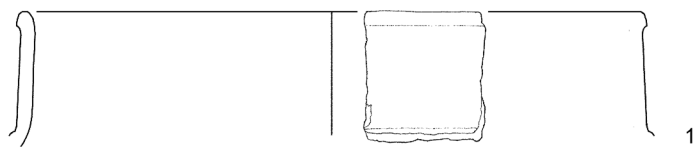

1



1

26

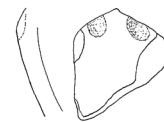

5

34

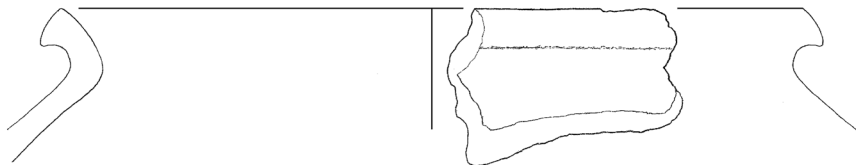

1

67

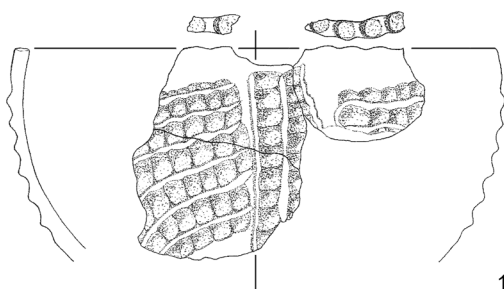

1



24



19

96

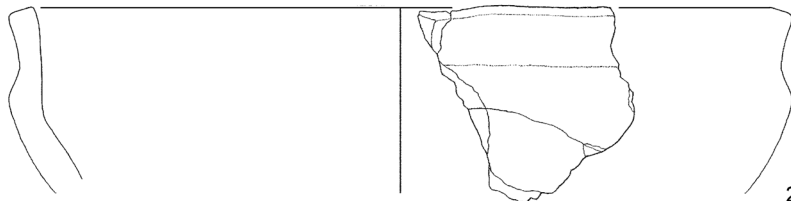

2

72

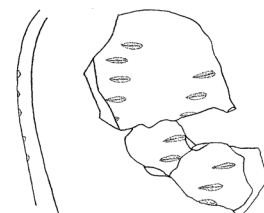

1

95



1



1

104

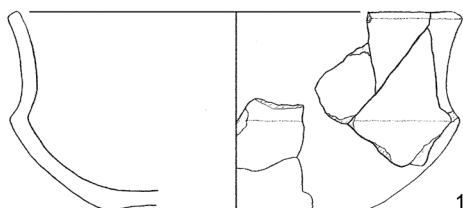

1



6

129



2

130

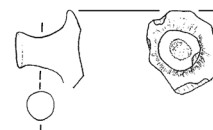

1

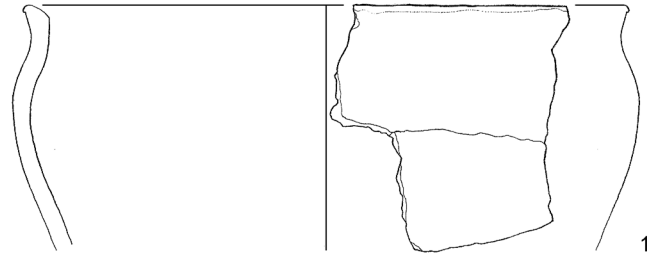
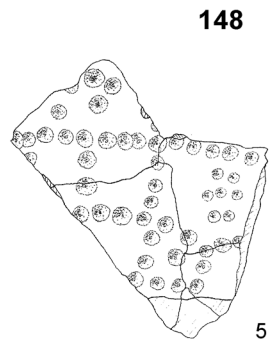
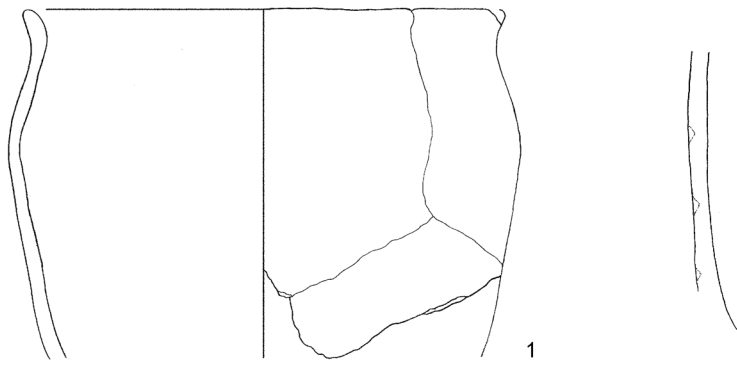

155



158

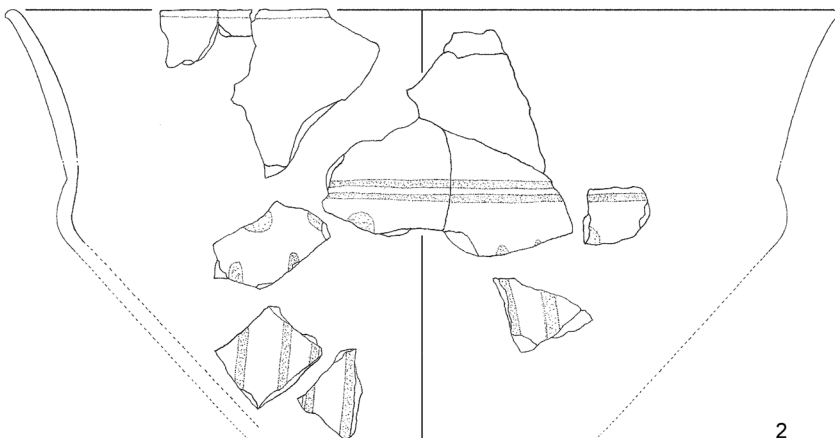
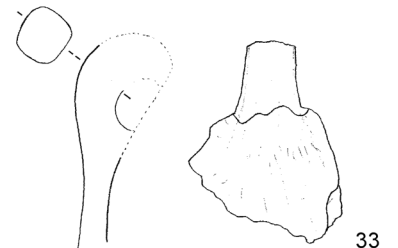
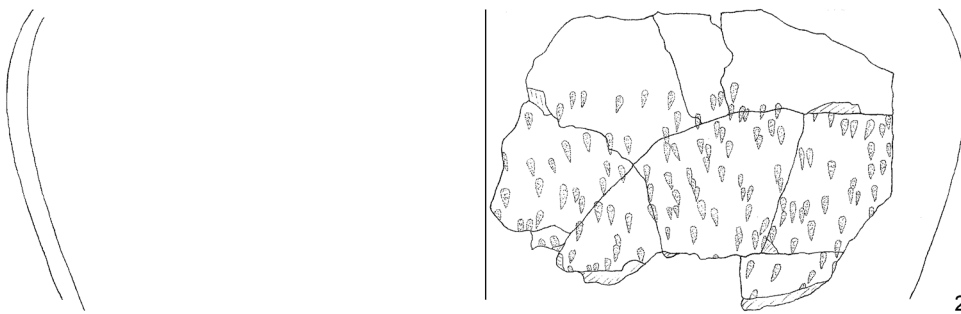
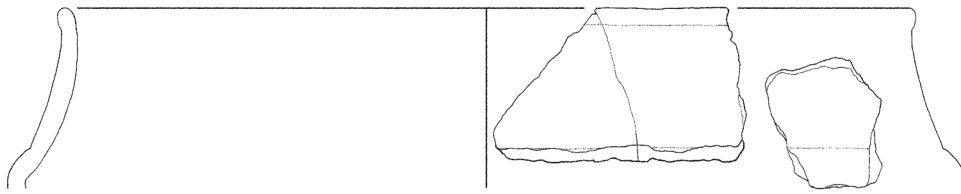
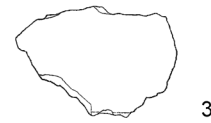

159

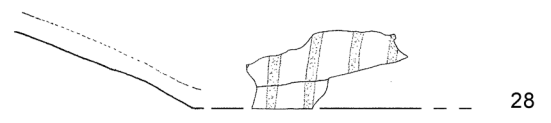

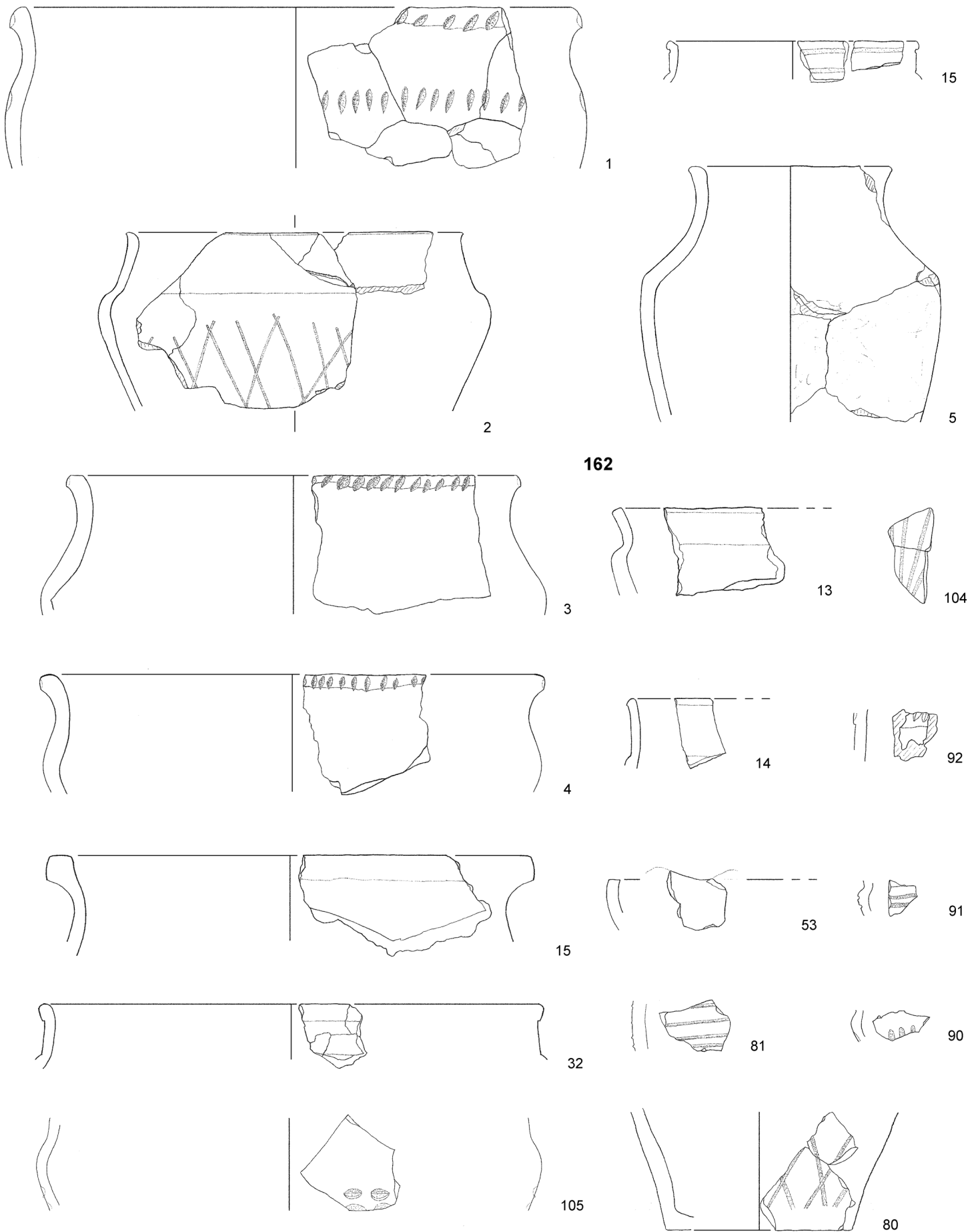

Kirchleimgern, Befund 162 (F.-Nr. 1-105); M 1:3.

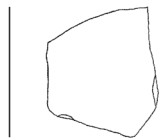

109

162



108



107



106



2

198



1



2

256



1

266

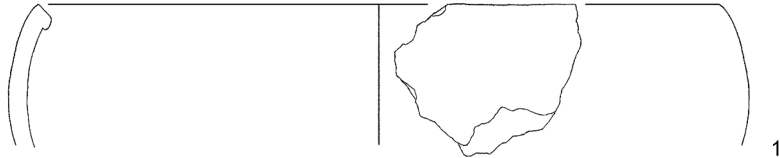

1

260

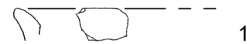

1

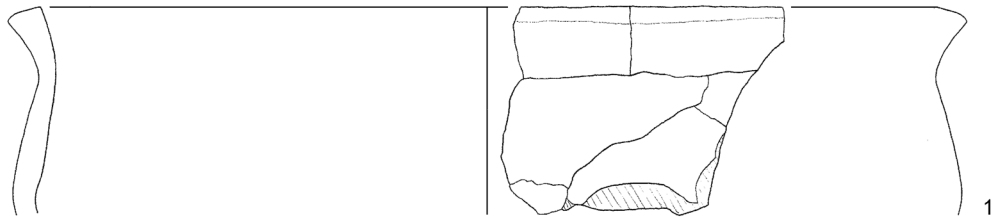

1



4



3

272

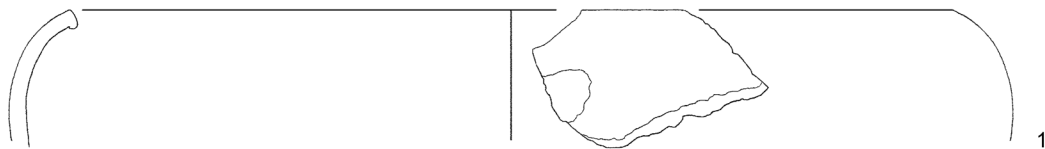

1

275



2

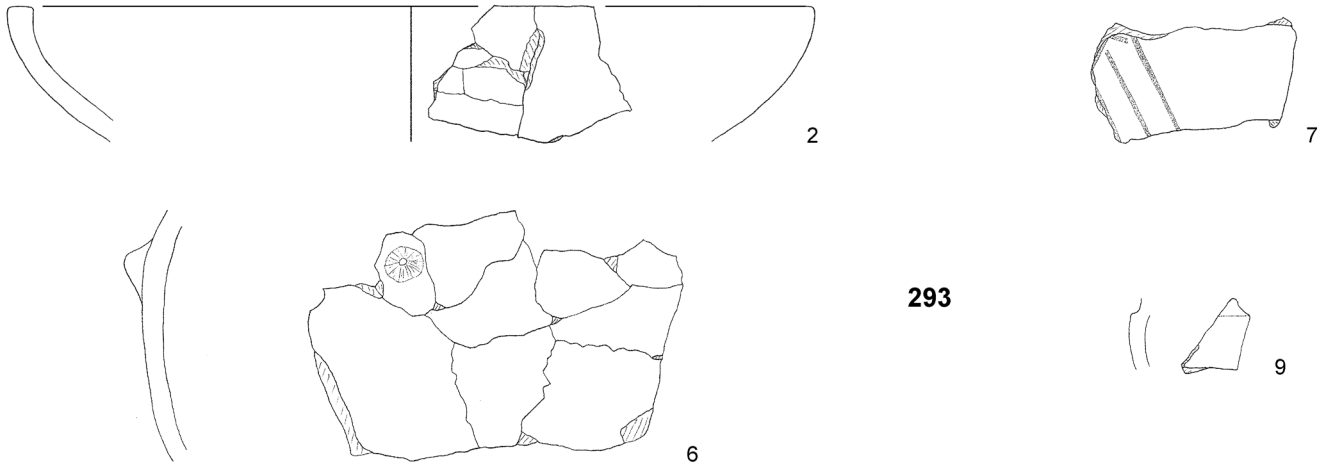

293

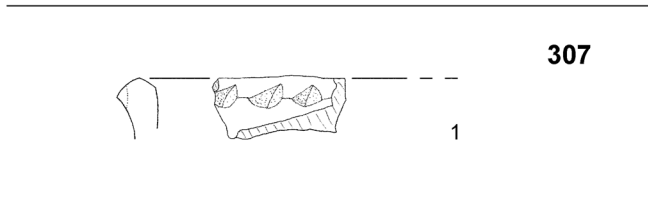

307

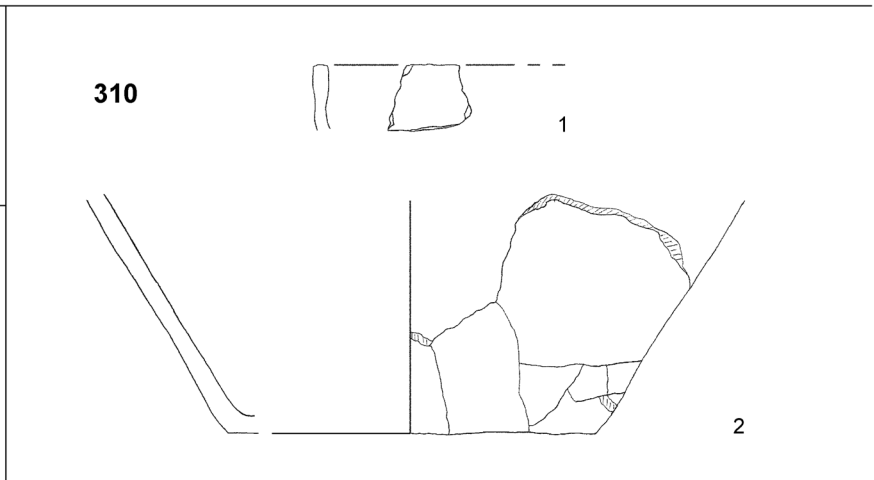

310

312

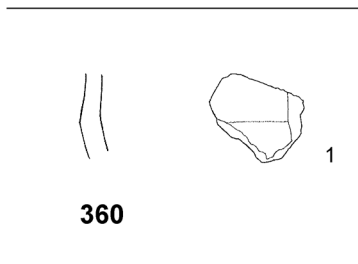

360

377

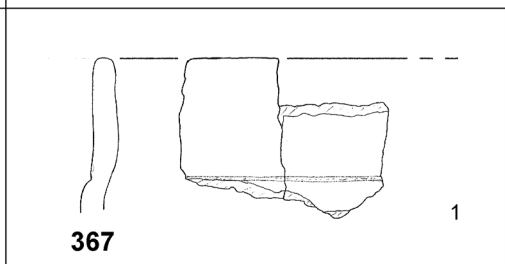

367

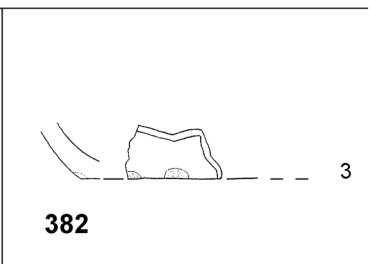

382

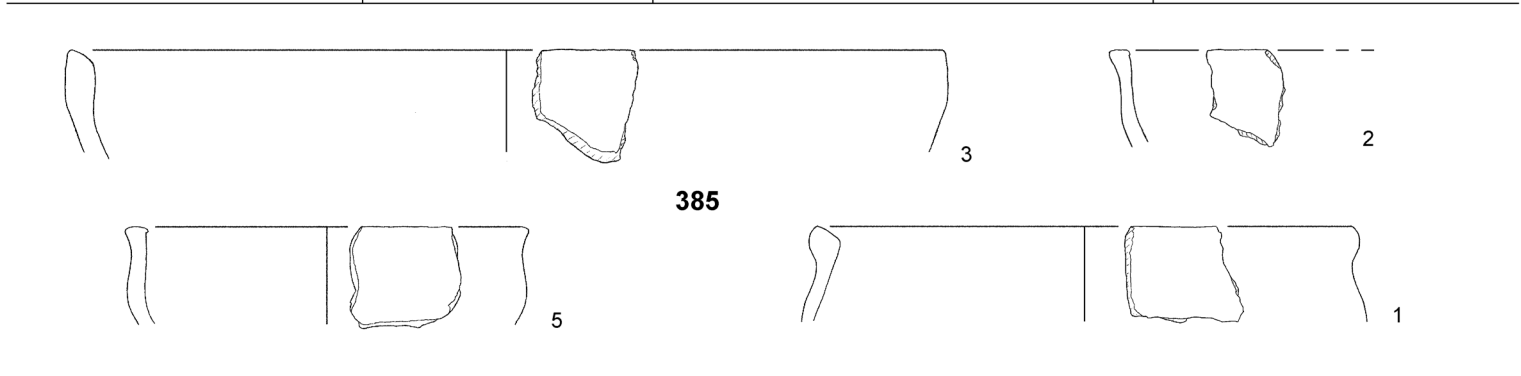

385

392

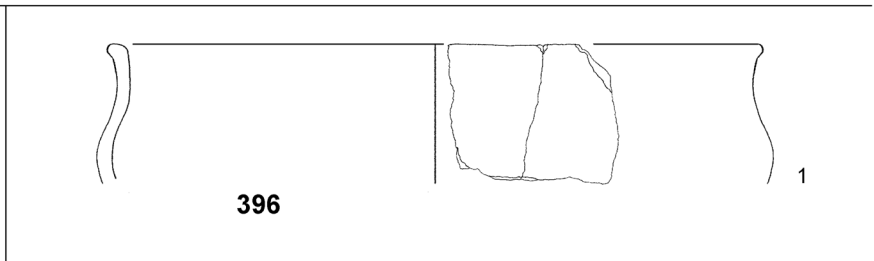

396

Kirchlengern, Befunde 293, 307, 310, 312, 360, 367, 377, 382, 385, 392 und 396; M 1:3.

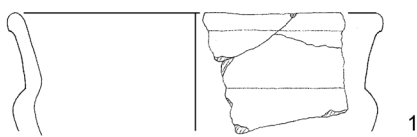
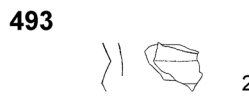
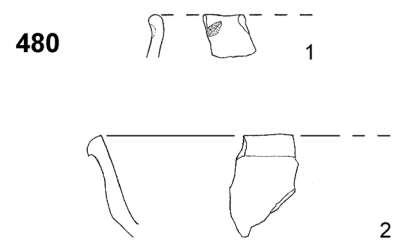
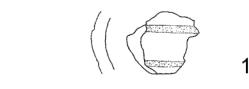
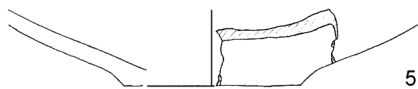
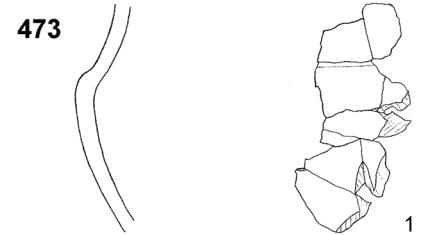
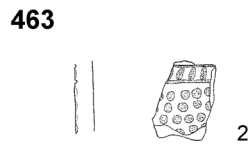
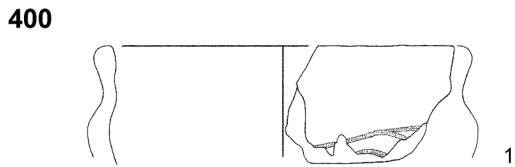
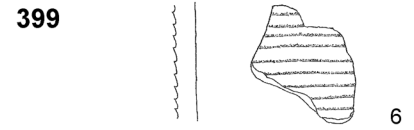
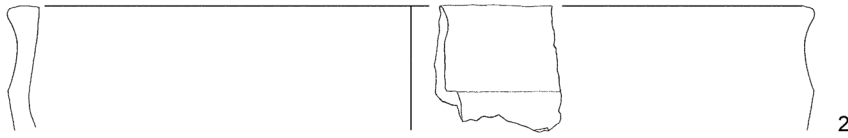
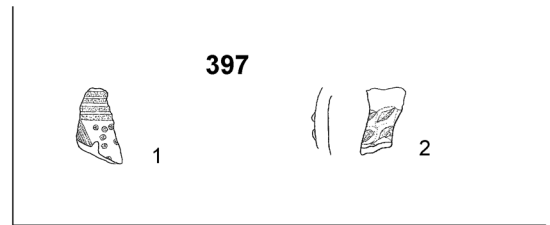
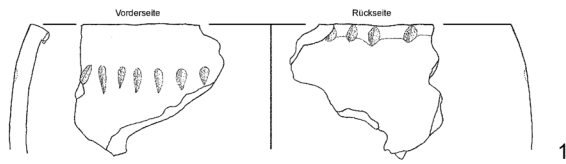

504

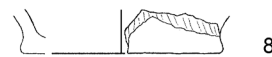

517

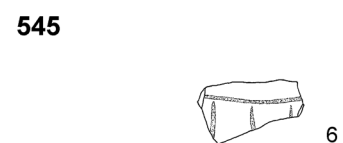
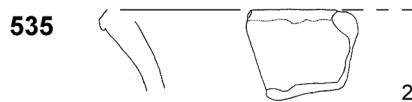

549

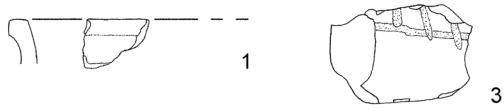

556

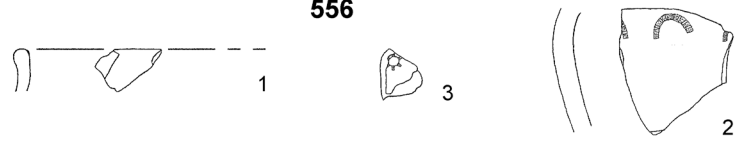

558

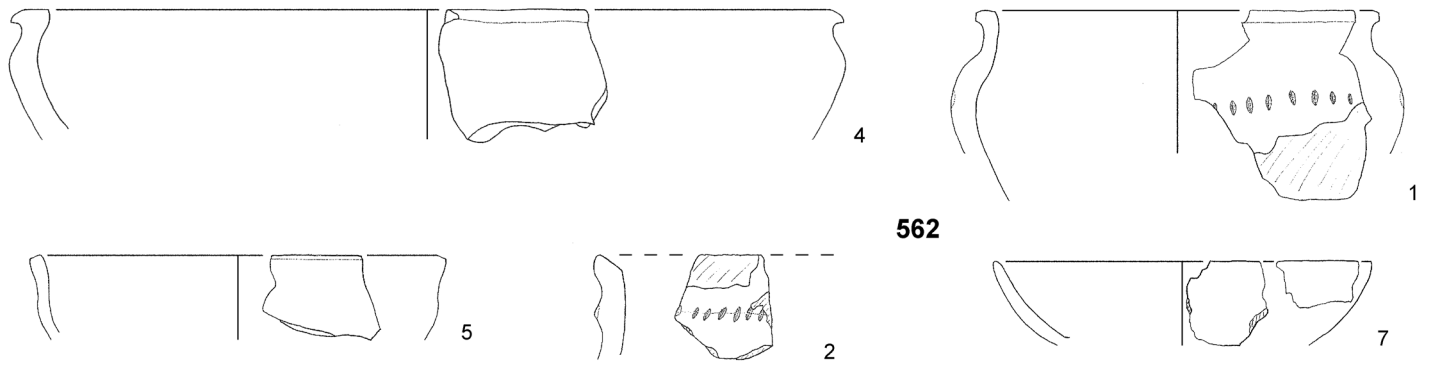
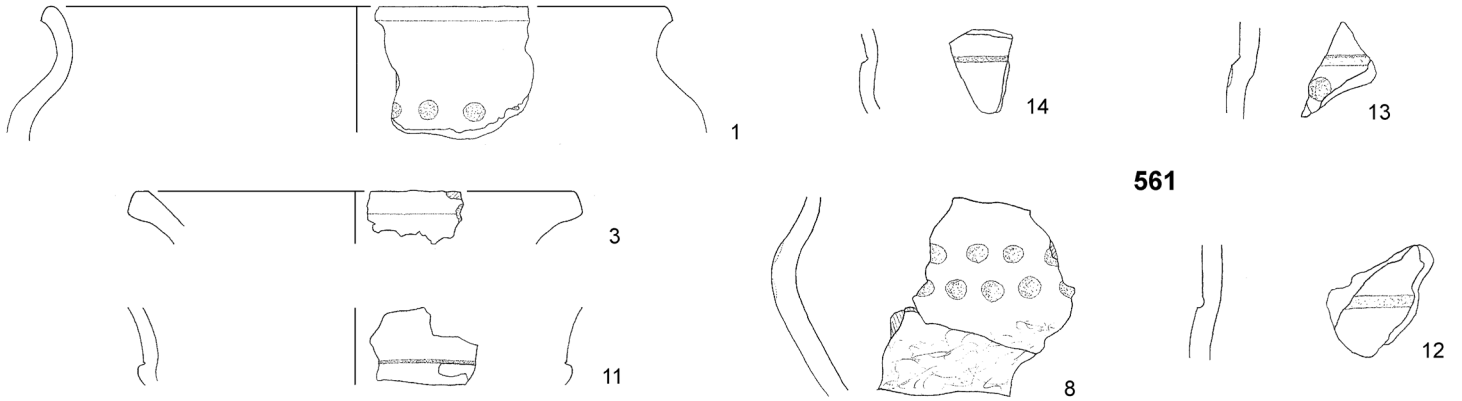
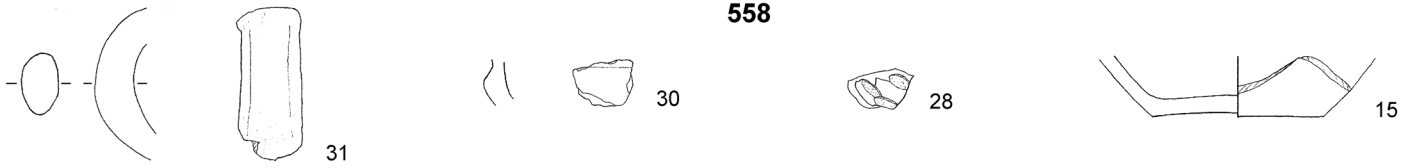

563

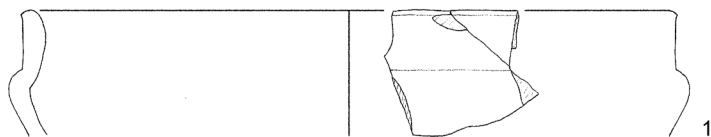

663

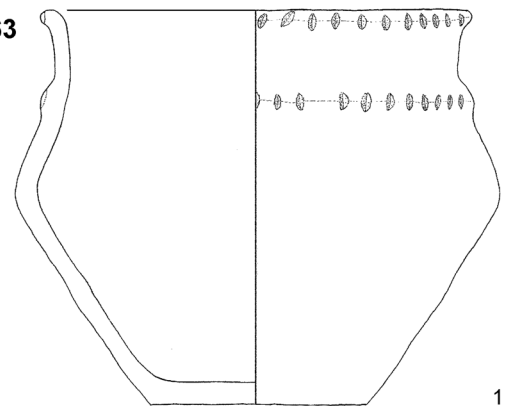

565

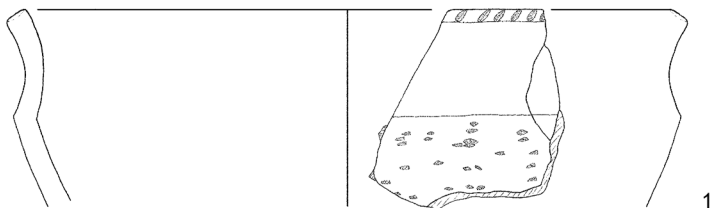

LF

