

SPANTZEICHNUNGEN



Abb. 50a. – Wrack 1. Spanten A 1* bis A 6*. – M. 1:20.



Abb. 50b. – Wrack 1. Spanten A 1* bis A 6*. – M. 1:20.

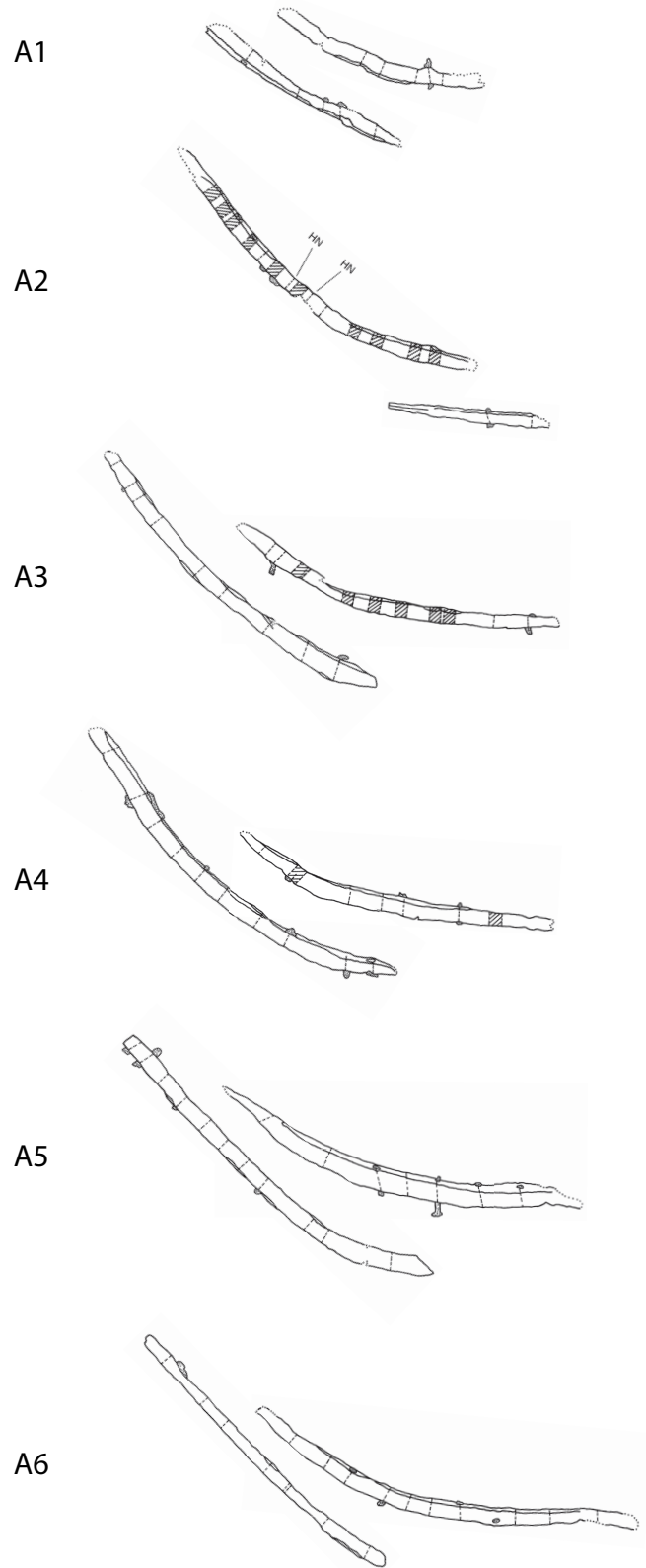
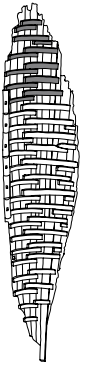

Abb. 51a. – Wrack 1. Spanten A 7* bis A 11*. – M. 1:20.

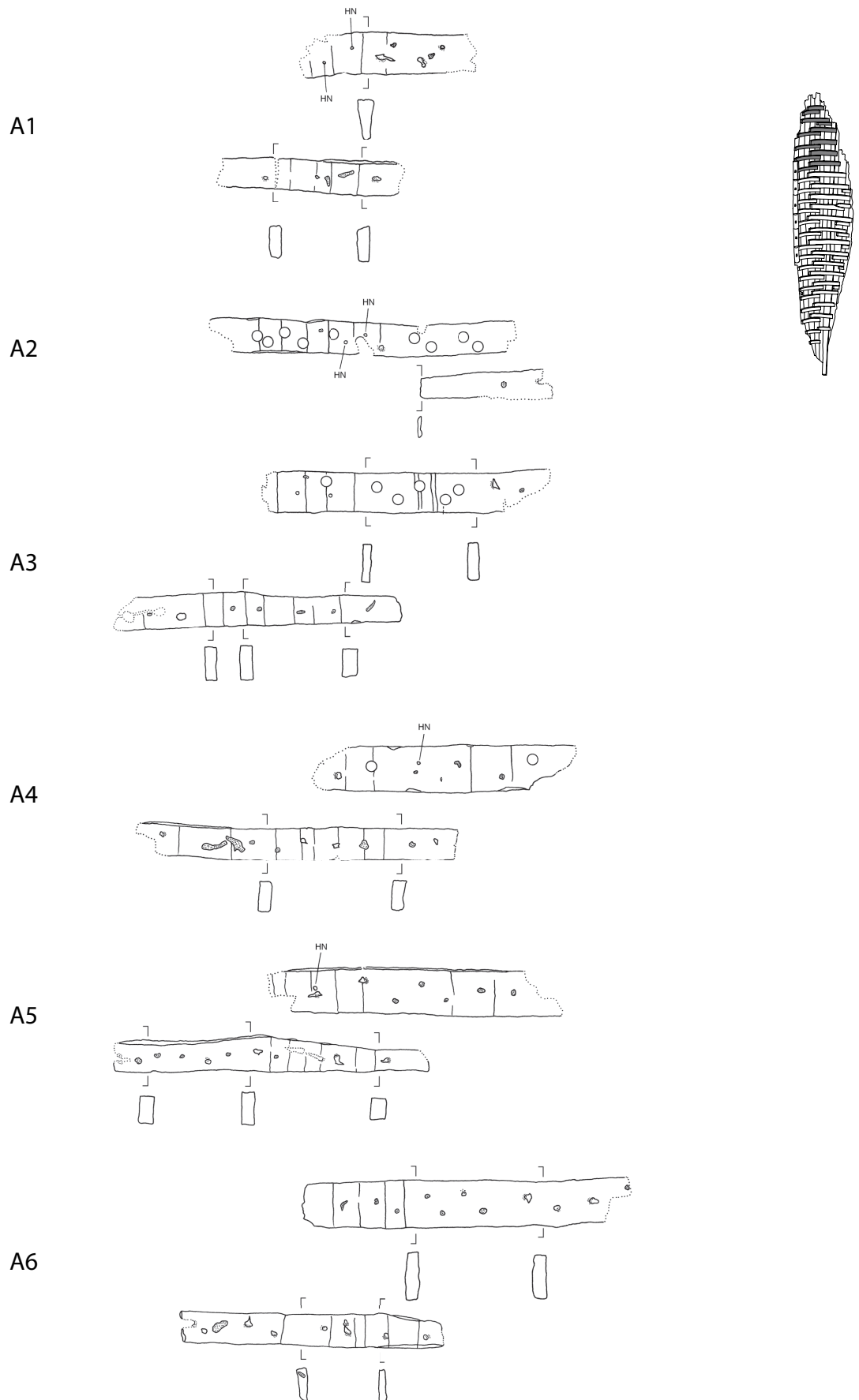

Abb. 51b. – Wrack 1. Spanten A 7* bis A 11*. – M. 1:20.

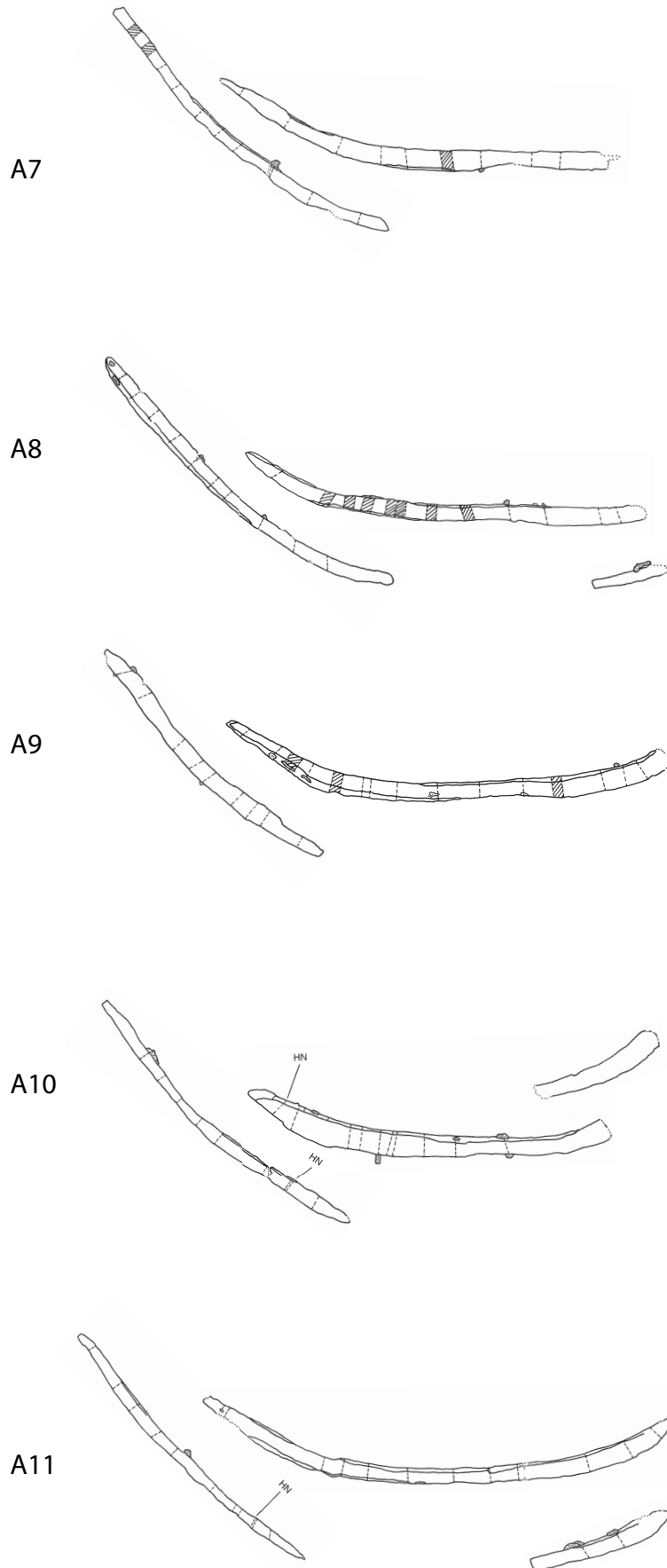
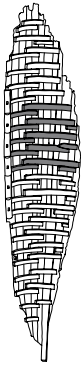

Abb. 52a. – Wrack 1. Spanten A 12* bis A 16*. – M. 1:20.

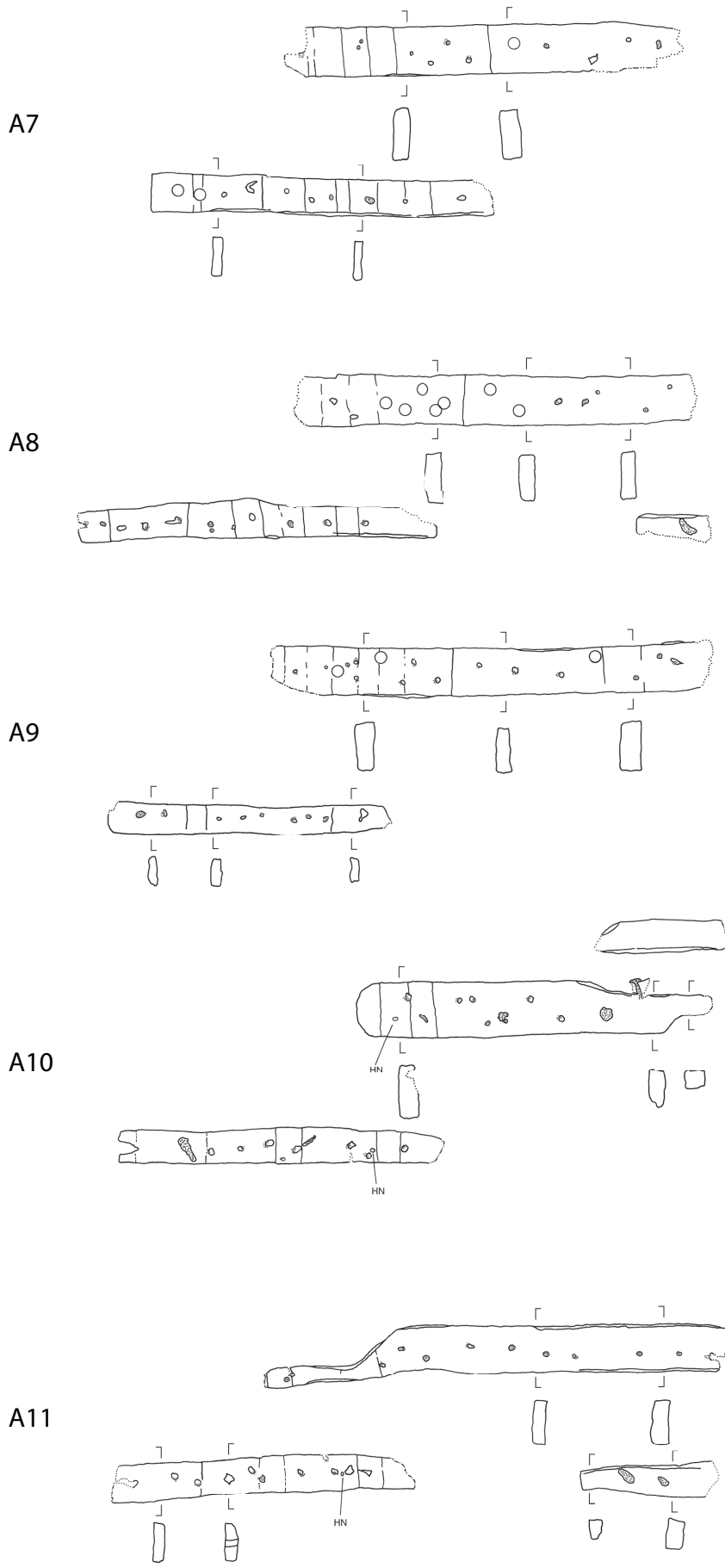

Abb. 52b. – Wrack 1. Spanten A 12* bis A 16*. – M. 1:20.

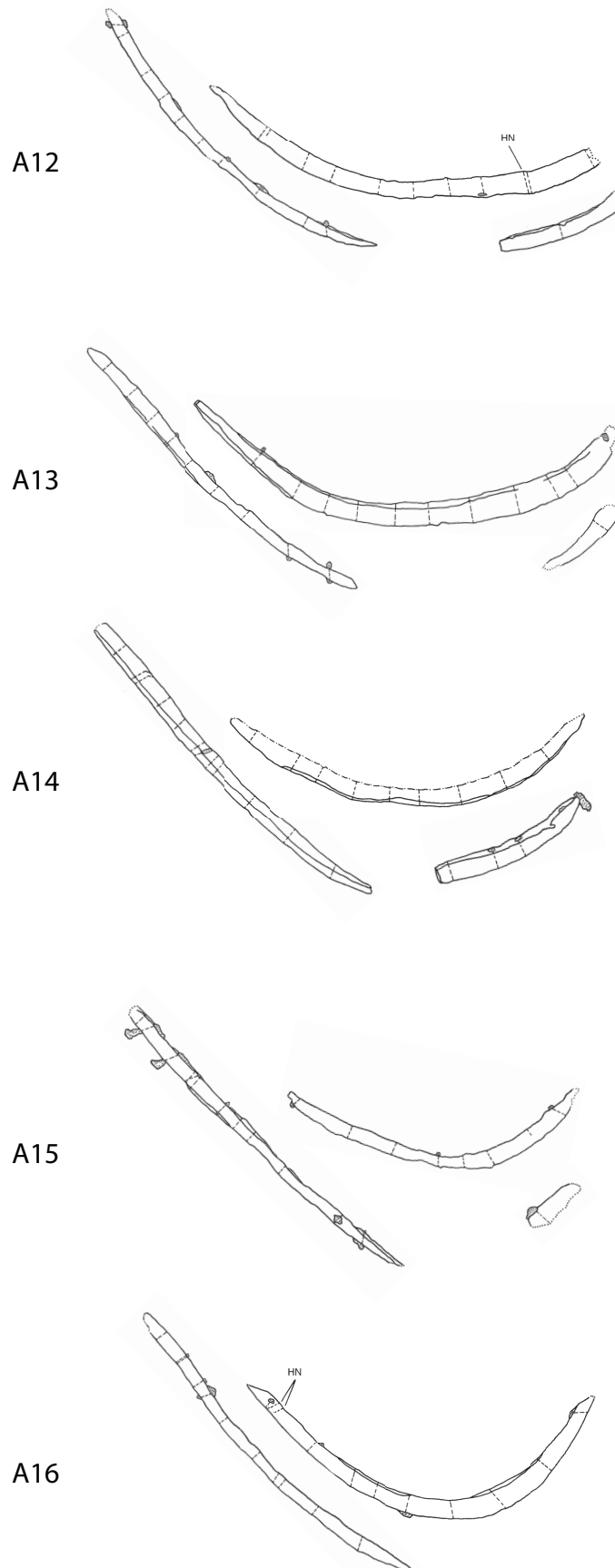
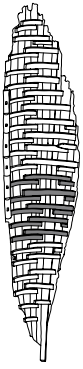

A17

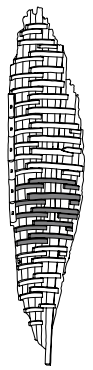
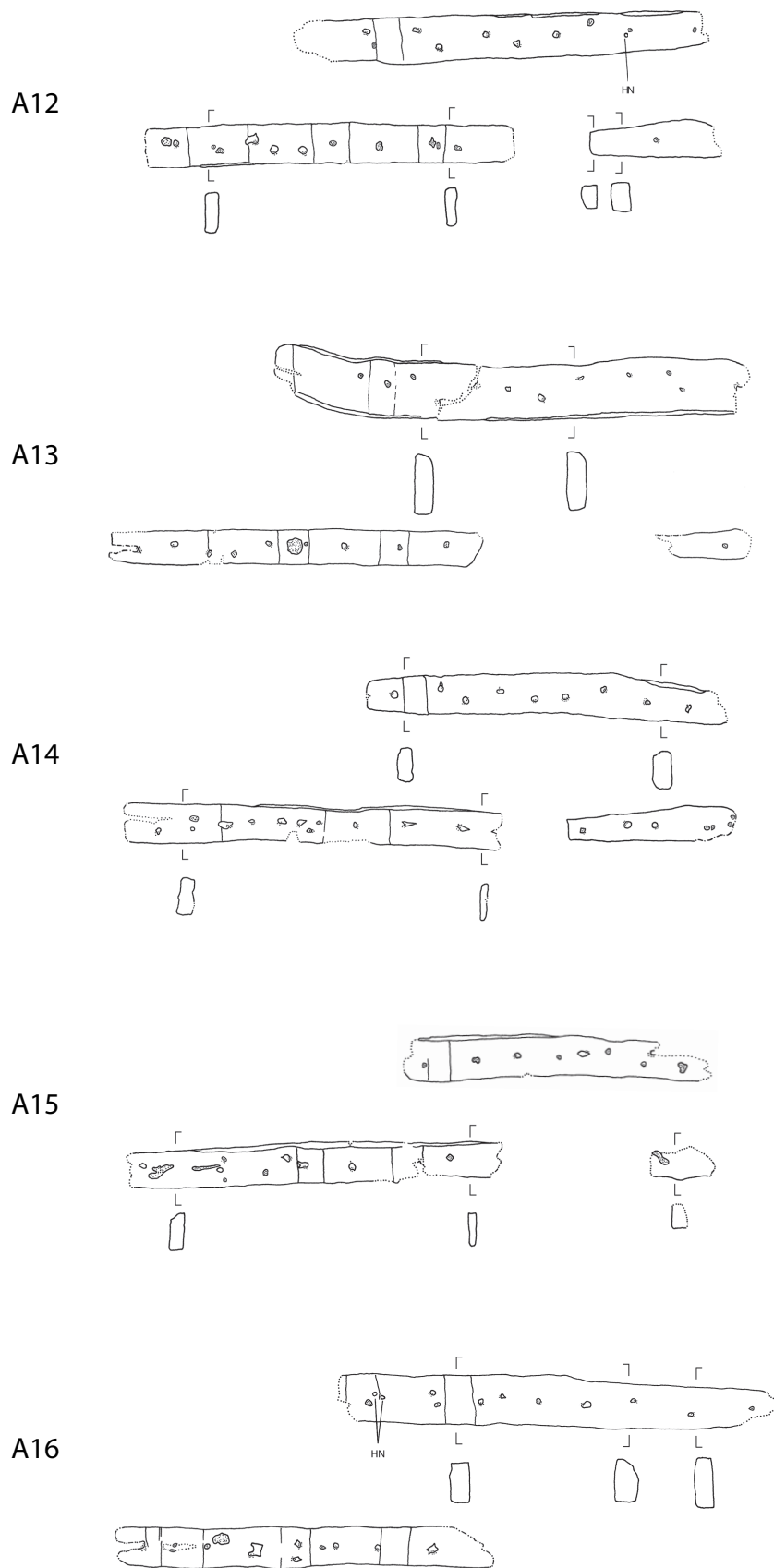
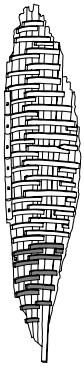
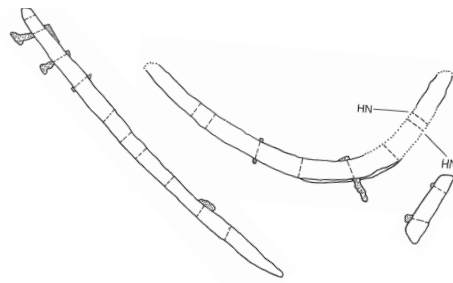

A18

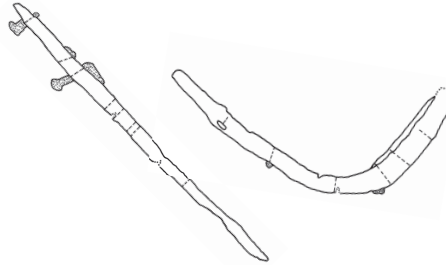

A19

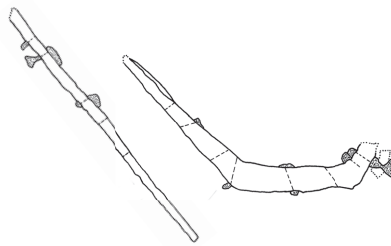

A20

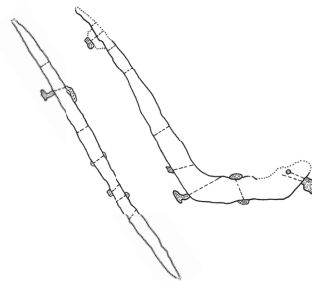

A21

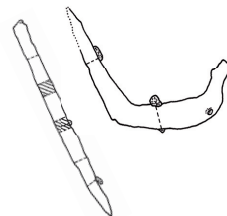

A22



Abb. 53a. – Wrack 1. Spanten A 17* bis A 12*. – M. 1:20.



Abb. 53b. – Wrack 1. Spanten A 17* bis A 12*. – M. 1:20.



A2

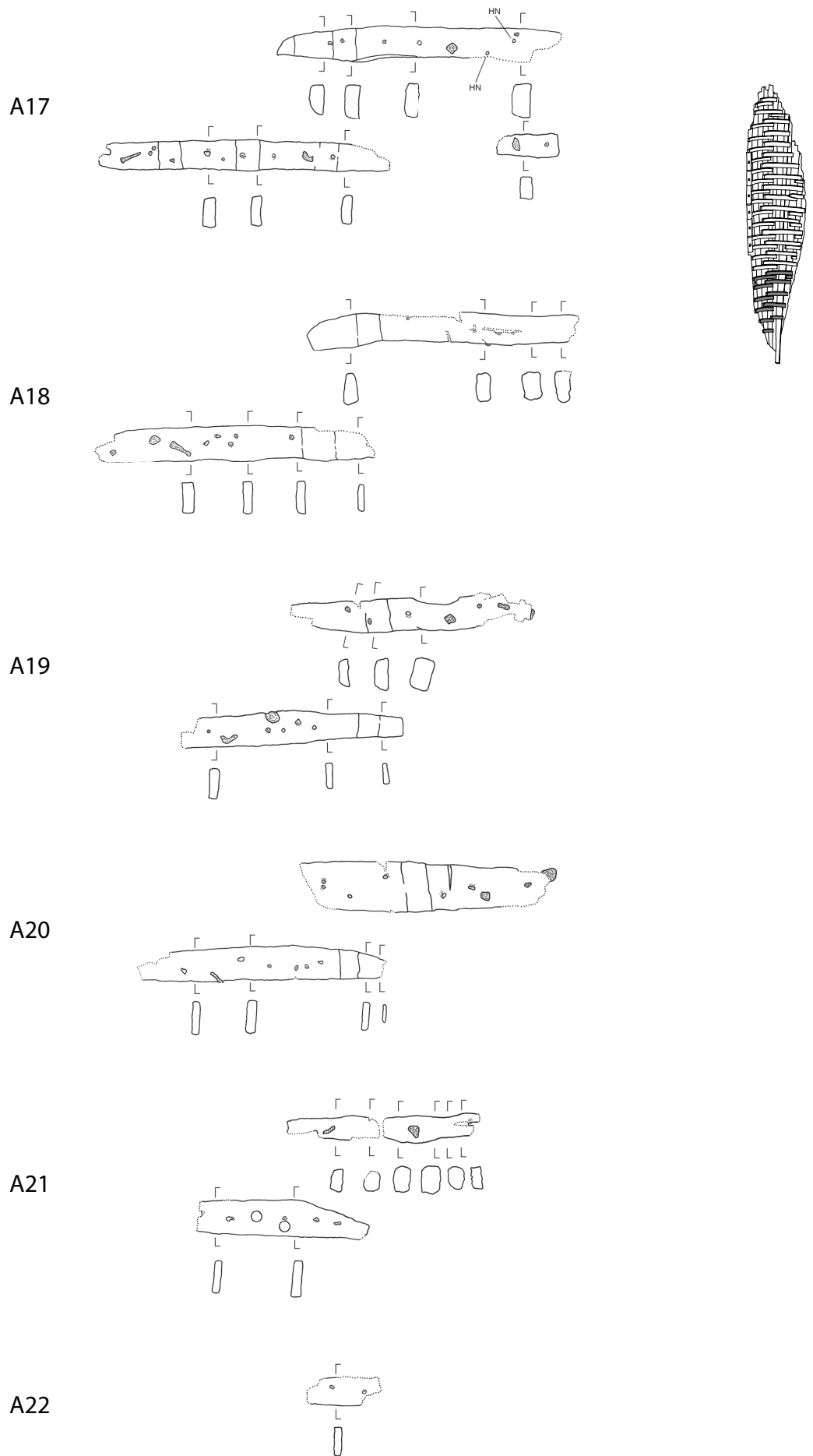
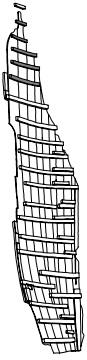
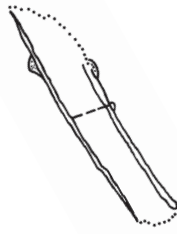

A3

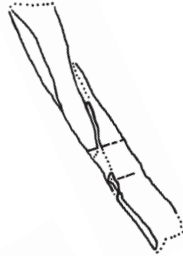

A4

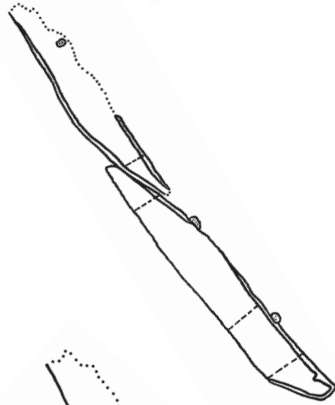

A5

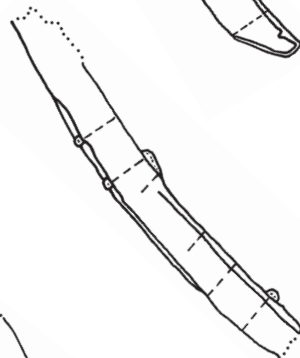

A6



Abb. 54a. – Wrack 2. Spanten A 2* bis A 6*. – M. 1:10.

A2



A3

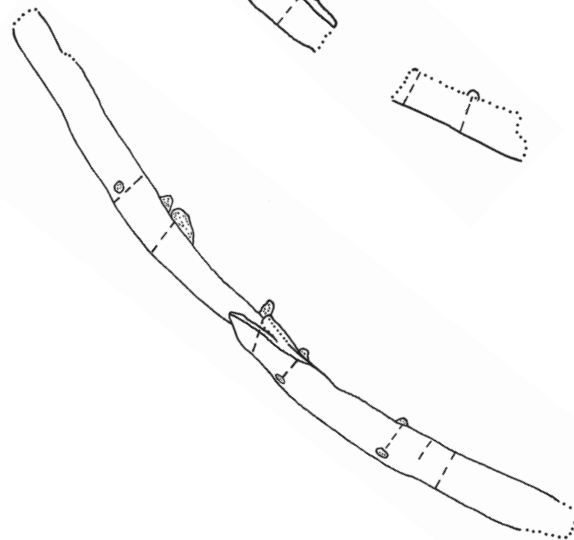
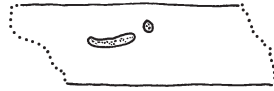
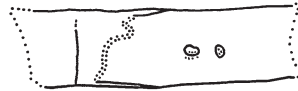

A4



A5



A6



Abb. 54b. – Wrack 2. Spanten A 2* bis A 6*. – M. 1:10.



A7

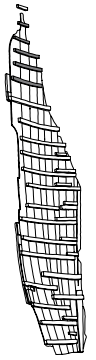
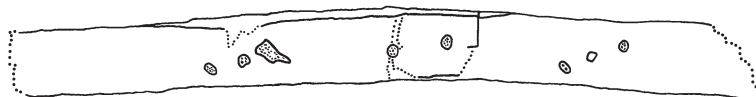
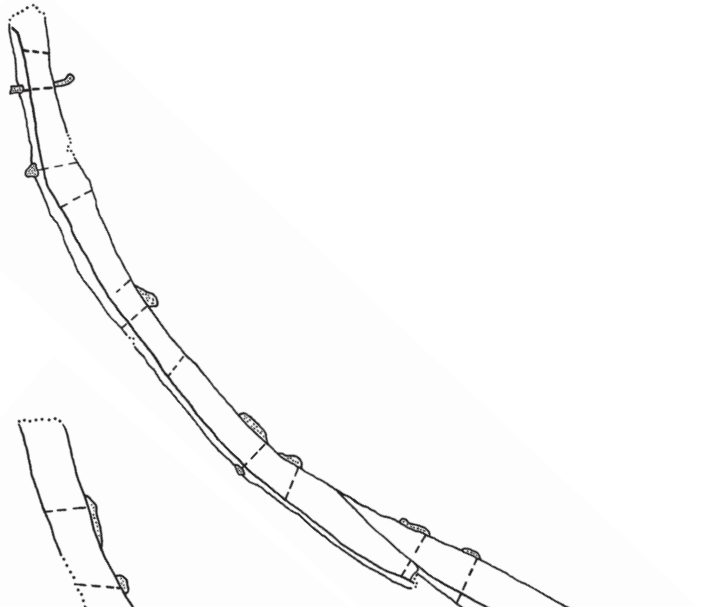

A8

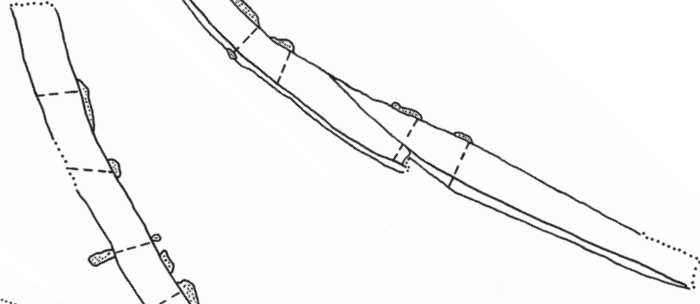

A9

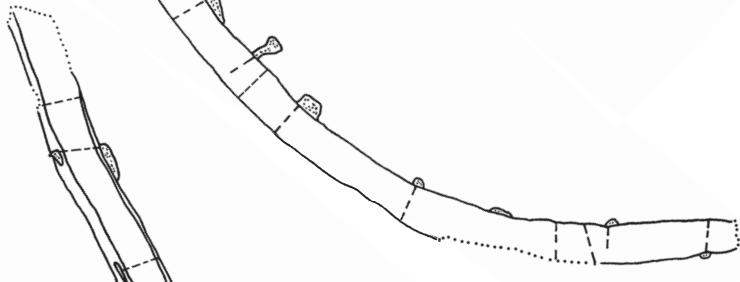

A10

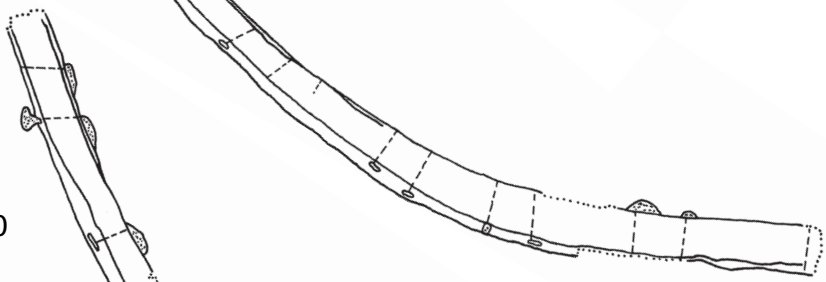

A11



Abb. 55a. – Wrack 2. Spanten A 7* bis A 11*. – M. 1:10.



Abb. 55b. – Wrack 2. Spanten A 7* bis A 11*. – M. 1:10.

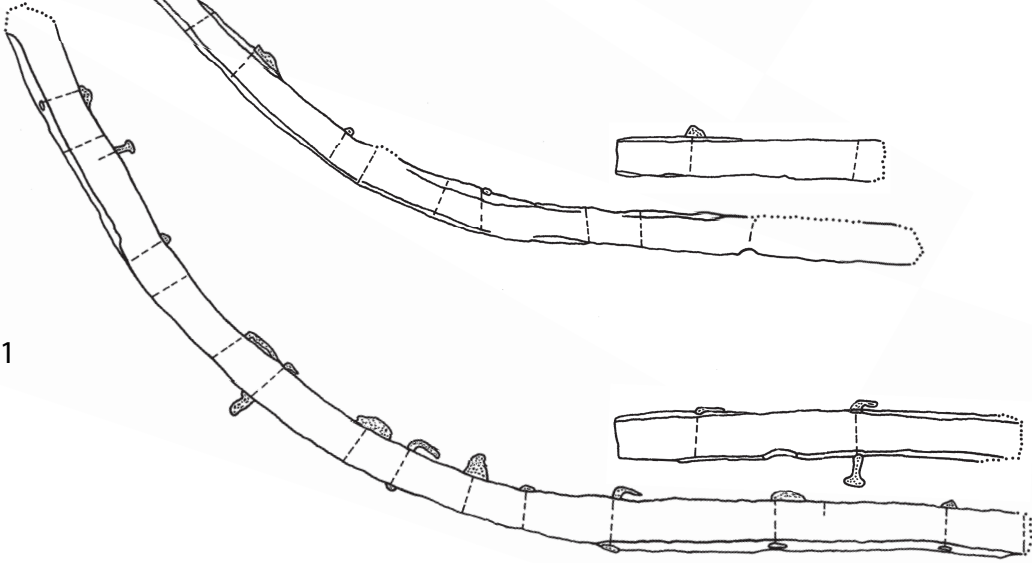

Abb. 56a. – Wrack 2. Spanten A 12* bis A 15*. – M. 1:10.

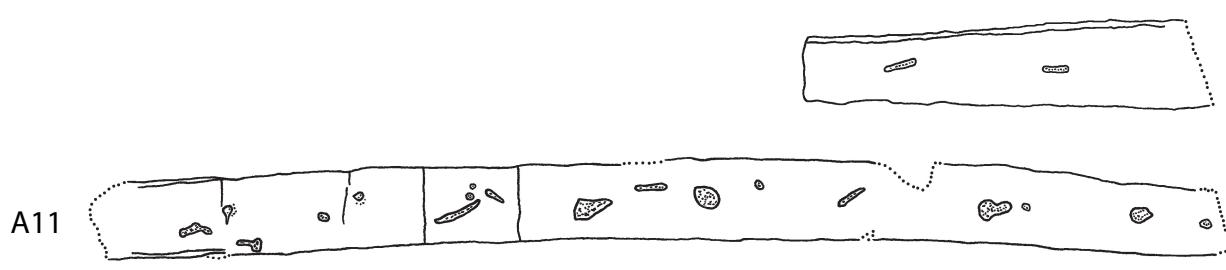
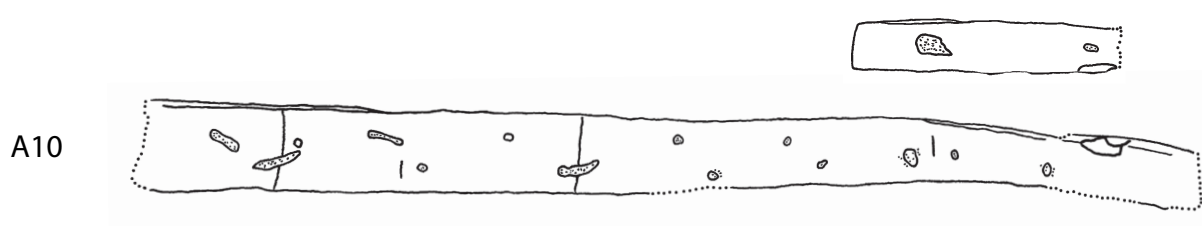
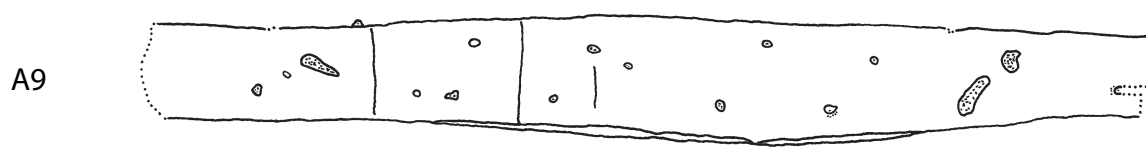
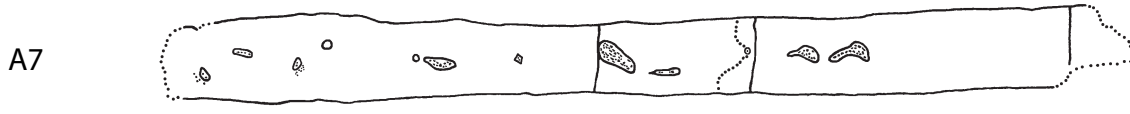

A12

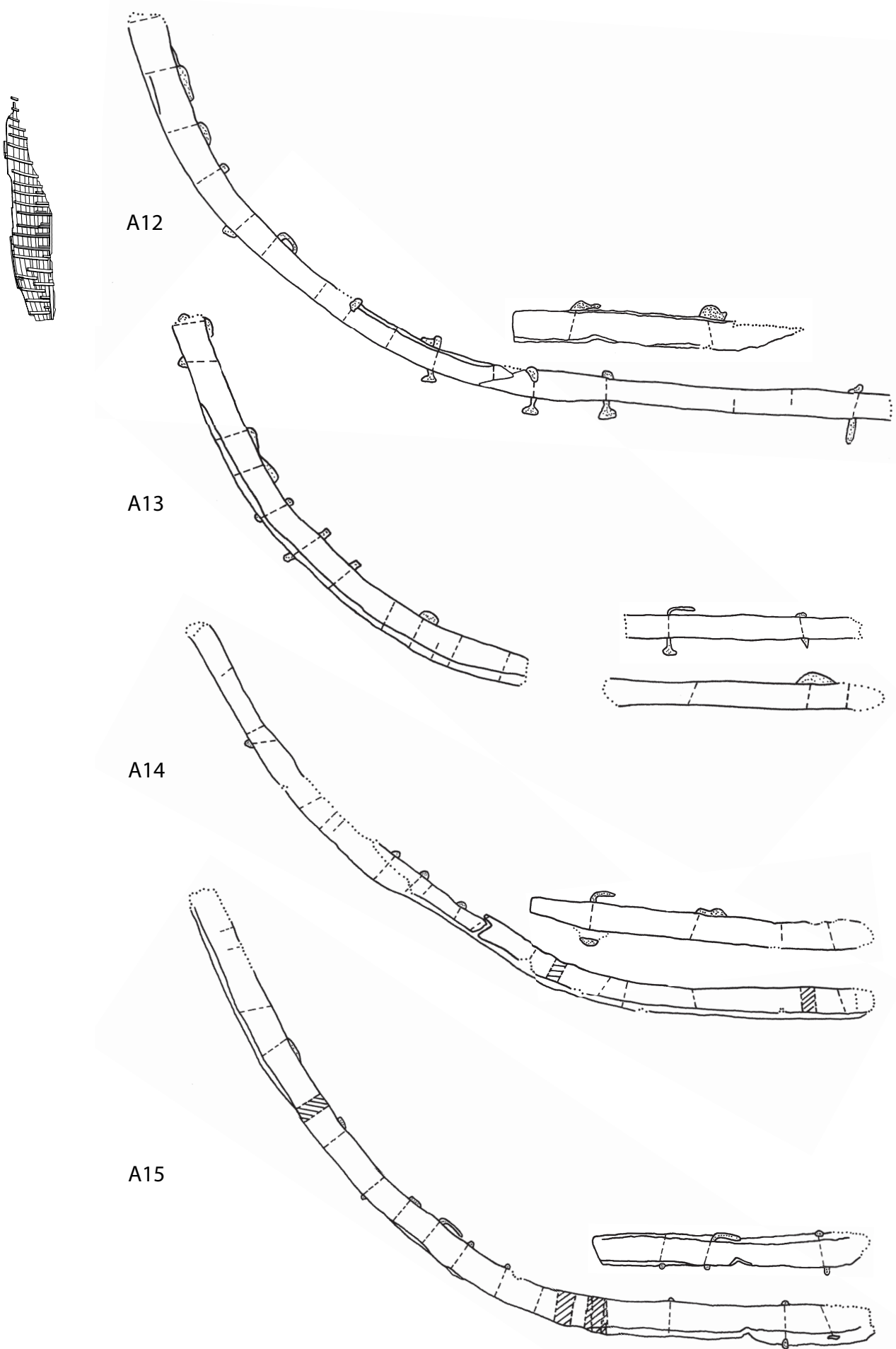
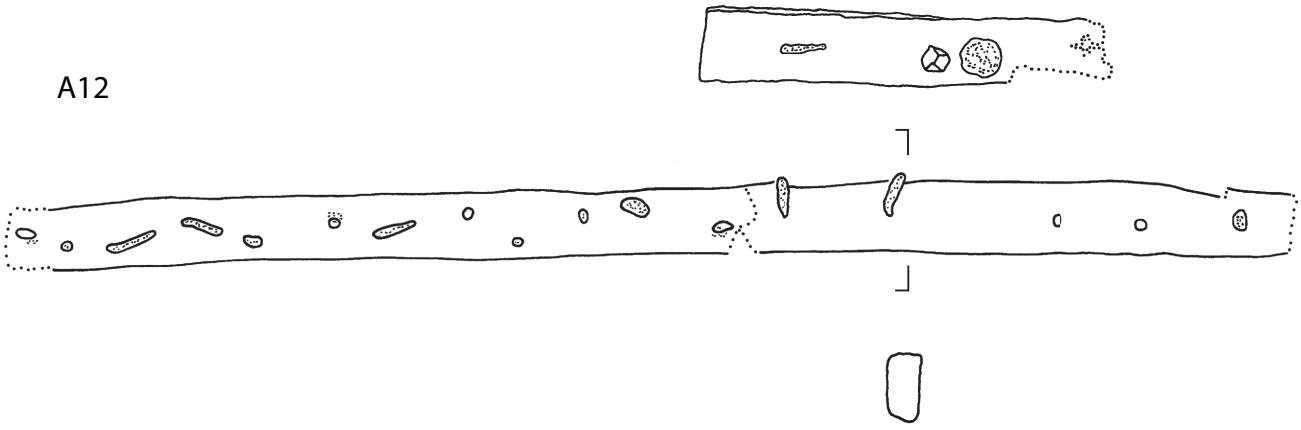

A13

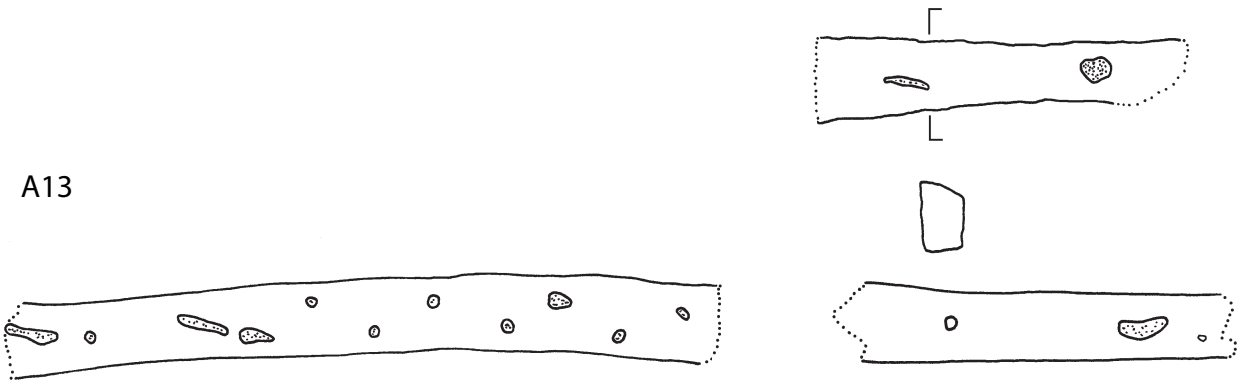

A14

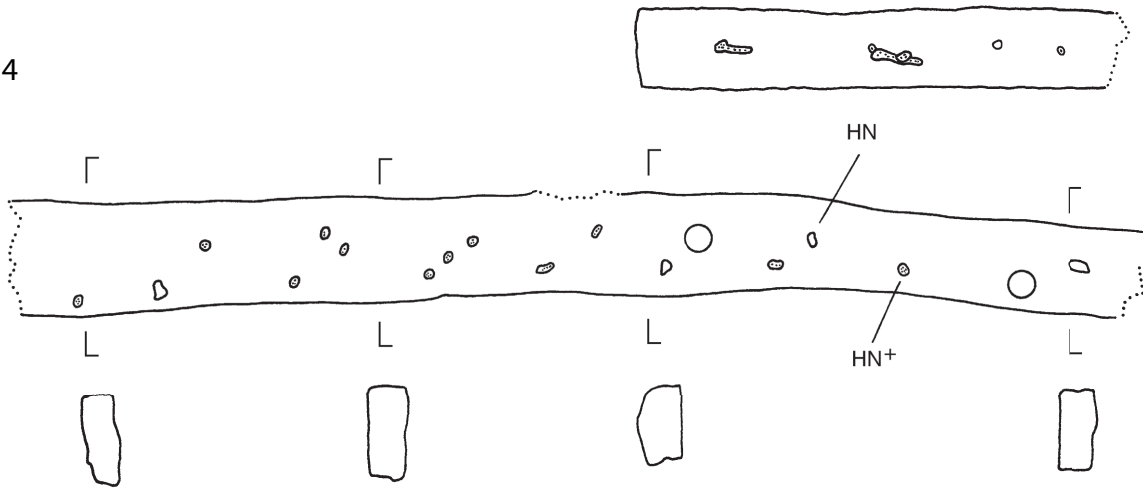

A15



Abb. 56b. – Wrack 2. Spanten A 12* bis A 15*. – M. 1:10.



Abb. 57a. – Wrack 2. Spanten A 16* bis A 19*. – M. 1:10.

A16

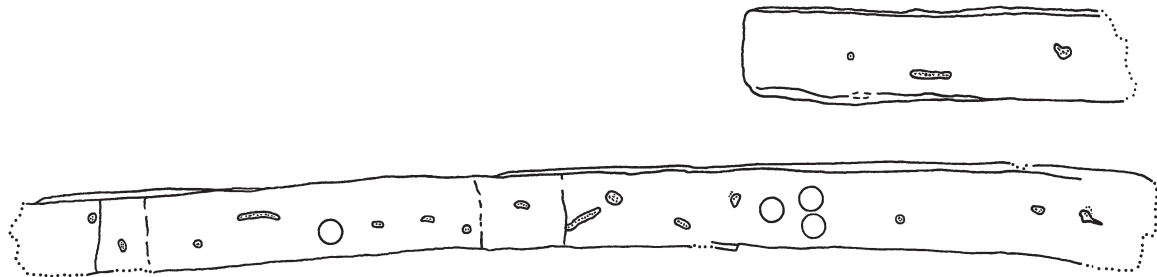

A17

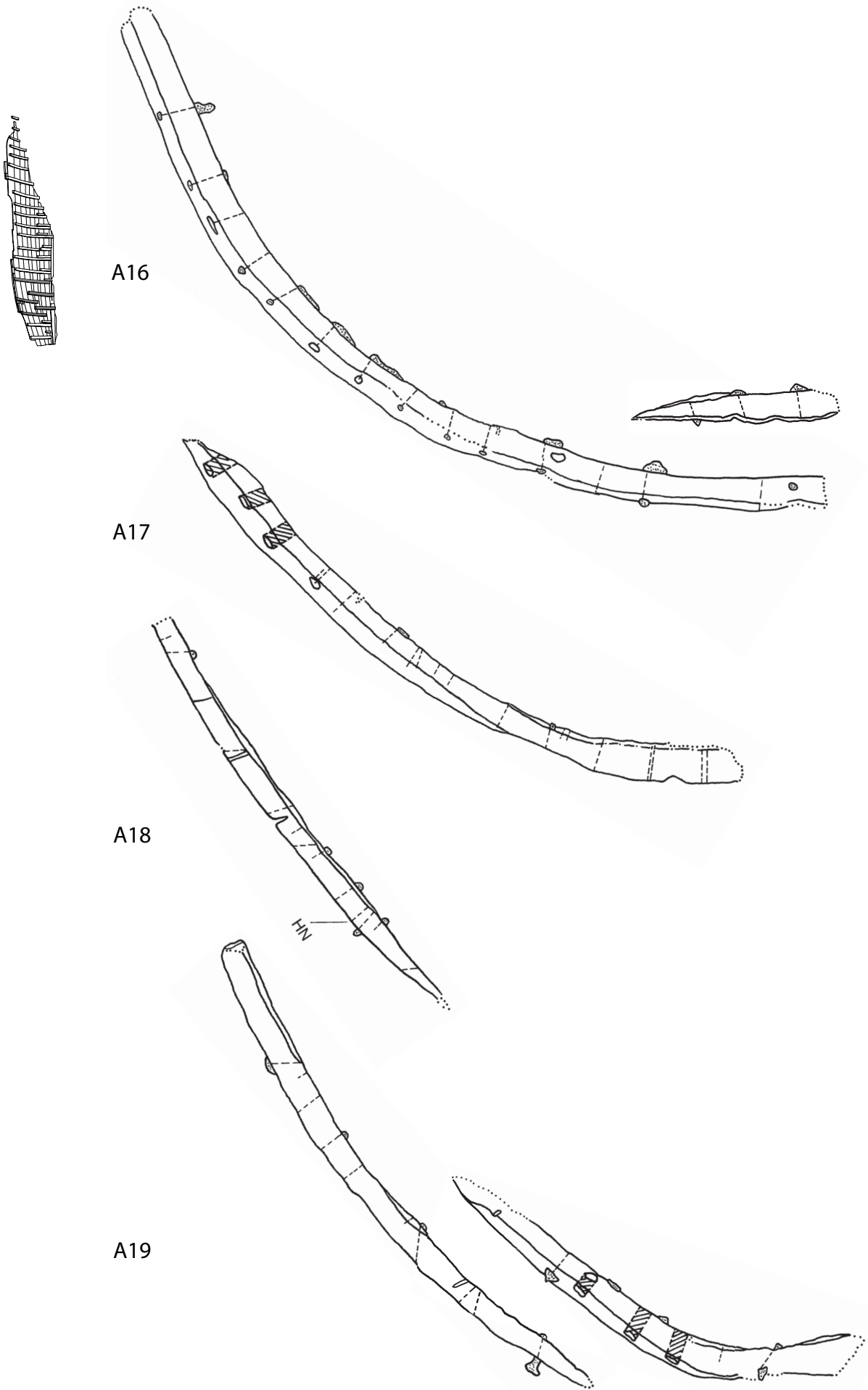
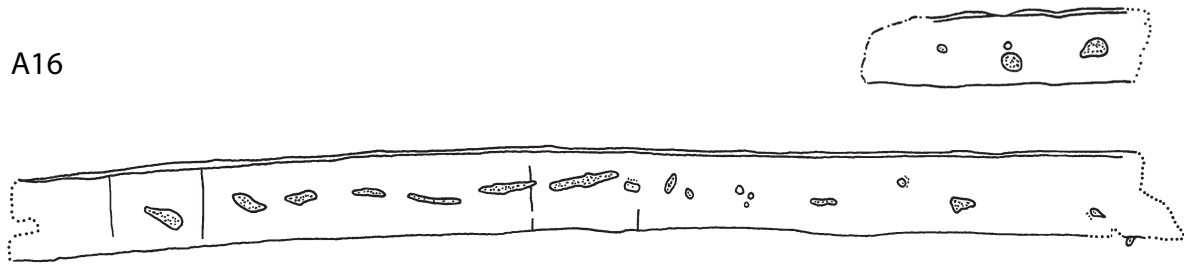
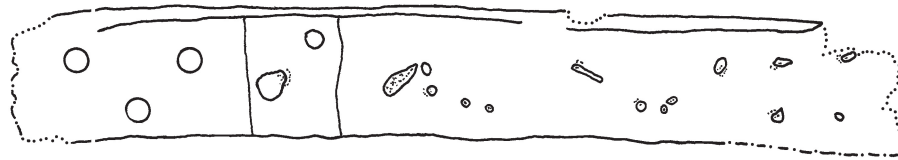

A18

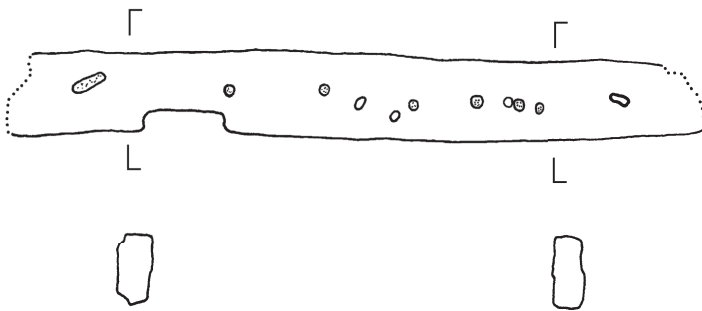

A19



Abb. 57b. – Wrack 2. Spanten A 16* bis A 19*. – M. 1:10.



A20

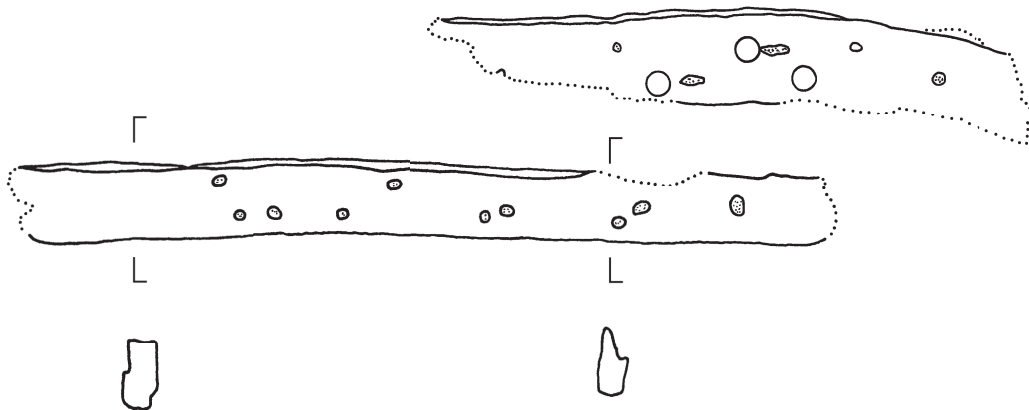
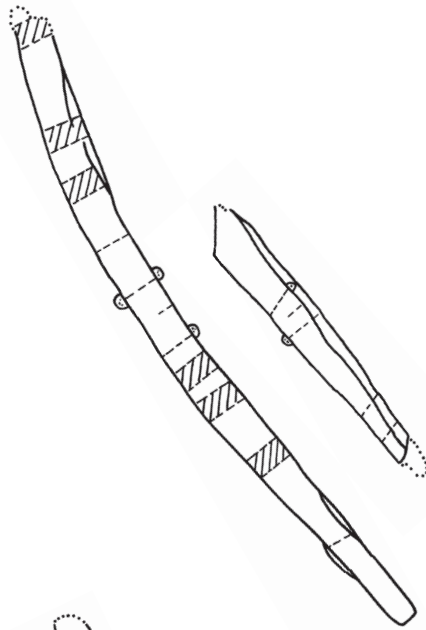

A21



Abb. 58a. – Wrack 2. Spanten A 20* bis A 21*. – M. 1:10.



Abb. 58b. – Wrack 2. Spanten A 20* bis A 21*. – M. 1:10.

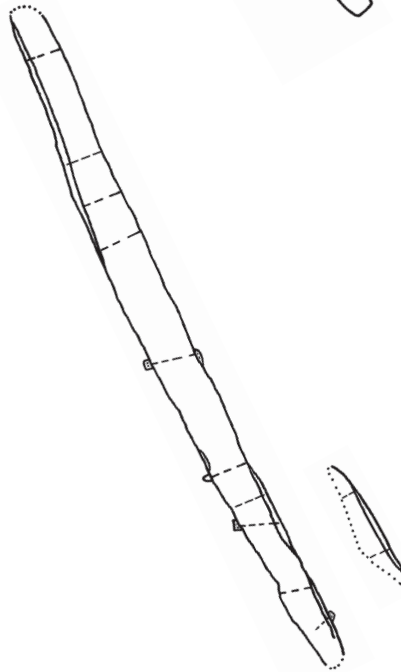

F5

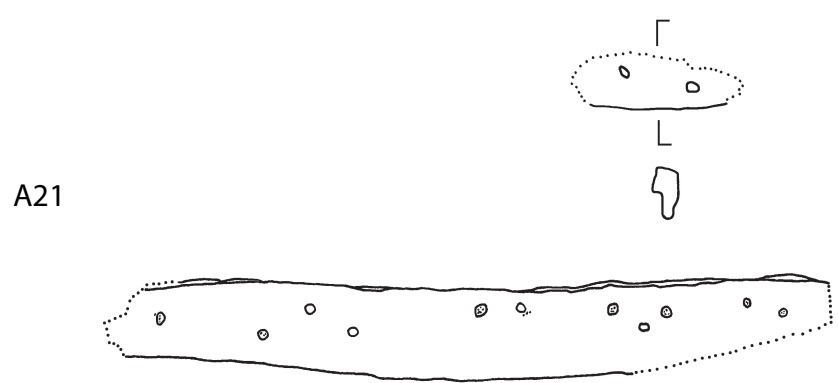
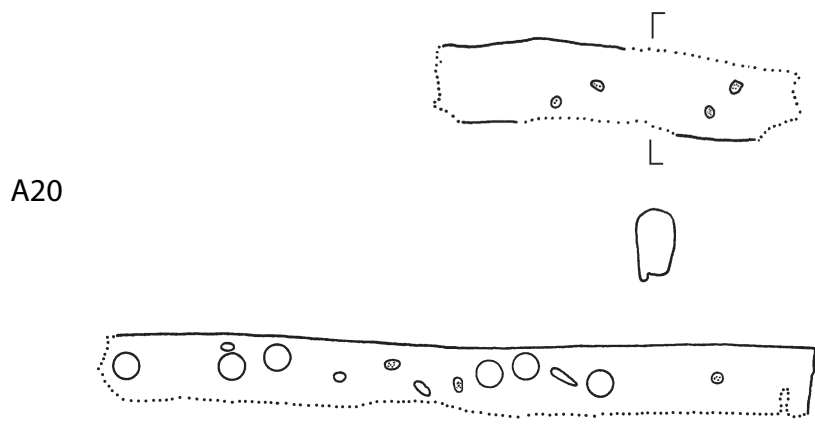

F4



F3



F2

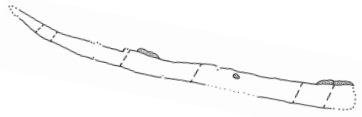

F1

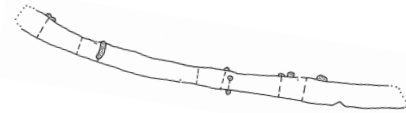

M

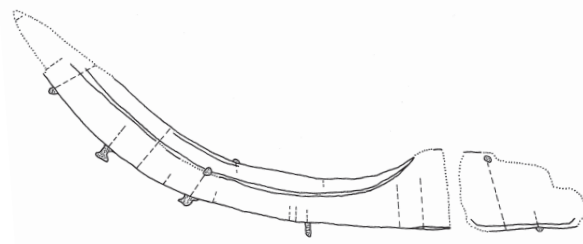

A1



Abb. 59a. – Wrack 3. Spanten F 5 bis A 1. – M. 1:20.



Abb. 59b. – Wrack 3. Spanten F 5 bis A 1. – M. 1:20.

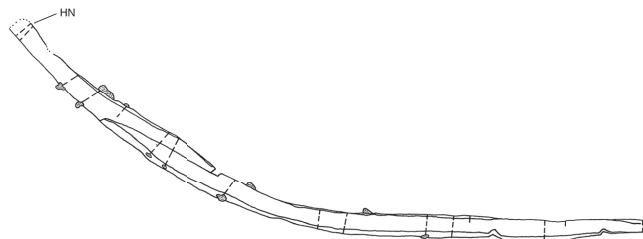

A2

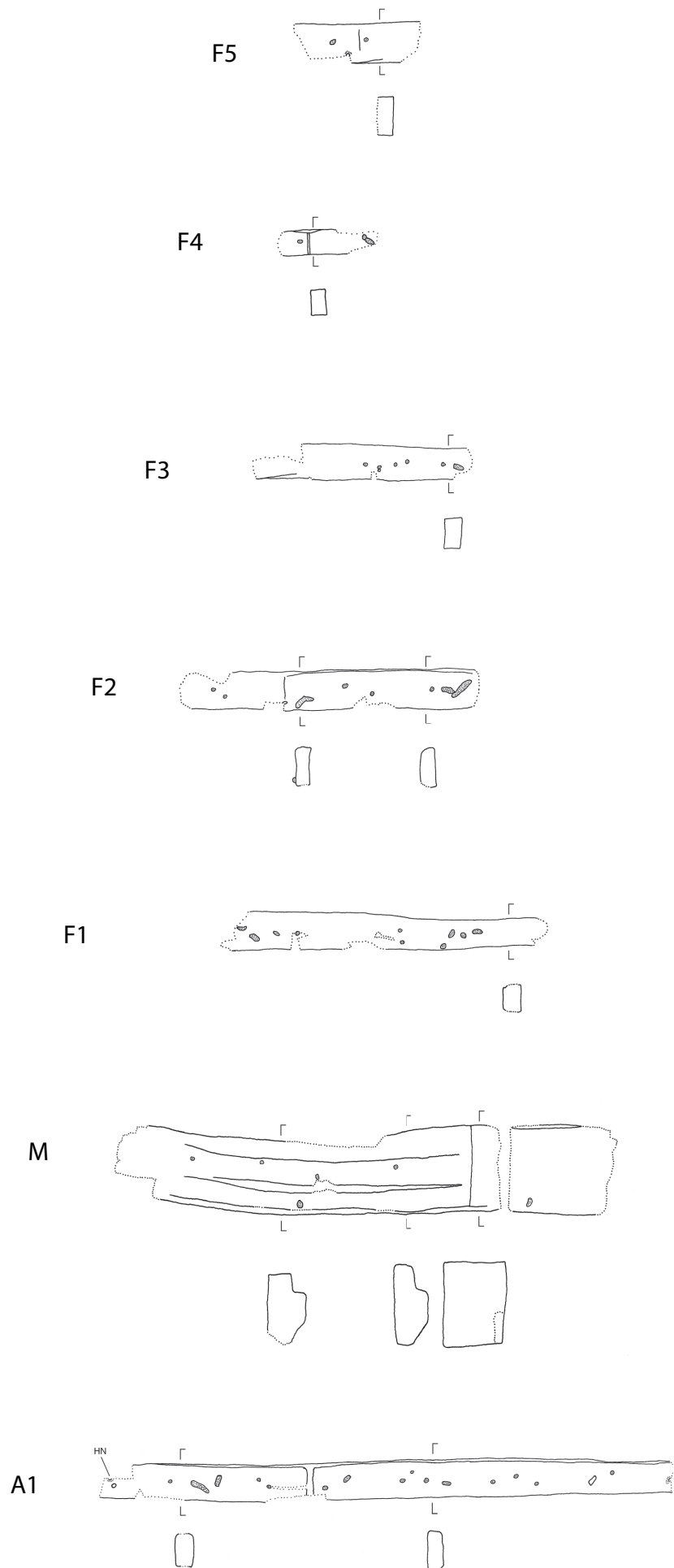

A3

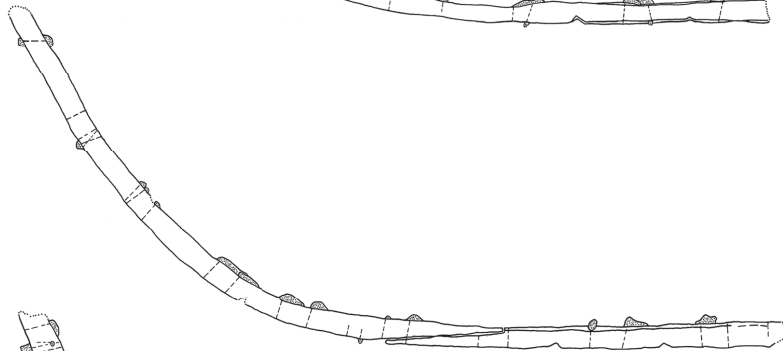

A4

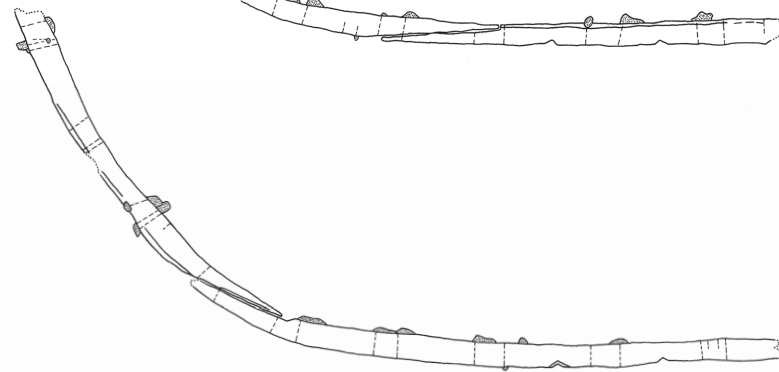

A5

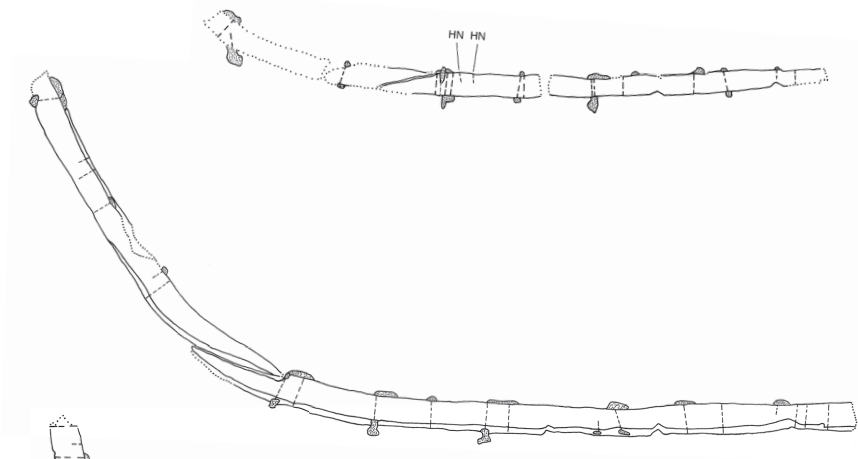

A6

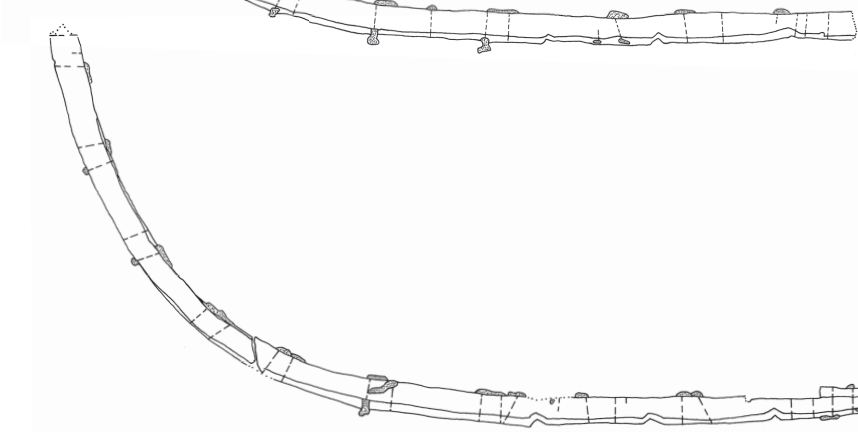

A7

Abb. 60a. – Wrack 3. Spanten A 2 bis A 7. – M. 1:20.



Abb. 60b. – Wrack 3. Spanten A 2 bis A 7. – M. 1:20.



A8

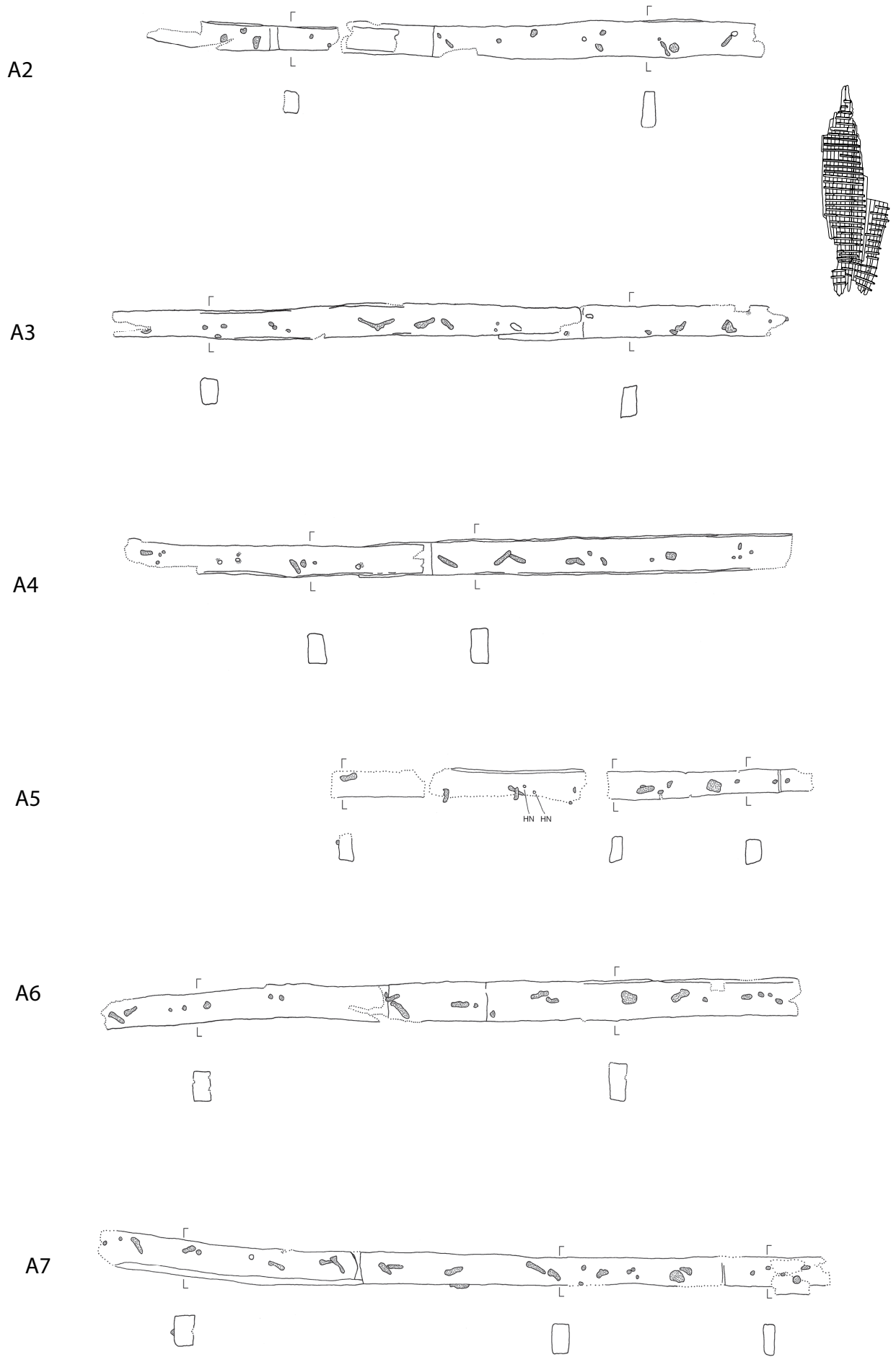
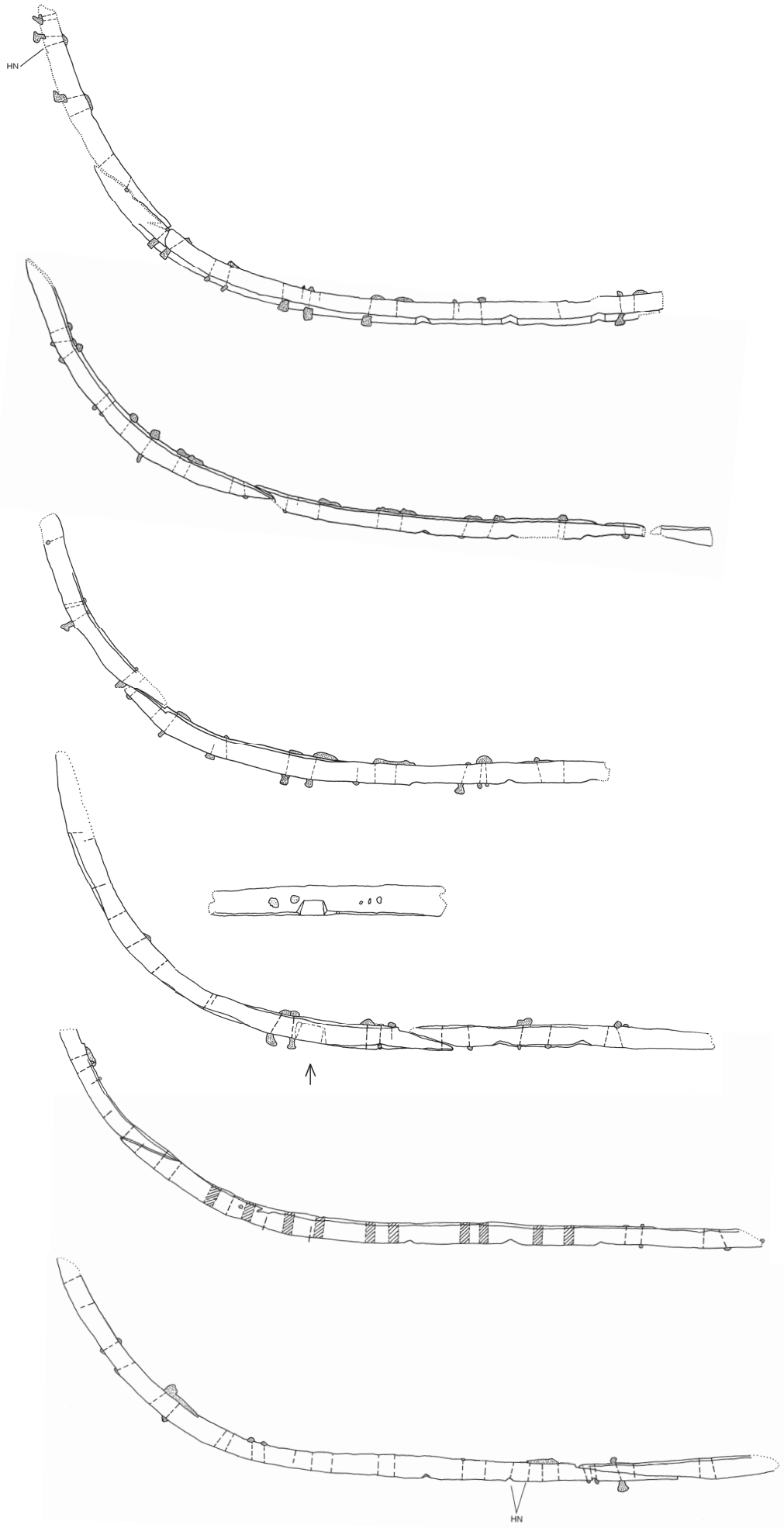

A9

A10

A11

A12

A13

Abb. 61a. – Wrack 3. Spanten A 8 bis A 13. – M. 1:20.



Abb. 61b. – Wrack 3. Spanten A 8 bis A 13. – M. 1:20.



Abb. 62a. – Wrack 3. Spanten A 14 bis A 19. – M. 1:20.

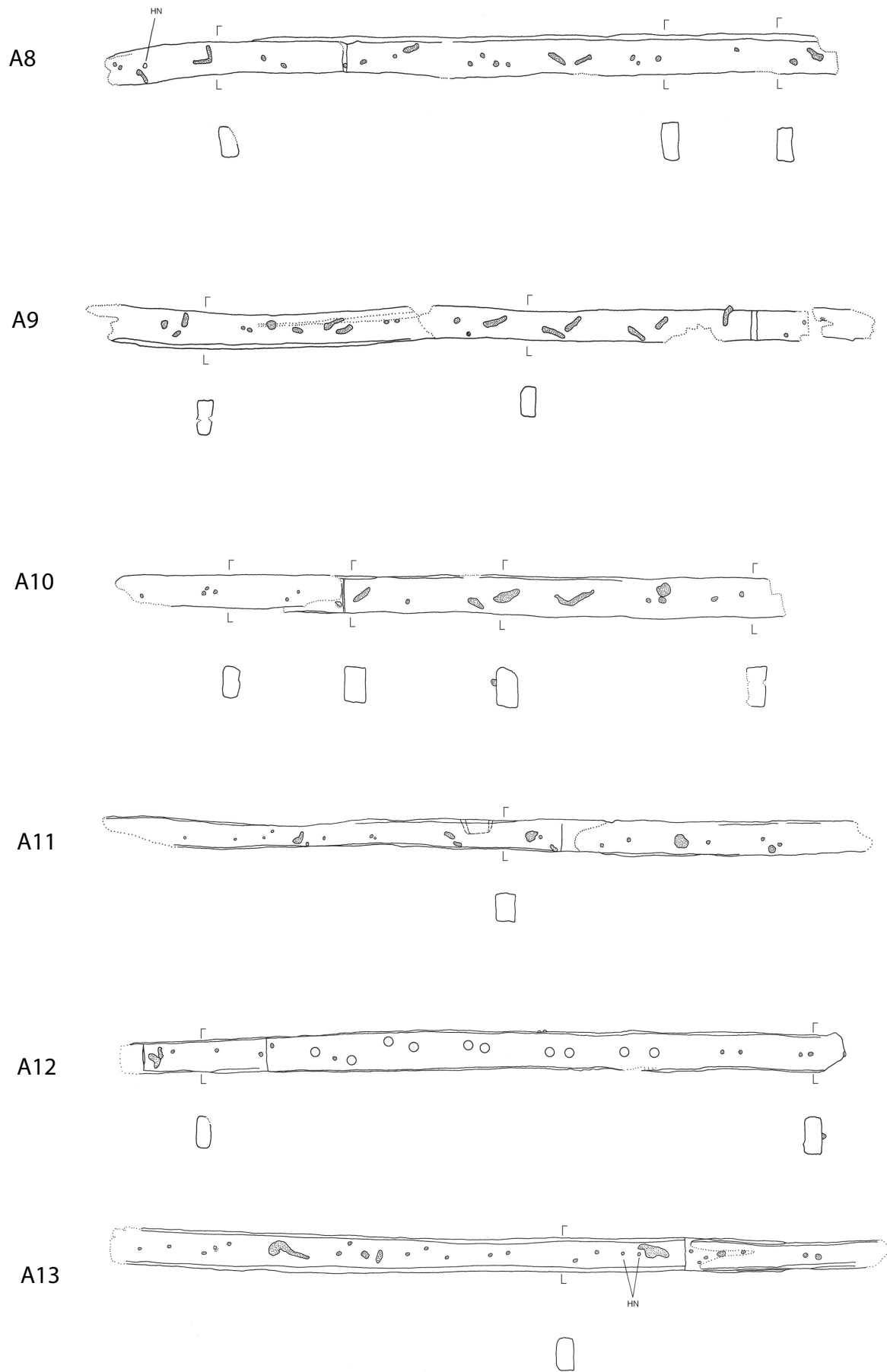

Abb. 62b. – Wrack 3. Spanten A 14 bis A 19. – M. 1:20.

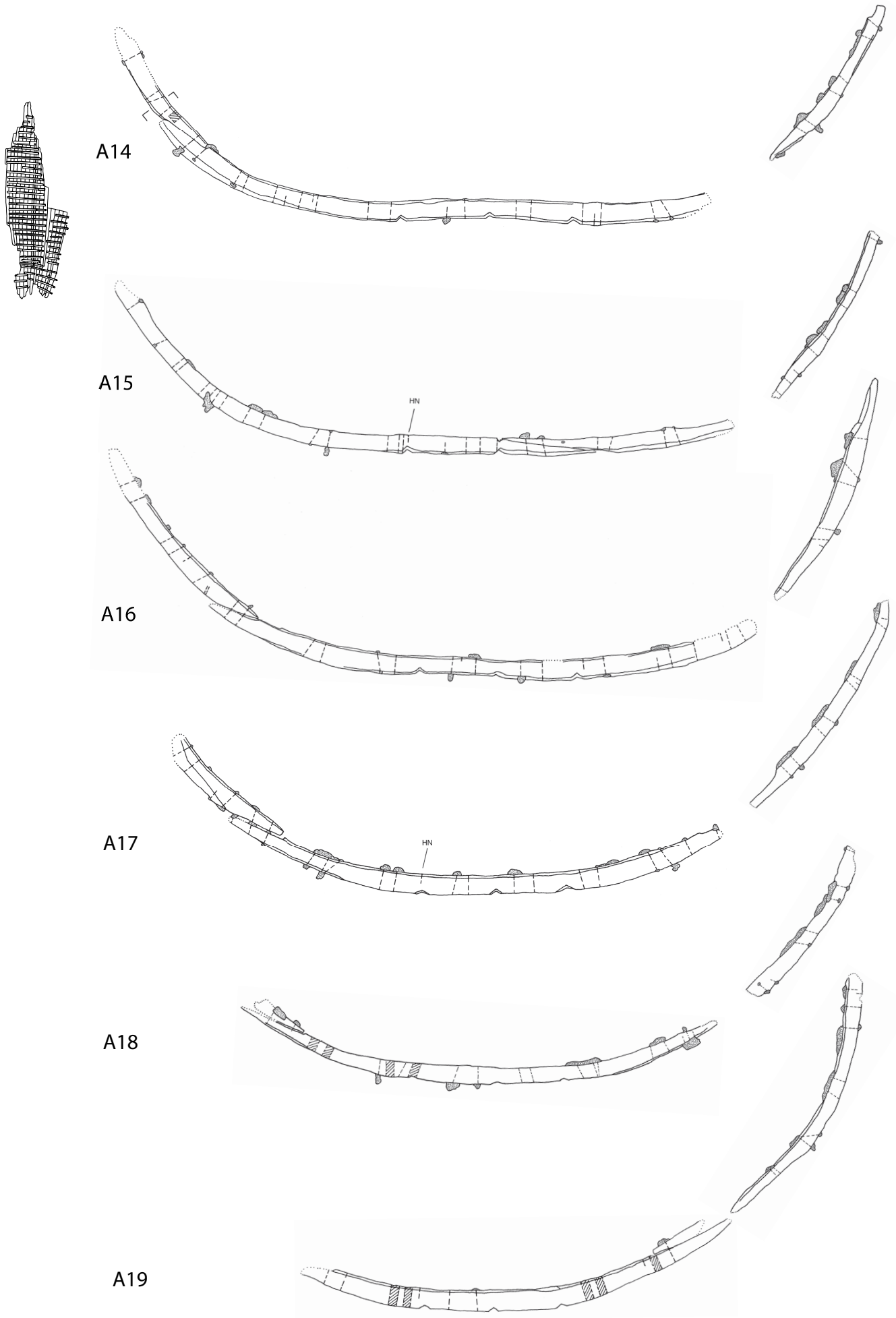

Abb. 63a. – Wrack 3. Spanten A 20 bis A 25. – M. 1:20.

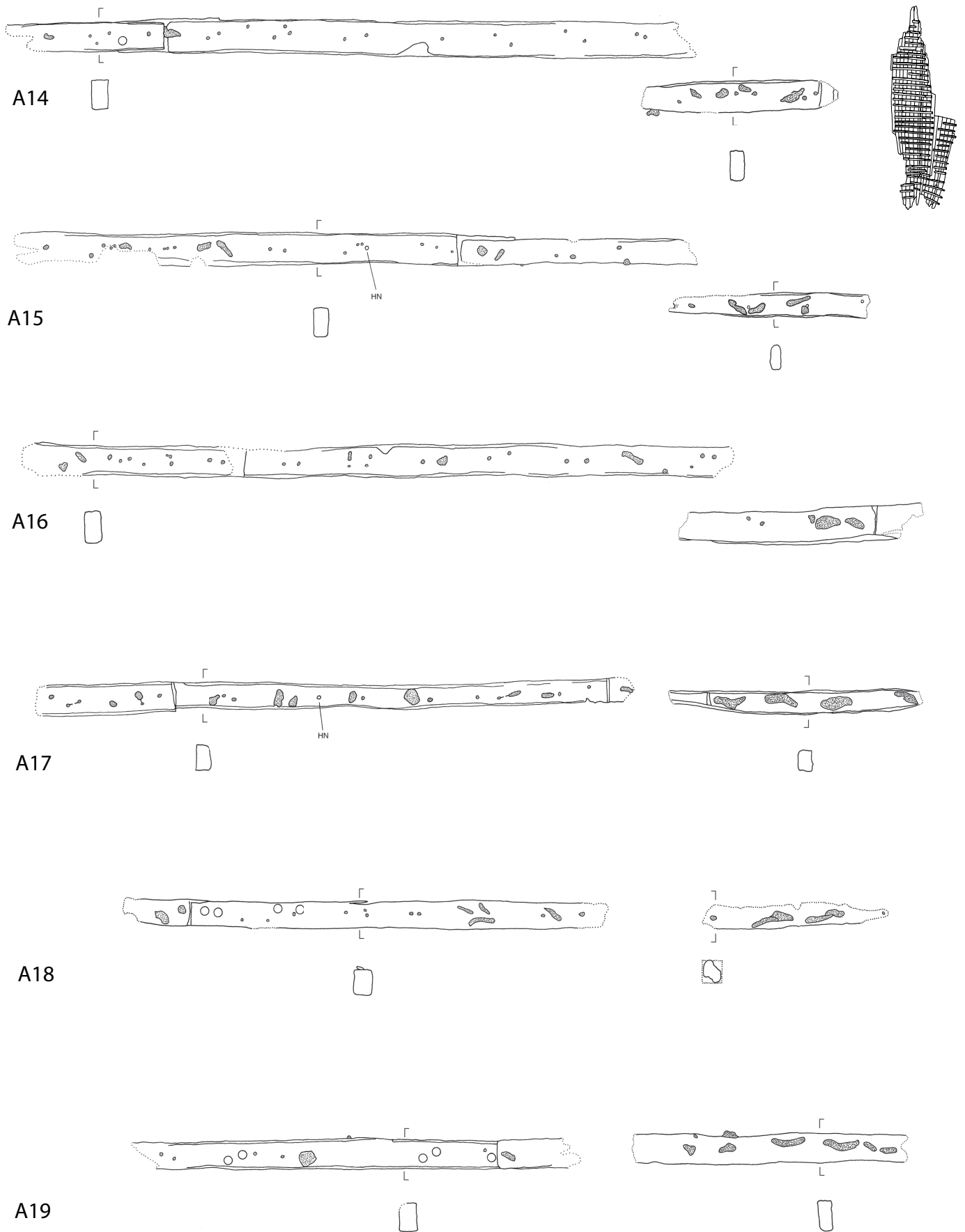

Abb. 63b. – Wrack 3. Spanten A 20 bis A 25. – M. 1:20.

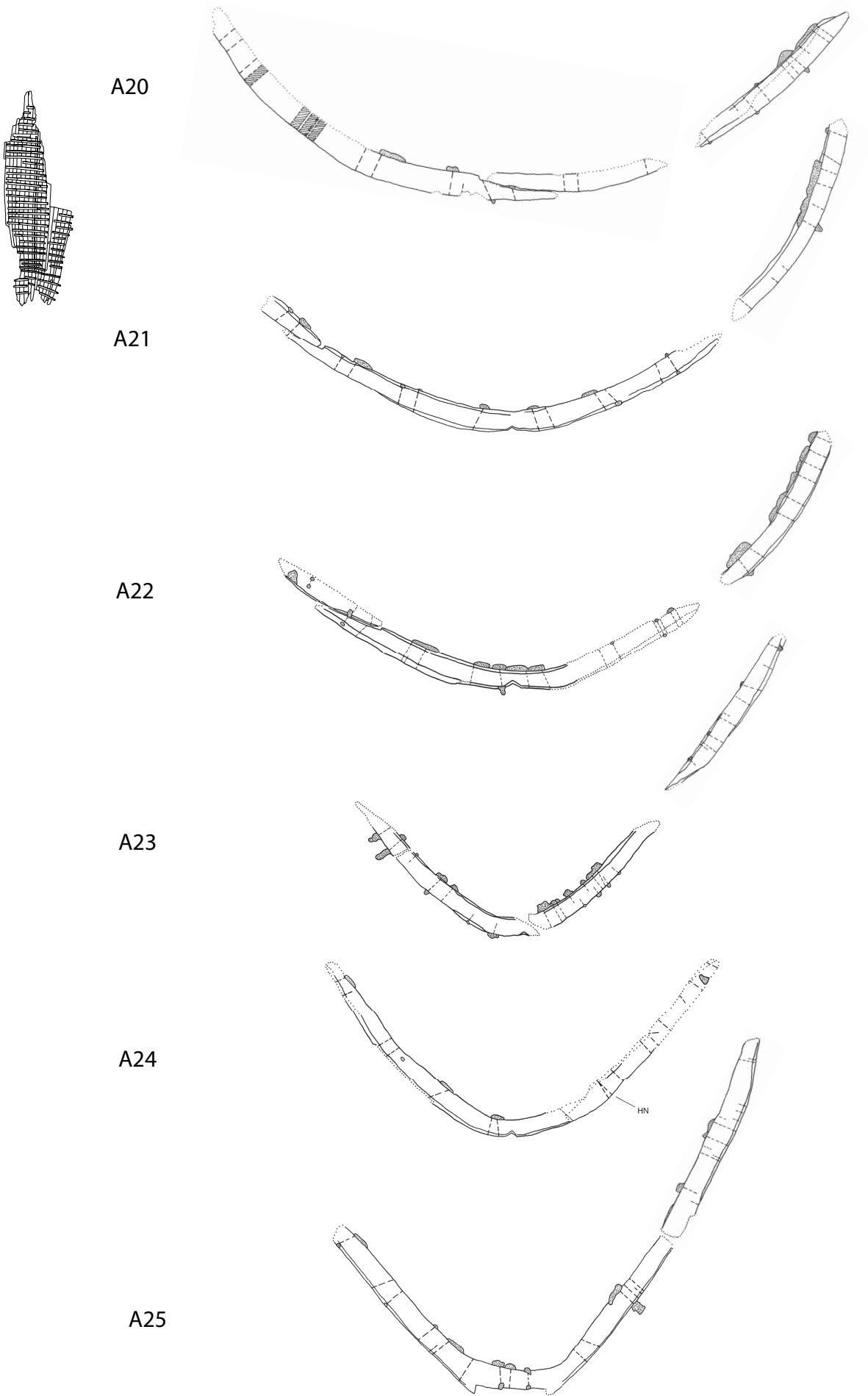

A26

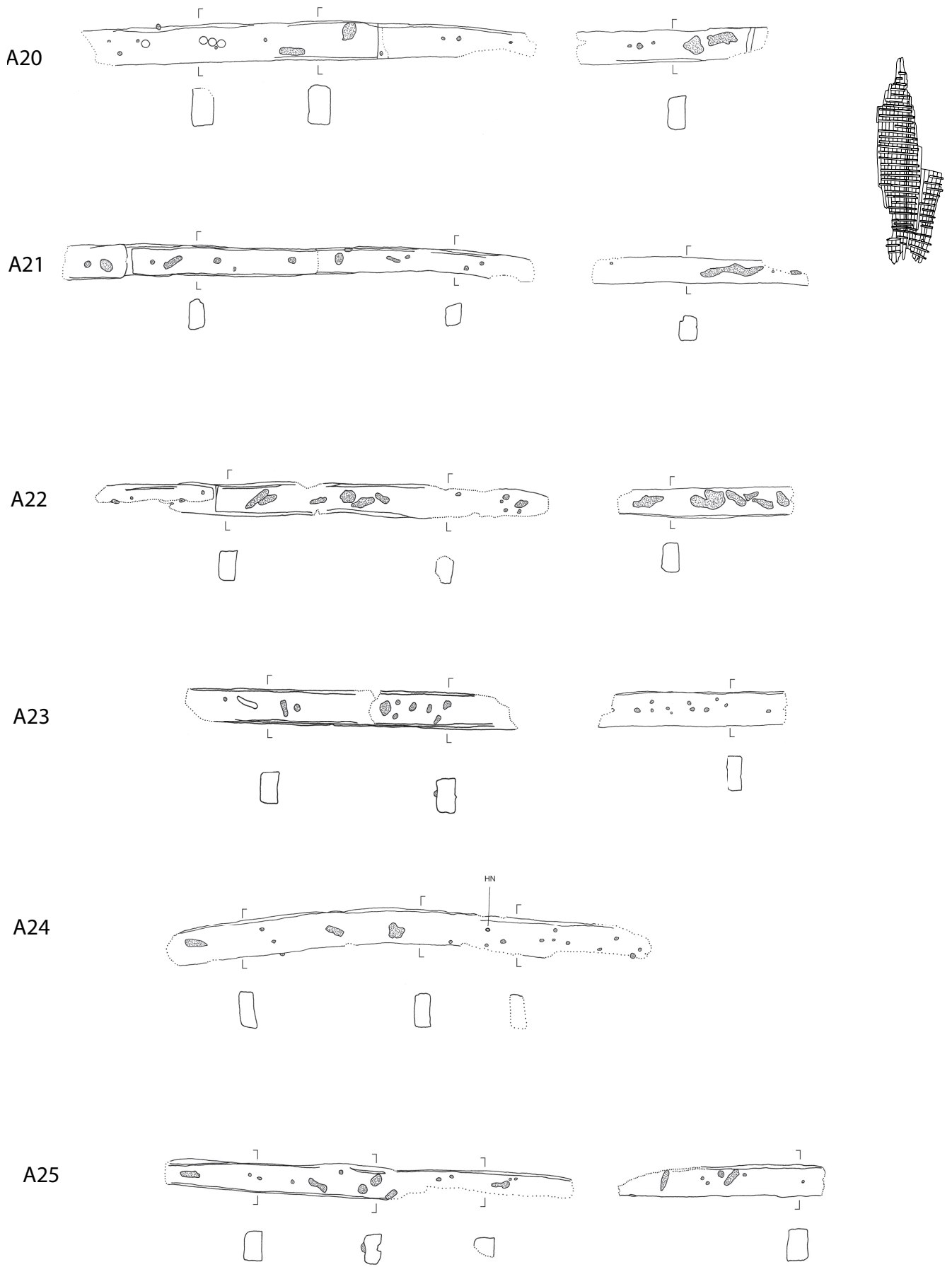
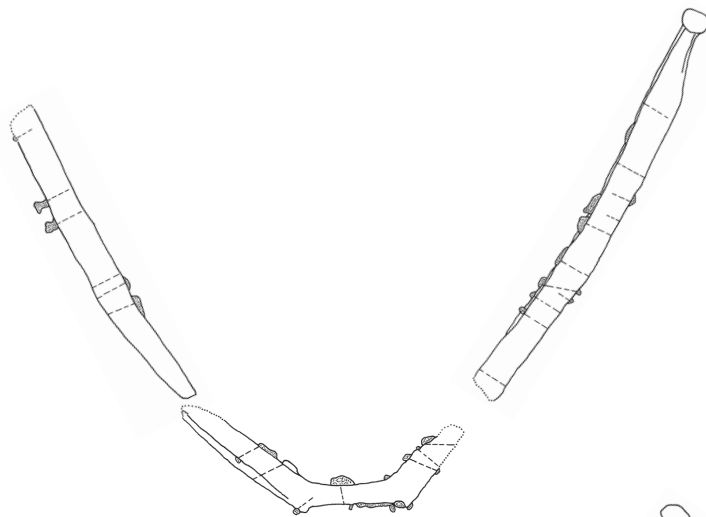

A27

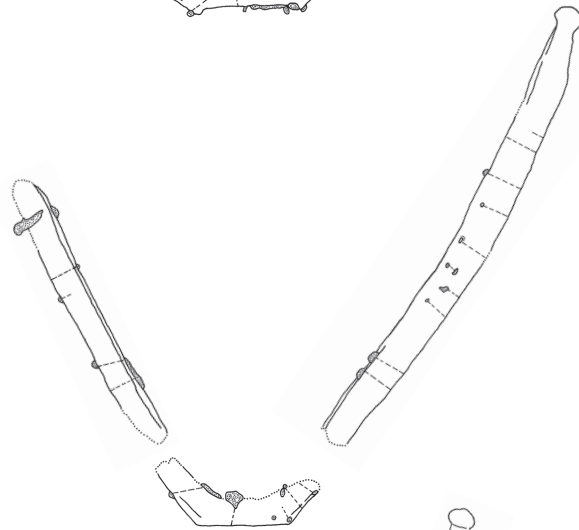

A28



Abb. 64a. – Wrack 3. Spanten A 26 bis A 28. – M. 1:20.

A26



A27

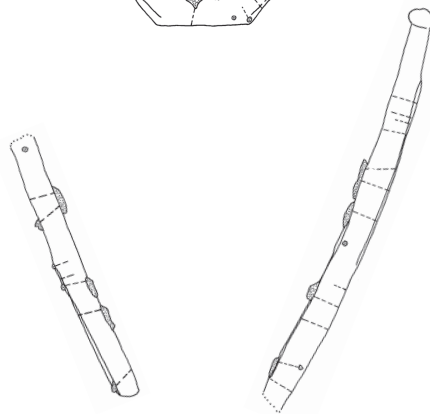
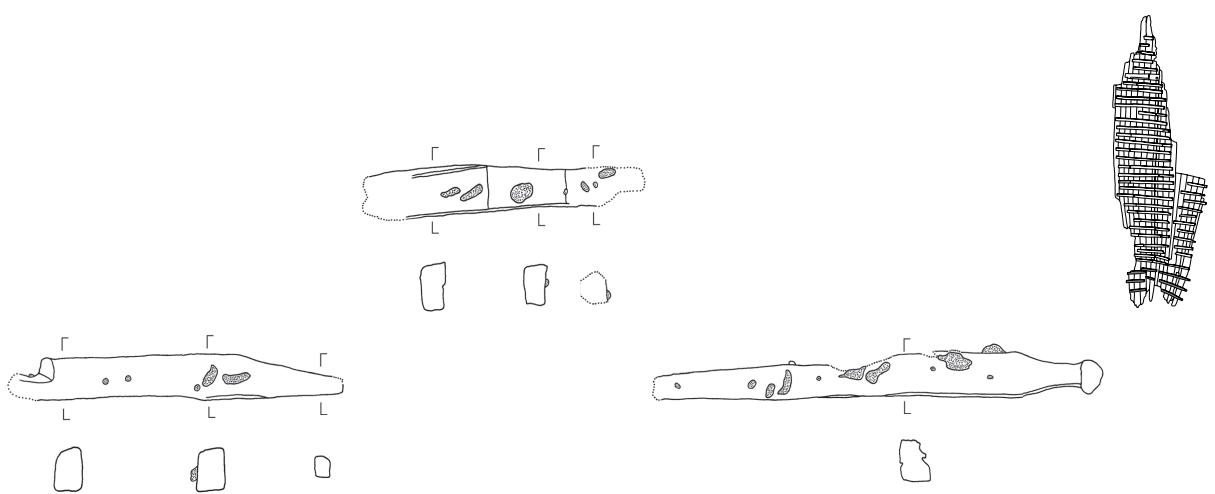
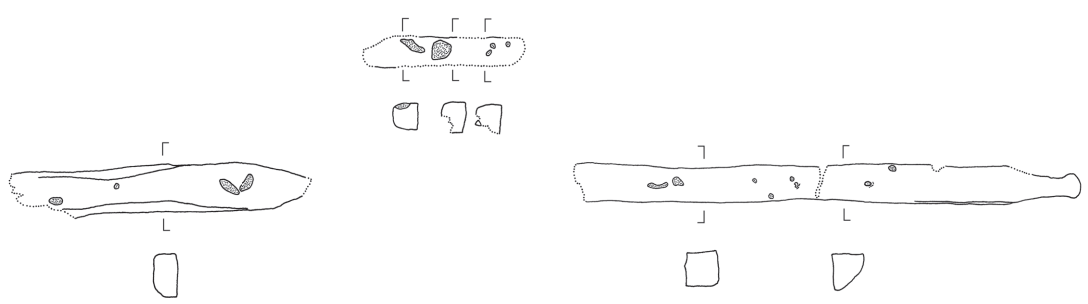

A28



Abb. 64b. – Wrack 3. Spanten A 26 bis A 28. – M. 1:20.



A1

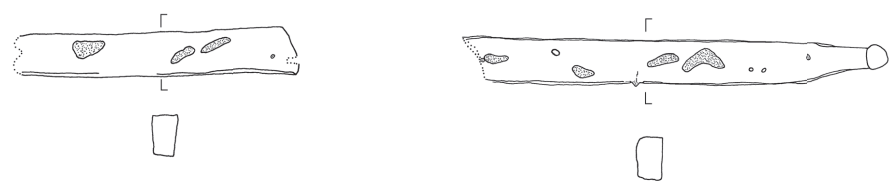
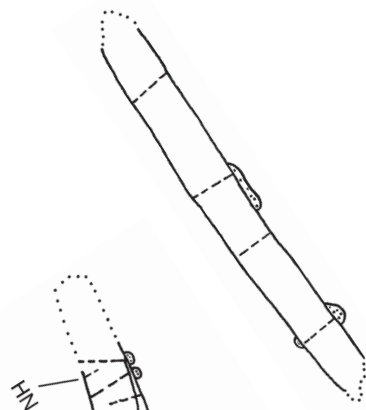

A2

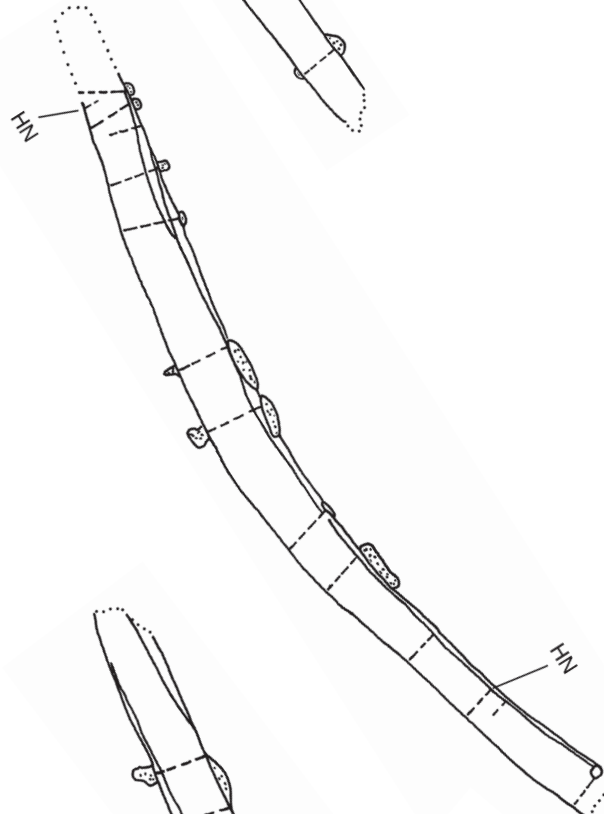

A3

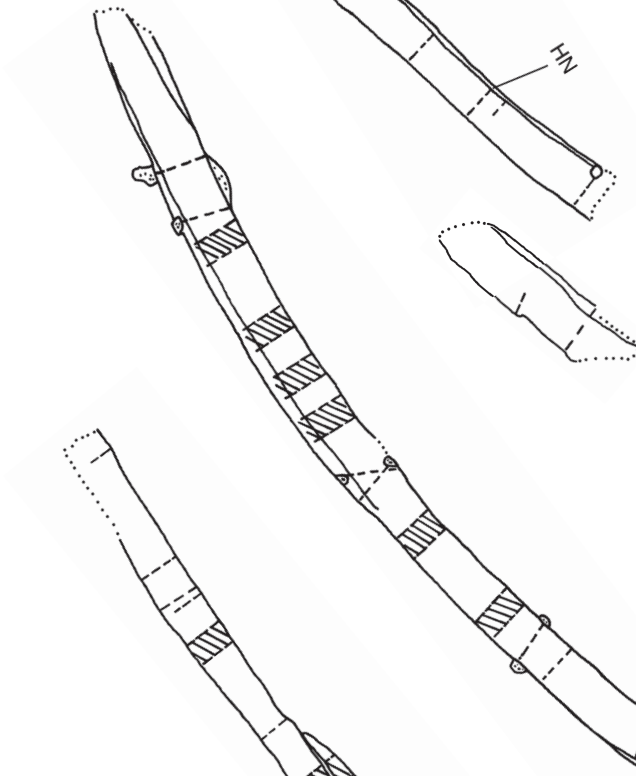

A4



Abb. 65a. – Wrack 4. Spanten A 1* bis A 4*. – M. 1:10.



Abb. 65b. – Wrack 4. Spanten A 1* bis A 4*. – M. 1:10.

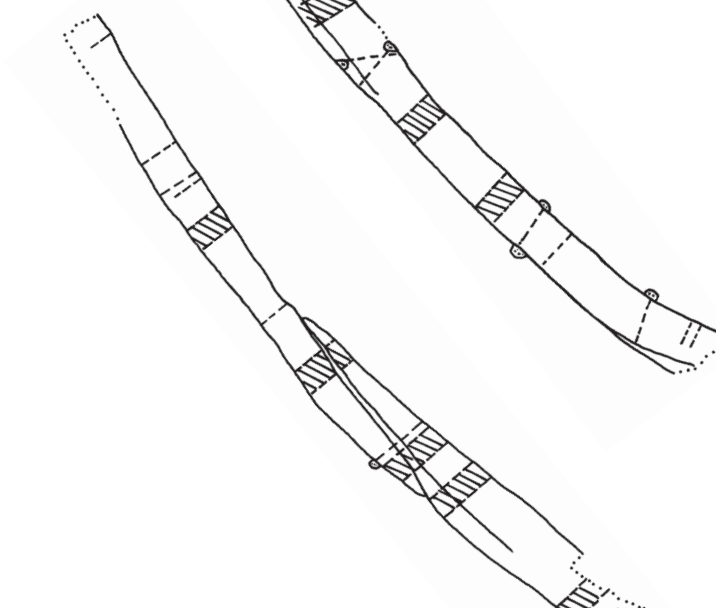

A5

A6

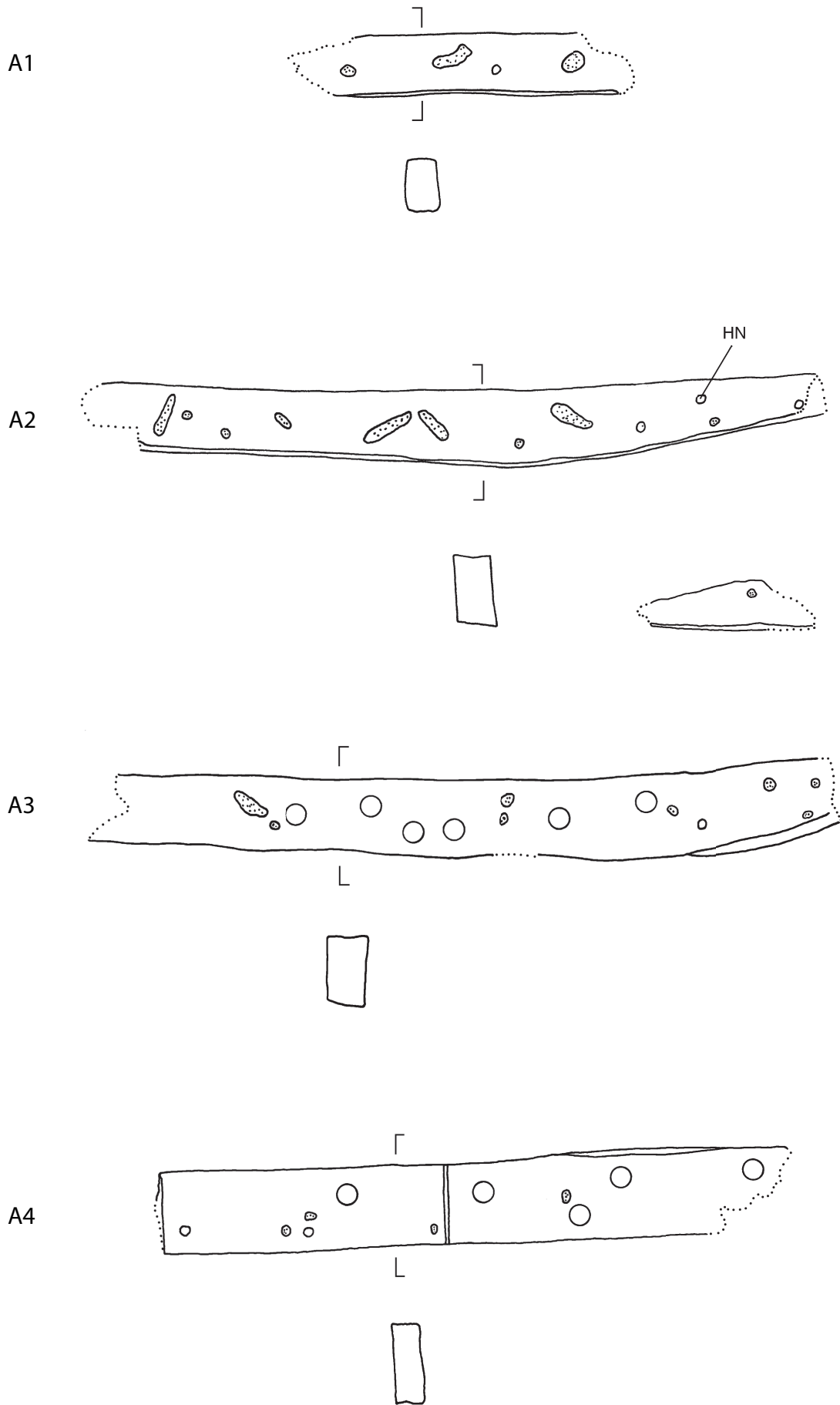
A7

Abb. 66a. – Wrack 4. Spanten A 5* bis A 7*. – M. 1:10.

A5

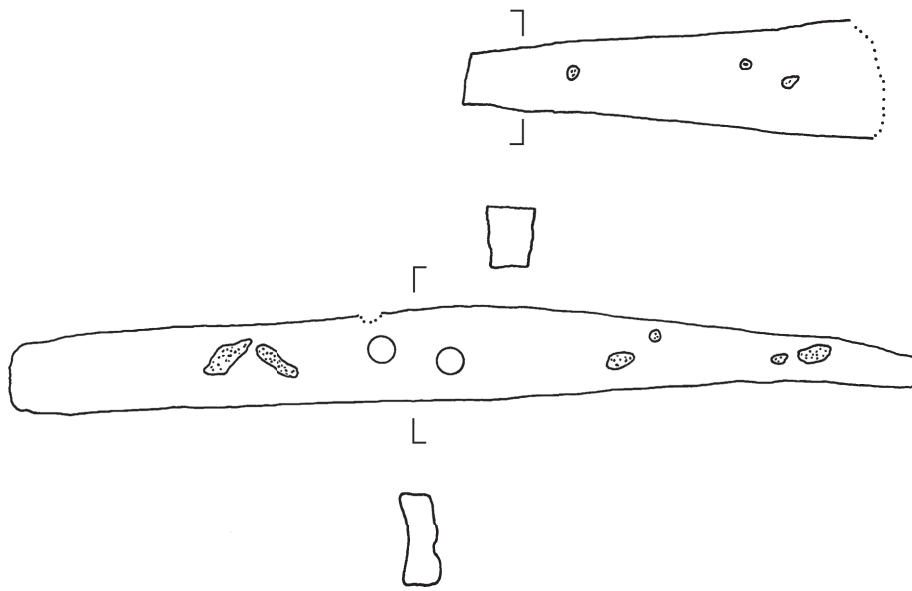

A6

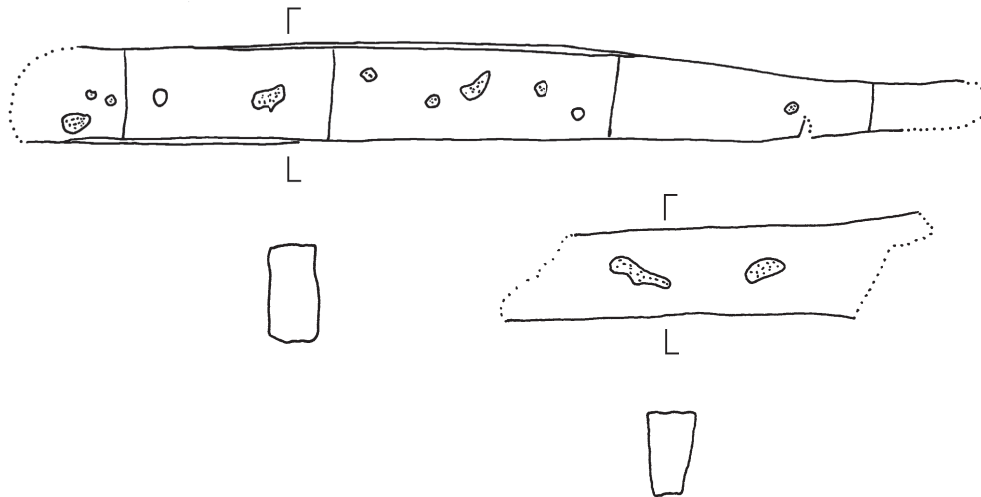

A7



Abb. 66b. – Wrack 4. Spanten A 5* bis A 7*. – M. 1:10.



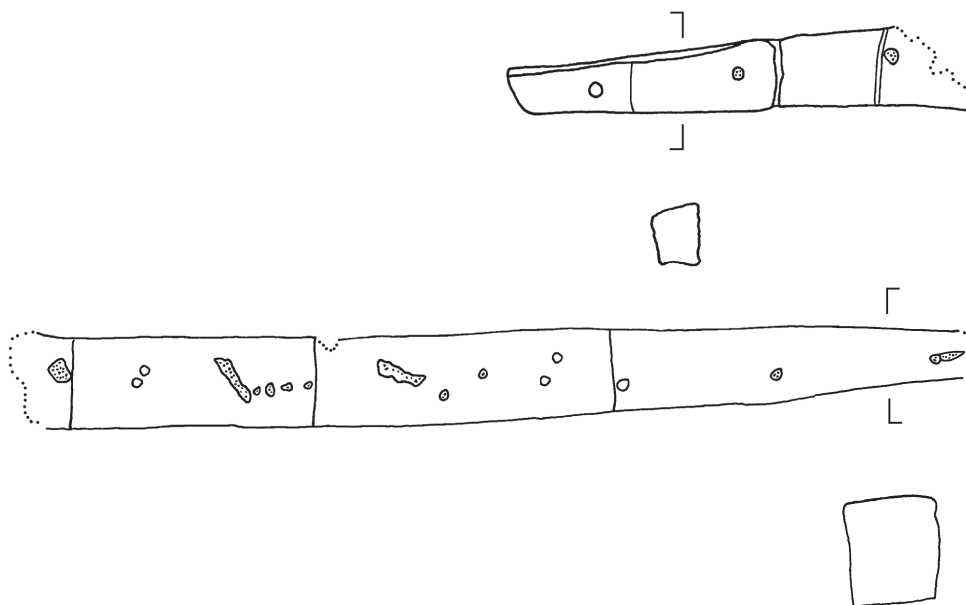

Abb. 67a. – Wrack 4. Spanten A 8* bis A 11*. – M. 1:10.

A8



A9

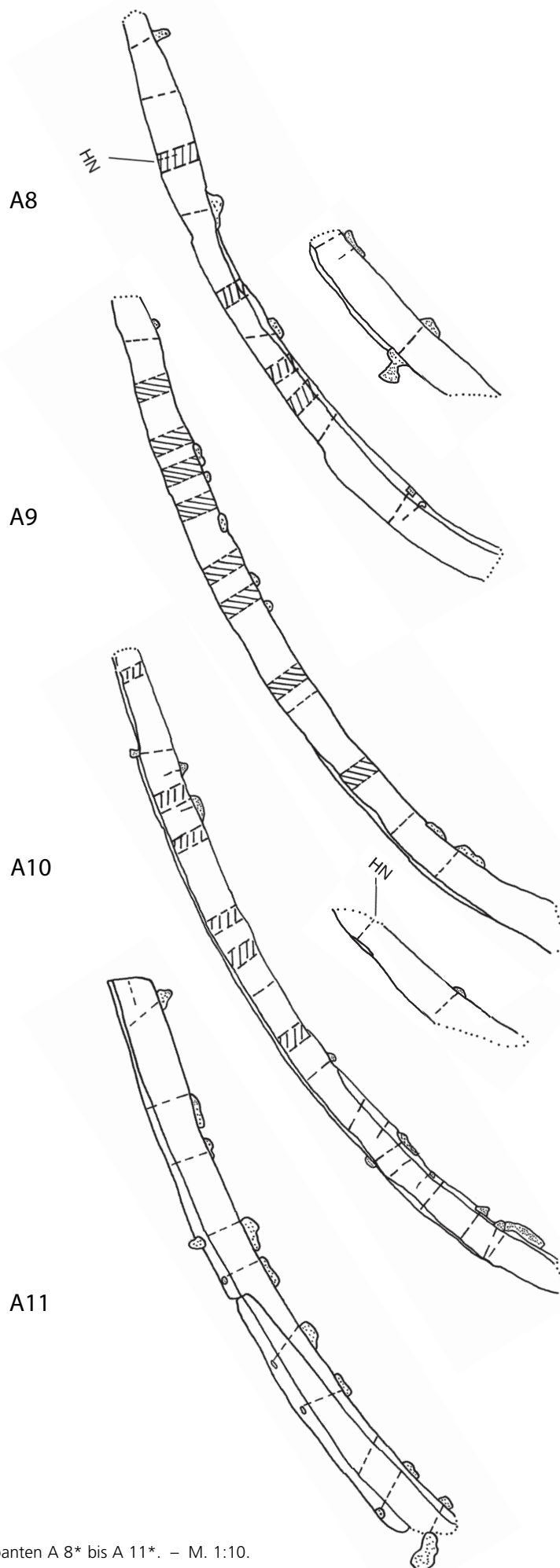
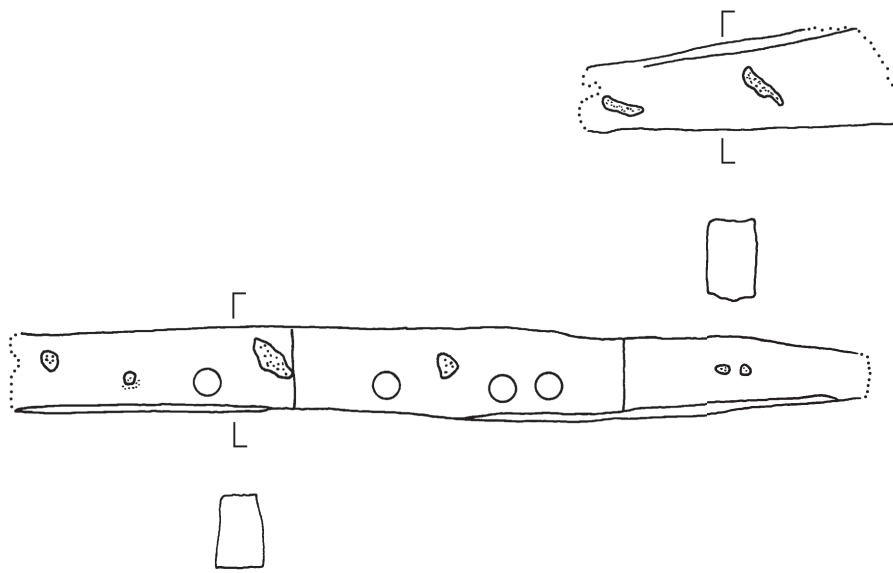
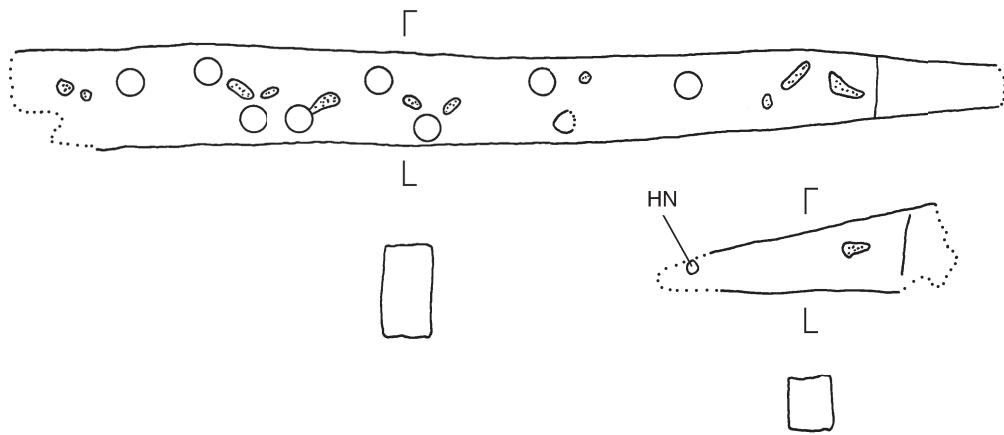

A10

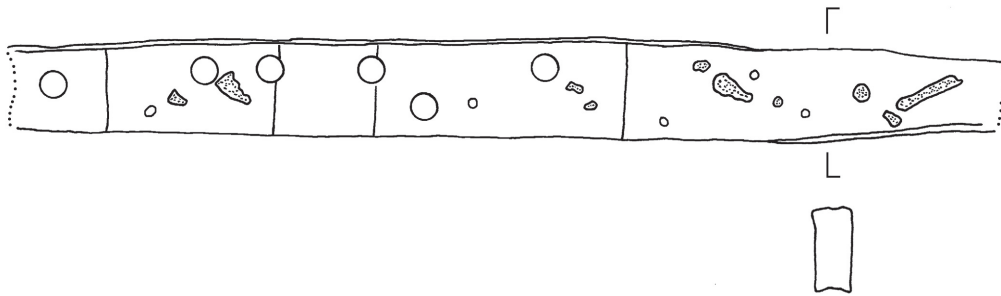

A11



Abb. 67b. – Wrack 4. Spanten A 8* bis A 11*. – M. 1:10.



Abb. 68a. – Wrack 4. Spanten A 12* bis A 15*. – M. 1:10.

A12

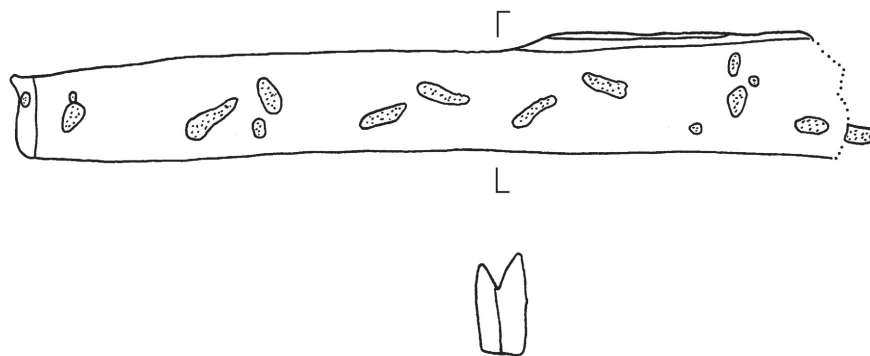

A13

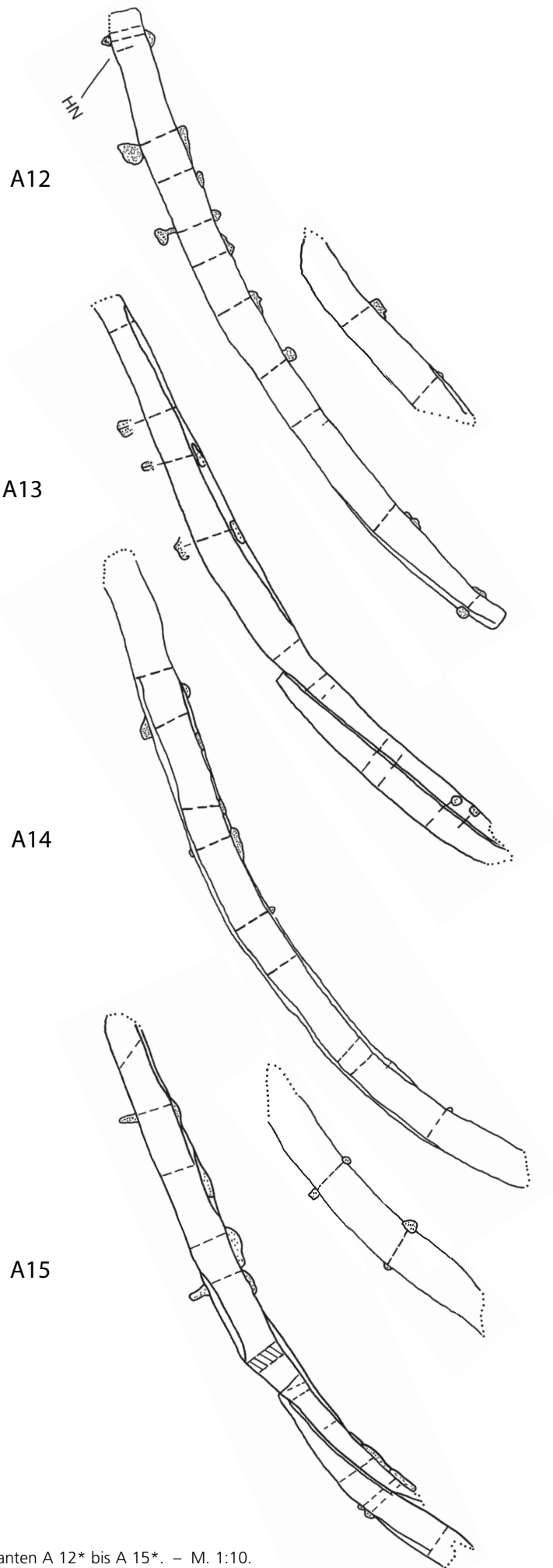
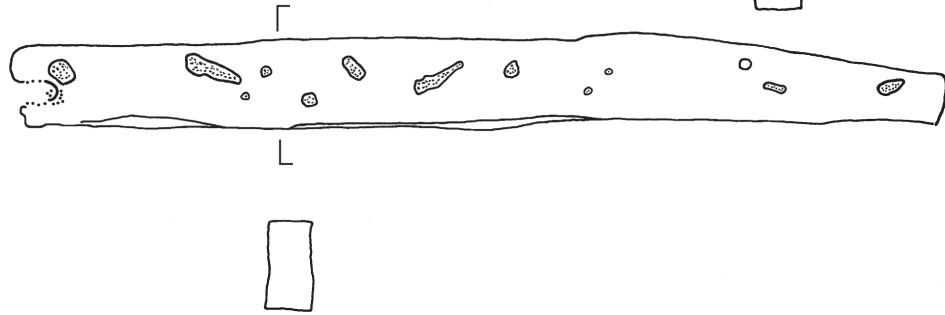
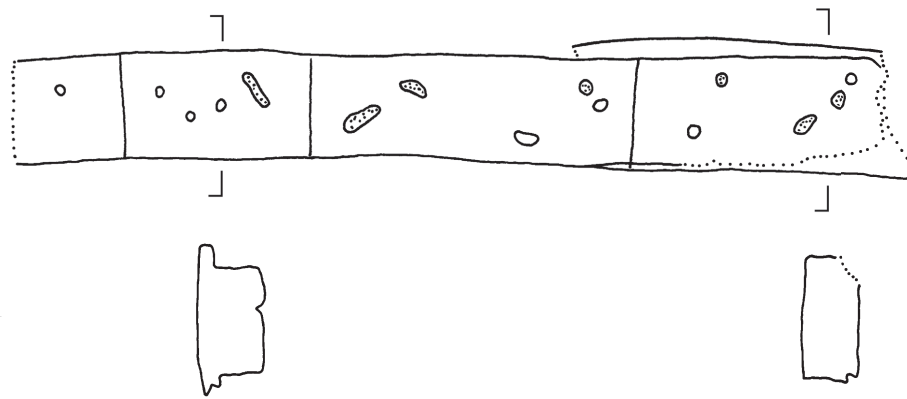

A14

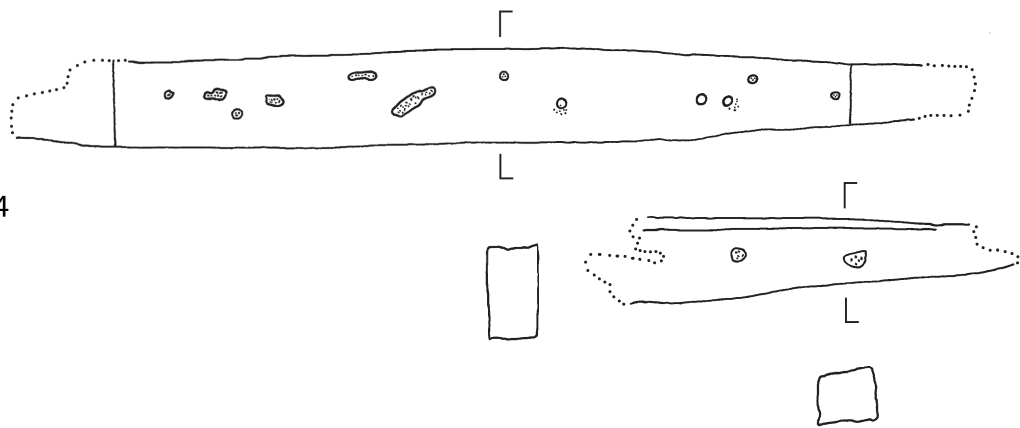

A15



Abb. 68b. – Wrack 4. Spanten A 8* bis A 11*. – M. 1:10.



A16

A17

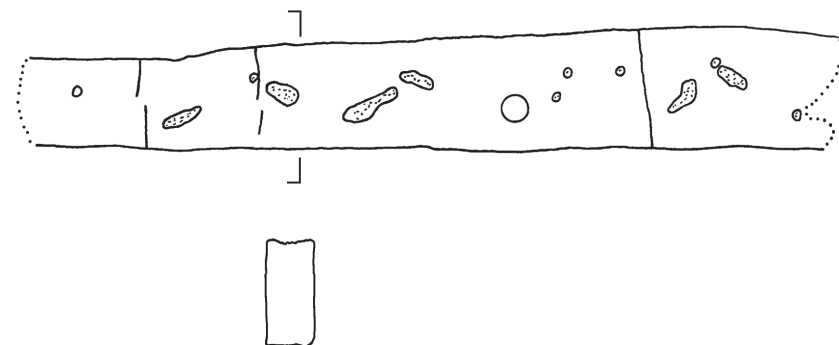
A18

A19



Abb. 69a. – Wrack 4. Spanten A 16* bis A 19*. – M. 1:10.



Abb. 69b. – Wrack 4. Spanten A 16* bis A 19*. – M. 1:10.

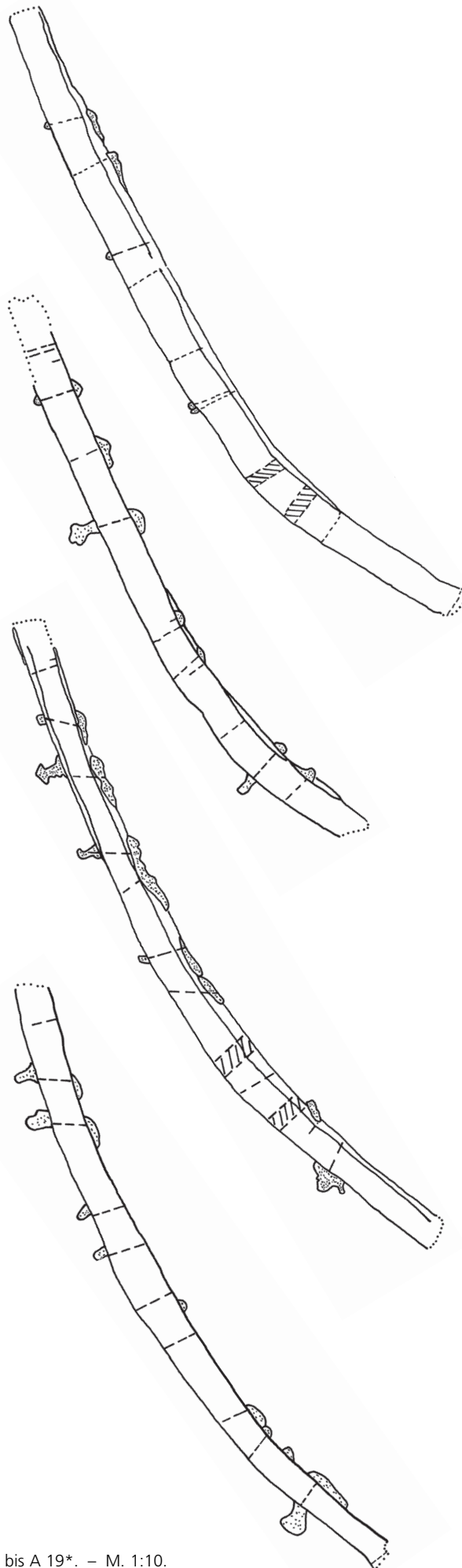

Abb. 70a. – Wrack 4. Spanten A 20* bis A 23*. – M. 1:10.

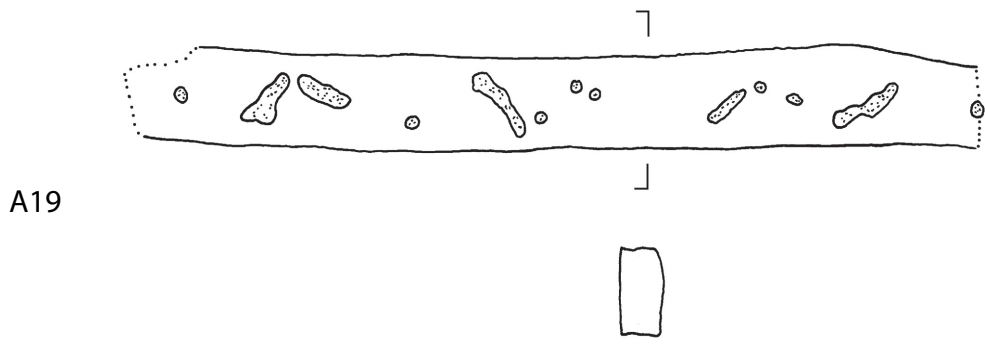
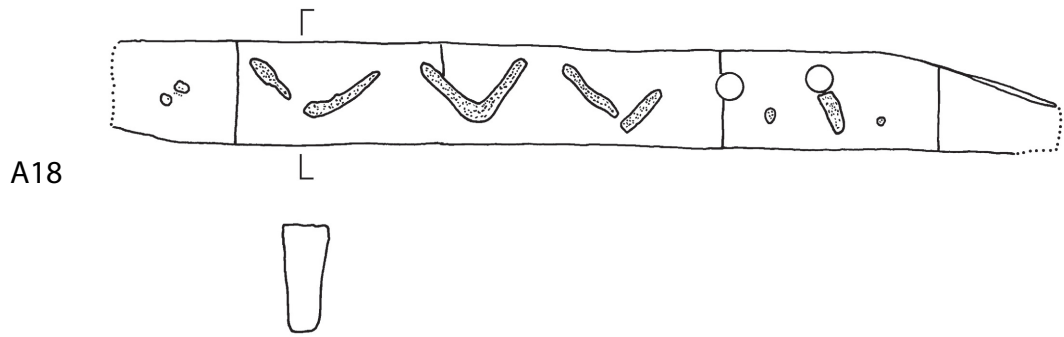
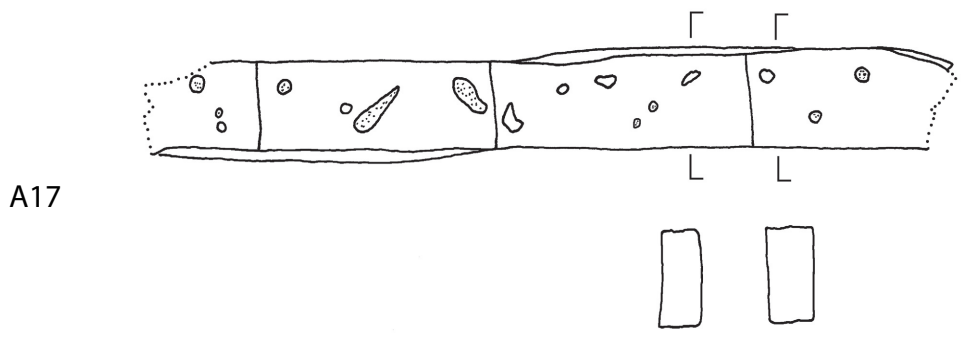
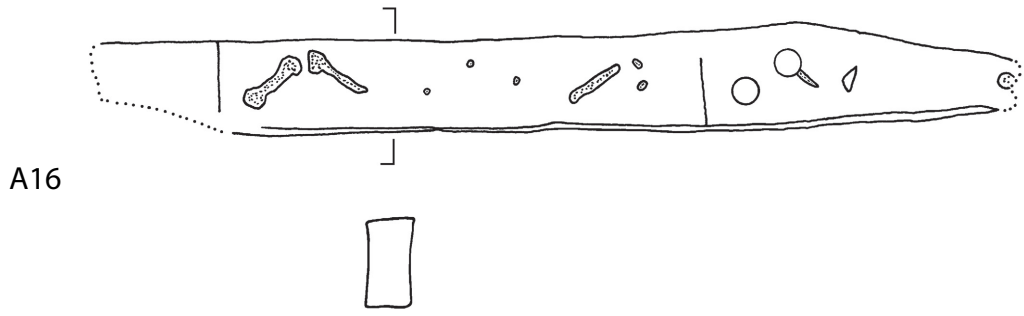

Abb. 70b. – Wrack 4. Spanten A 20* bis A 23*. – M. 1:10.

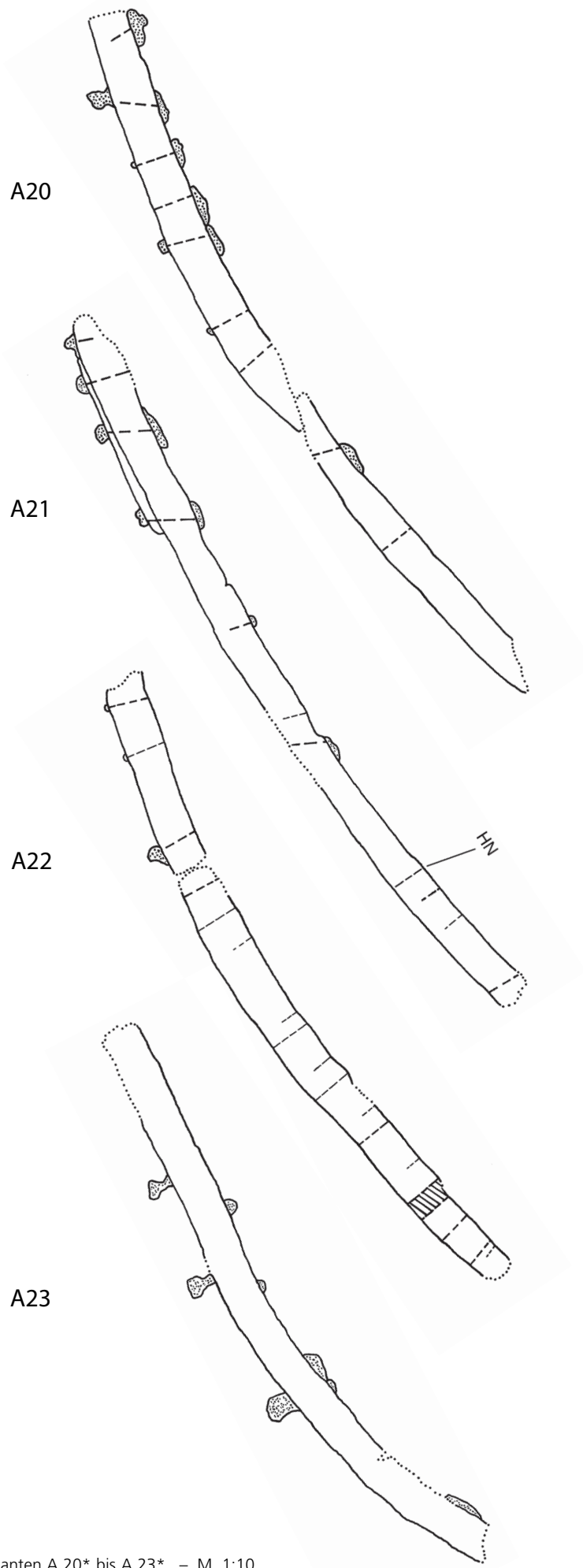

A24

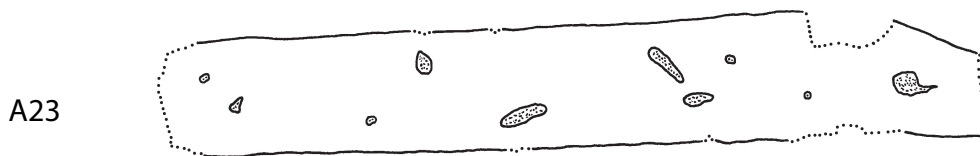
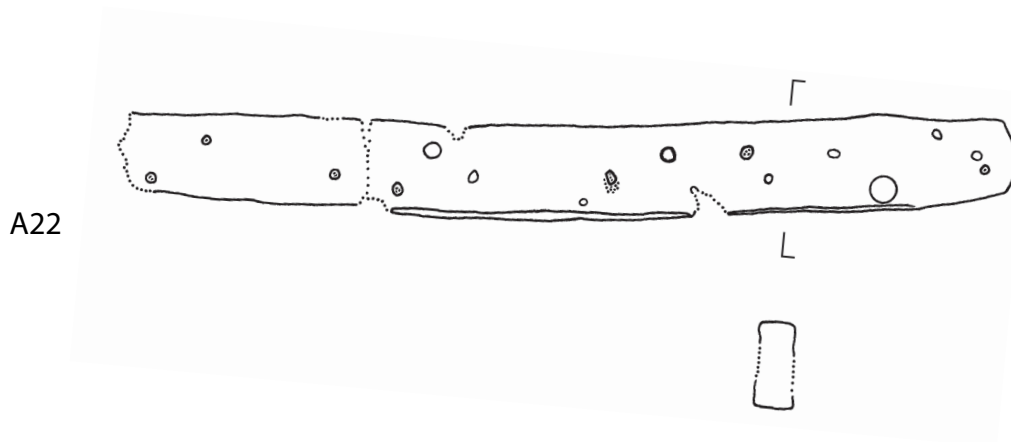
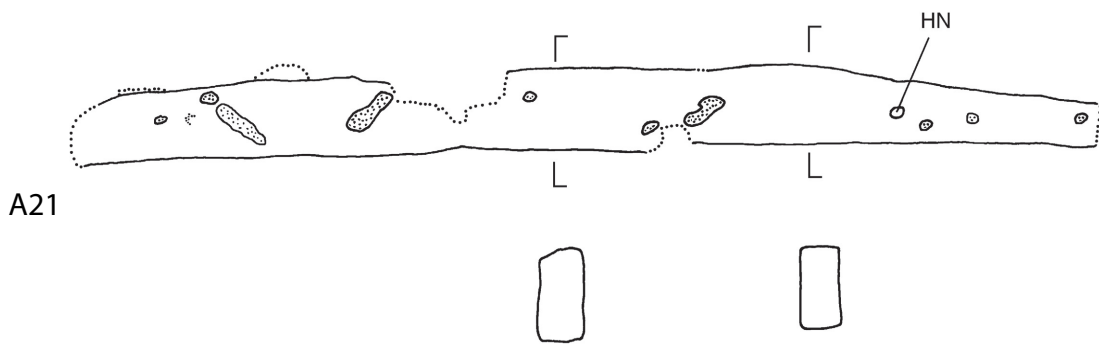
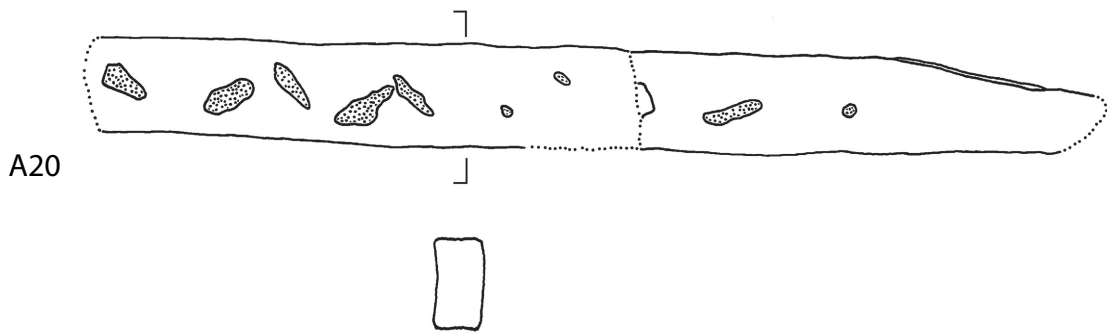
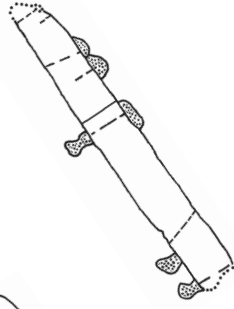

A25

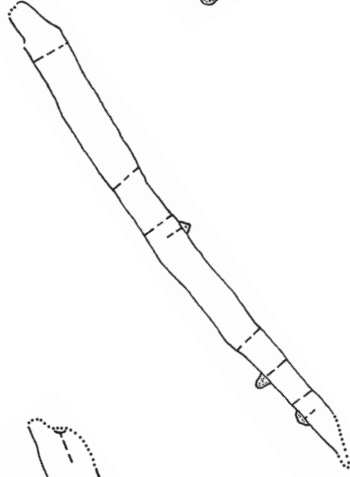

A26

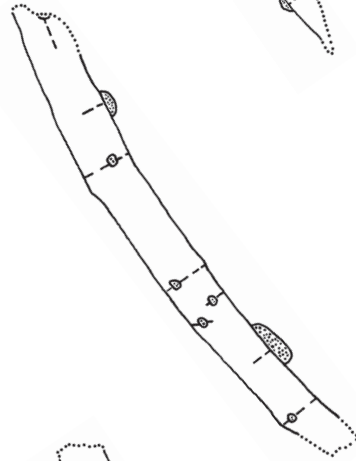

A27



Abb. 71a. – Wrack 4. Spanten A 24* bis A 27*. – M. 1:10.



A24

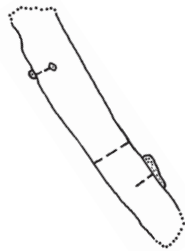
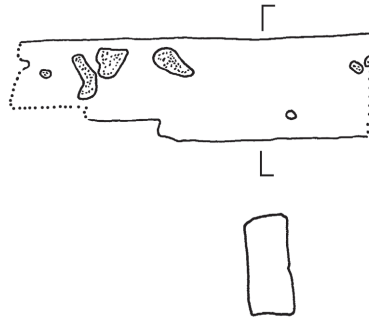

A25

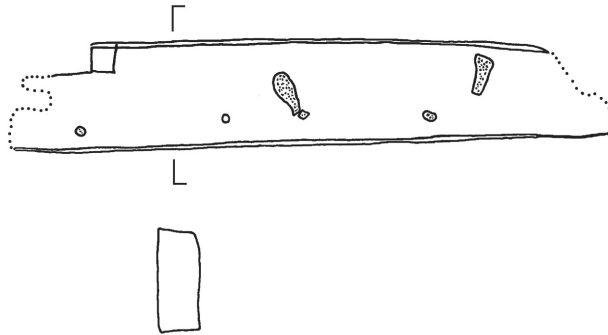

A26

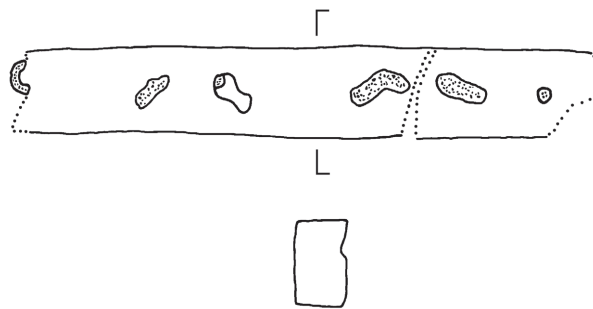

A27



Abb. 71b. – Wrack 4. Spanten A 24* bis A 27*. – M. 1:10.



F15

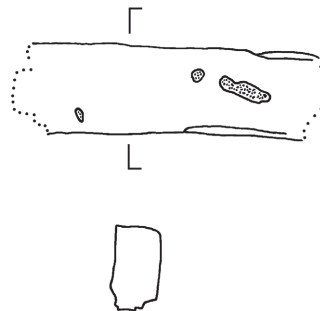
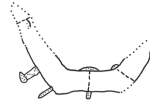

F14

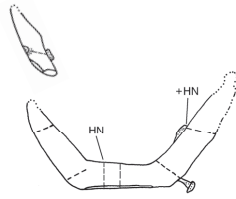

F13

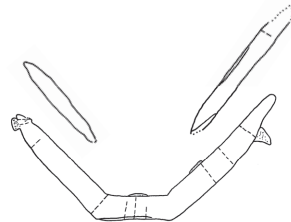

F12

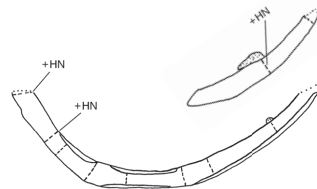

F11

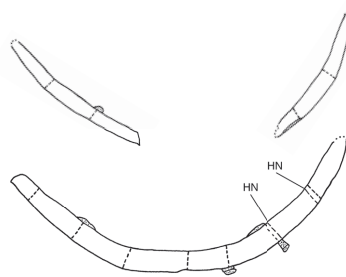

F10

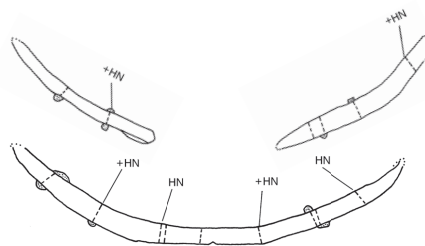

F9



Abb. 72a. – Wrack 5. Spanten F 16 bis F 9. – M. 1:20.



F8

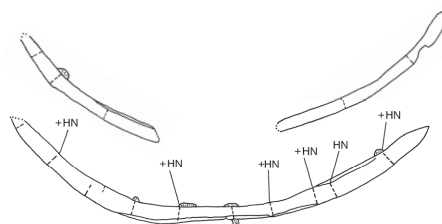
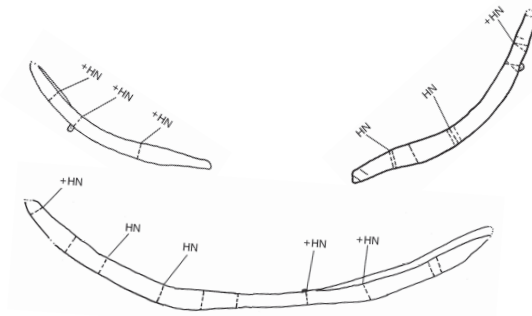

F7

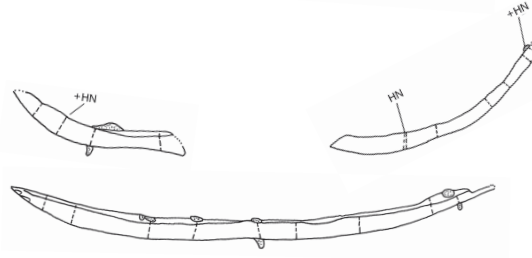

F6

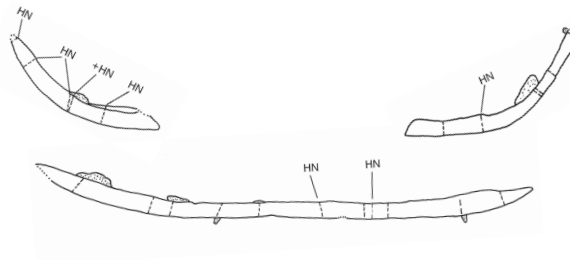

F5



F4

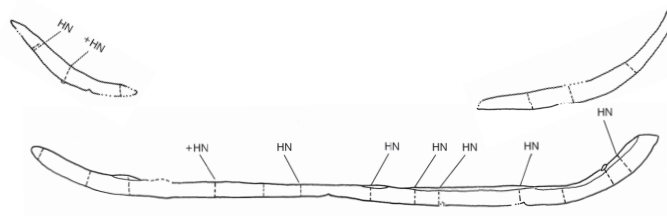

F3

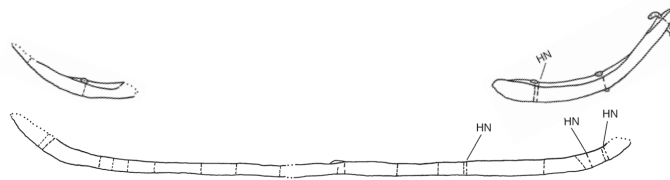

F2



Abb. 73a. – Wrack 5. Spanten F 8 bis F 2. – M. 1:20.



Abb. 73b. – Wrack 5. Spanten F 8 bis F 2. – M. 1:20.

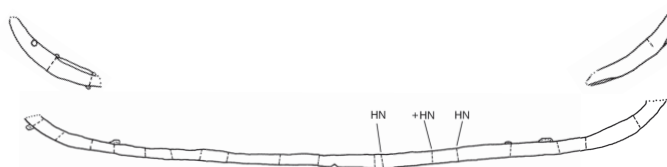

Abb. 74a. – Wrack 5. Spanten F 1 bis A 5. – M. 1:20.

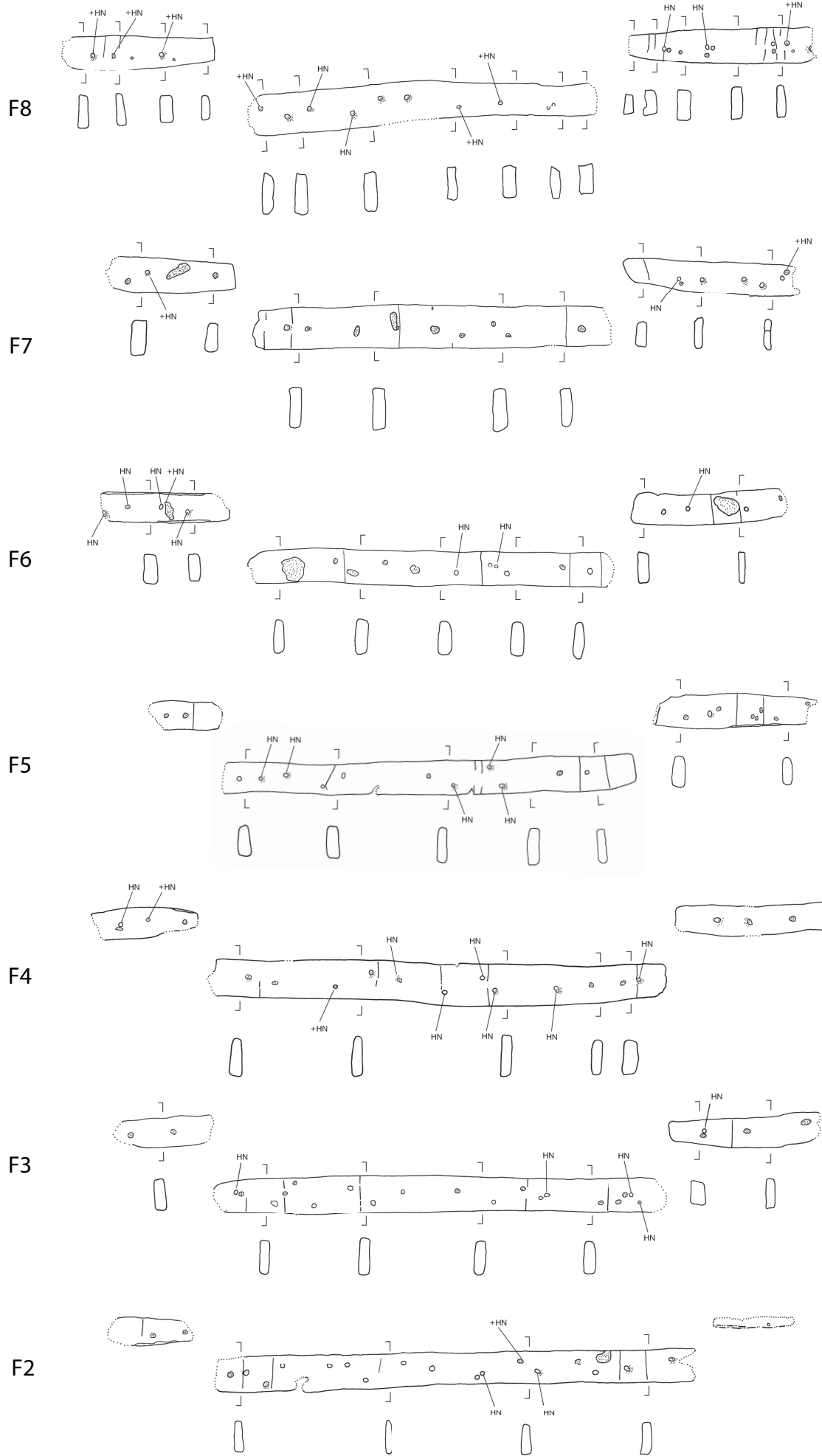
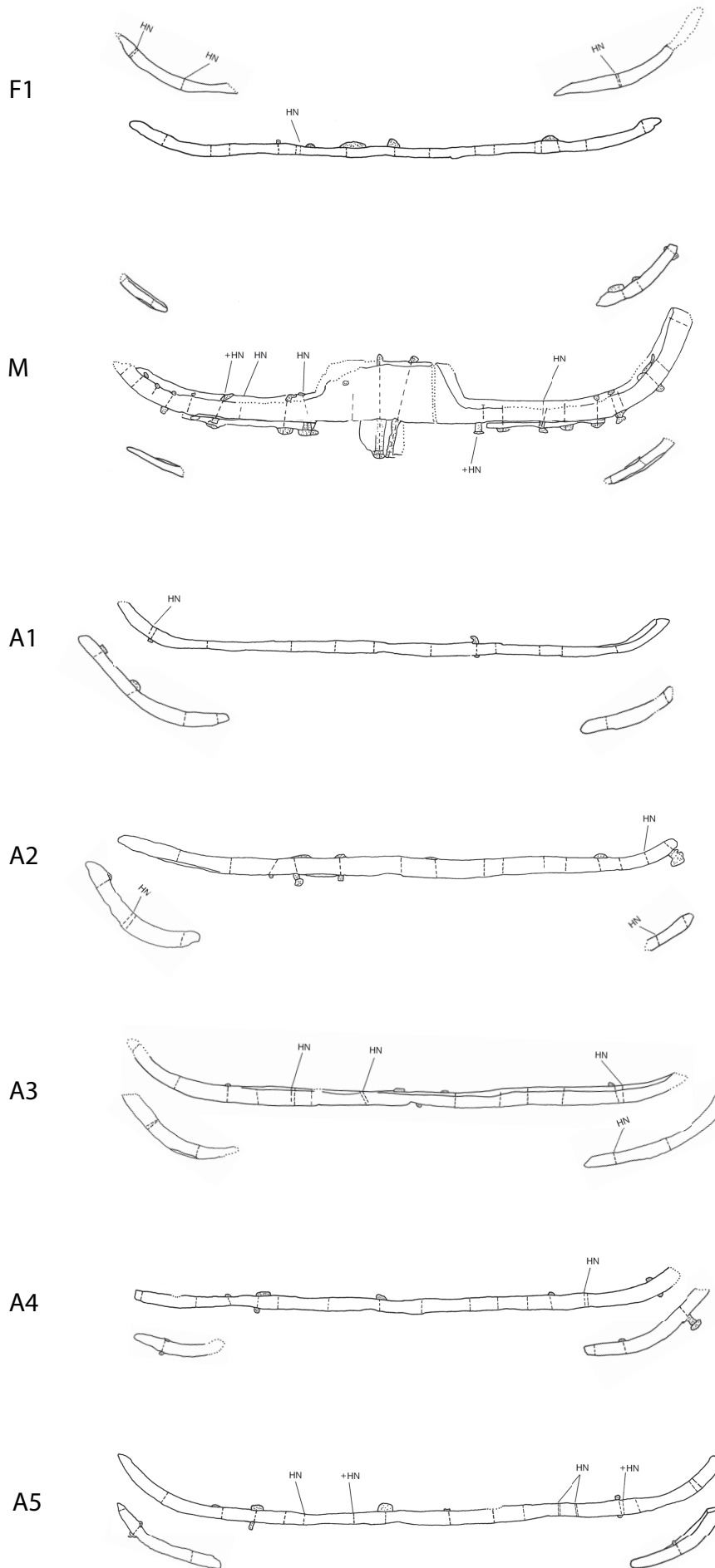
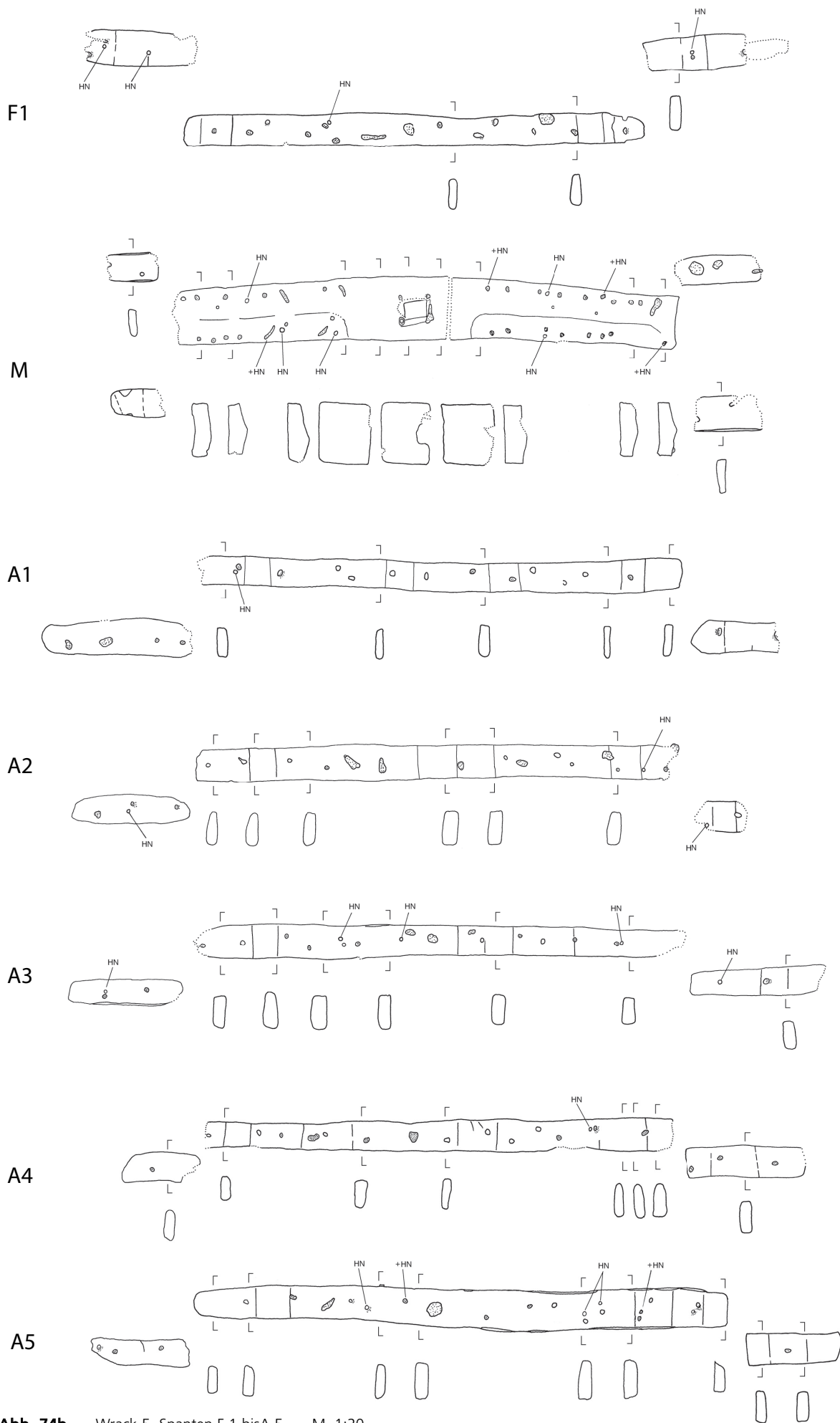

Abb. 74b. – Wrack 5. Spanten F 1 bis A 5. – M. 1:20.