

Bergkamen-Oberaden. Gebäudegrundrisse 1-5. - M. 1:100.

TAFEL 2

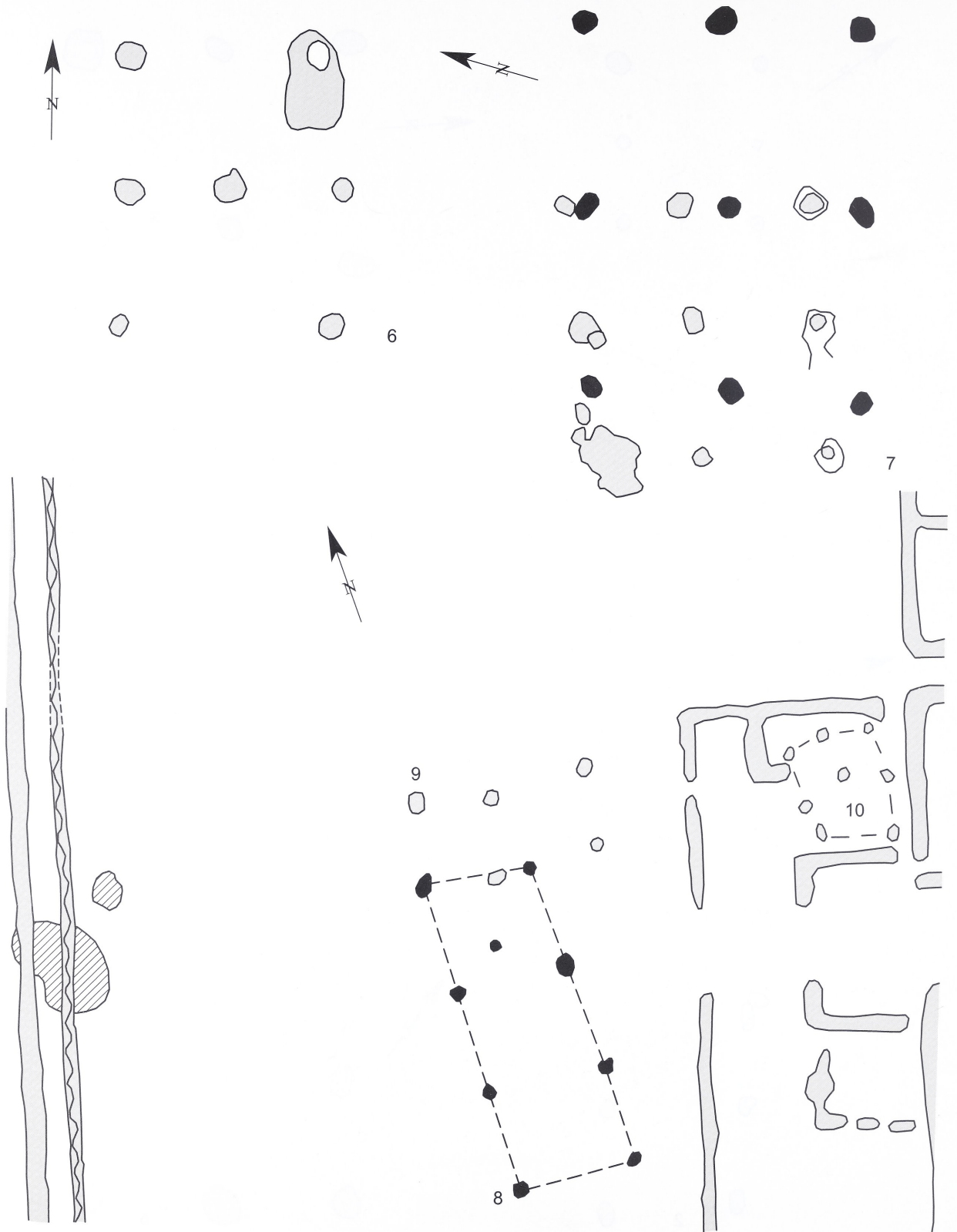

Bergkamen-Oberaden. Gebäudegrundrisse 6, 7, 8-10. - M. 1:100.

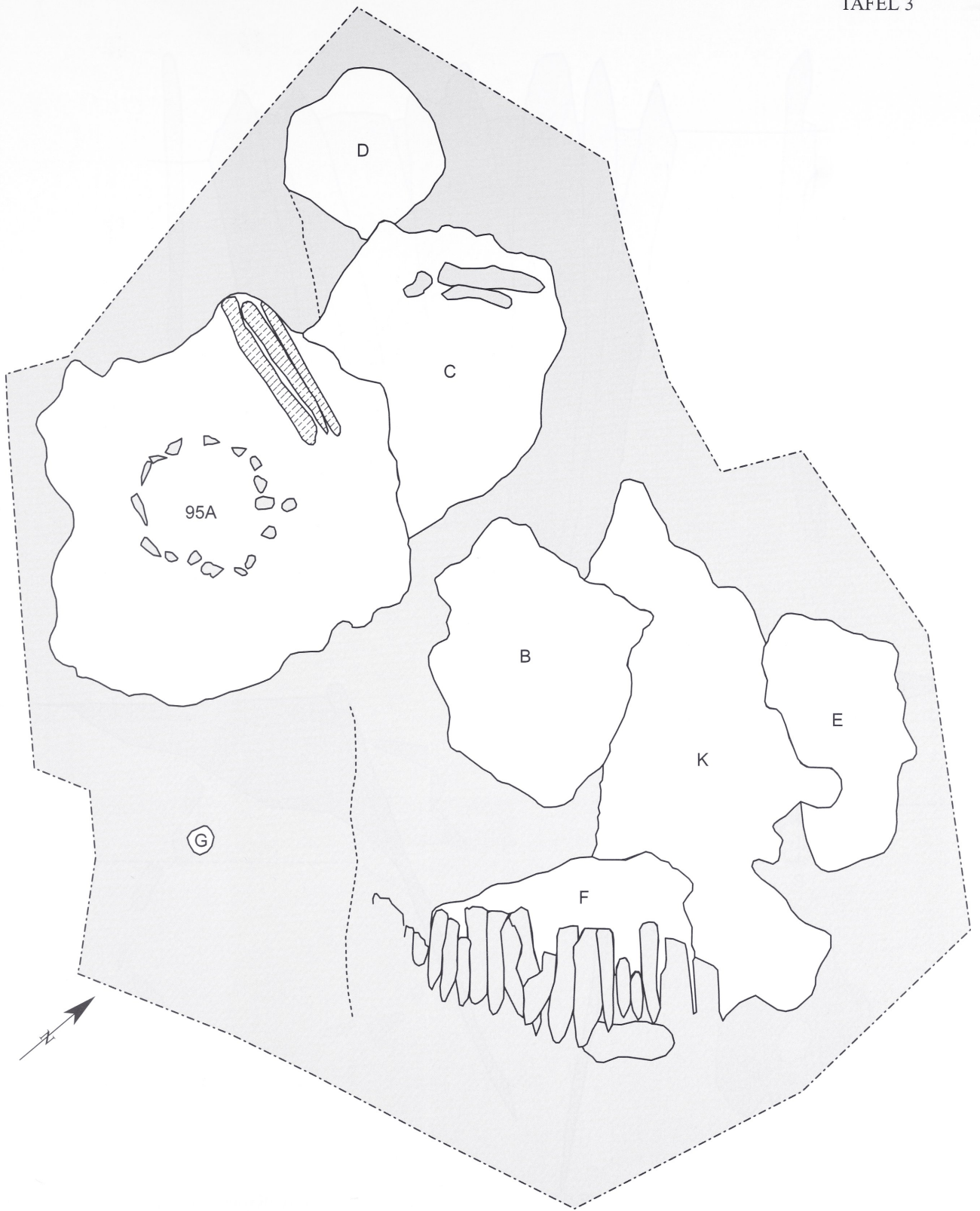

Bergkamen-Oberaden. Bef. 95/1979, Detailplanum (gestrichelte Linie = Unnaer Spannung). - M. 1:50.

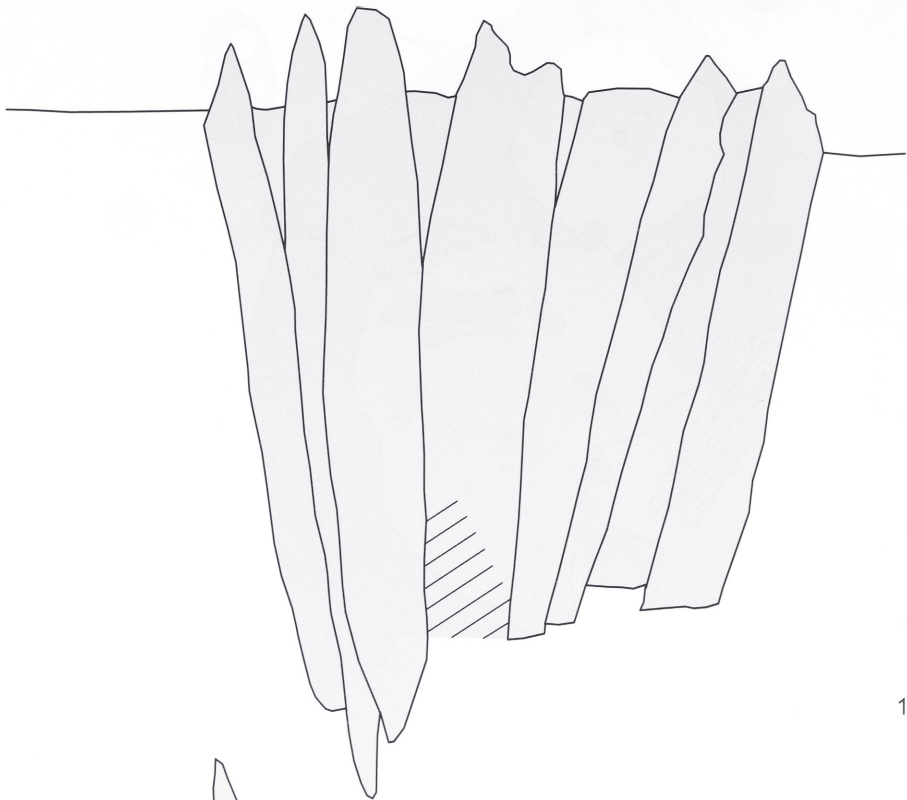

1

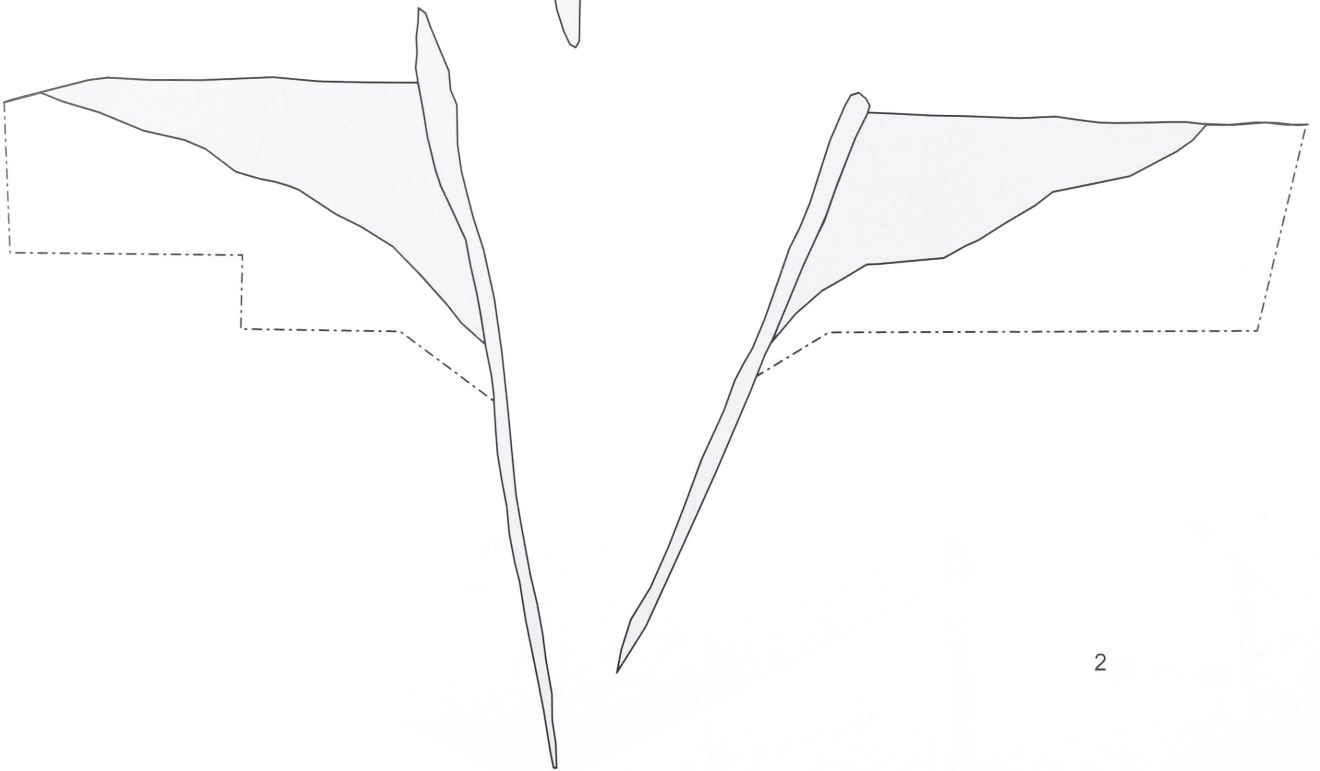

2

Bergkamen-Oberaden. 1.Bef. 95A/1979, Seitenansicht der Holzverschalung, Blick von Süd; 2.Bef. 95A, Profilschnitt, Blick von Süd. - M. 1:100.

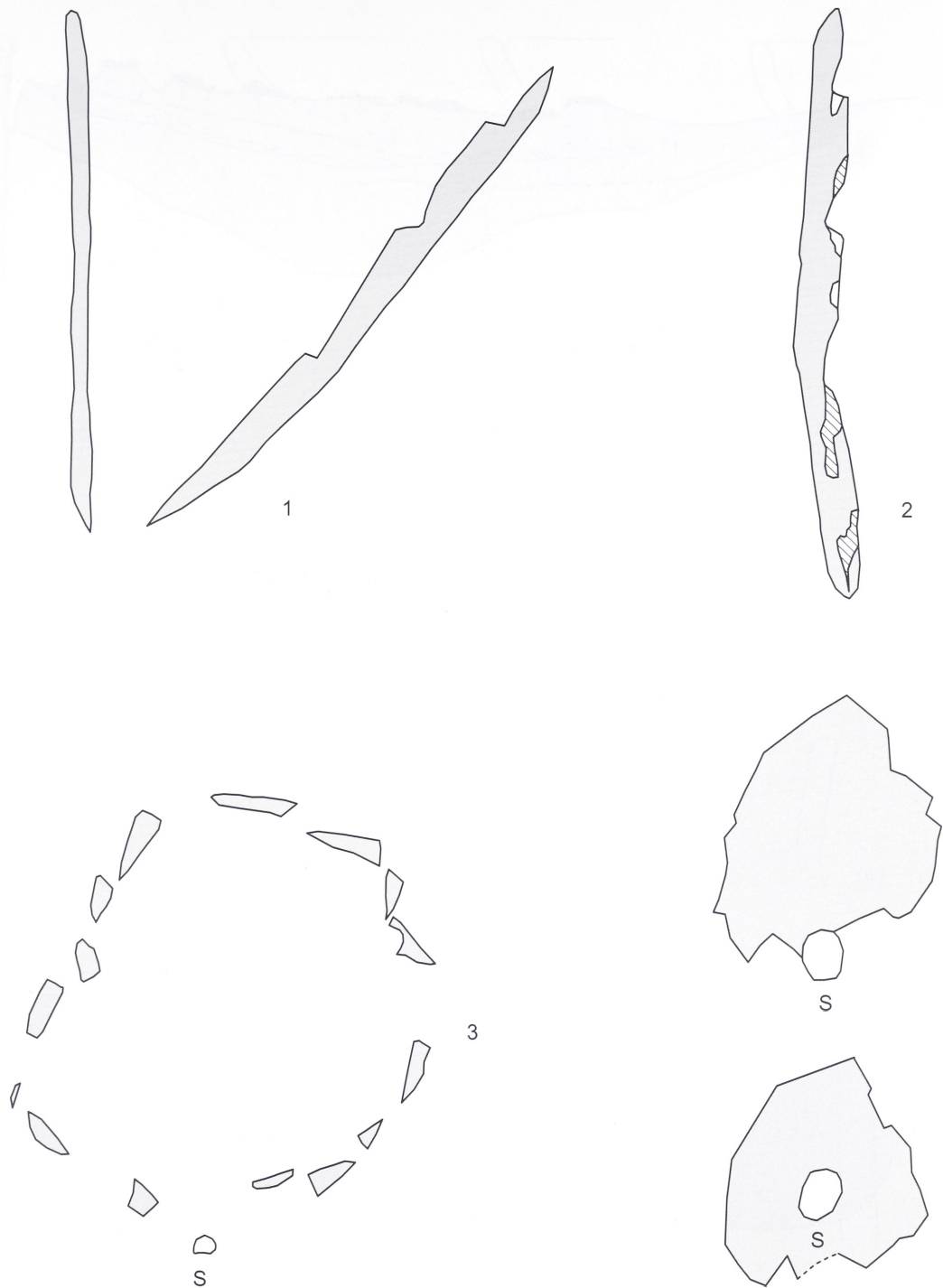

Bergkamen-Oberaden. 1. Bef. 95A/1979, Position des Steigbaums im Brunnenschacht, Blick von West; 2. Bef. 95A/1979, Steigbaum, stellenweise fehlende Rinde (Schraffur); F3. Bef. 95A/1979, Querschnitt des Brunnenschachtes auf 61,33 m ü. NN (a), 60,43 m ü. NN (b) und 59,93 m ü. NN (c), S = Steigbaum. - M. 1:20.

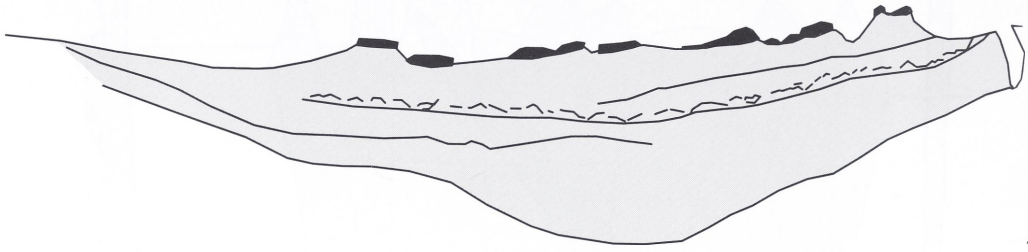

1

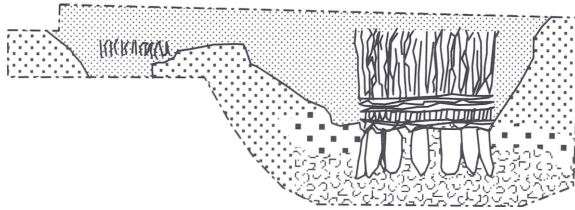

2

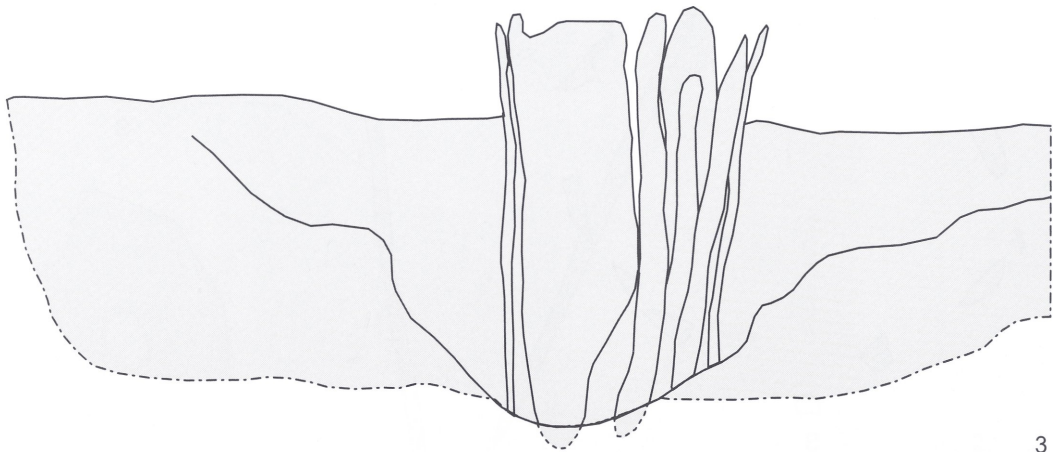

3

Bergkamen-Oberaden. 1. Bef. 95F/1979, Profil, Blick von Nord; F2. Bef. 80A/B, Profil, Blick von Süd; 3. Bef. 207A, Profil, Blick von Ost. - 1 M. 1:30; 2 M. 1:50; 3 M. 1:20.

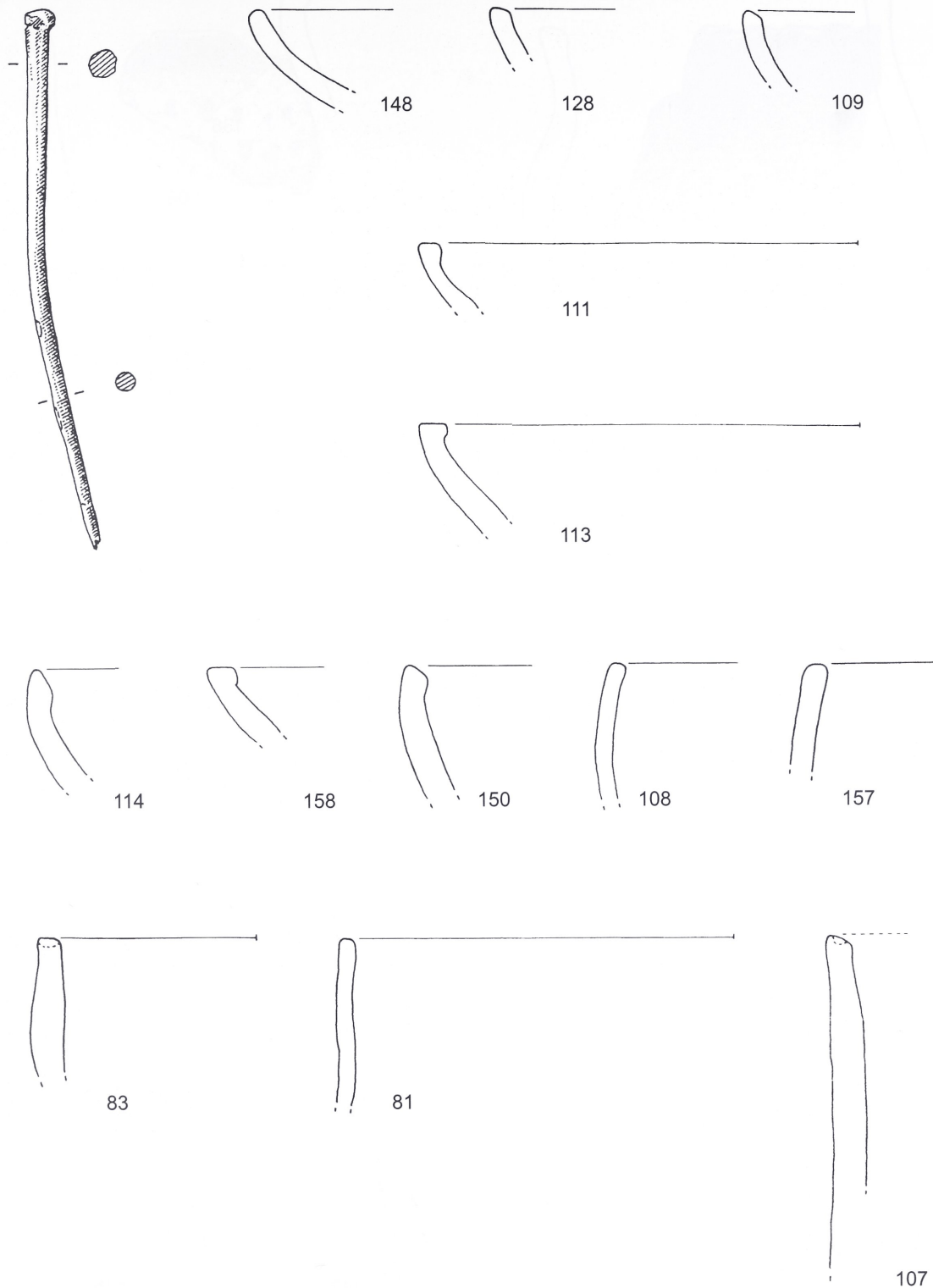

Bergkamen-Oberaden. Bef. 95/1979. - Keramik M. 1:2; Bronze M. 1:1.

TAFEL 8

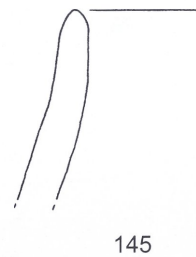
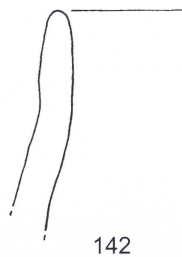
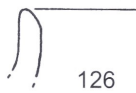
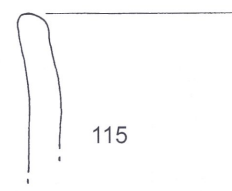
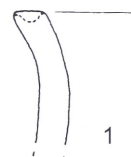
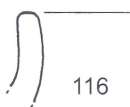
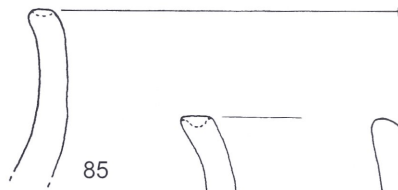
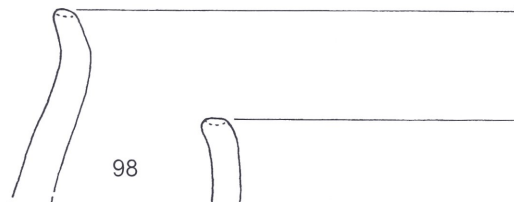
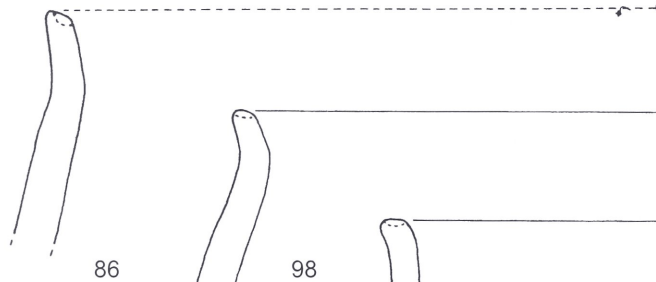
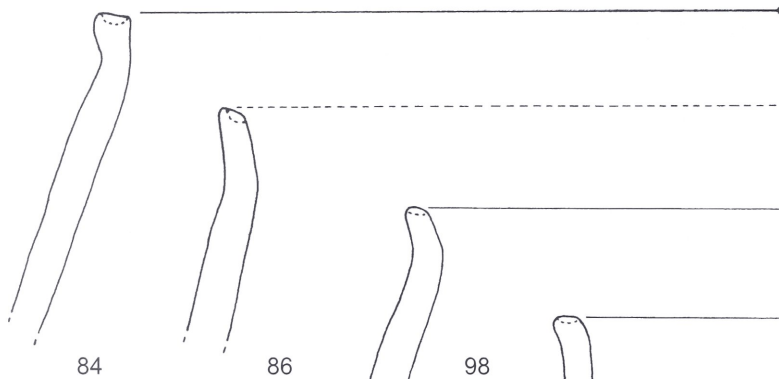
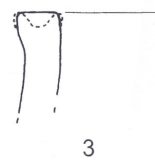
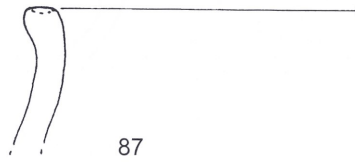
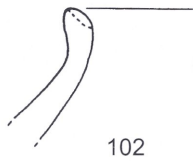
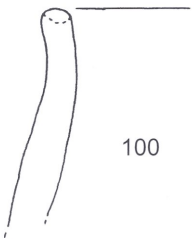
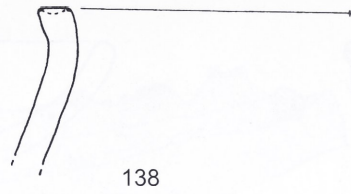
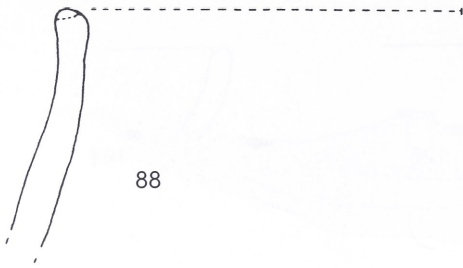



160

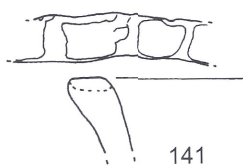

141

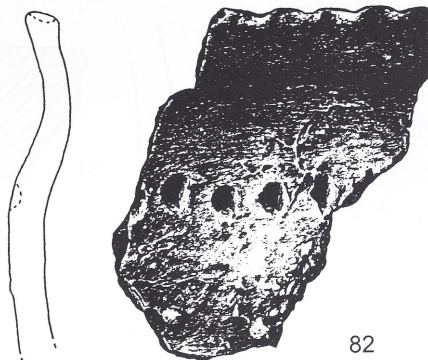

82

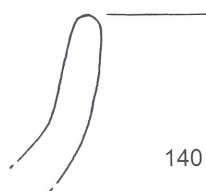

140

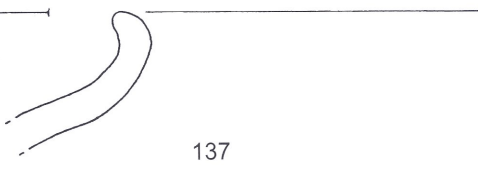

137

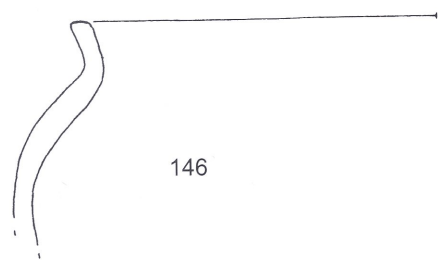

146

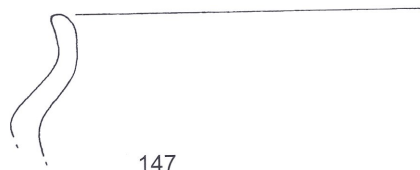

147

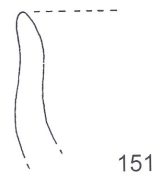

151

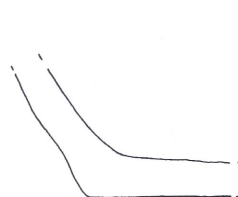

12

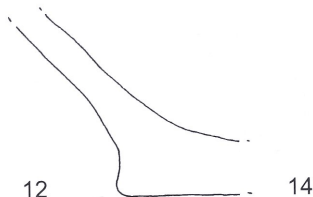

14

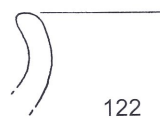

122



123

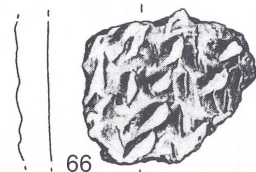
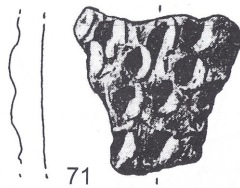
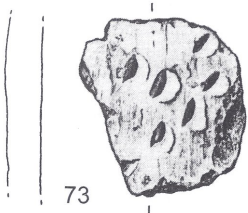
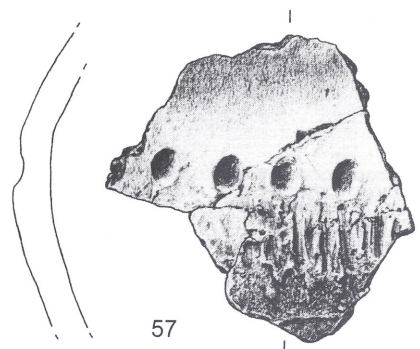
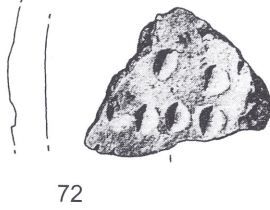
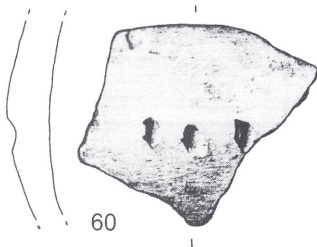
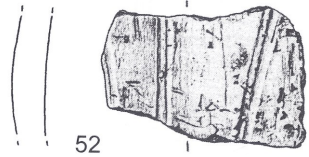
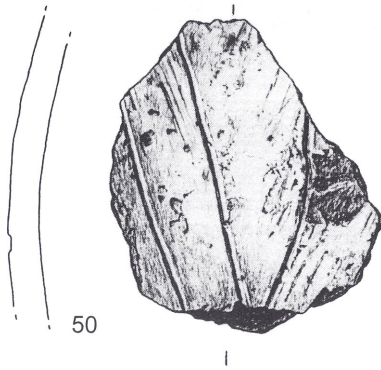
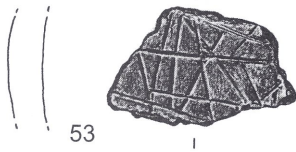
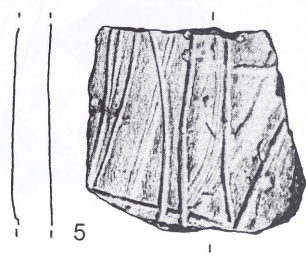
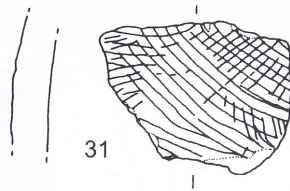
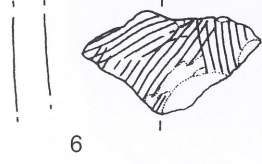

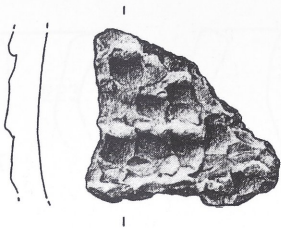

78

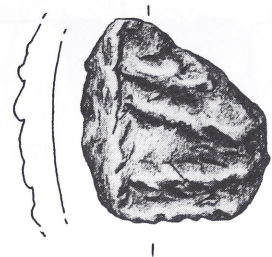

4

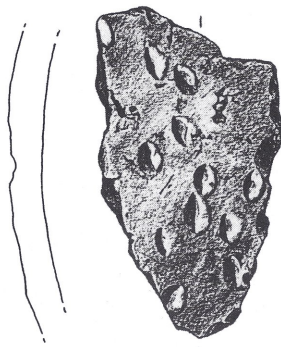

74

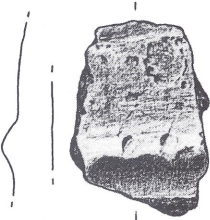

68

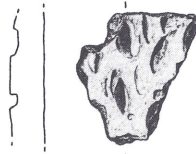

70

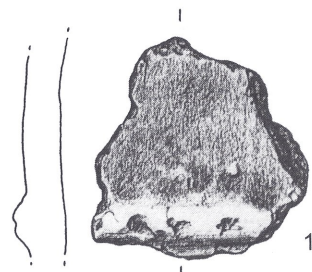

174

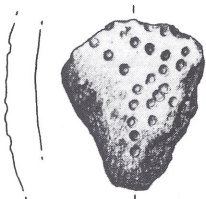

69

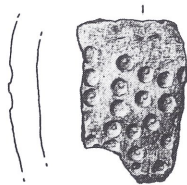

169

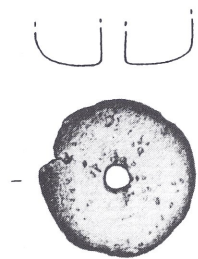

328

TAFEL 12

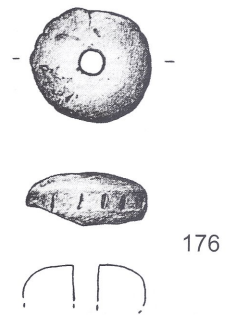
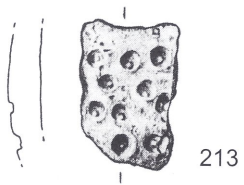
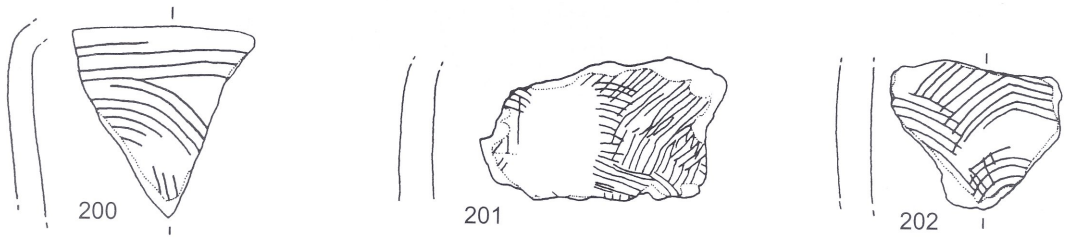
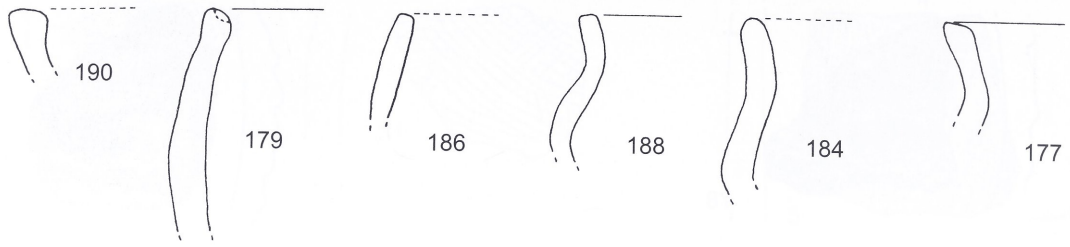

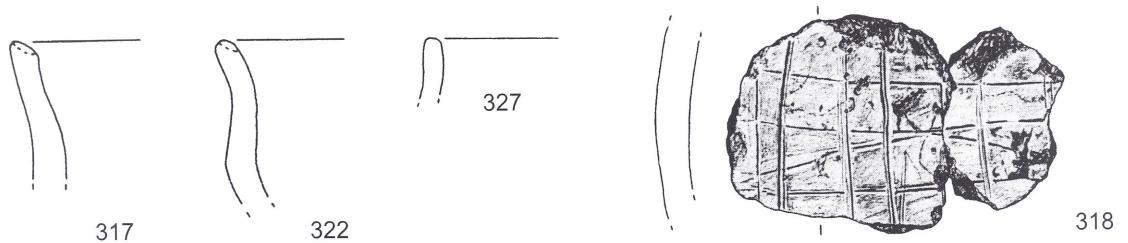
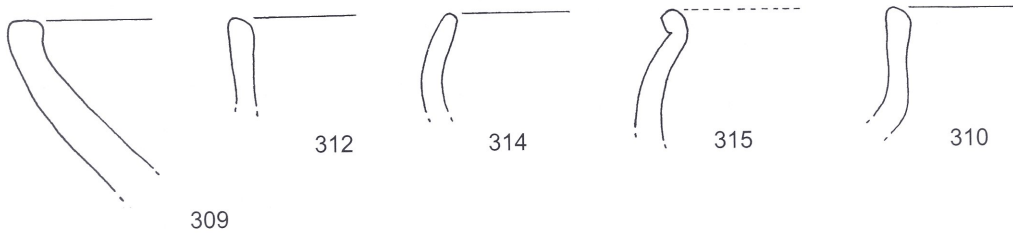
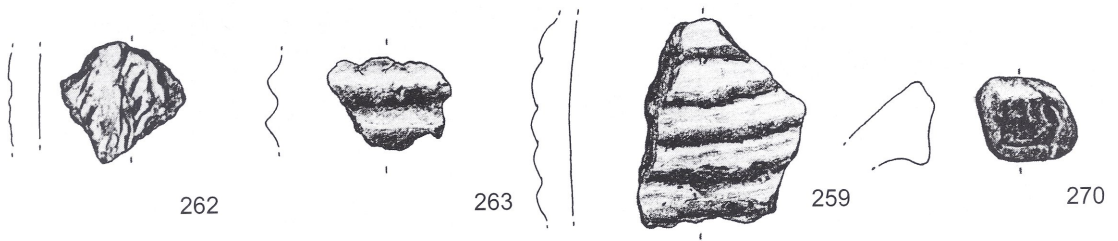
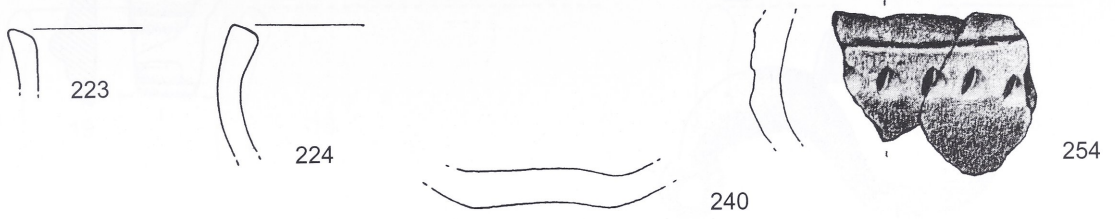

Bergkamen-Oberaden. Reihe 1 und 2 Bef. 95B/1979; Reihe 3 Bef. 95F/1979; Reihe 4 Bef. 95K/1979. - Keramik M. 1:2.

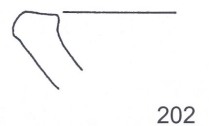
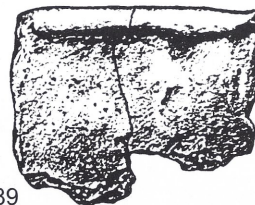
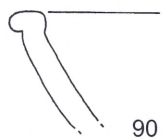
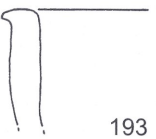
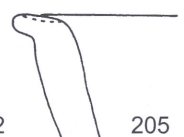
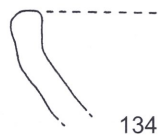
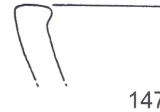
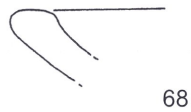
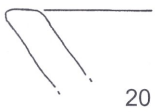
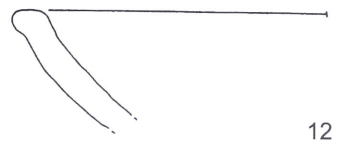
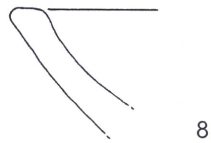
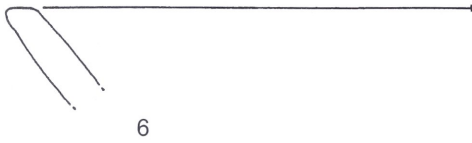
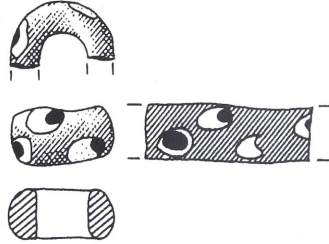
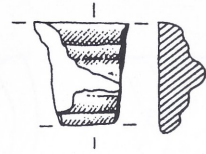
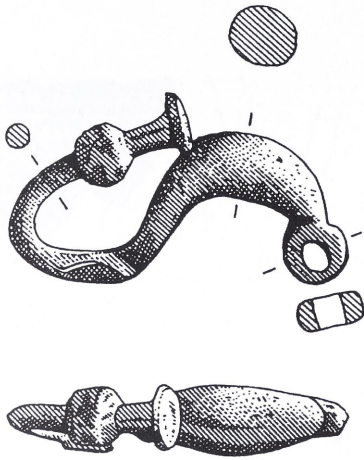

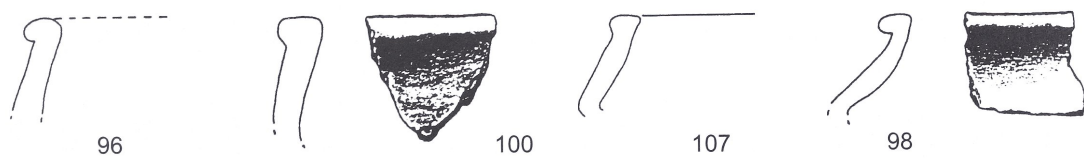
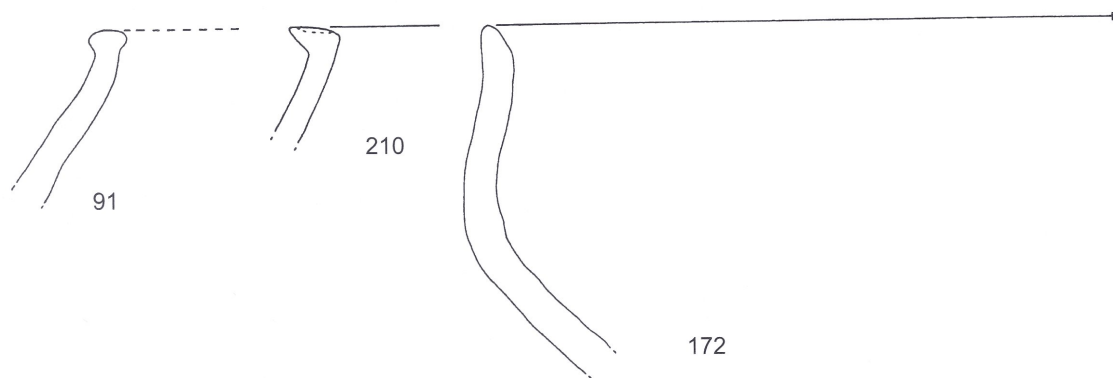
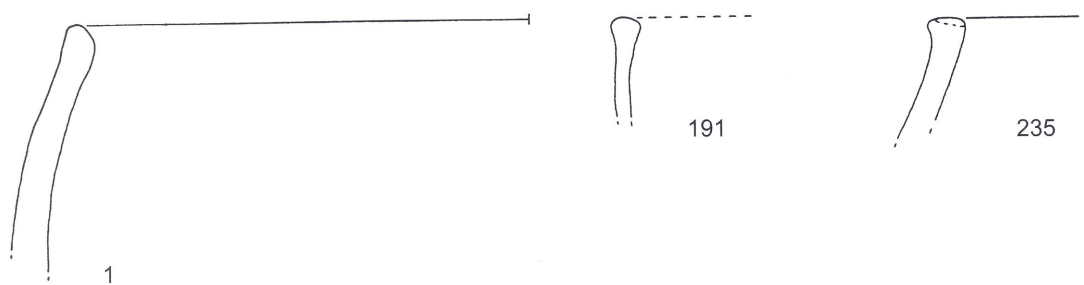

TAFEL 16

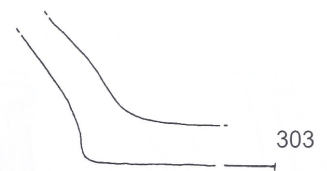
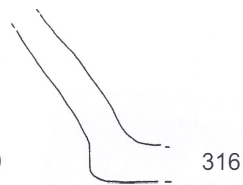
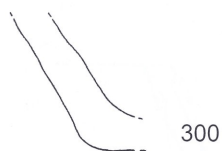
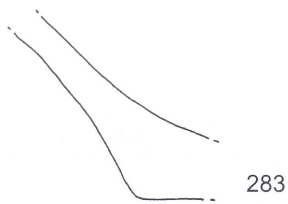
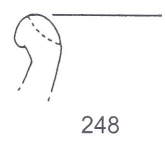
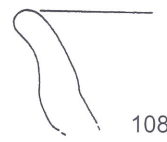
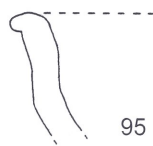
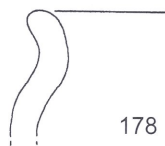
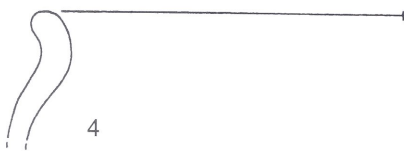
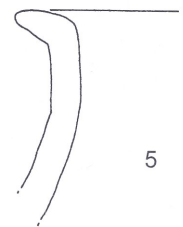
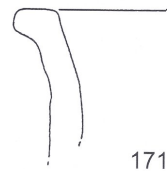
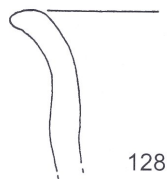
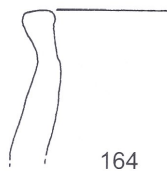
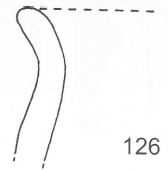
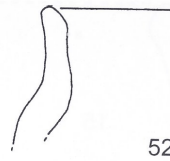
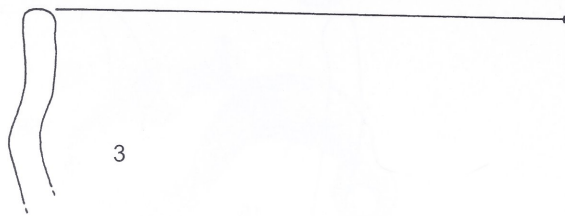

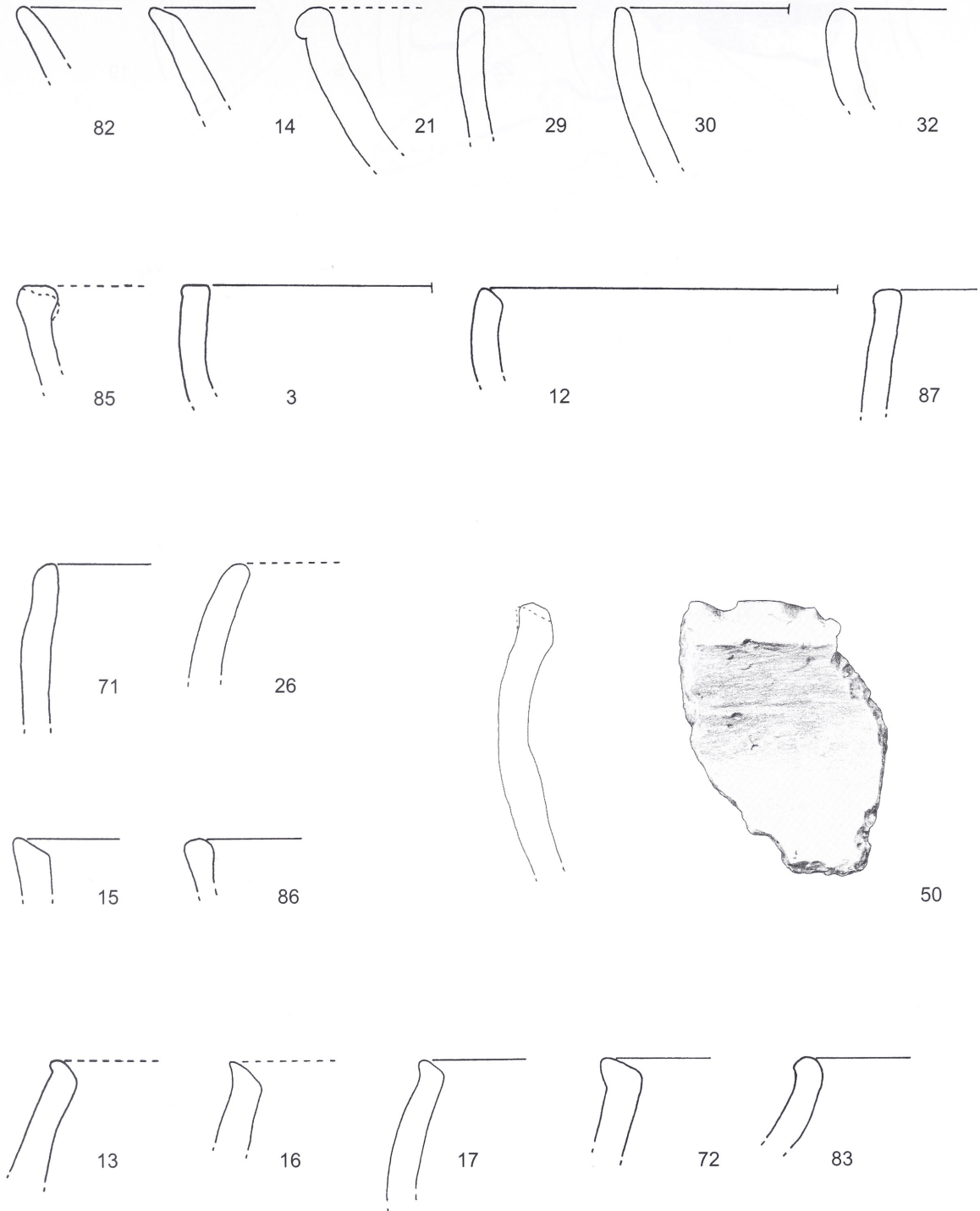

TAFEL 18

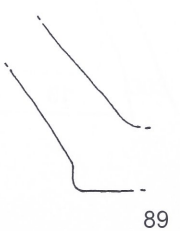
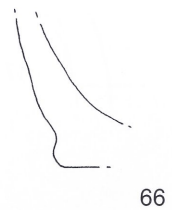
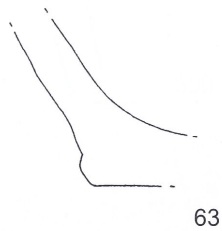
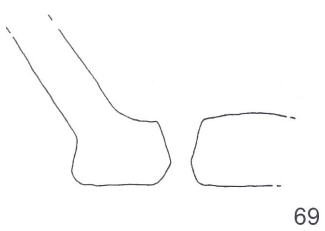
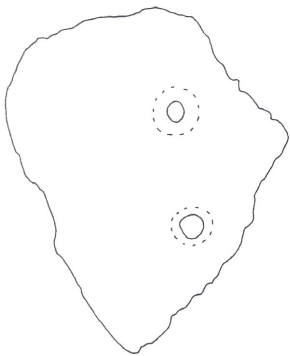
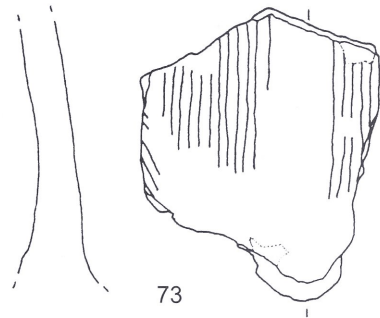
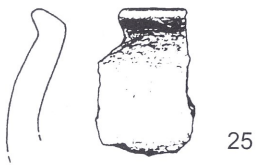
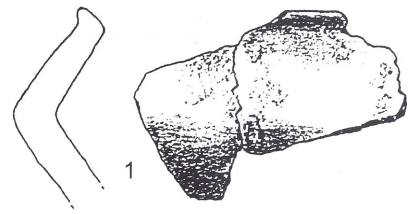
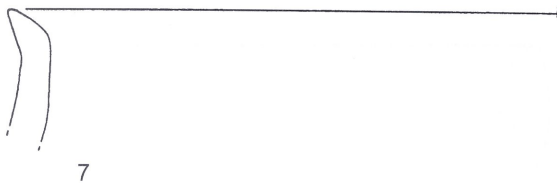
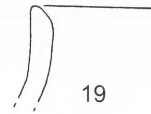
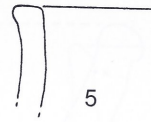
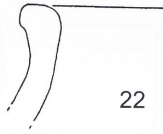

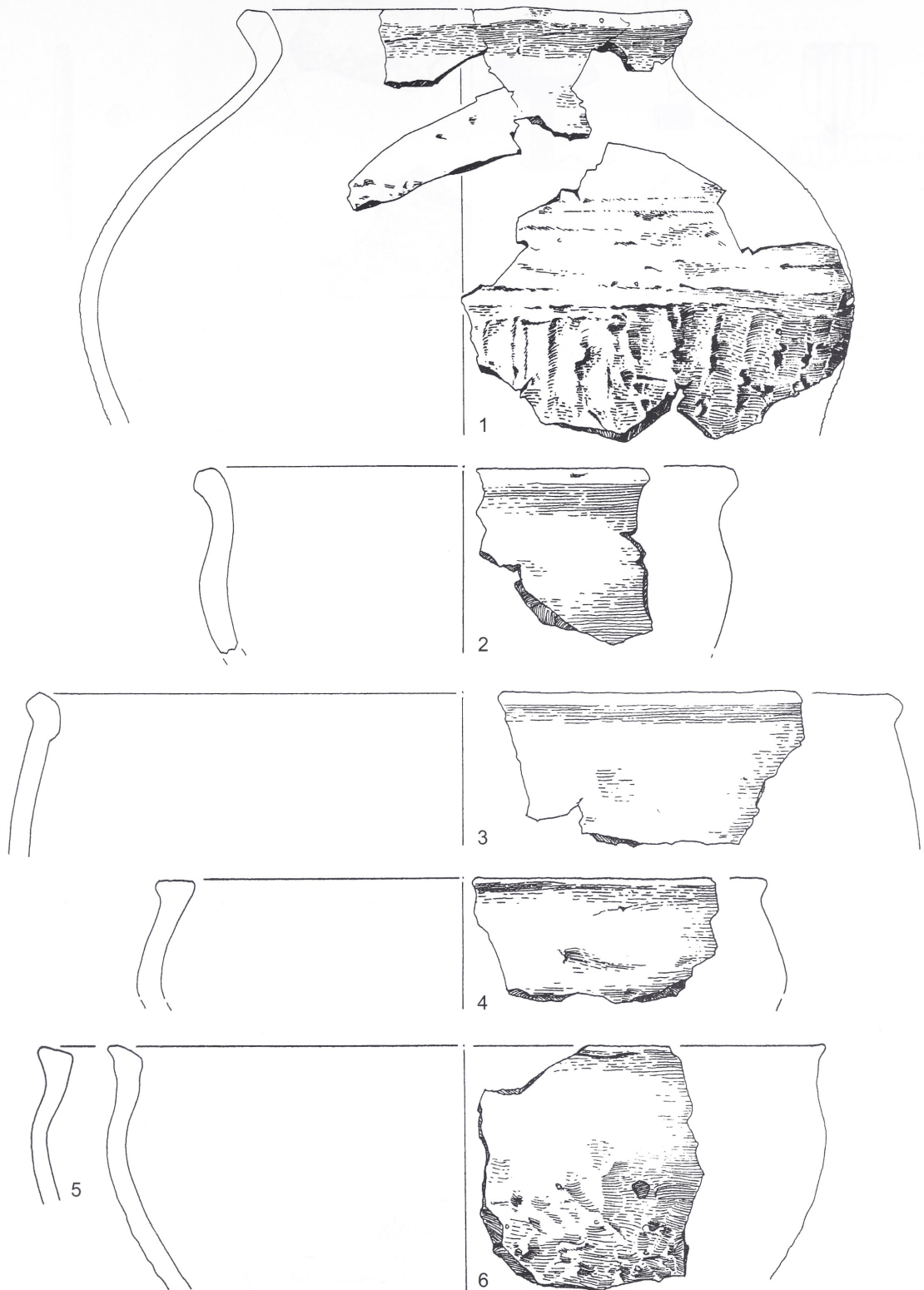

Bergkamen-Oberaden. Bef. 1/1980. - Keramik M. 1:3.

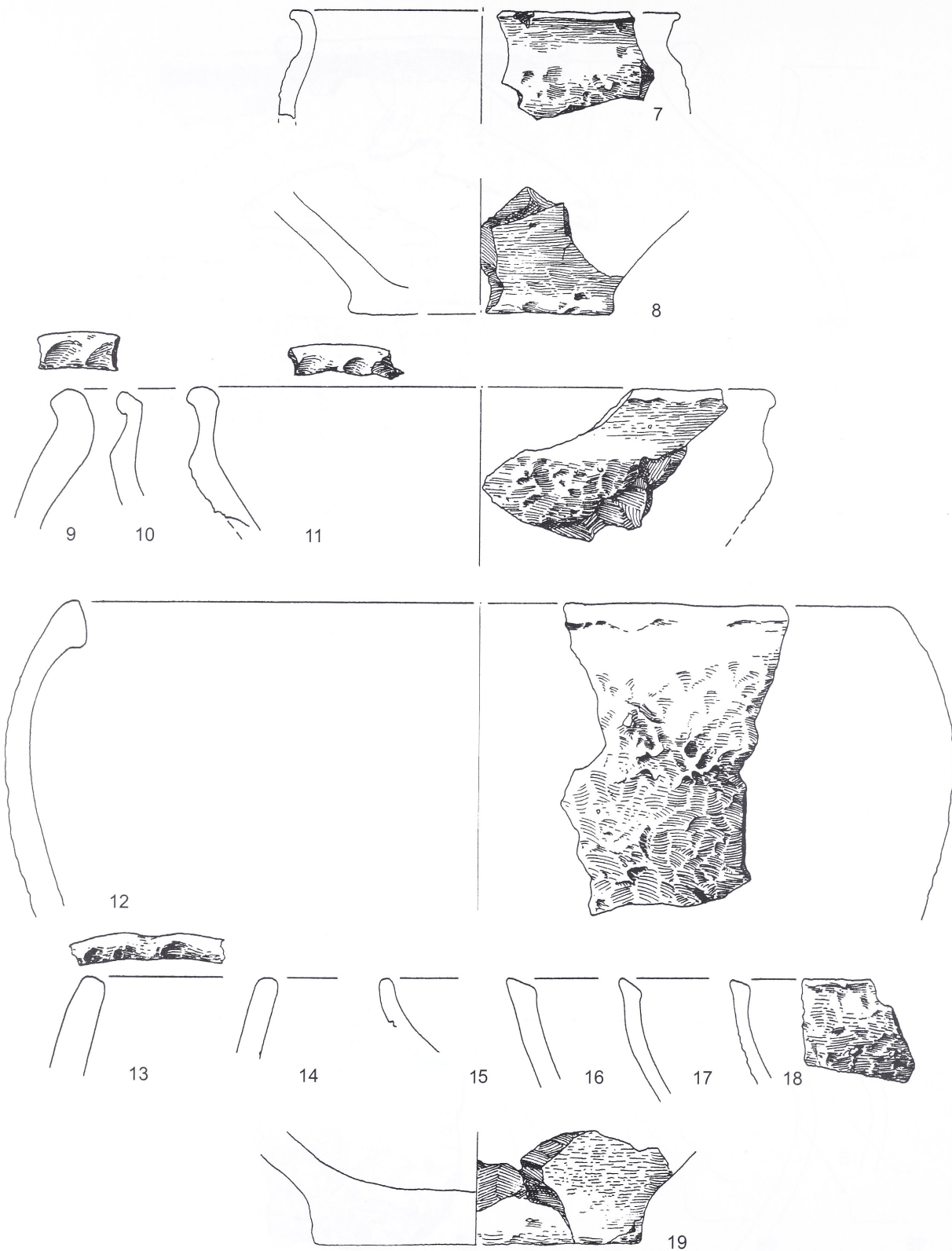

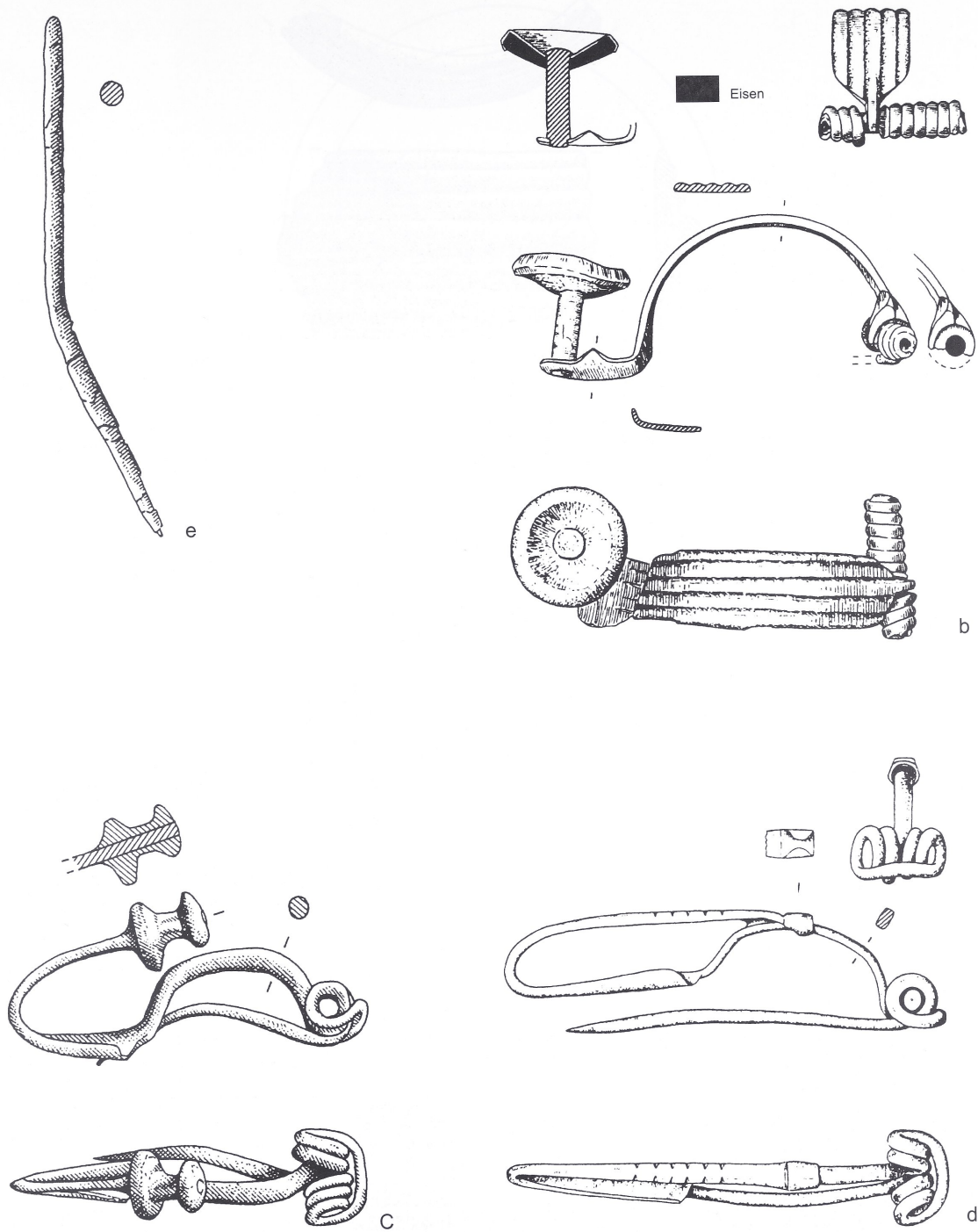

Bergkamen-Oberaden. Einzelfunde. - Bronze M. 1:1.

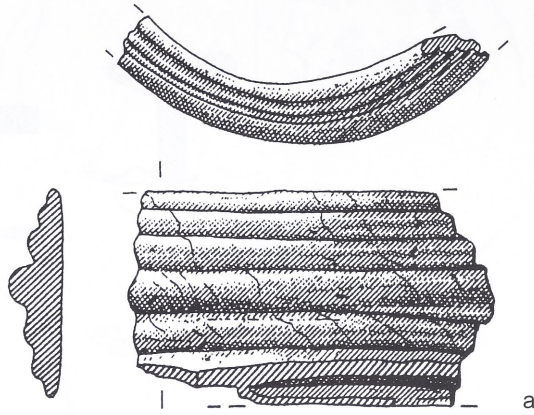

Schnitt ergänzt

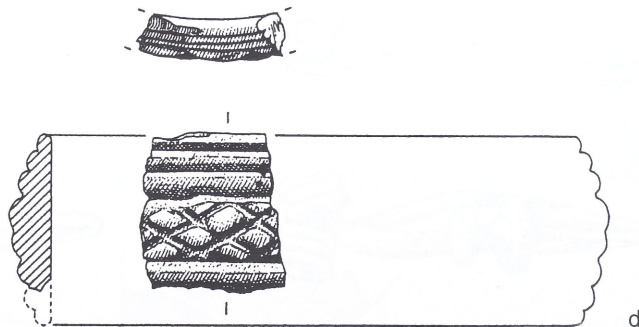
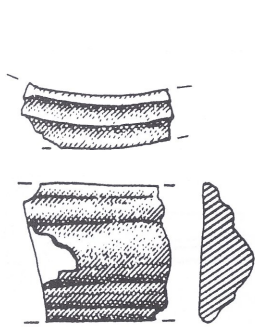
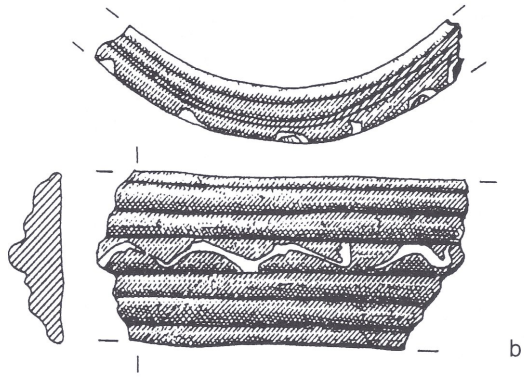

Bergkamen-Oberaden. Einzelfunde. - Glas M. 1:1.

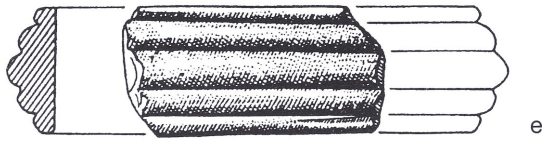
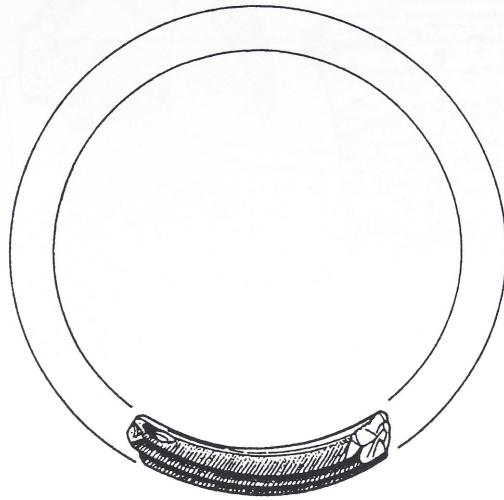

e



f



g



h



i

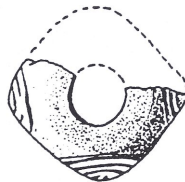

k



l

Bergkamen-Oberaden. Einzelfunde. - Glas M. 1:1.

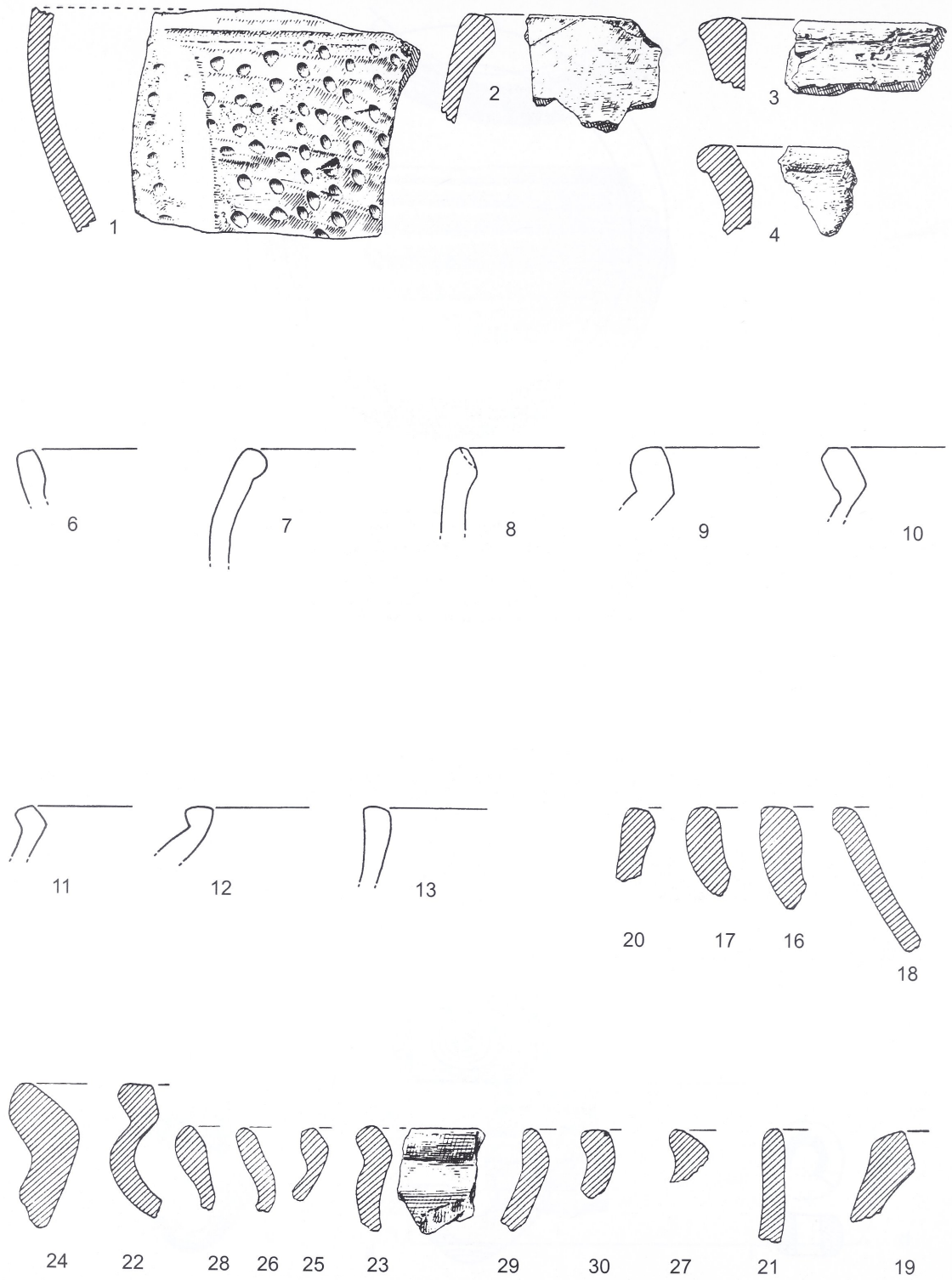

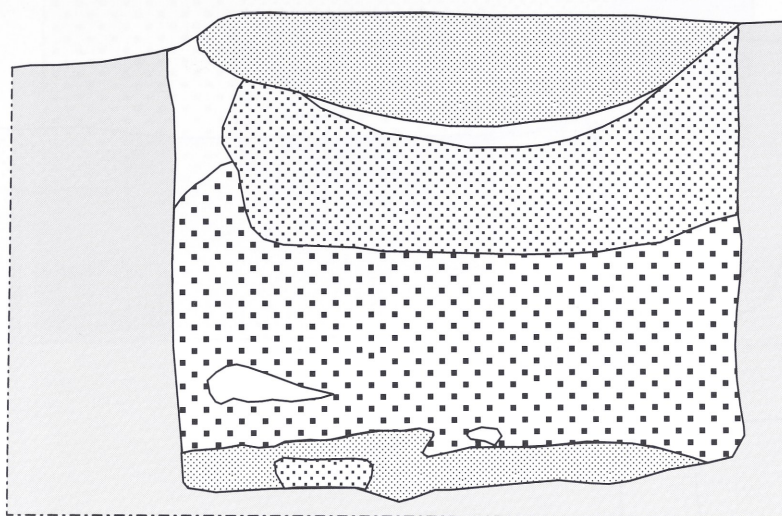

1

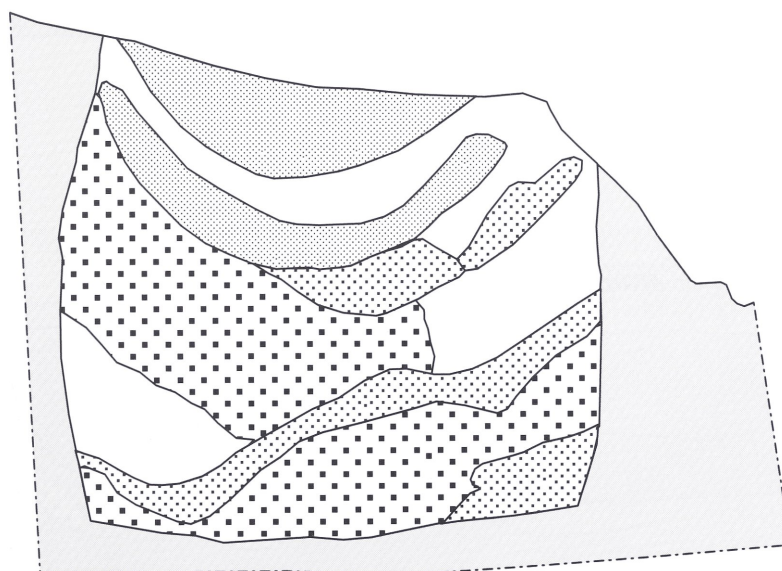

2

Delbrück-Anreppen (Dkz. 4217,37). 1.Grube 9/1969, Profil; 2.Grube 10/1969, Profil. - M. 1:20.

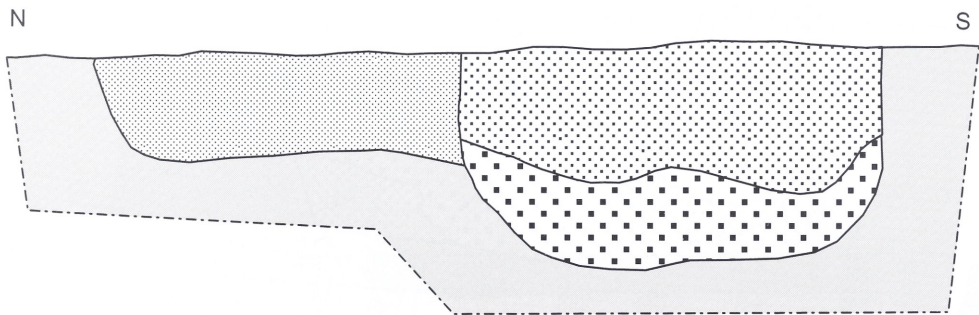
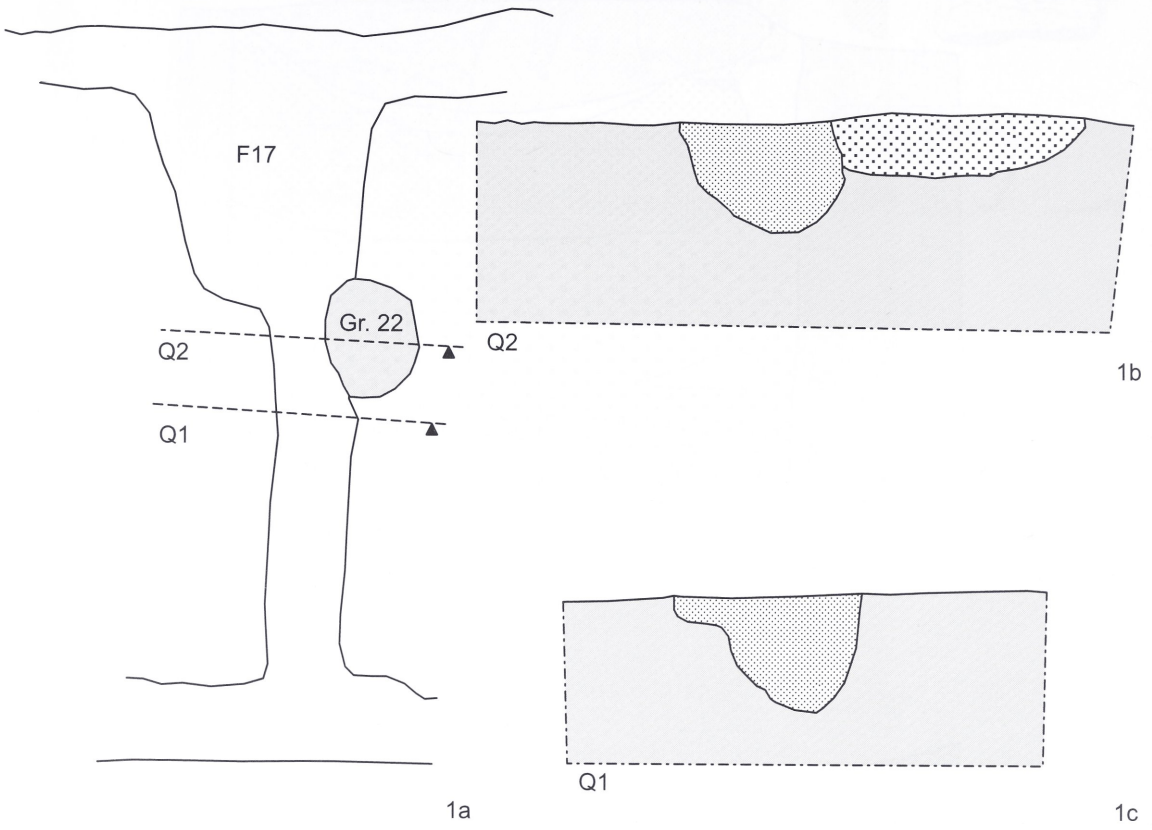

Delbrück-Anreppen (Dkz. 4217,37). Gr. 22 und F 17/1992, Aufsicht; 1b. Profil Q1;
1c. Profil Q2; 2. Gr. 138 (dunkel) und 138A/1995, Profil. 1a. M. 1:50; 1b-2 M. 1:20.

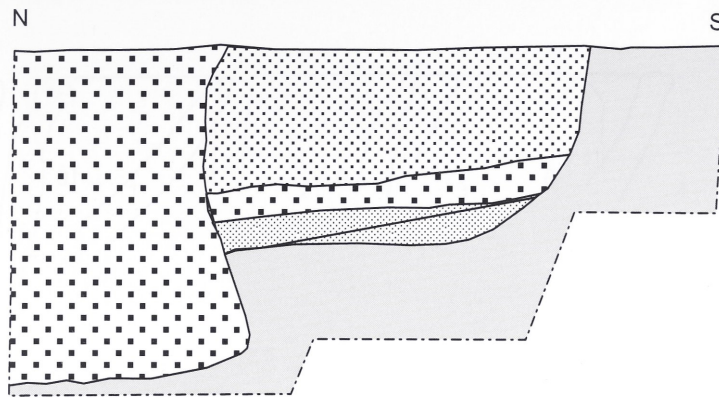

1

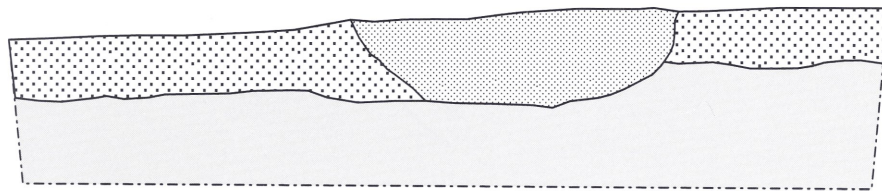

2a

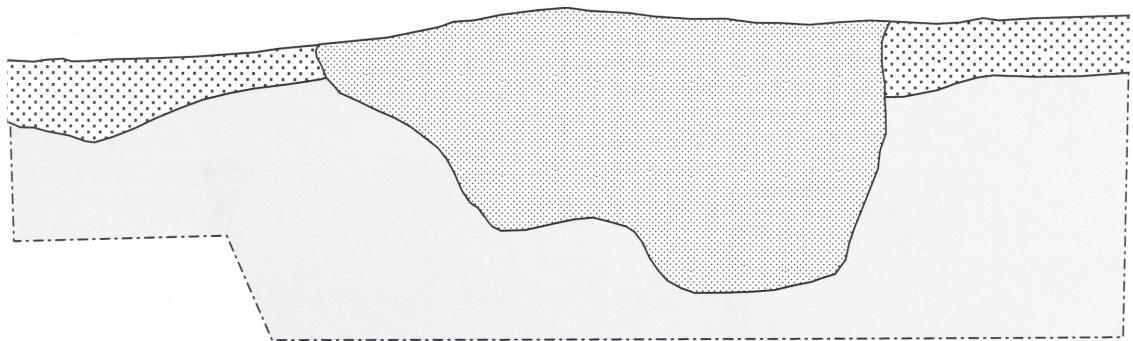

2b

*Delbrück-Anreppen (Dkz. 4217,37). 1. Grube 698A (hell) und 698B/1995, Profil;
2a. Gr. 55/1992, Profil; 2b. Gr. 56/1992, Profil. - M. 1:20.*

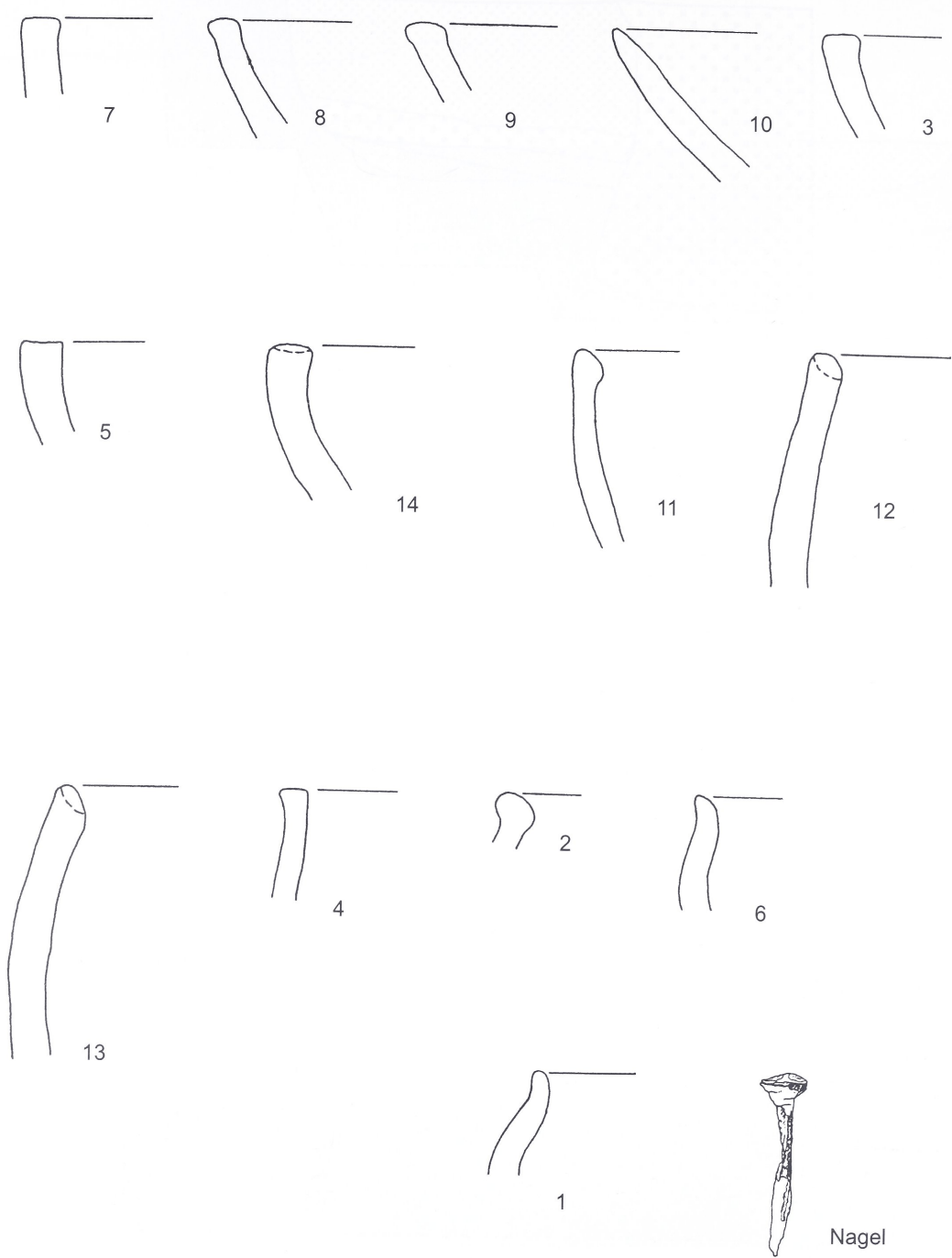

Delbrück-Anreppen (Dkz. 4217,37). Gr. 7/1969. - Keramik M. 1:2.

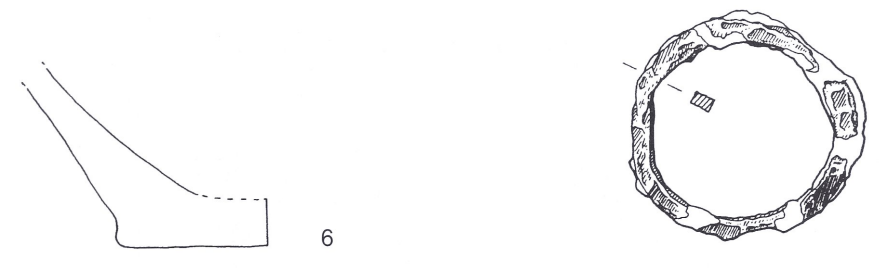
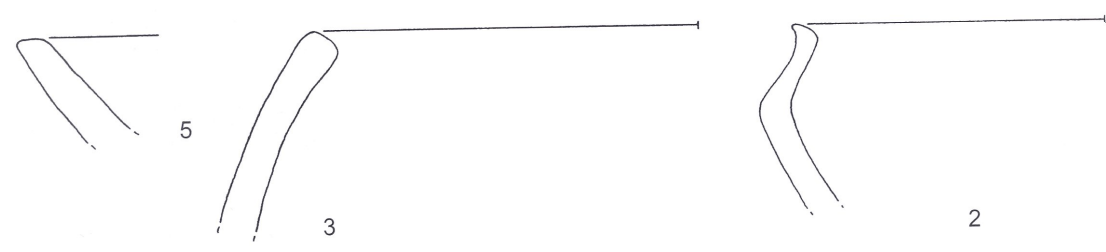
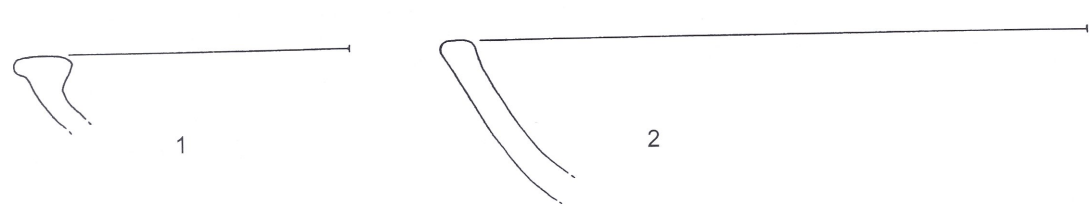
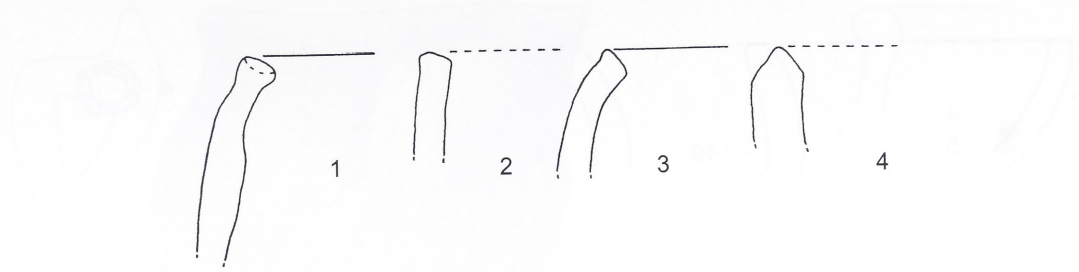

Delbrück-Anreppen (Dkz. 4217,37). Reihe 1 Gr. 3/1968; übrige Gr. 9/1969. - Eisen, Keramik M. 1:2.

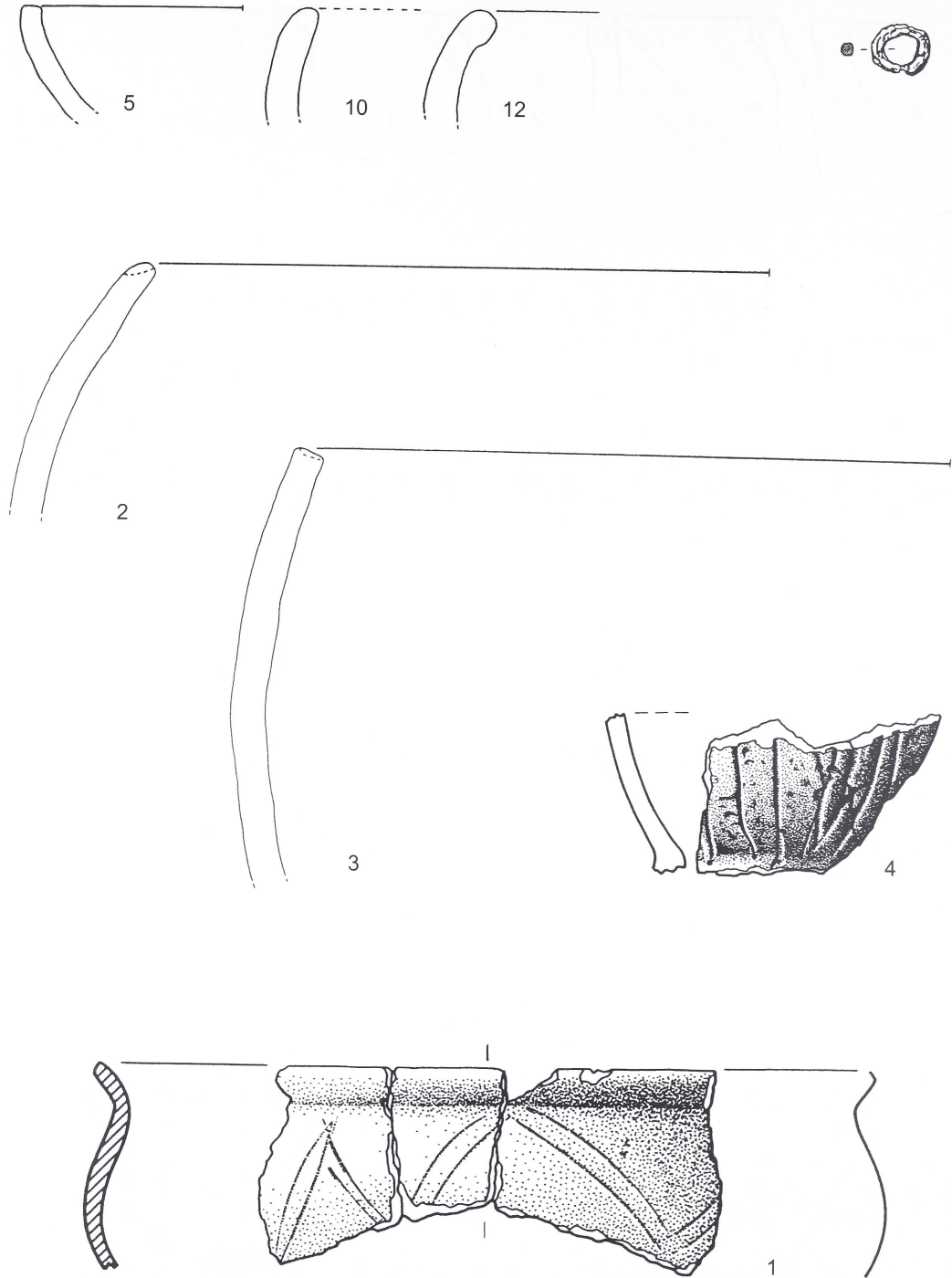

Delbrück-Anreppen (Dkz. 4217,37). Gr. 10/1969. - Eisen M. 1:1. Keramik M. 1:2.

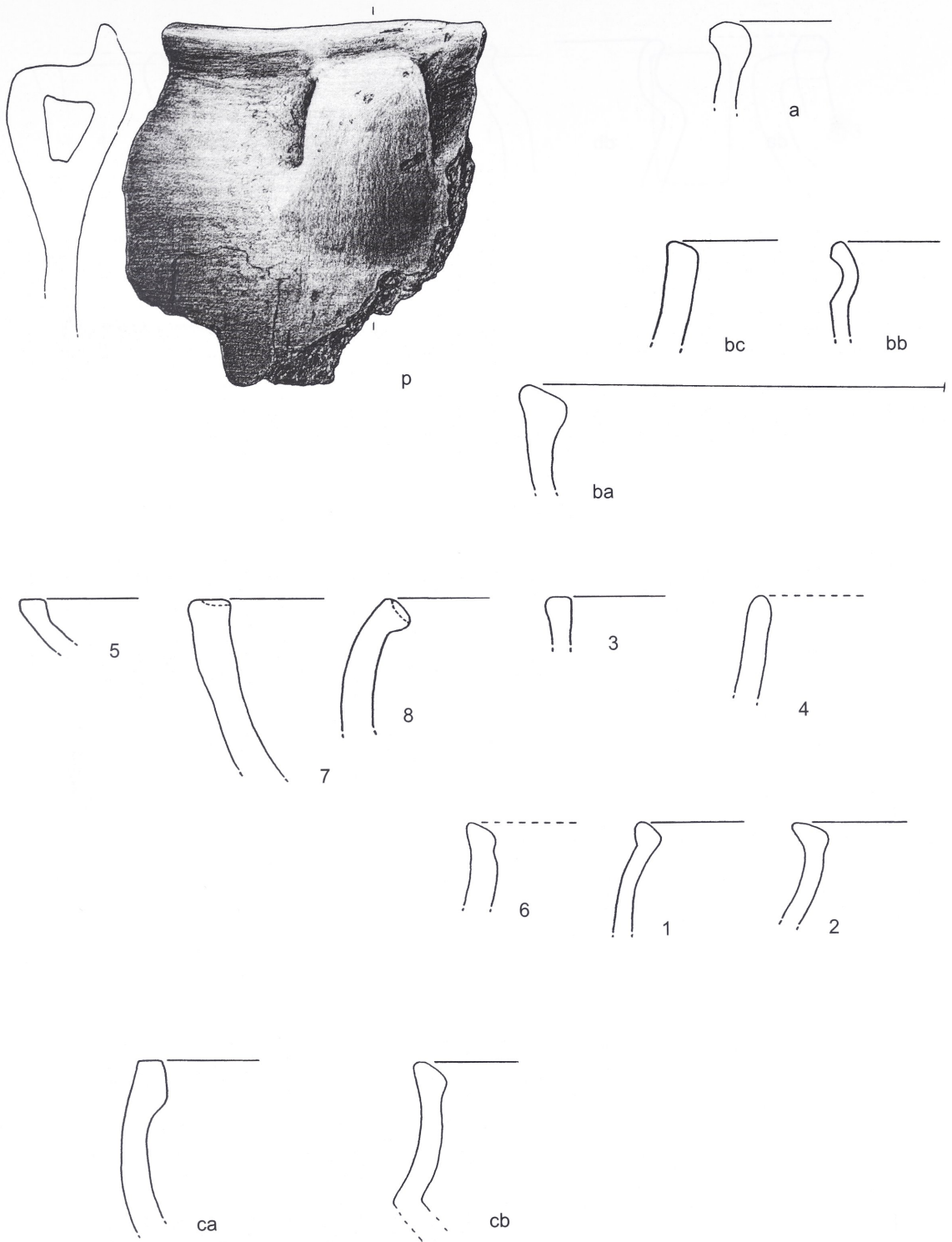

Delbrück-Anreppen (Dkz. 4217,37). Reihe 1 bis 4 Streufunde; übrige Gr. 25/1969. - M. 1:2.

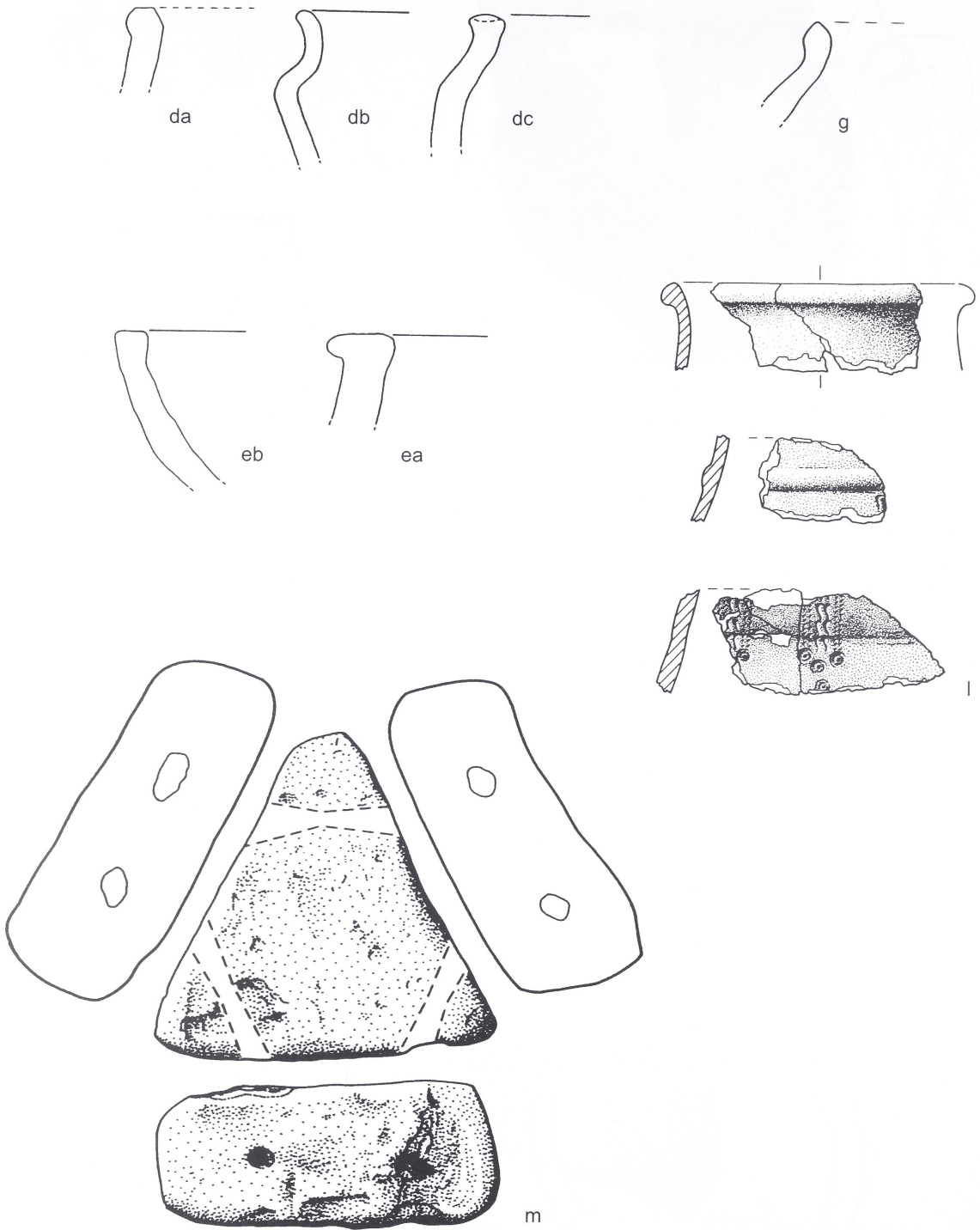

Delbrück-Anreppen (Dkz. 4217,37). Einzelfunde. - Keramik M. 1:2.

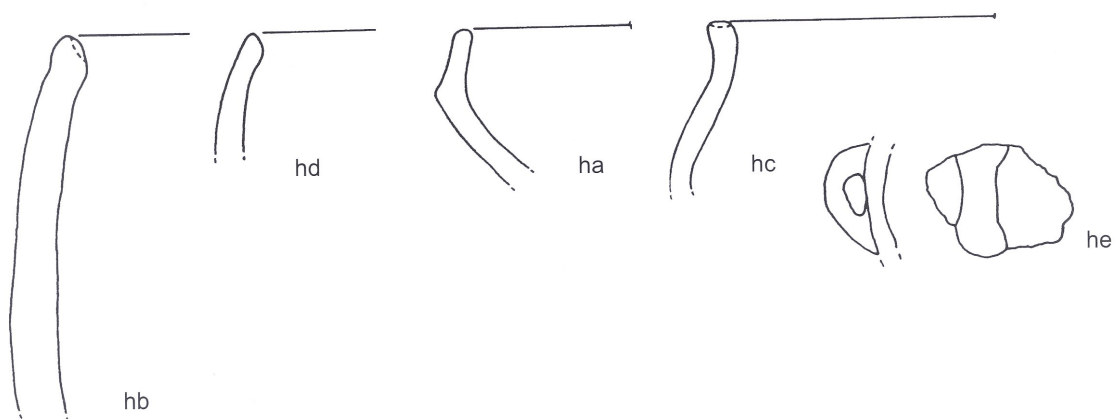
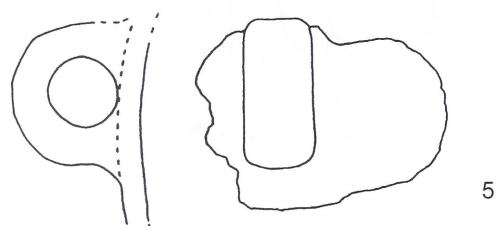
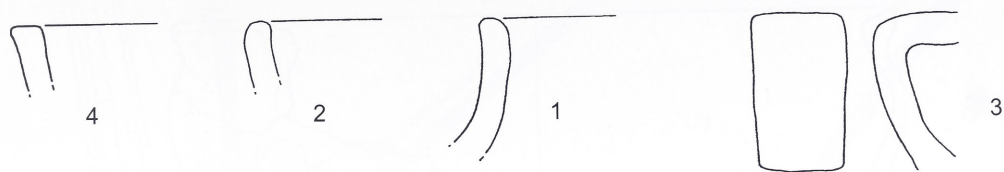

Delbrück-Anreppen (Dkz. 4217,37). Einzelfunde. - Keramik M. 1:2.

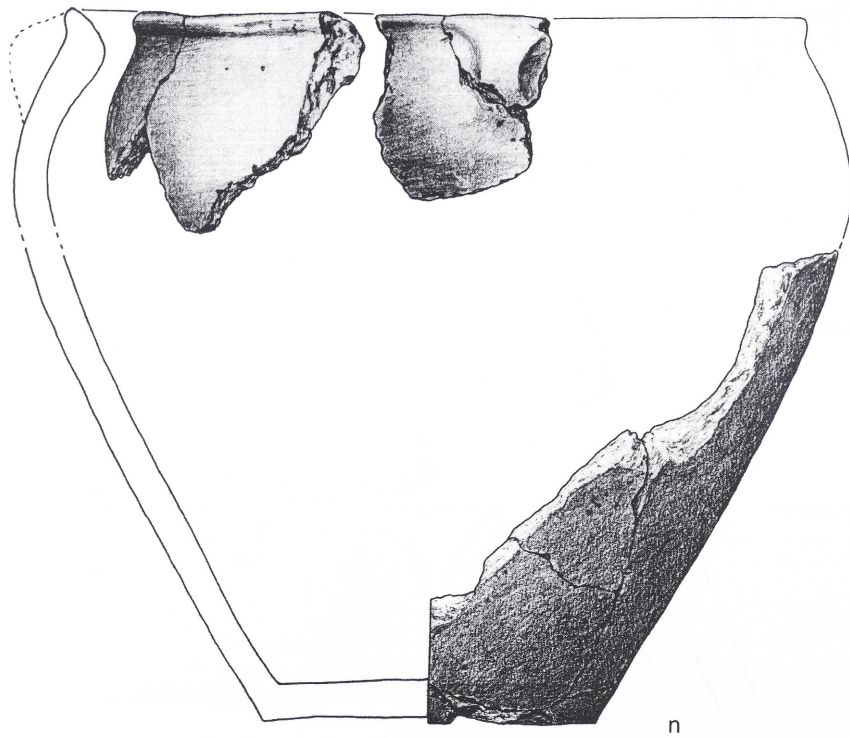
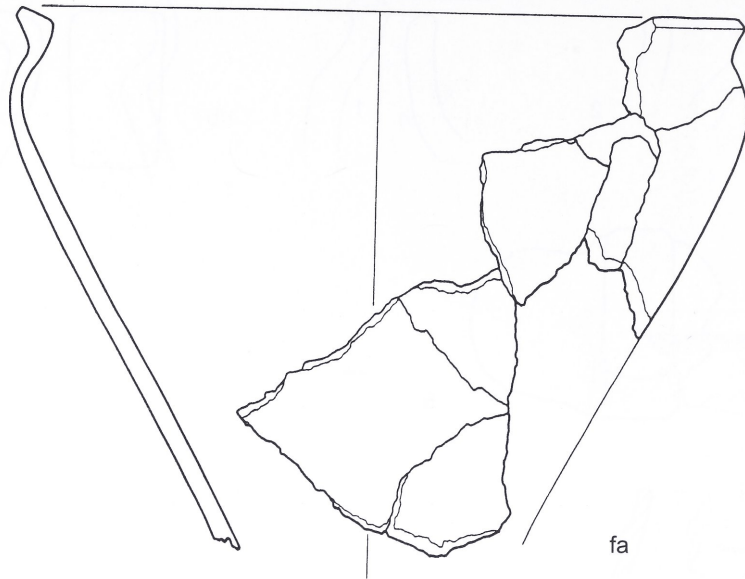

Delbrück-Anreppen (Dkz. 4217,37). Einheimische Keramik aus römischen Befunden. - M. 1:2.

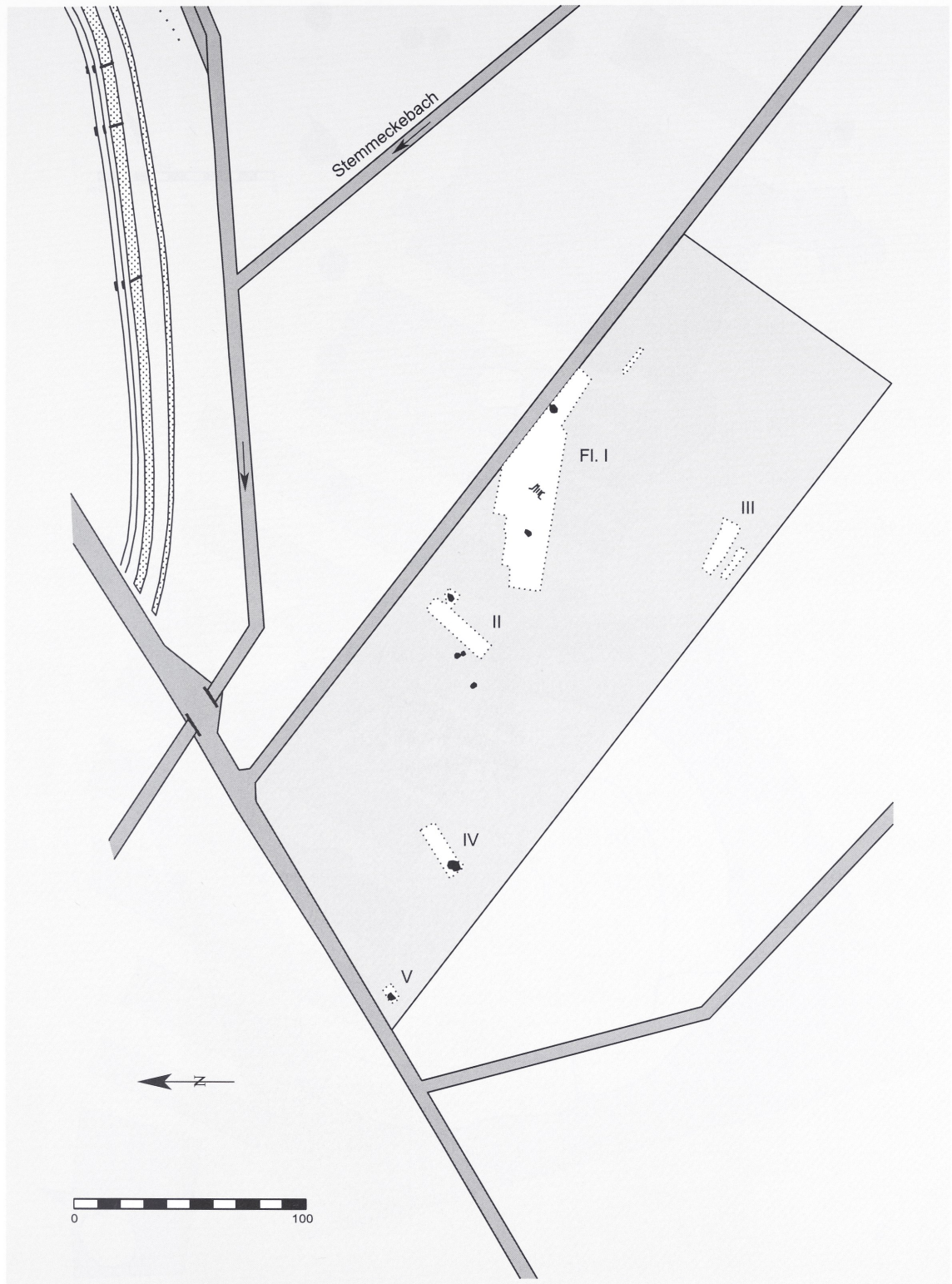

*Delbrück-Anreppen (Dkz. 4217,75), Gesamtplan der Ausgrabungen 1971;
im Norden ein Teil der südlichen Umwehrung des Römerlagers.*

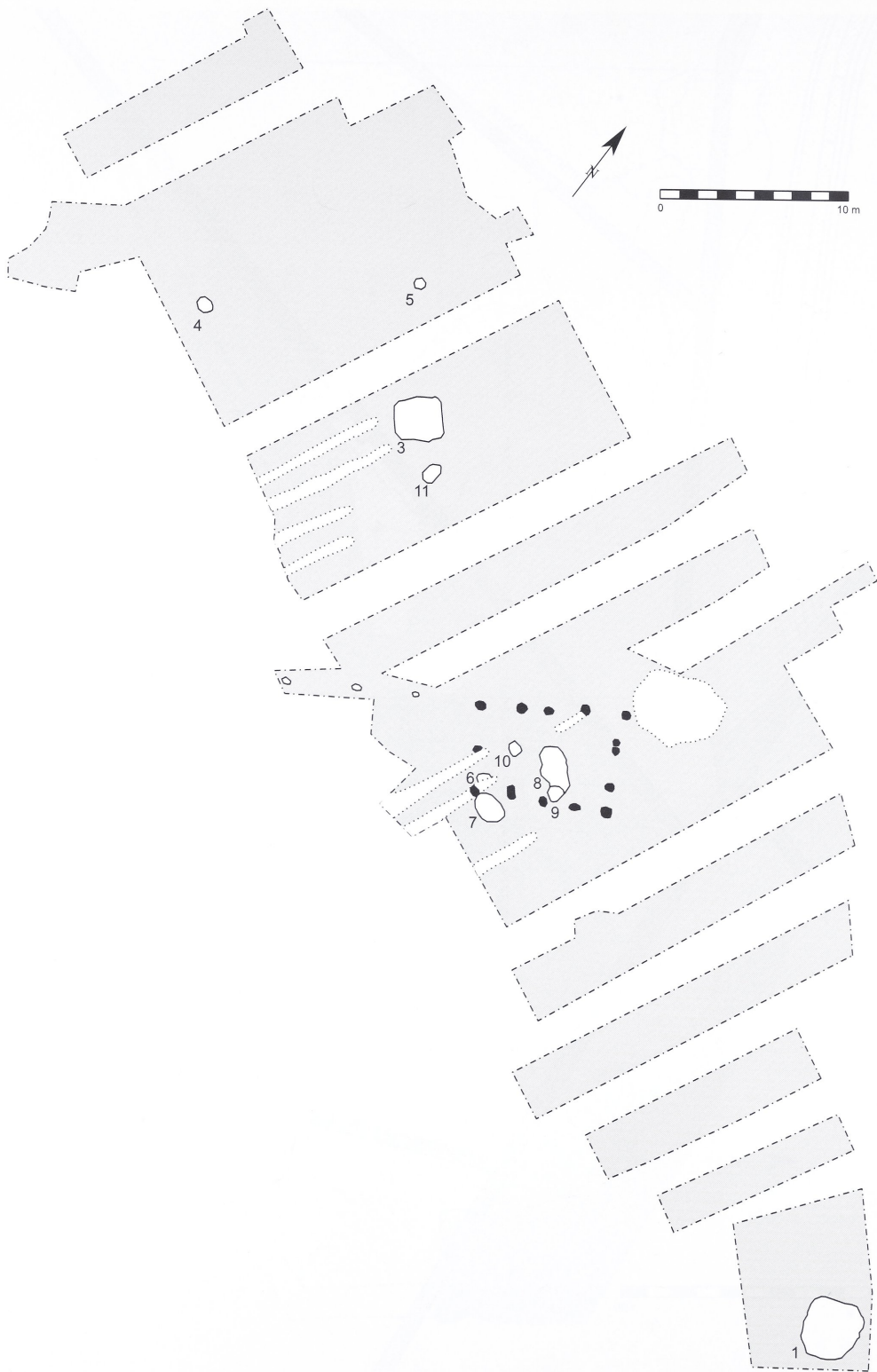

Delbrück-Anreppen (Dkz. 4217,75), Befundplan der Fläche I.

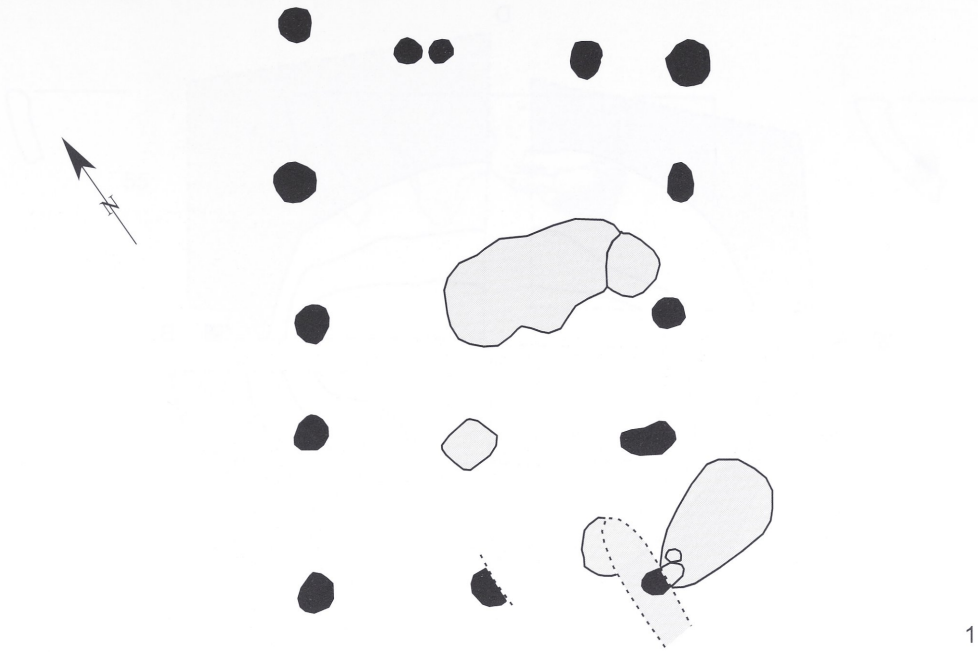

1

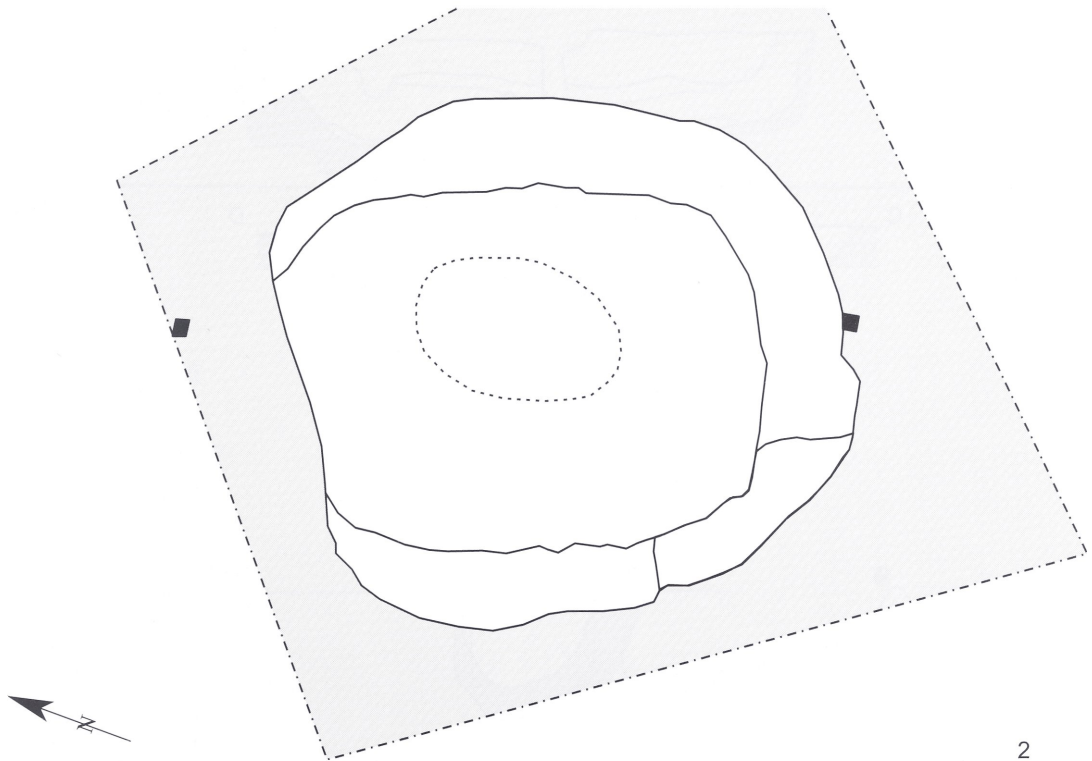

2

*Delbrück-Anreppen (Dkz. 4217,75), 1. Pfostengrundriß; 2. Bef. 1, "Brunnen",
Aufsicht 0,15 m unter Hauptplanum. - 1 M. 1:100; 2 M. 1:20.*

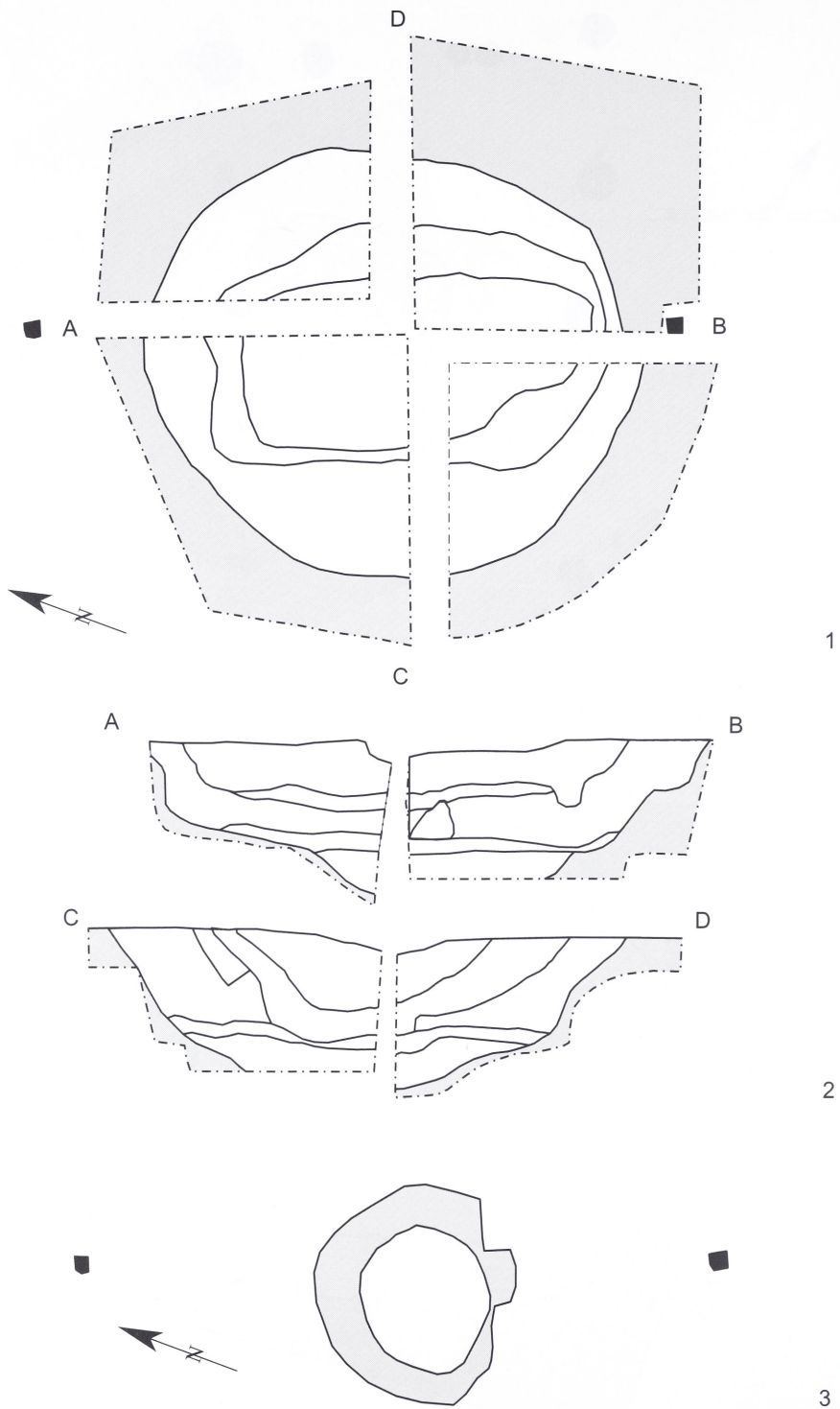

Delbrück-Anreppen (Dkz. 4217,75). 1. Bef. 1, "Brunnen", Aufsicht 0,42 m unter Hauptplanum; 2. Bef. 1, "Brunnen", Profilansichten; 3. Bef. 1, "Brunnen"; Ansicht 1,15 m unter Hauptplanum. - M. 1:20.



55



6

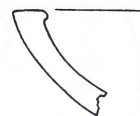

26



3

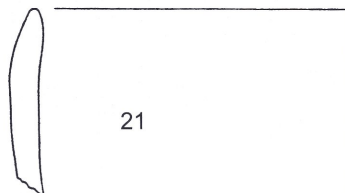

21



31

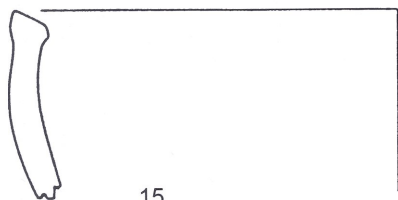

15

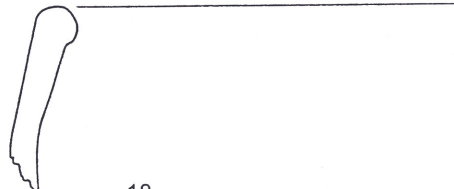

18

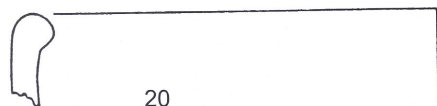

20



16



30

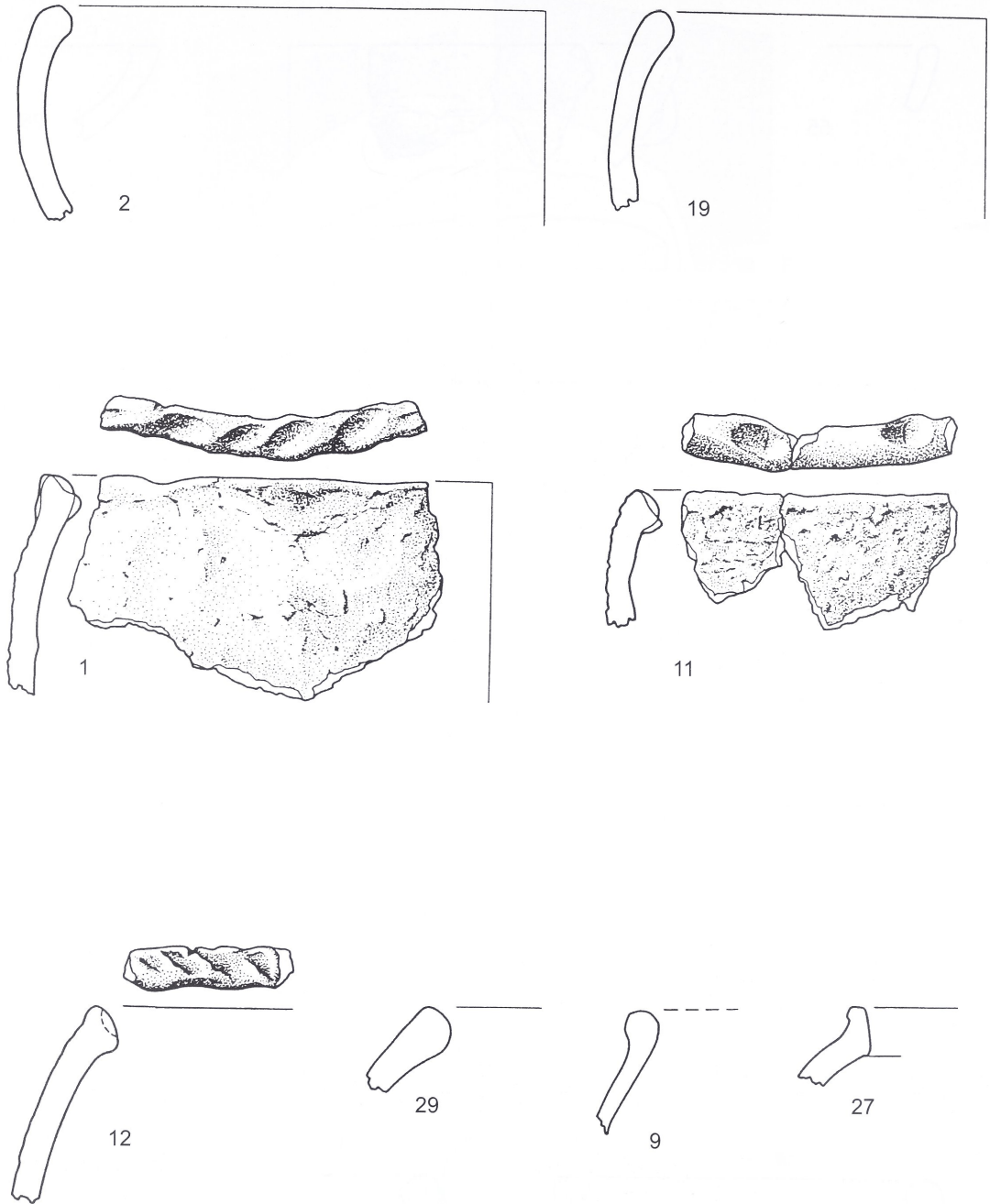

Delbrück-Anreppen (Dkz. 4217,75). Gr. a. - Keramik M. 1:2.

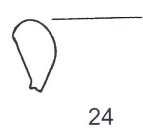
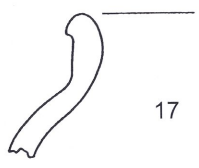
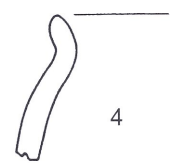
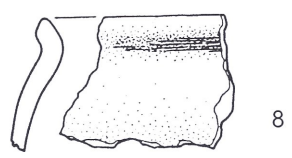
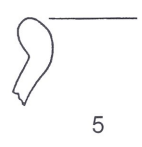
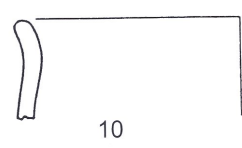
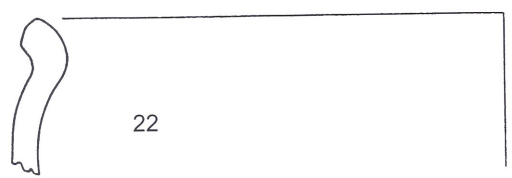
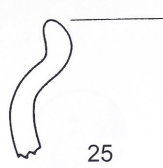
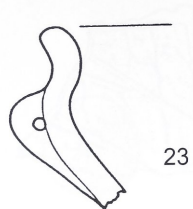

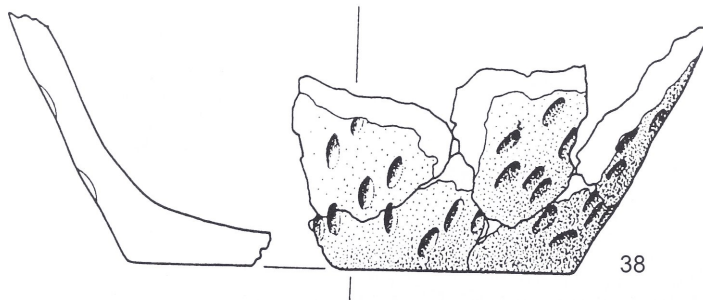
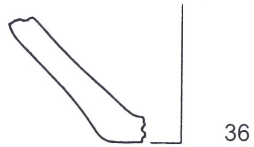
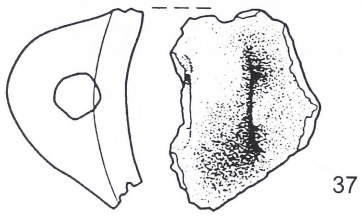

Delbrück-Anreppen (Dkz. 4217,75). Gr. a. - Keramik M. 1:2.

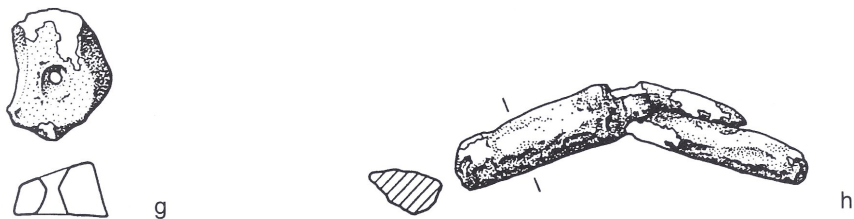
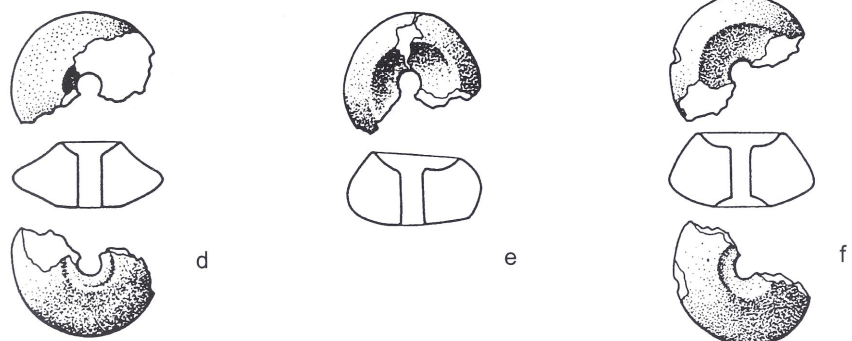
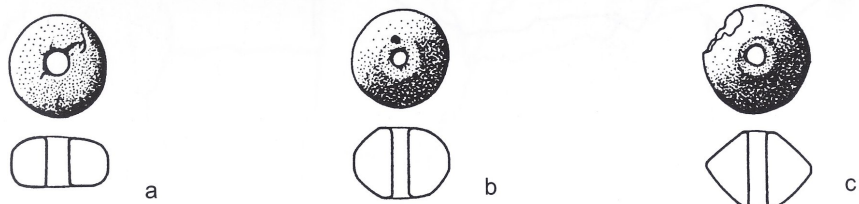

Delbrück-Anreppen (Dkz. 4217,75). Gr. a. - Blei, Keramik M. 1:2.

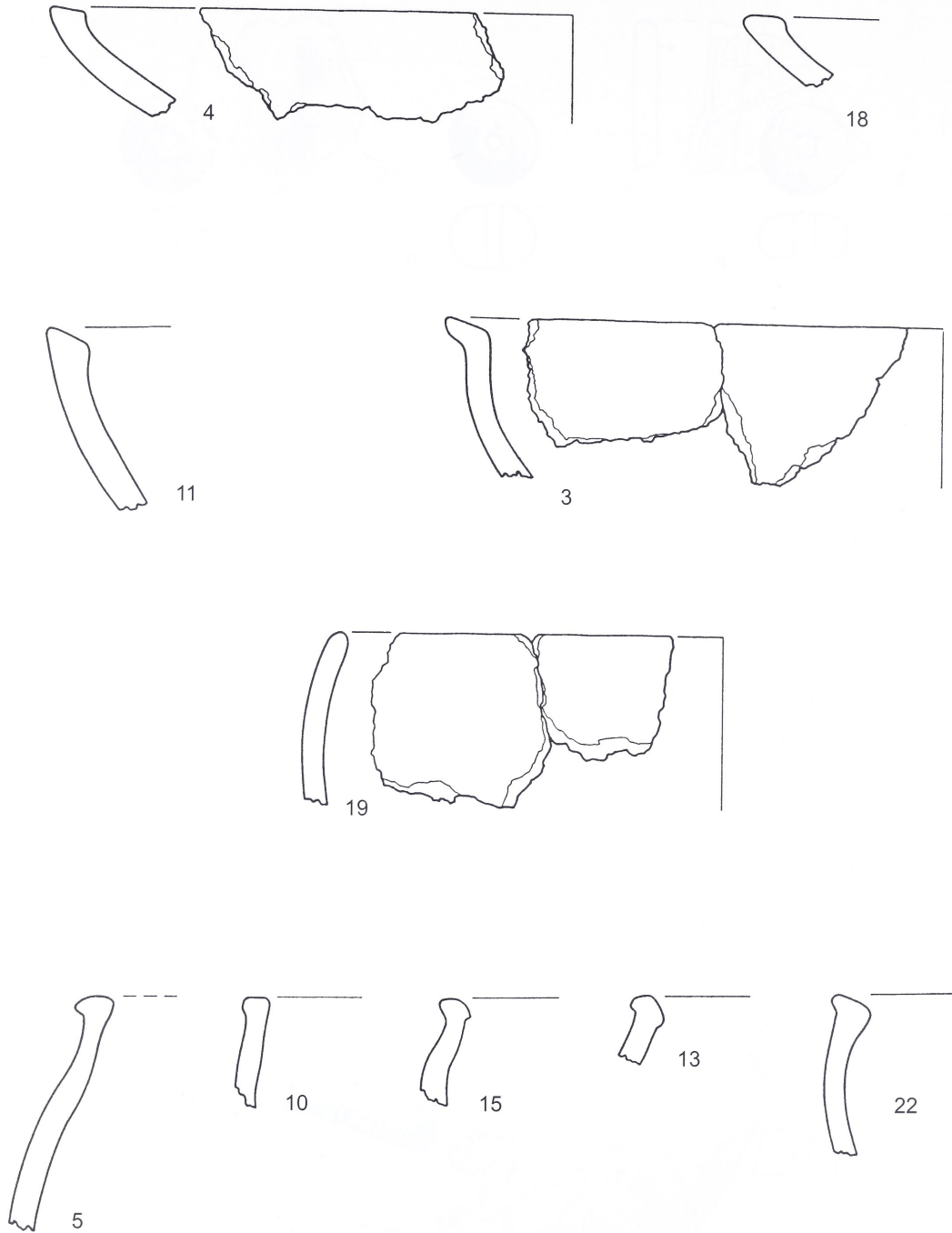

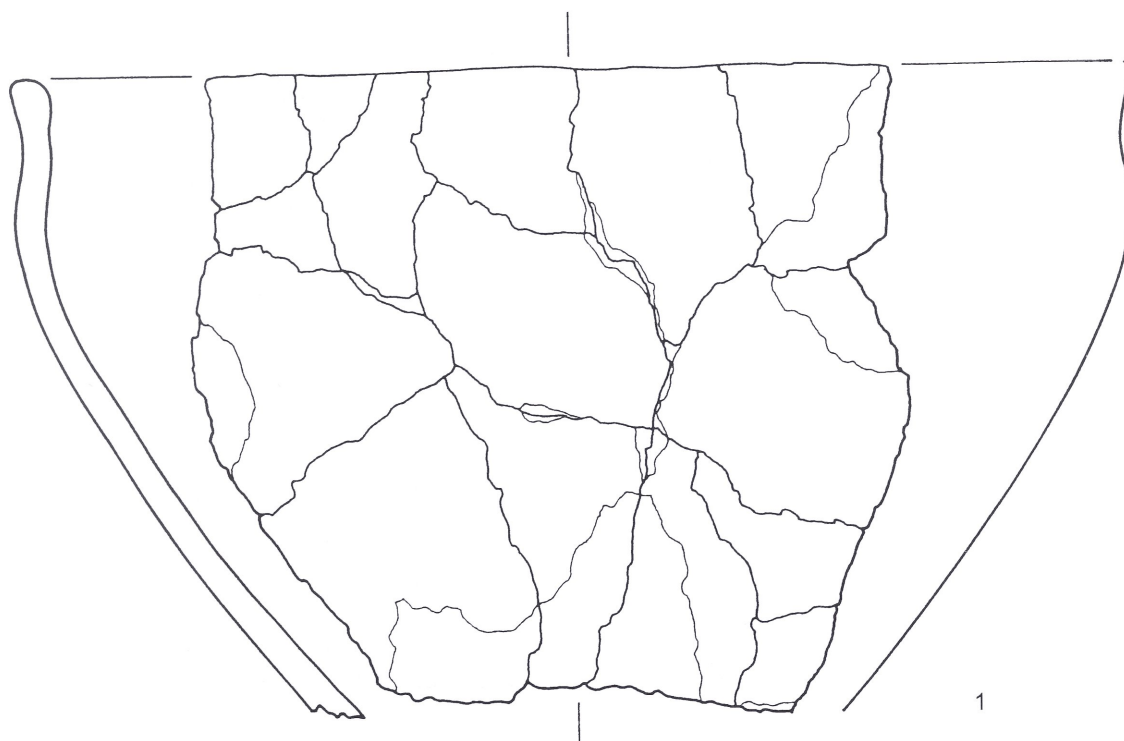
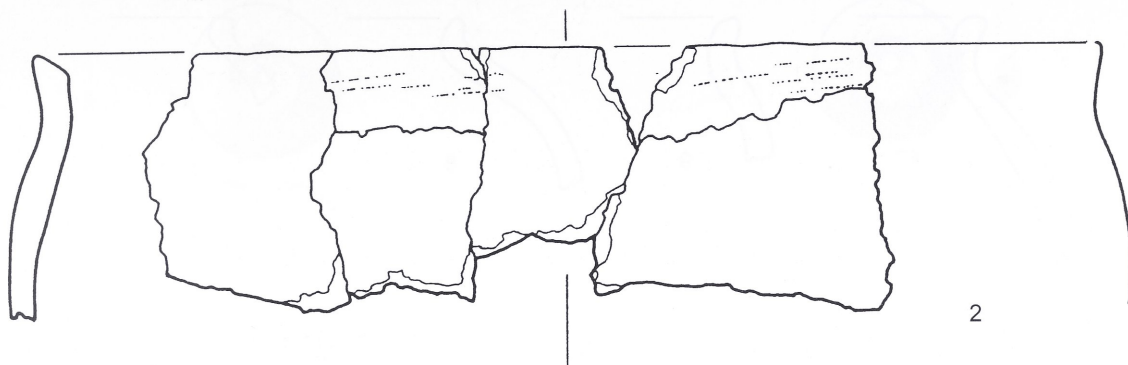

Delbrück-Anreppen (Dkz. 4217,75). Gr. c. - Keramik M. 1:2.

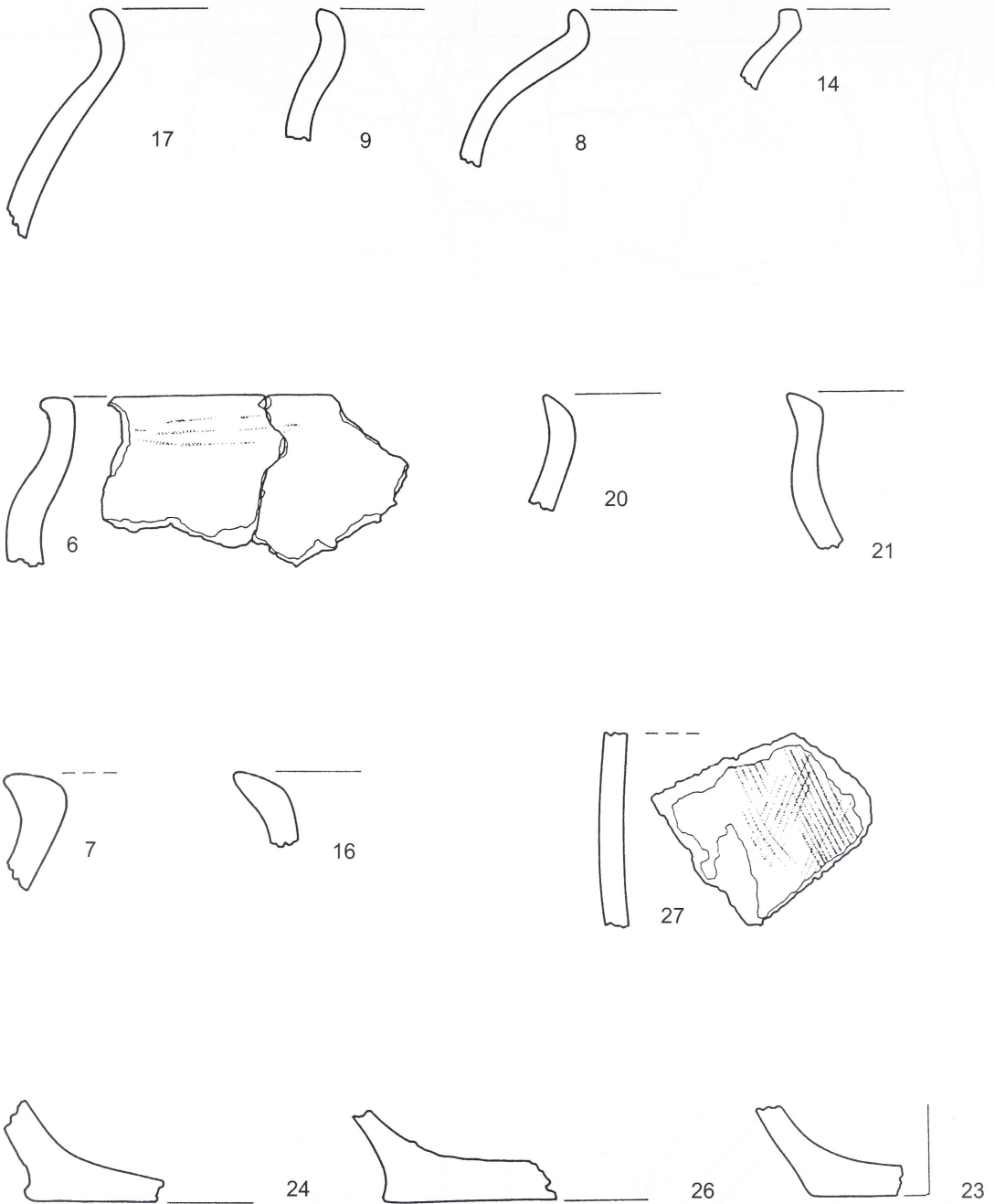

Delbrück-Anreppen (Dkz. 4217,75). Gr. c. - Keramik M. 1:2.

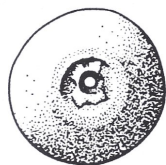

c

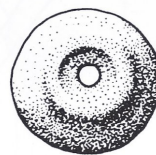

a

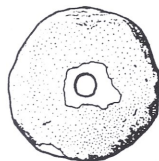

d



b

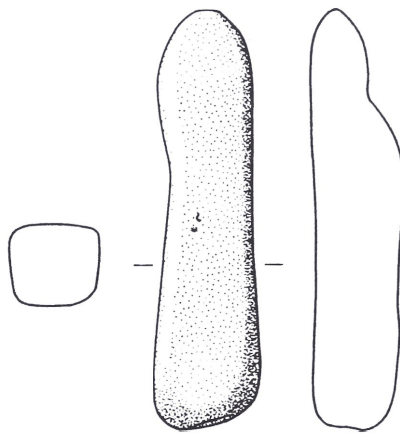
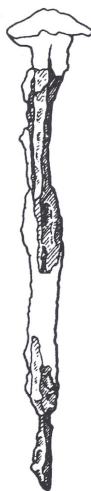

Delbrück-Anreppen (Dkz. 4217,75). Gr. c. - Eisen, Stein, Keramik M. 1:2.

TAFEL 48

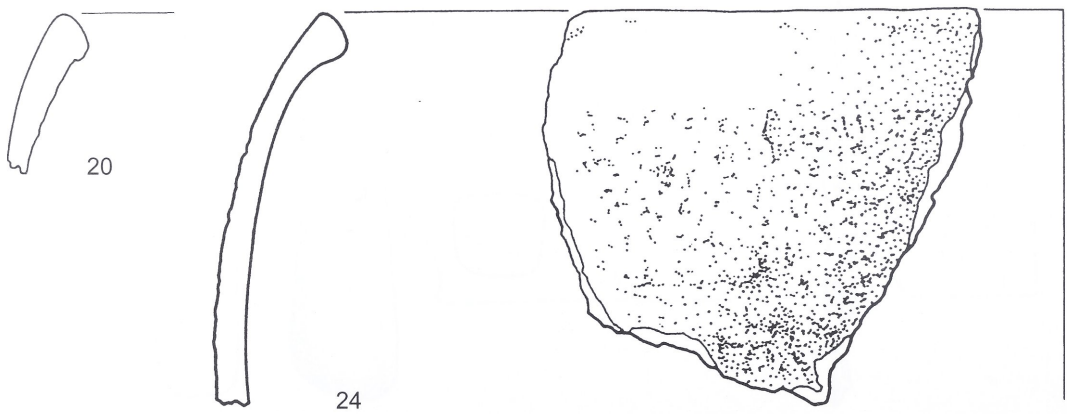
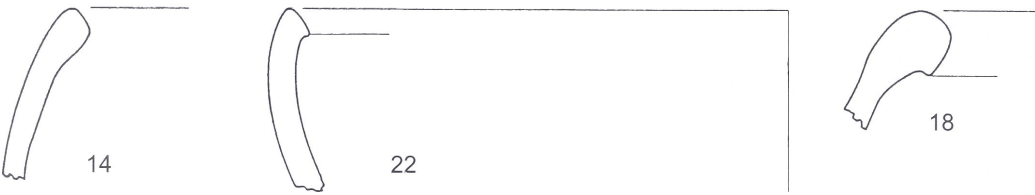
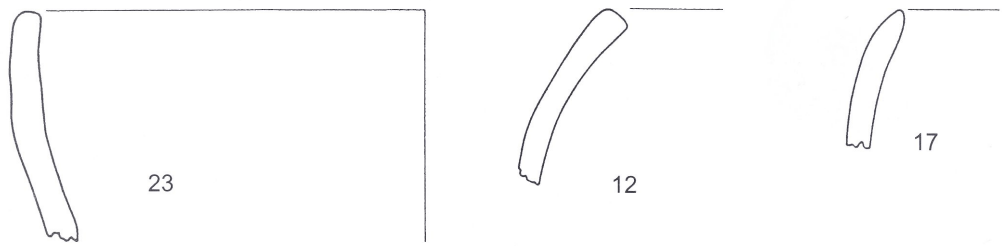
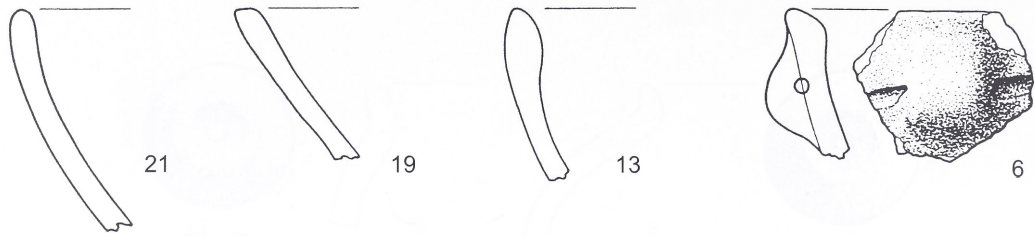

Delbrück-Anreppen (Dkz. 4217,75). Gr. d. - Keramik M. 1:2.

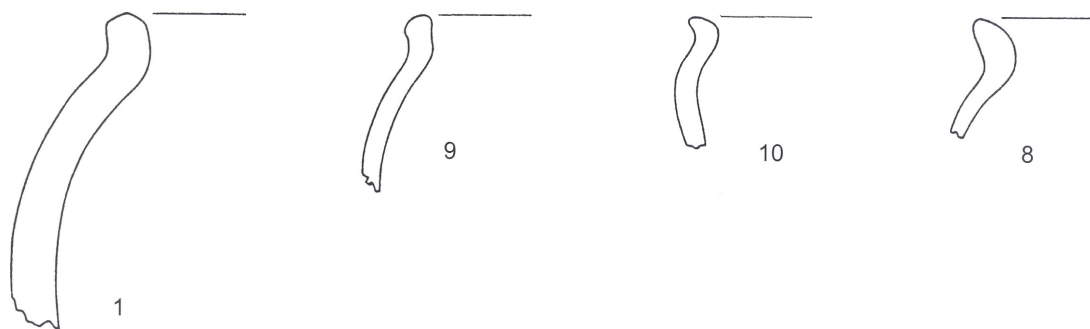
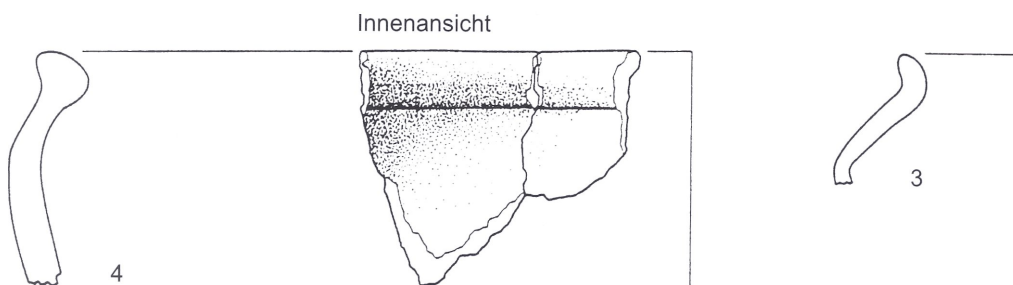
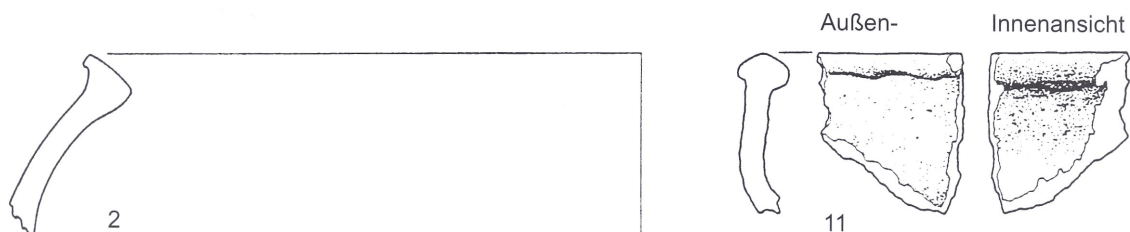
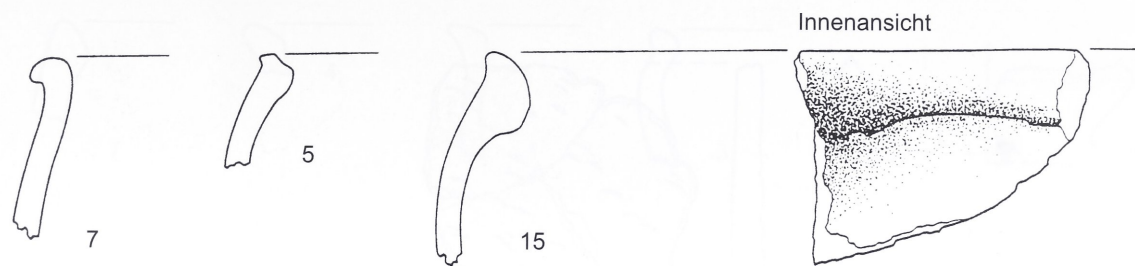

Delbrück-Anreppen (Dkz. 4217,75). Gr. d. - Keramik M. 1:2.

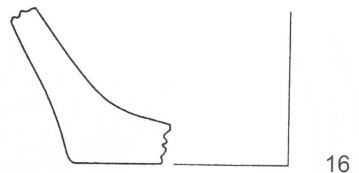
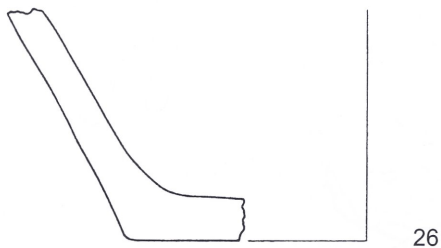
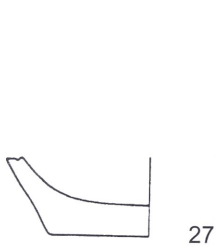
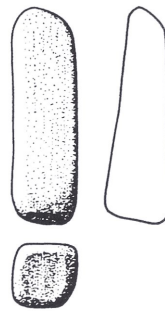
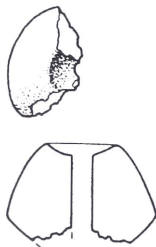
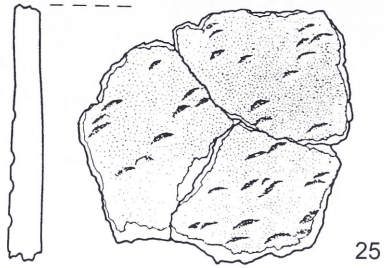

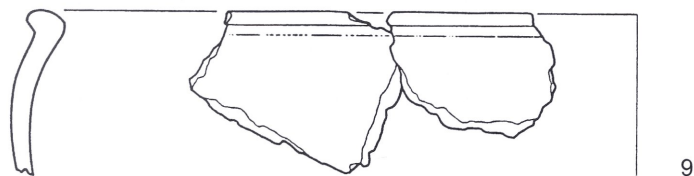
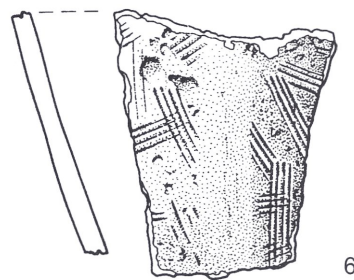
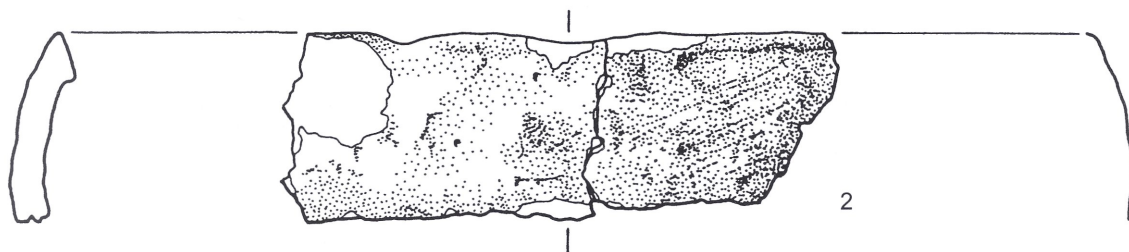
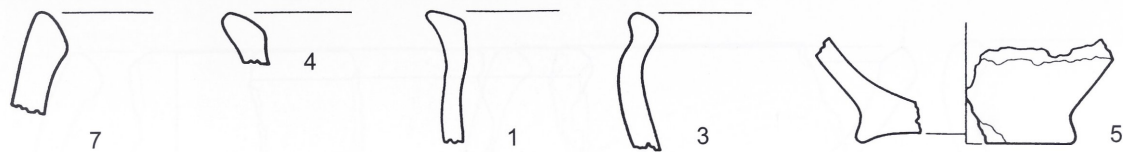

Delbrück-Anreppen (Dkz. 4217,75). Oben Gr. e; unten Gr. 6. - Keramik M. 1:2.

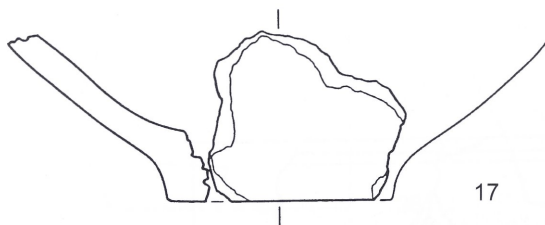
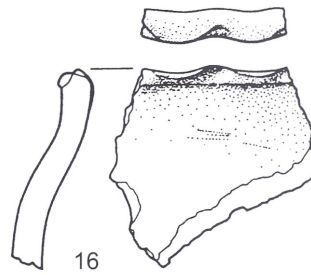
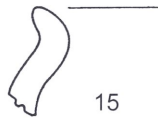
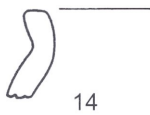
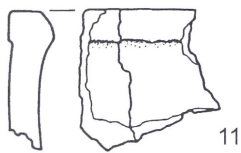
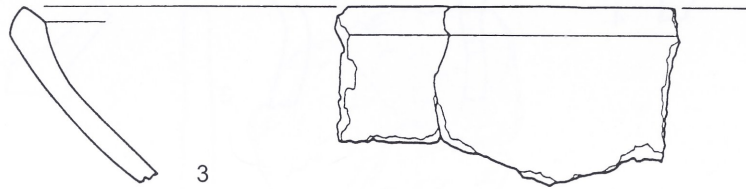

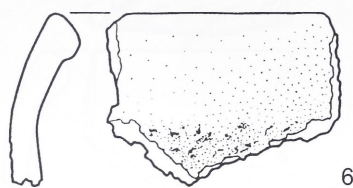

6

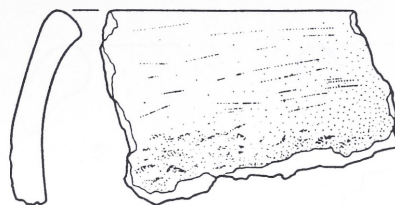

4



5



7

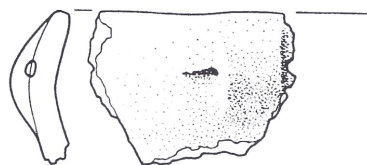

8



9

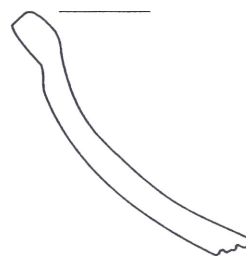

13

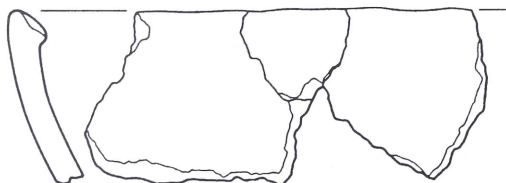

10



1



2

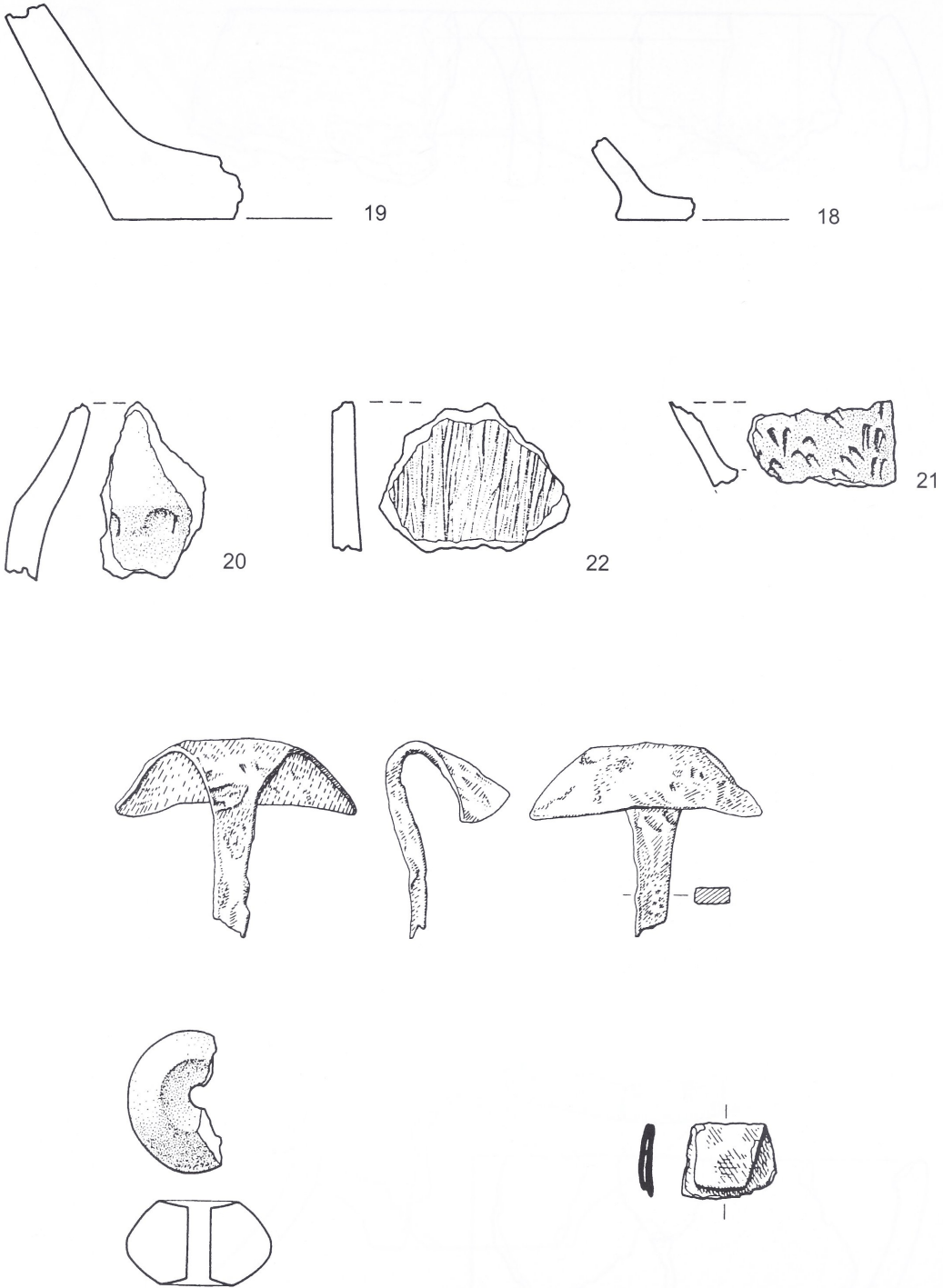

Delbrück-Anreppen (Dkz. 4217,75). Gr. f. - Eisen, Blei, Keramik M. 1:2.

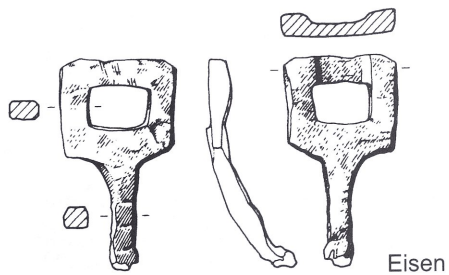
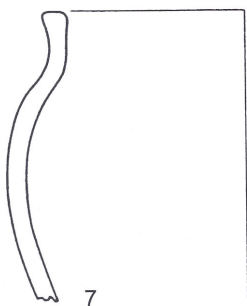
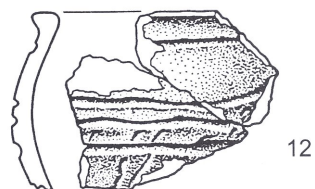
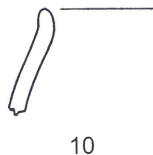
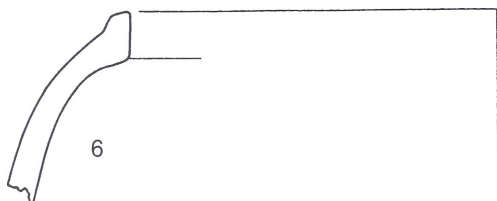
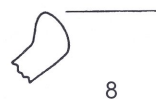
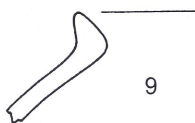
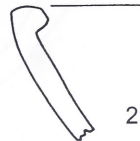
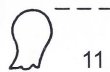
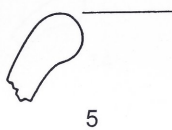
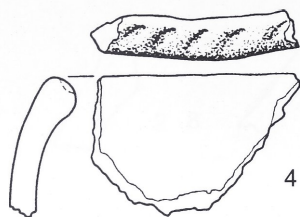

Delbrück-Anreppen (Dkz. 4217,75). Gr. 1. - Eisen, Keramik M. 1:2.

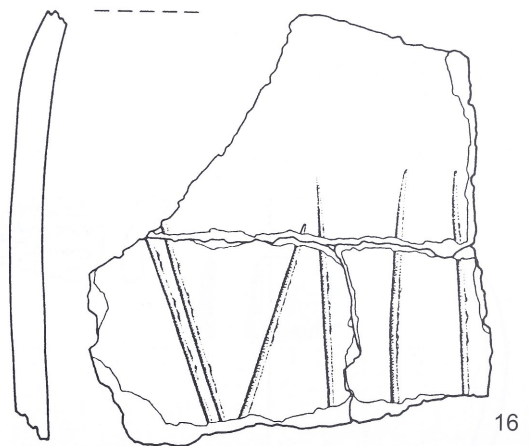
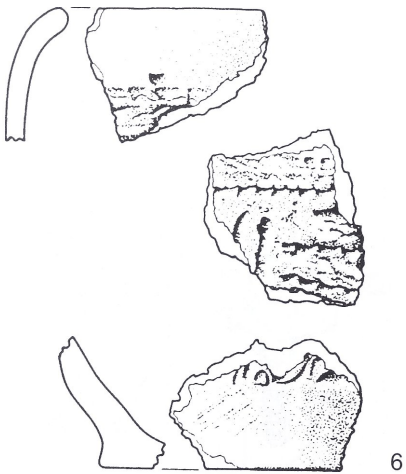
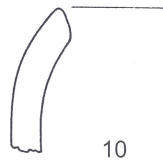
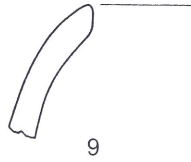
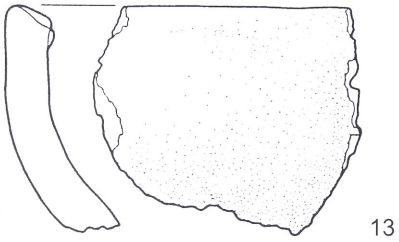
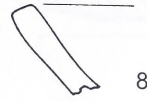
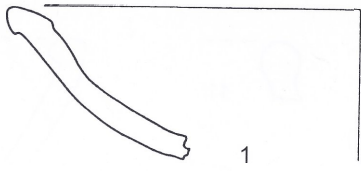

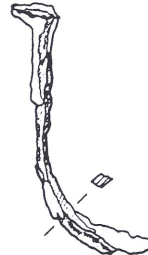
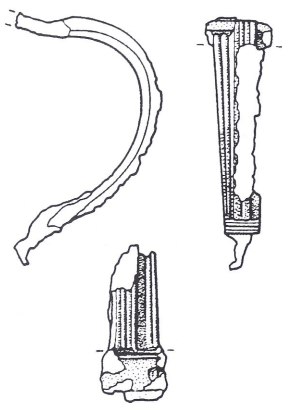
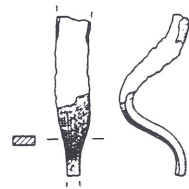
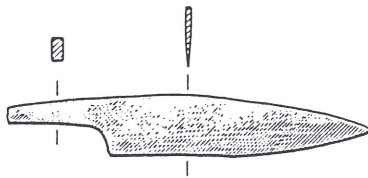
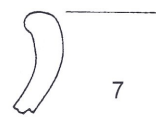
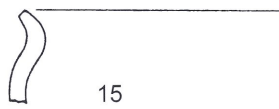
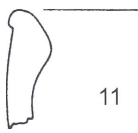
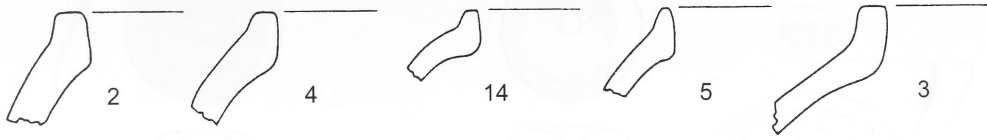

Delbrück-Anreppen (Dkz. 4217,75). Gr. 3. - Eisen, Keramik M. 1:2; Bronze M. 1:1.

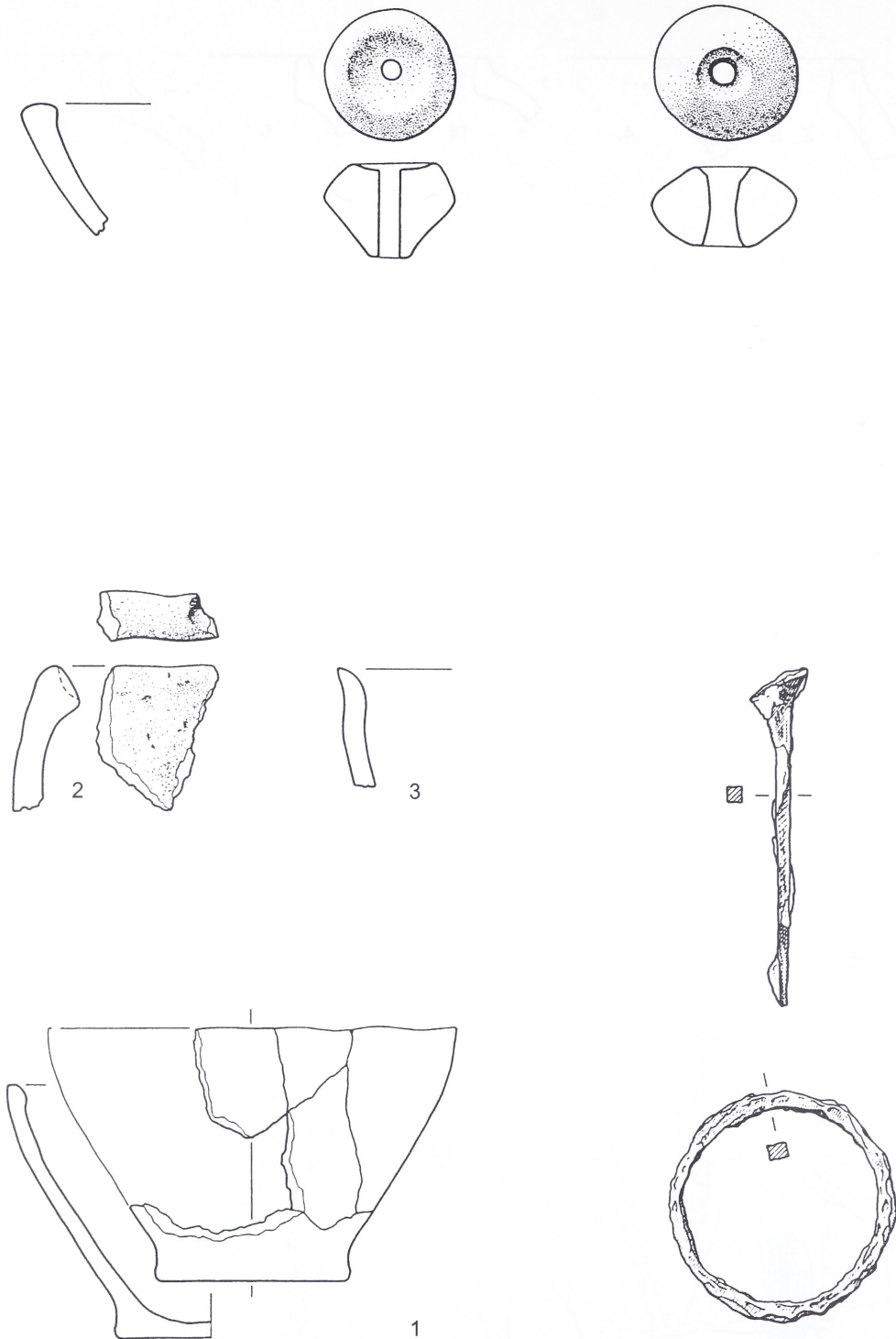

Delbrück-Anreppen (Dkz. 4217,75). Reihe 1 Gr. 7; übrige Gr. 9. - Eisen, Keramik M. 1:2.

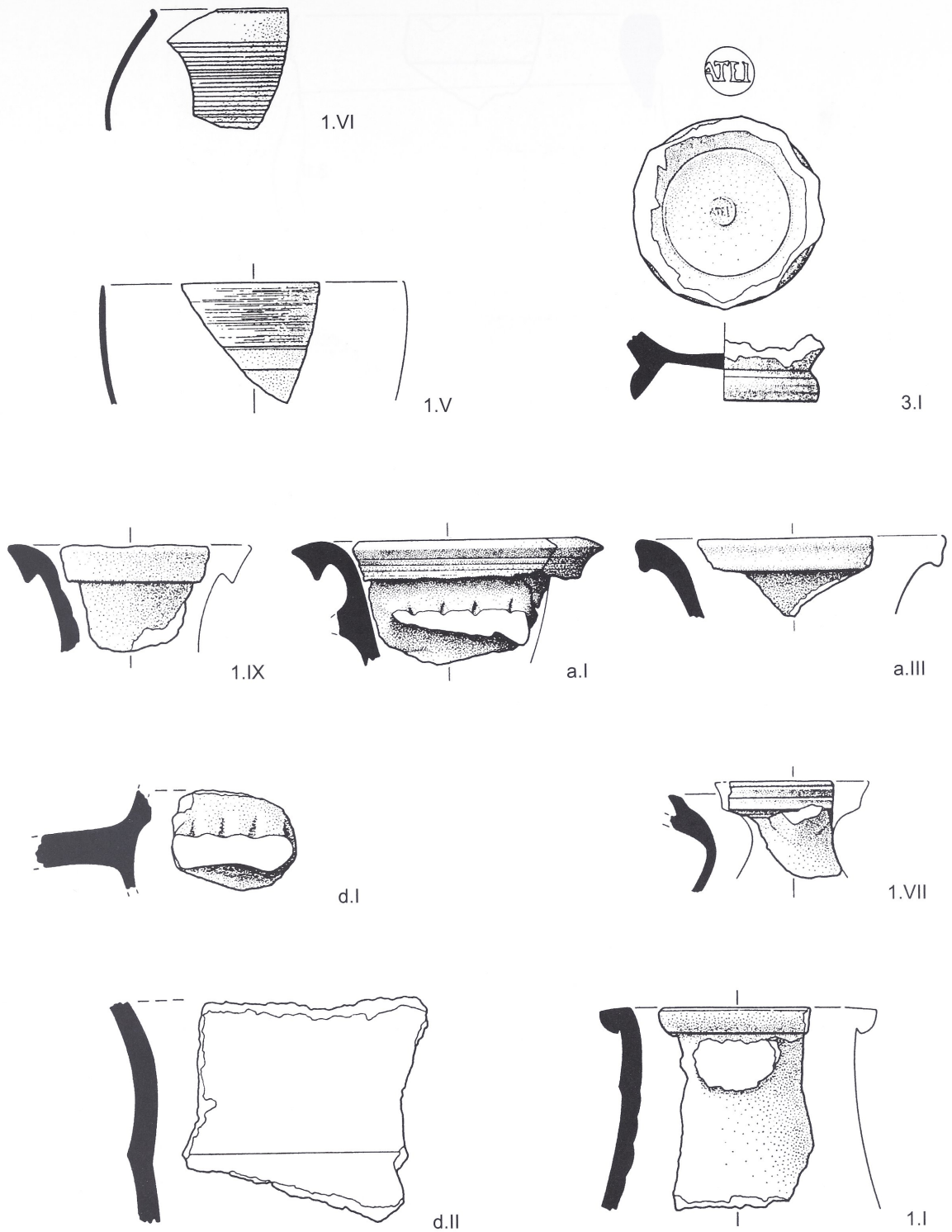

Delbrück-Anreppen (Dkz. 4217,75). Römische Keramik aus germanischen Befunden. - M. 1:2.

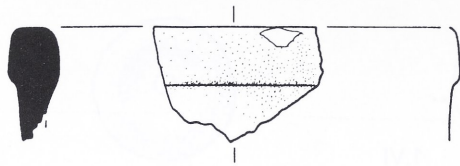

3.II

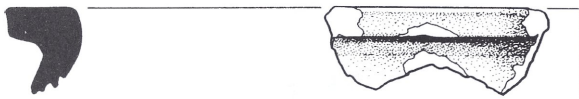

a.II

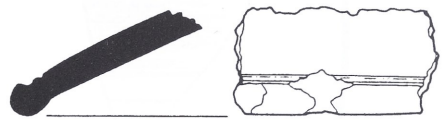

d.III

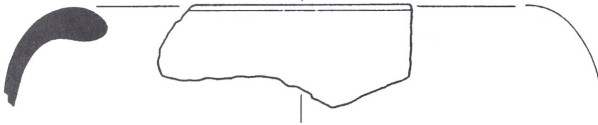

1.VIII



1.II

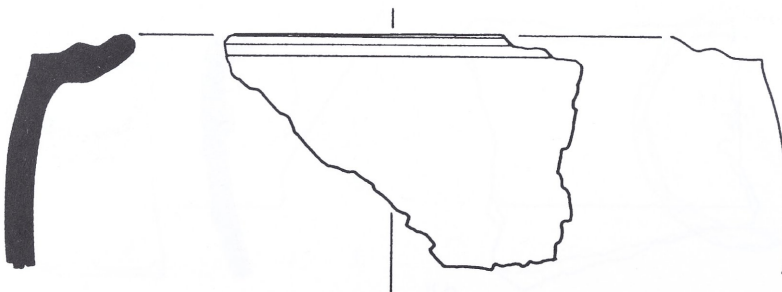
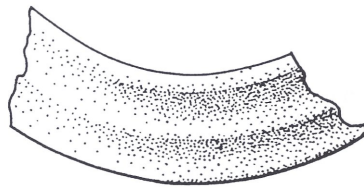

1.III

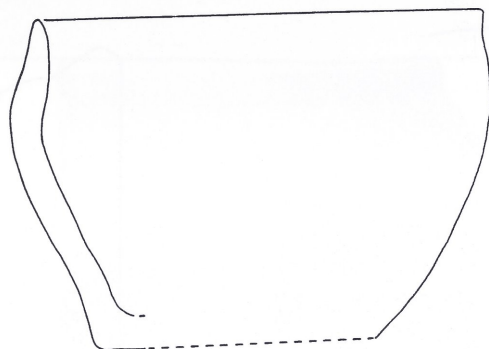

h

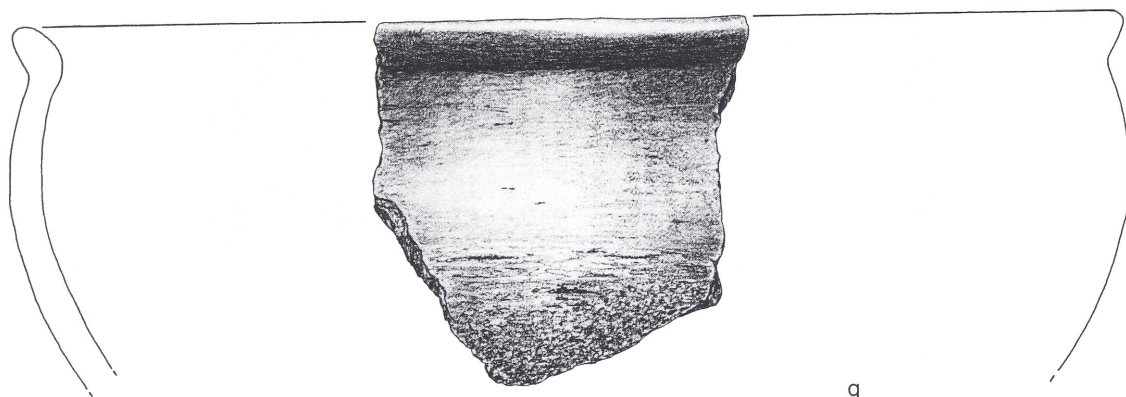

g

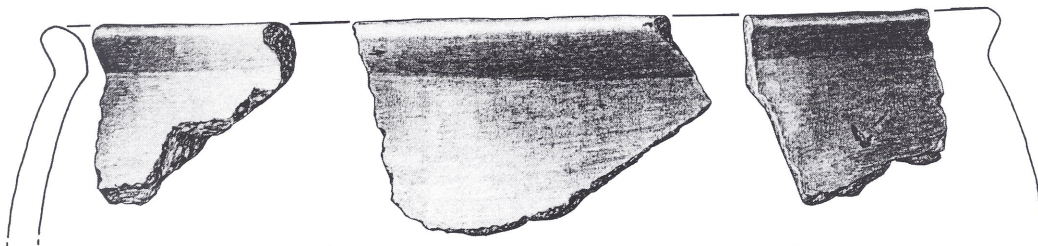

i

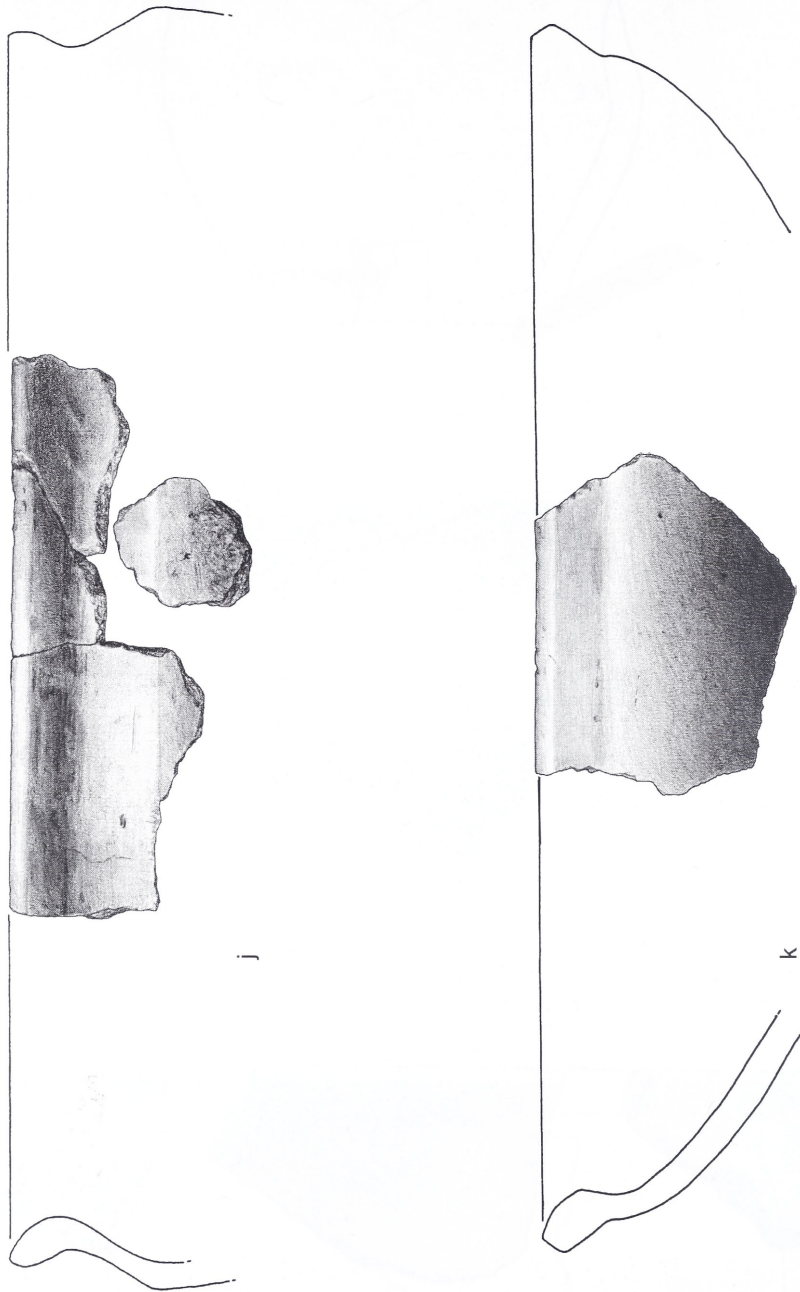

Haltern. Germanische Keramik aus römischen Befunden. - M. 1:2.

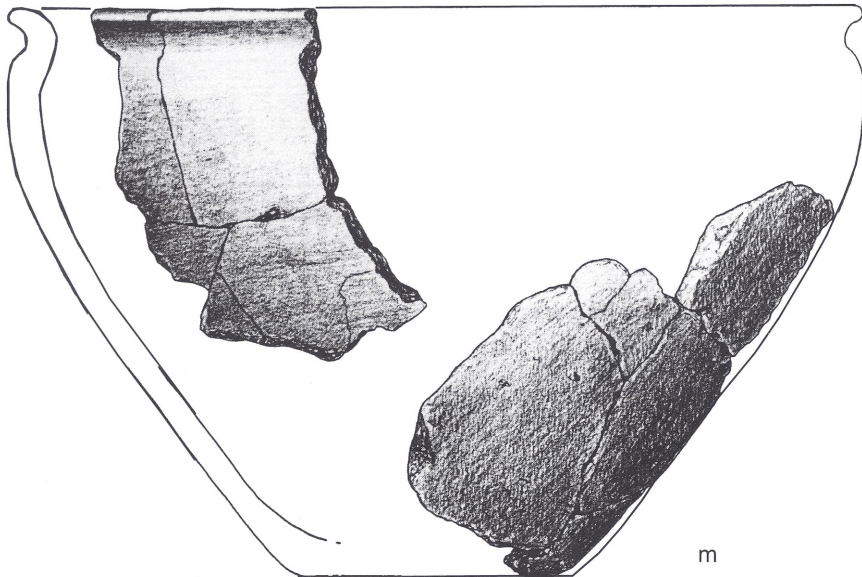
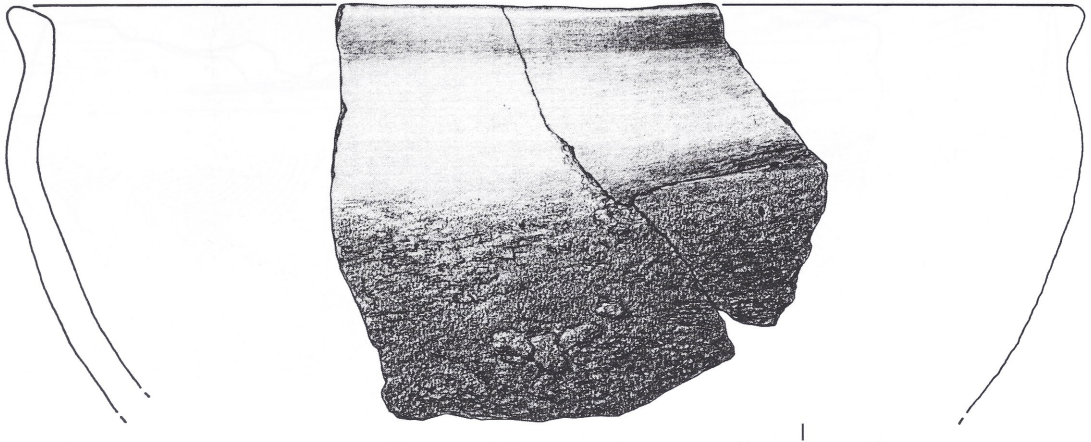

Haltern. Germanische Keramik aus römischen Befunden. - M. 1:2.

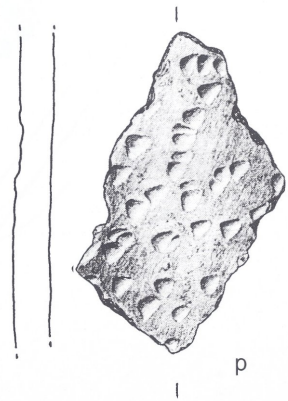
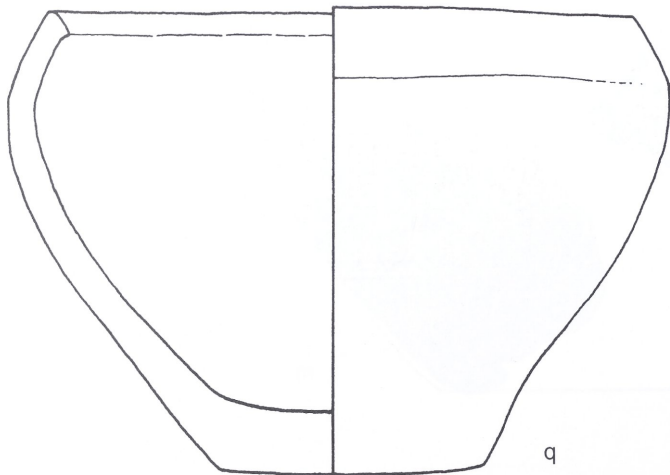
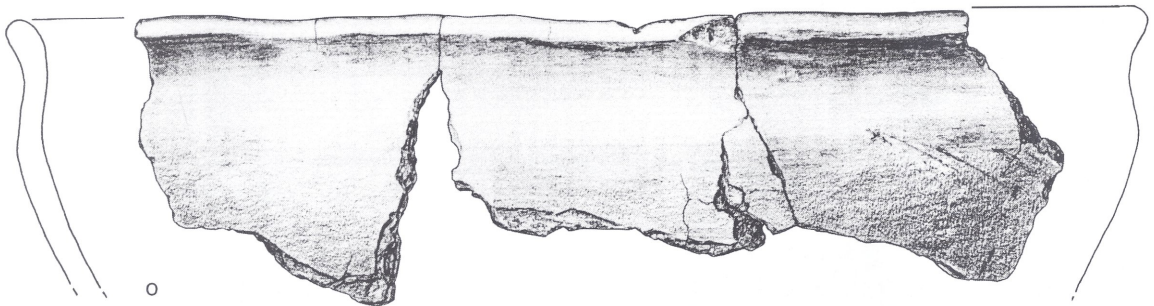
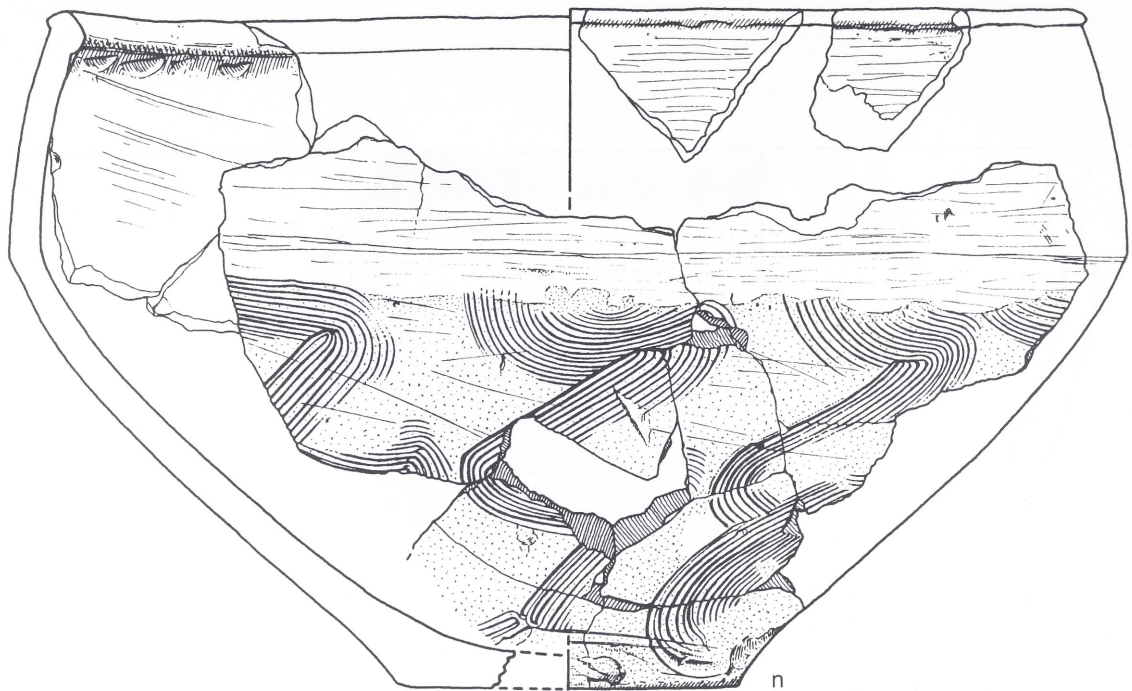

Haltern. Germanische Keramik aus römischen Befunden. - M. 1:2.

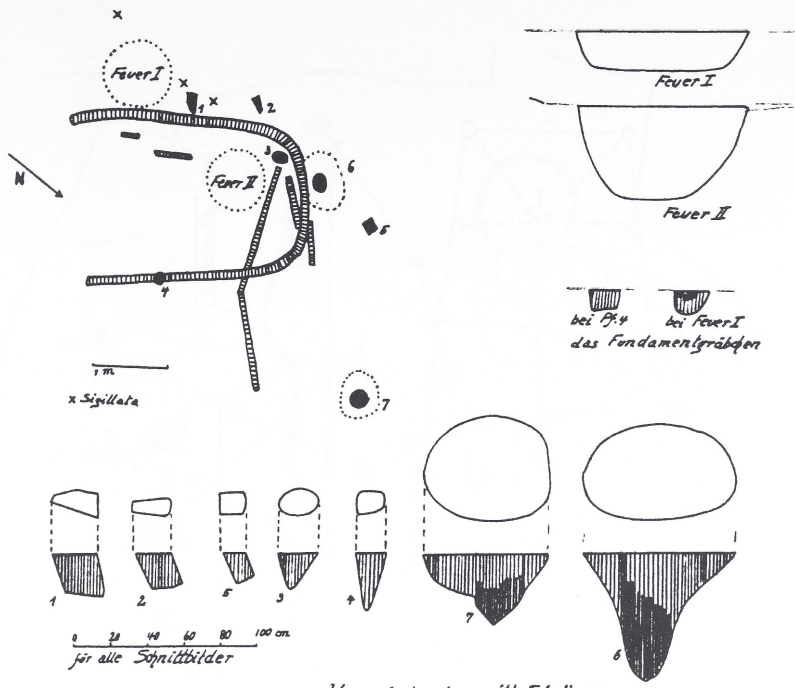

Haus 1 der eisenz. Siedlung

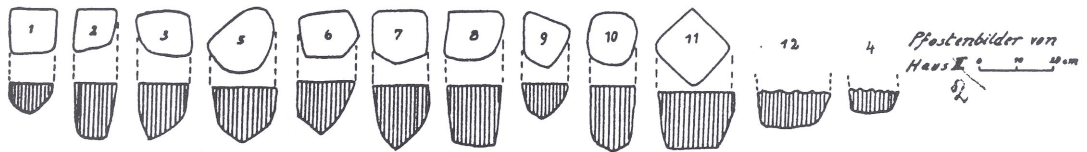
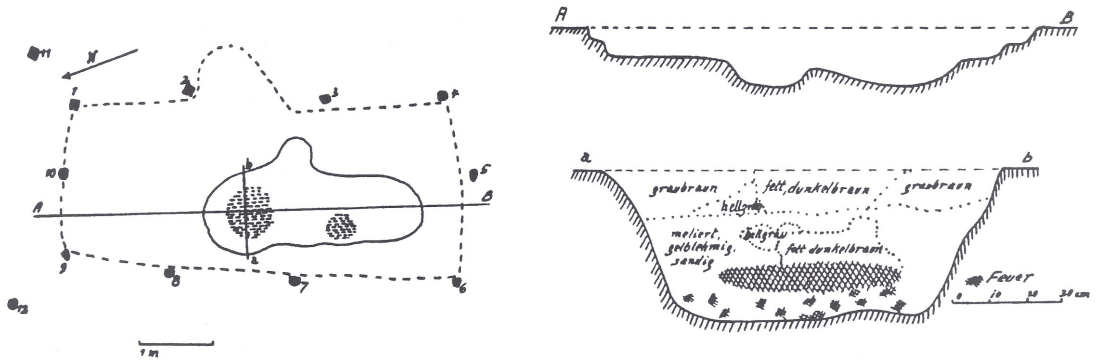

Pfeilerbilder von Haus II

Haus 2

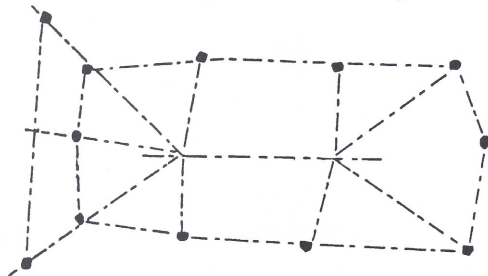

Rüthen-Kneblinghausen. 1. Geb. 1, Grundriß und Profile; 2. Geb. 2, Grundriß und Profile.

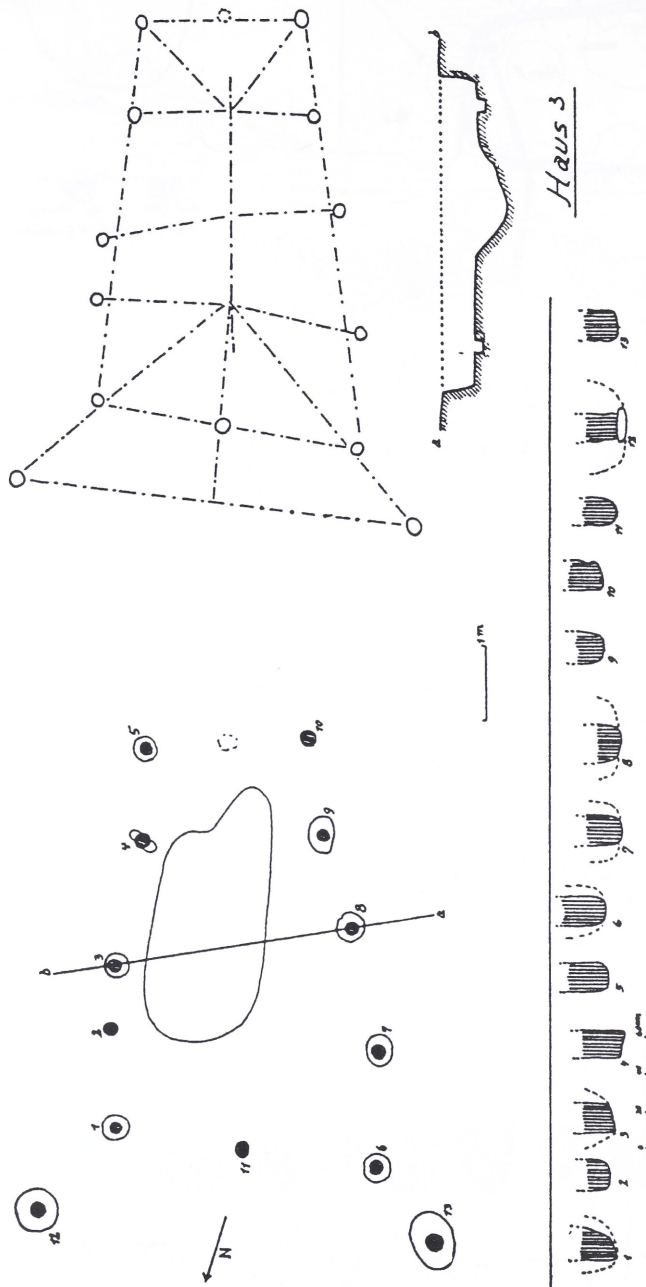

Rüthen-Kneblinghausen. Geb. 3, Grundriß und Profile.

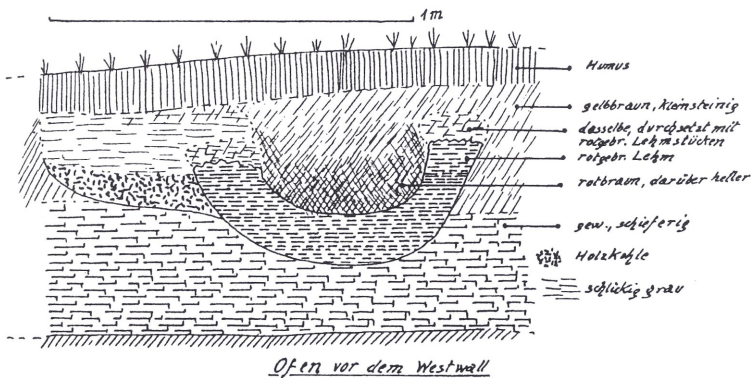
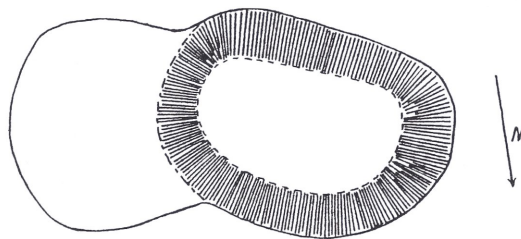
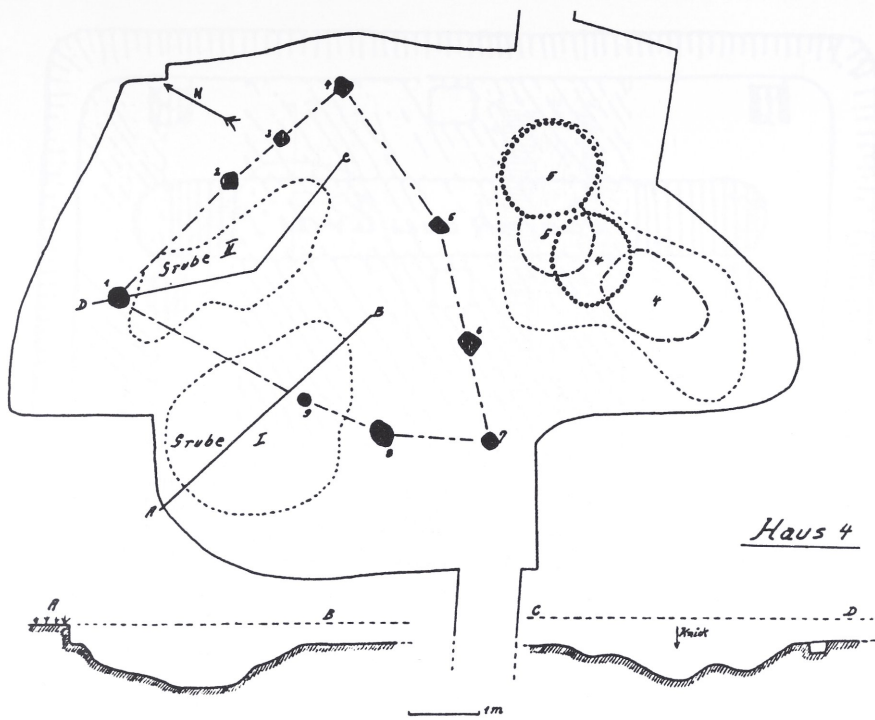

Rüthen-Kneblinghausen. 1. Geb. 4, Pfosten und Profile; 2. Ofen 6, Aufsicht und Profile.

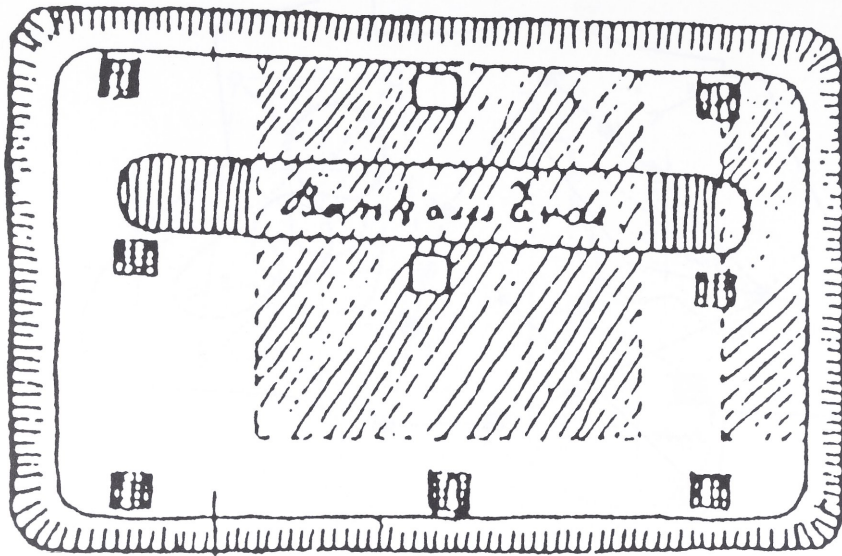

 Nicht ausgegraben

1

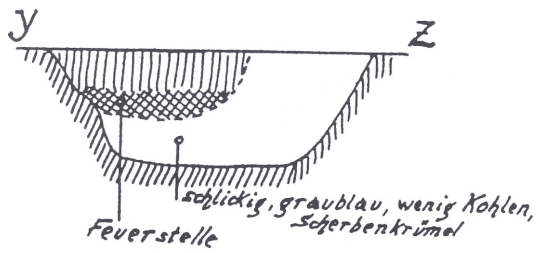

2

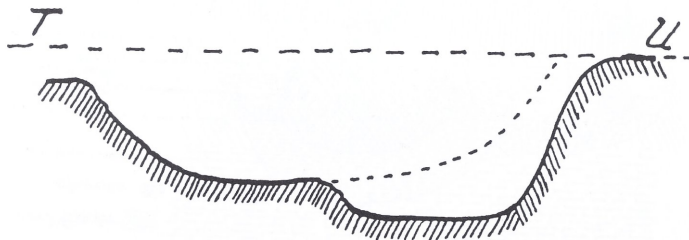

3

Rüthen-Kneblinghausen. 1. Geb. 9, Grundriß; 2. Gr. 31, Profil; 3. Gr. 33, Profil.

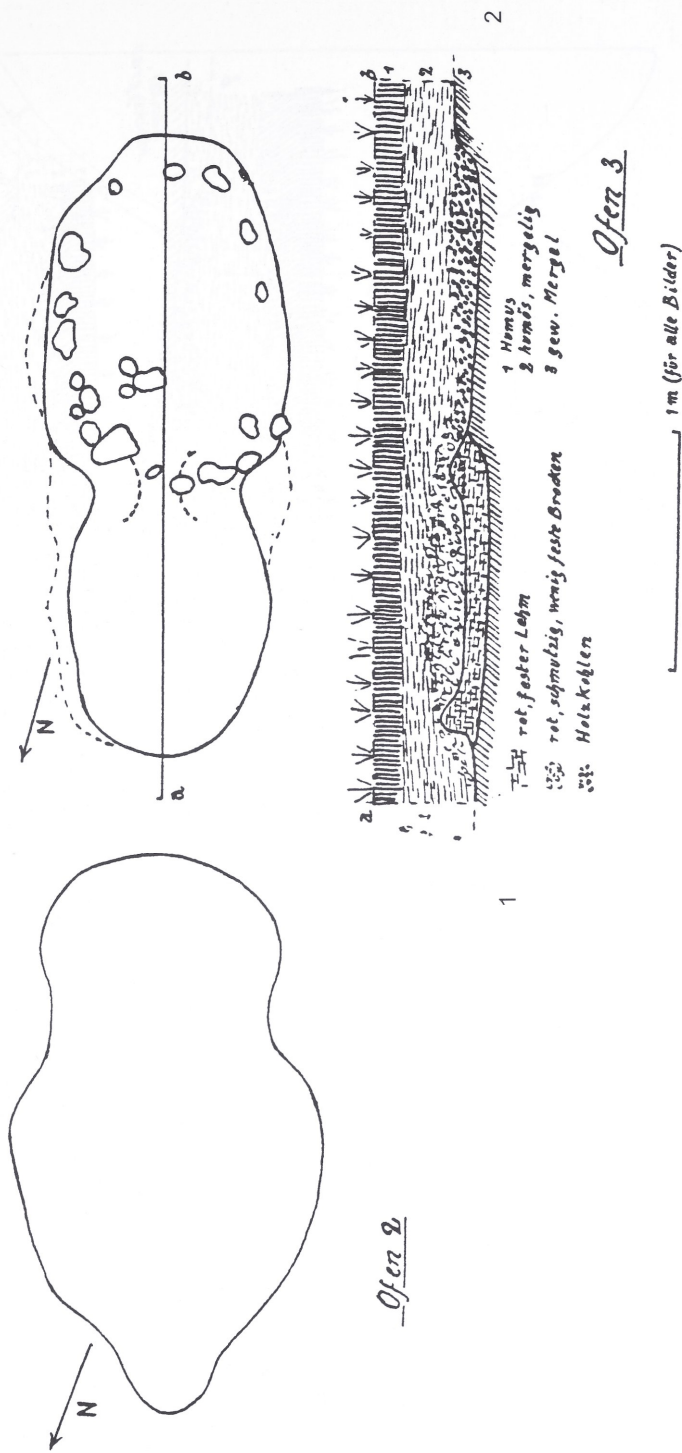

Rüthen-Kneblinghausen. 1. Ofen 2, Aufsicht; 2. Ofen 3, Aufsicht und Profil.

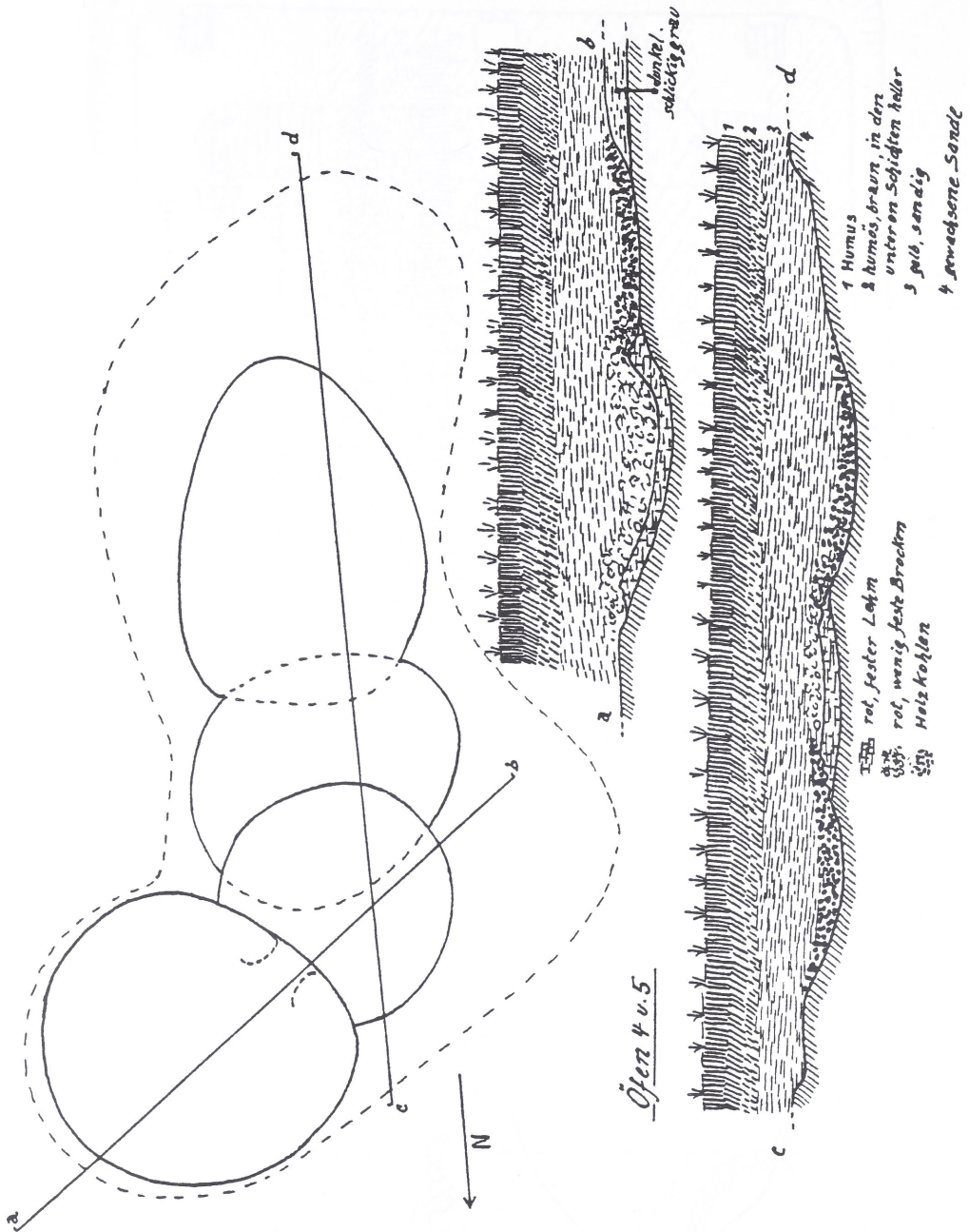

Rüthen-Kneblinghausen. Öfen 4 und 5, Aufsicht und Profile.

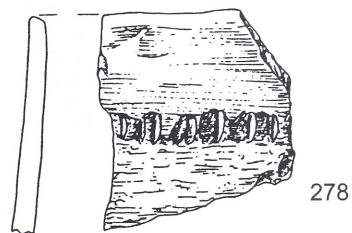
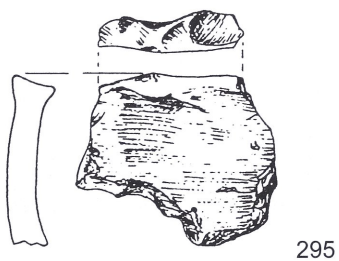
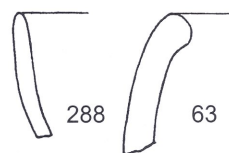
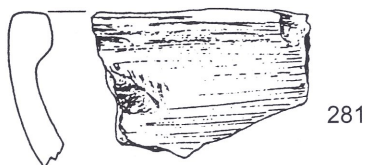
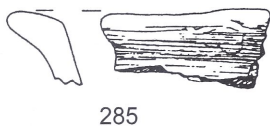
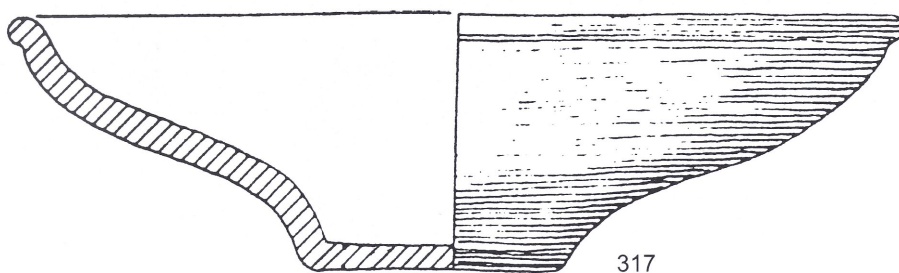
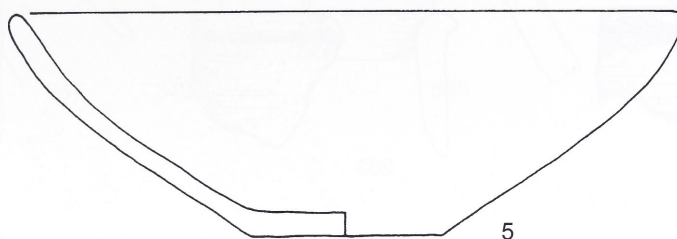

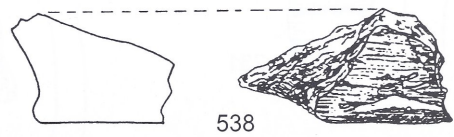
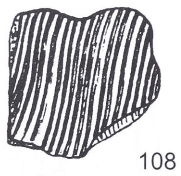
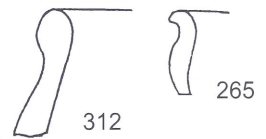
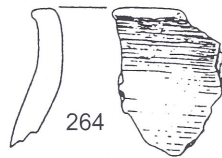
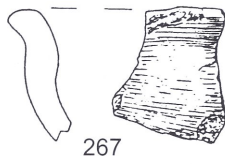
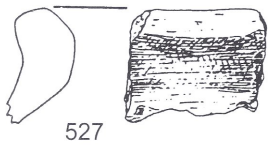
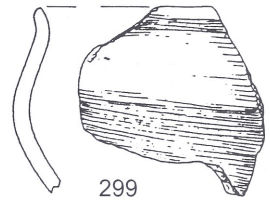
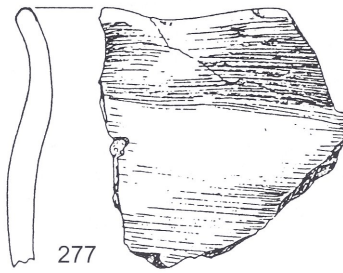
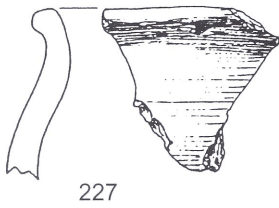
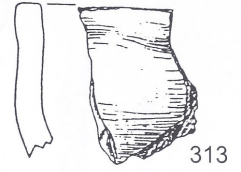
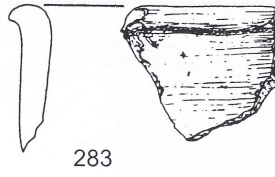
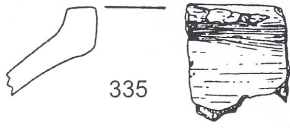

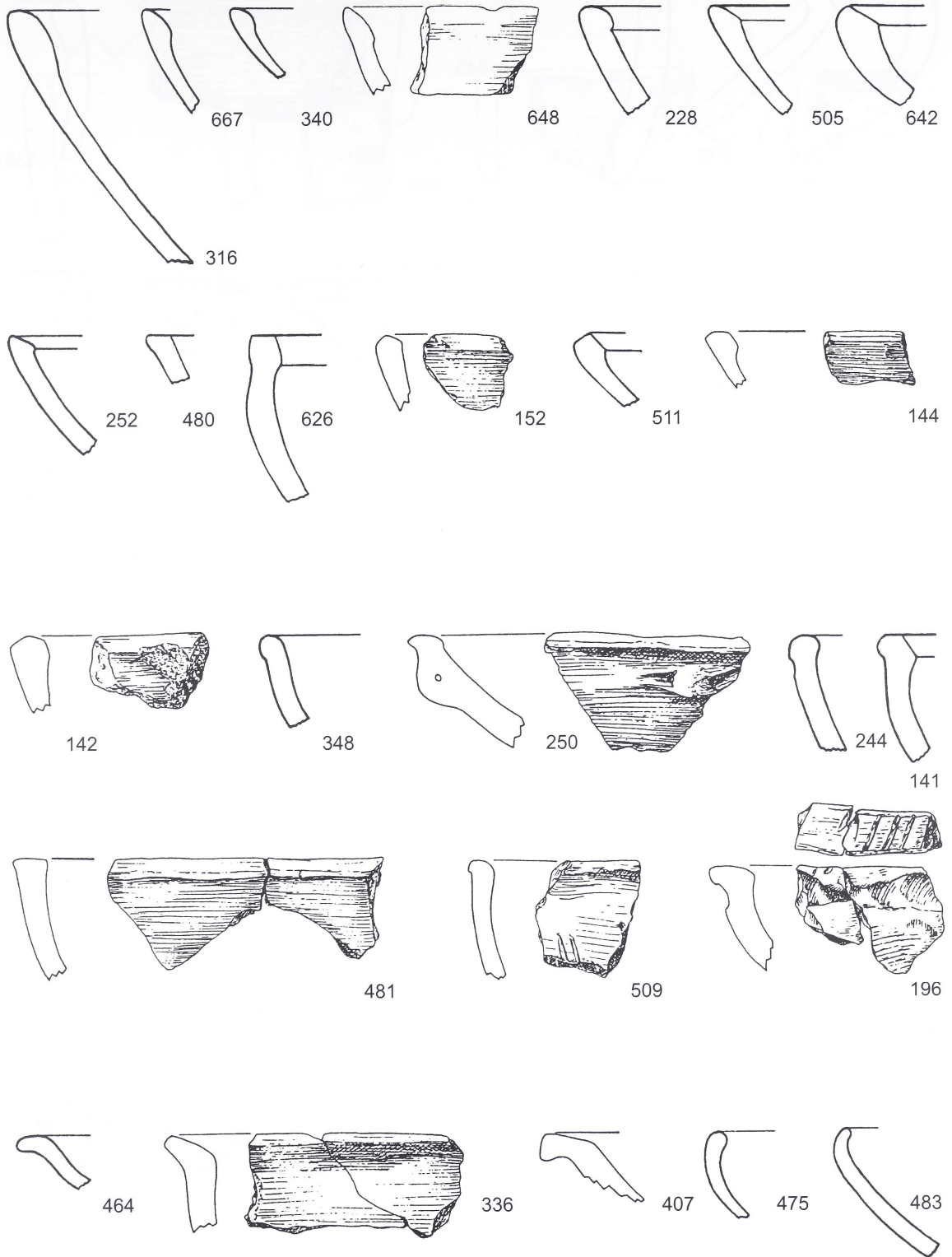

Rüthen-Kneblinghausen. Keramik aus der "Kulturschicht unter Walle". - M. 1:2.

TAFEL 74

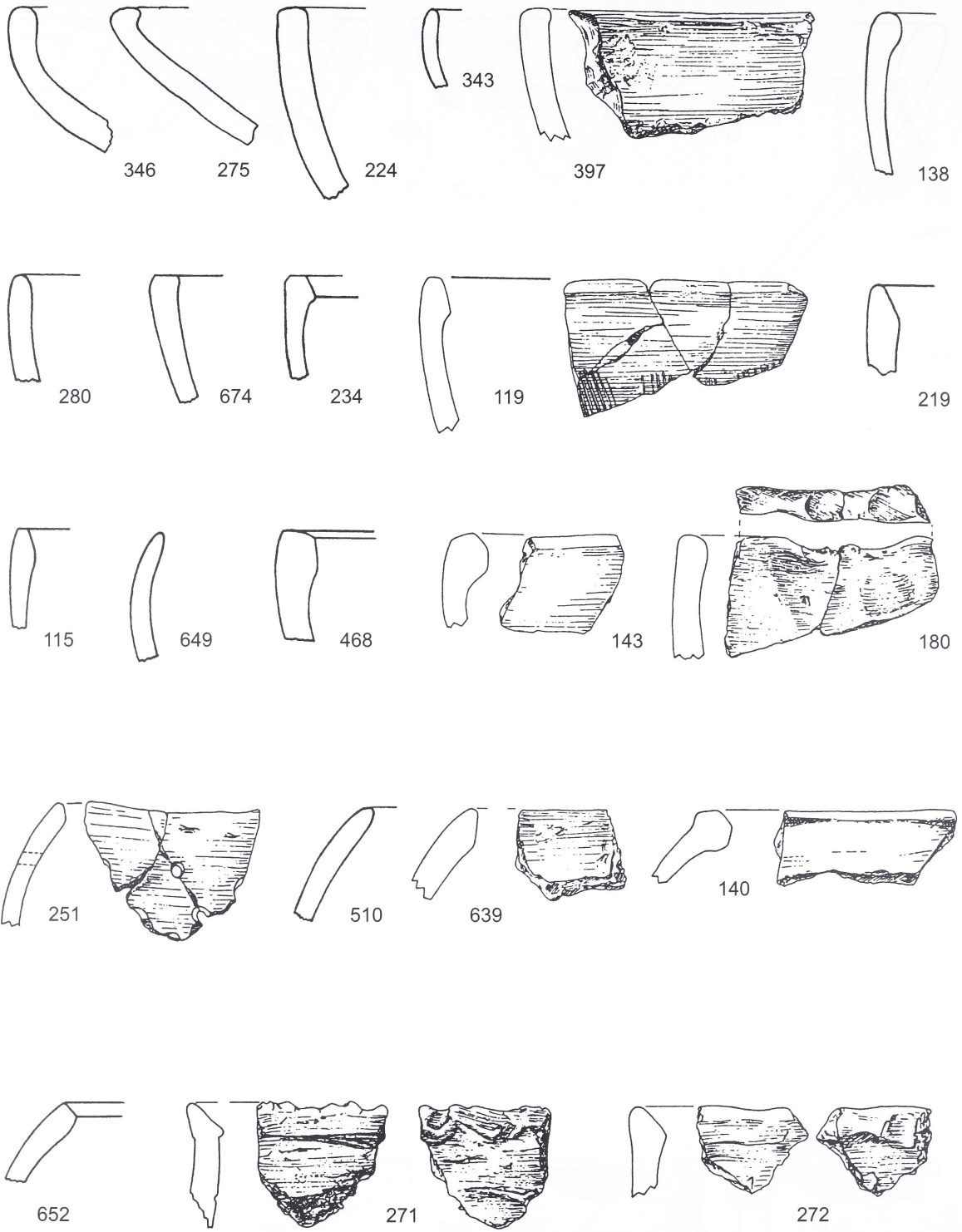

Rüthen-Kneblinghausen. Keramik aus der "Kulturschicht unter dem Walle". - M. 1:2.

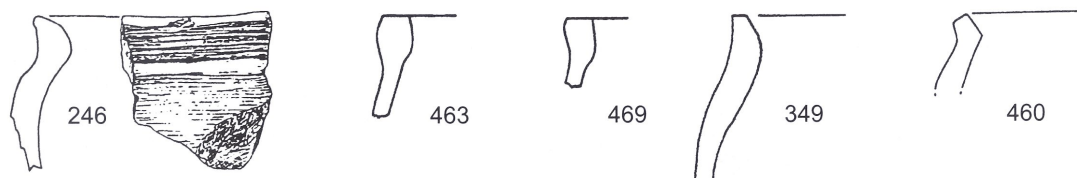
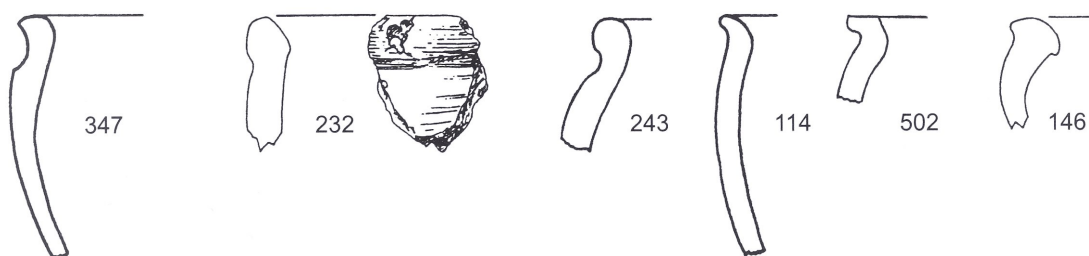
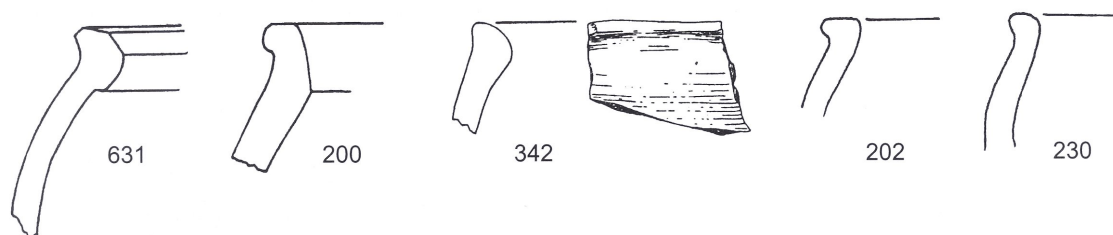
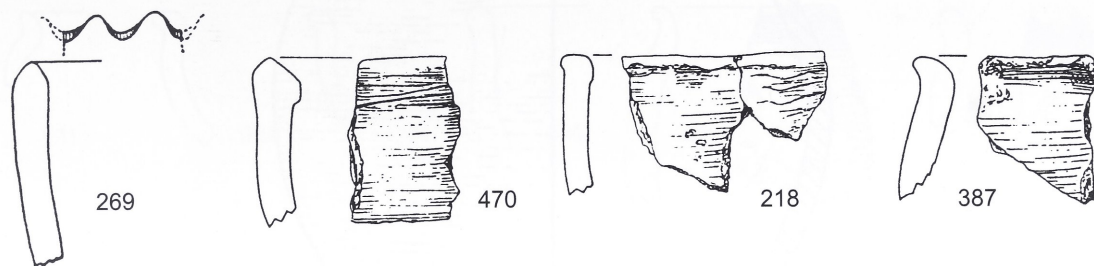

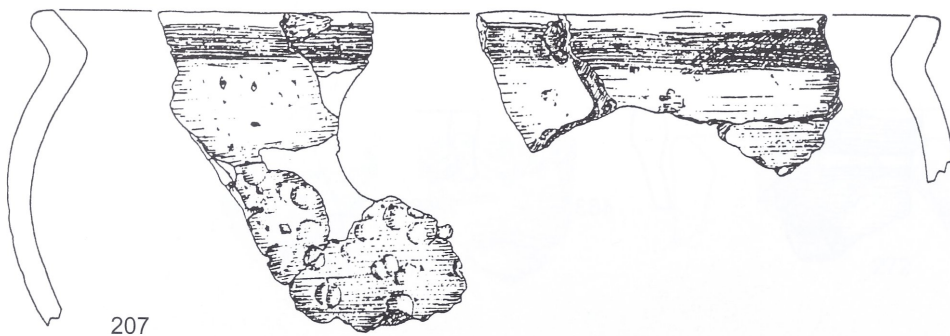
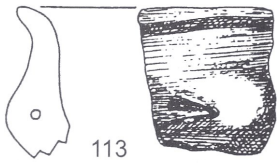
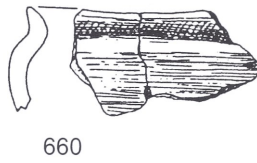
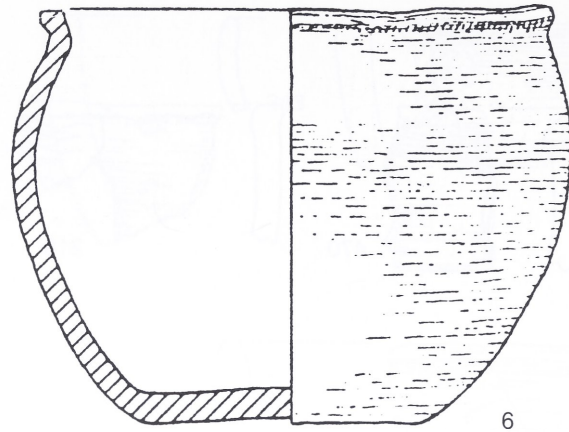

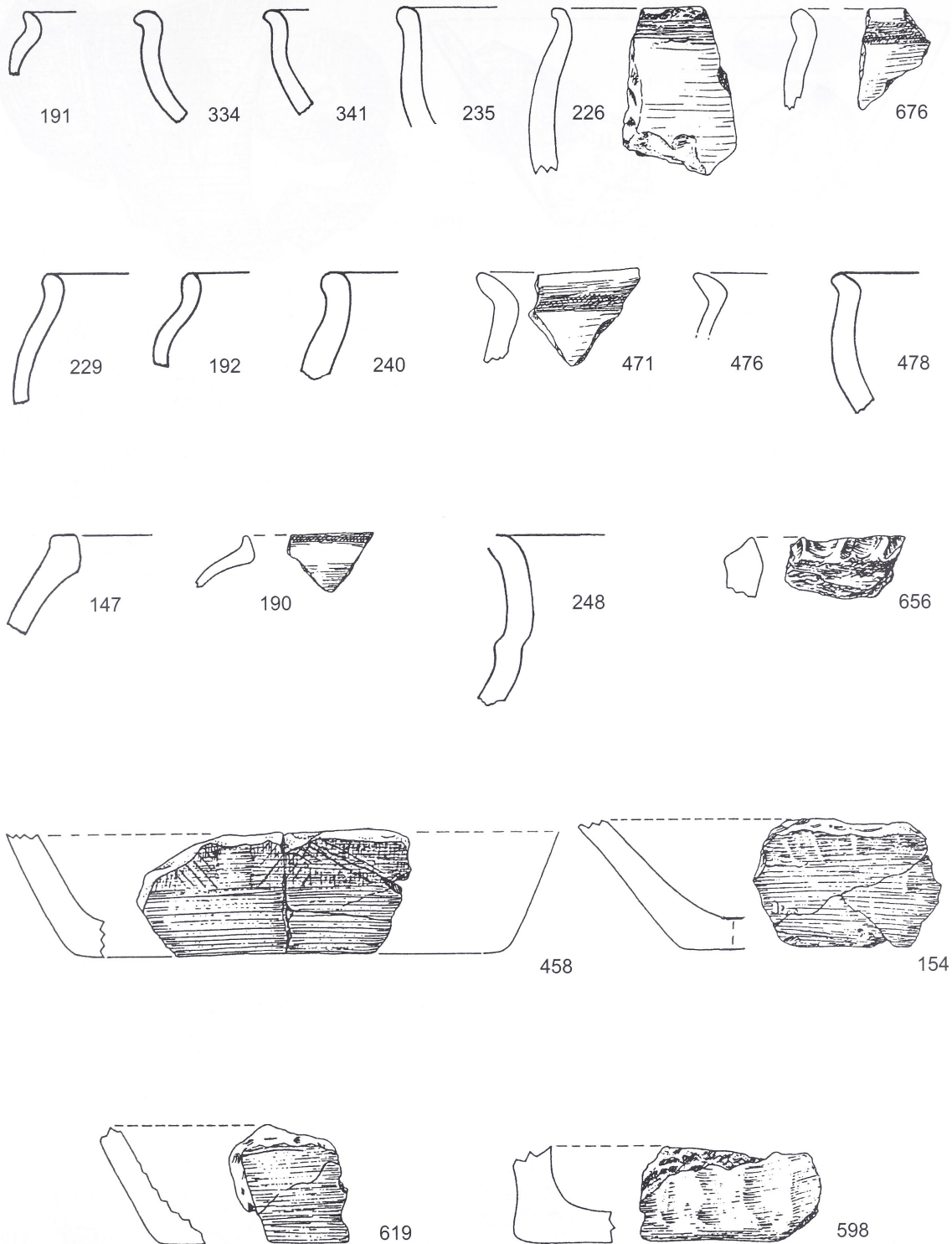

Rüthen-Kneblinghausen. Keramik aus der "Kulturschicht unter Walle". - M. 1:2.

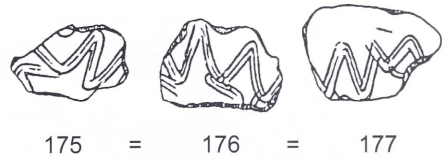
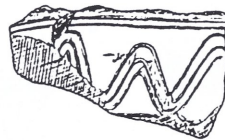
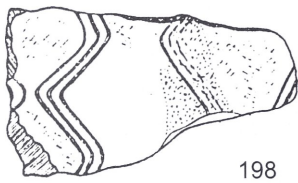
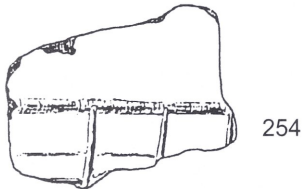
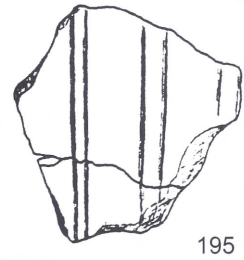
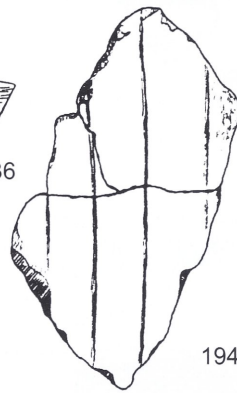
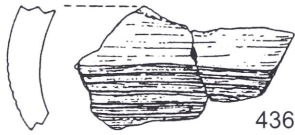
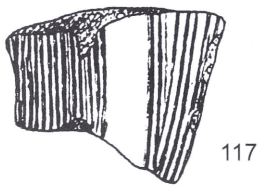
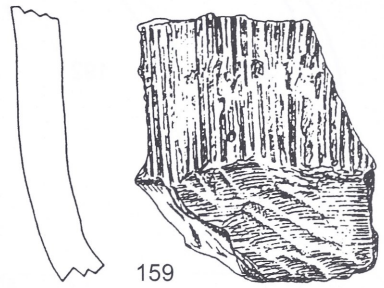
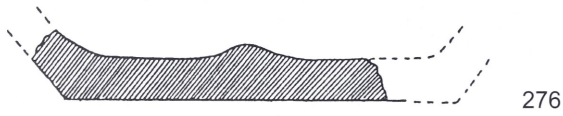
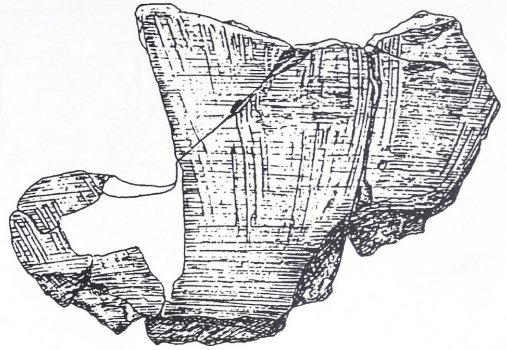
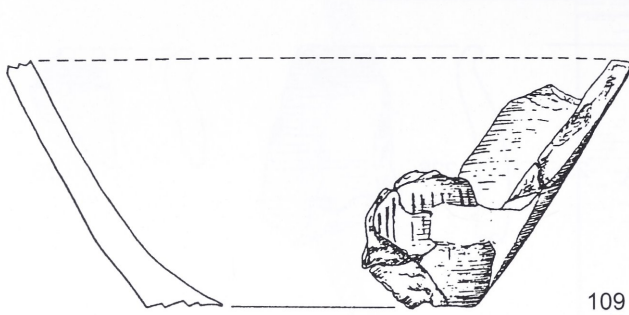

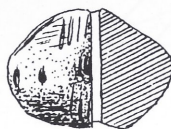
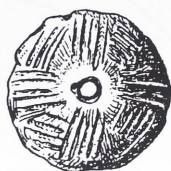
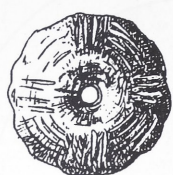

1

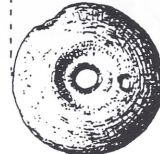
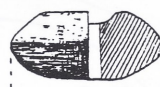

2

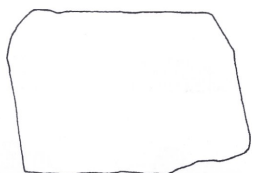
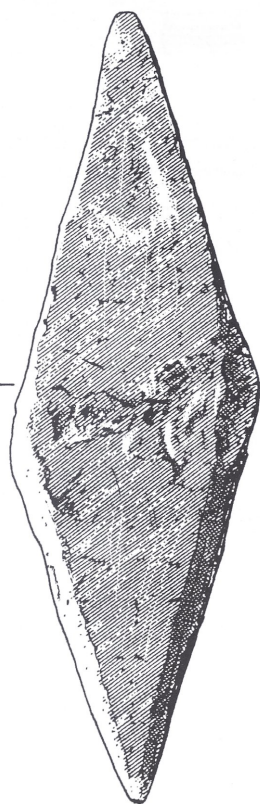

3

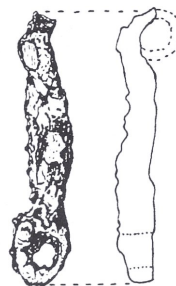

4

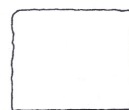

5

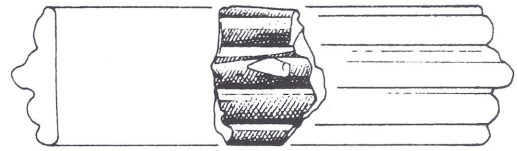
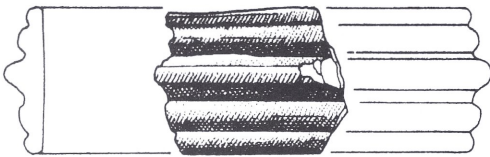
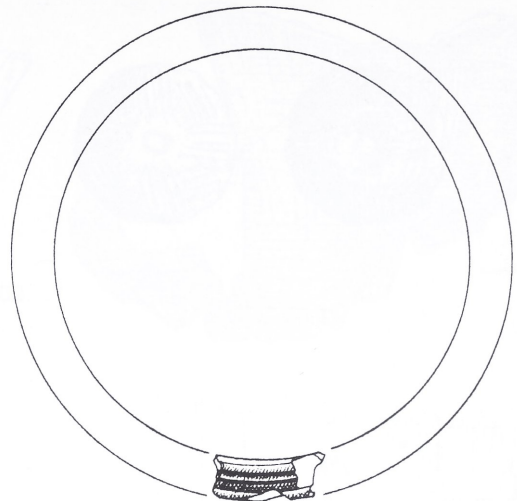
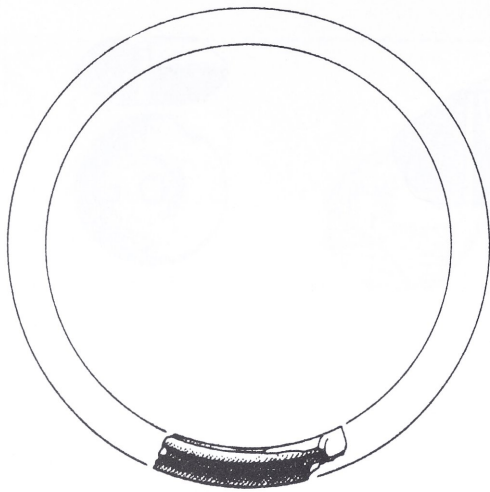

1

2

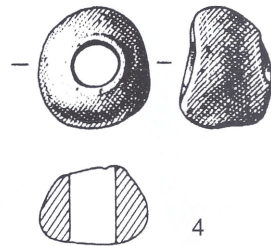
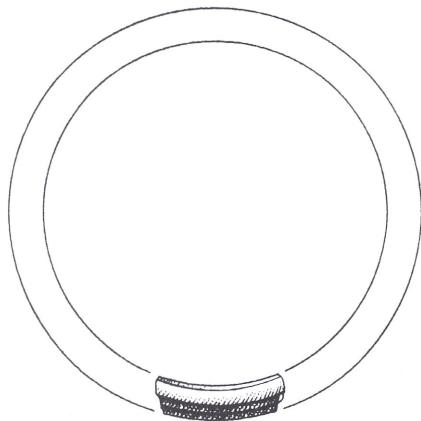

4

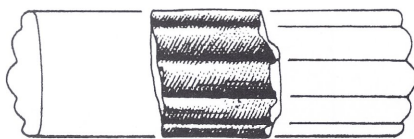

3



5a



5b



5c

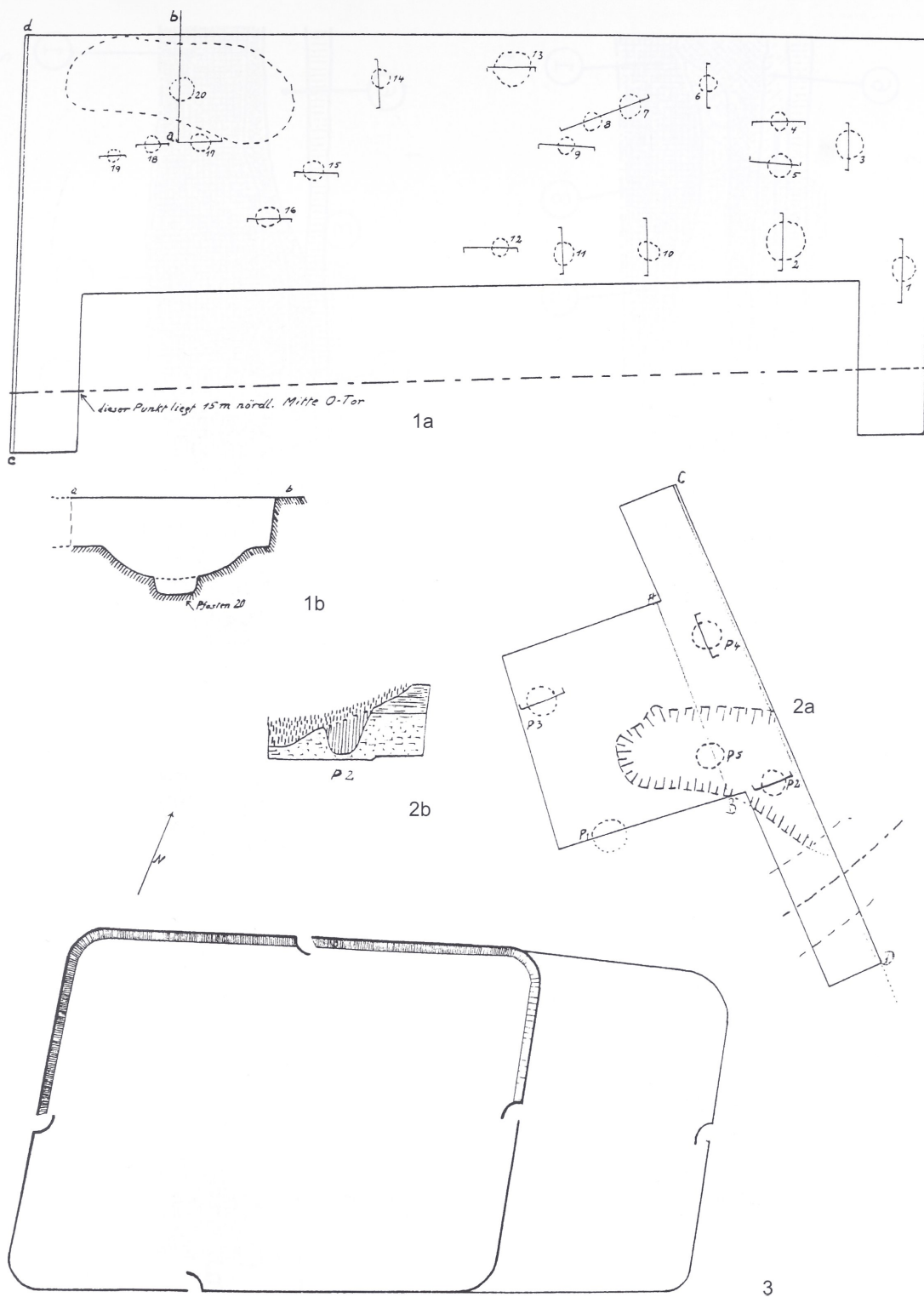

Rüthen-Kneblinghausen. 1a. Arbeitsfeld III O/1938, Planum; 1b. Grube 25 mit Pfosten 20, Profil; 2a. Arbeitsfeld V W/1938, Planum; 2b. Grube 34 mit Pfosten 2, Profil; 3. Verbreitung der "Kulturschicht unter dem Walle"; - 1a, 2a M. 1:100; 1b, 2b M. 1:40.

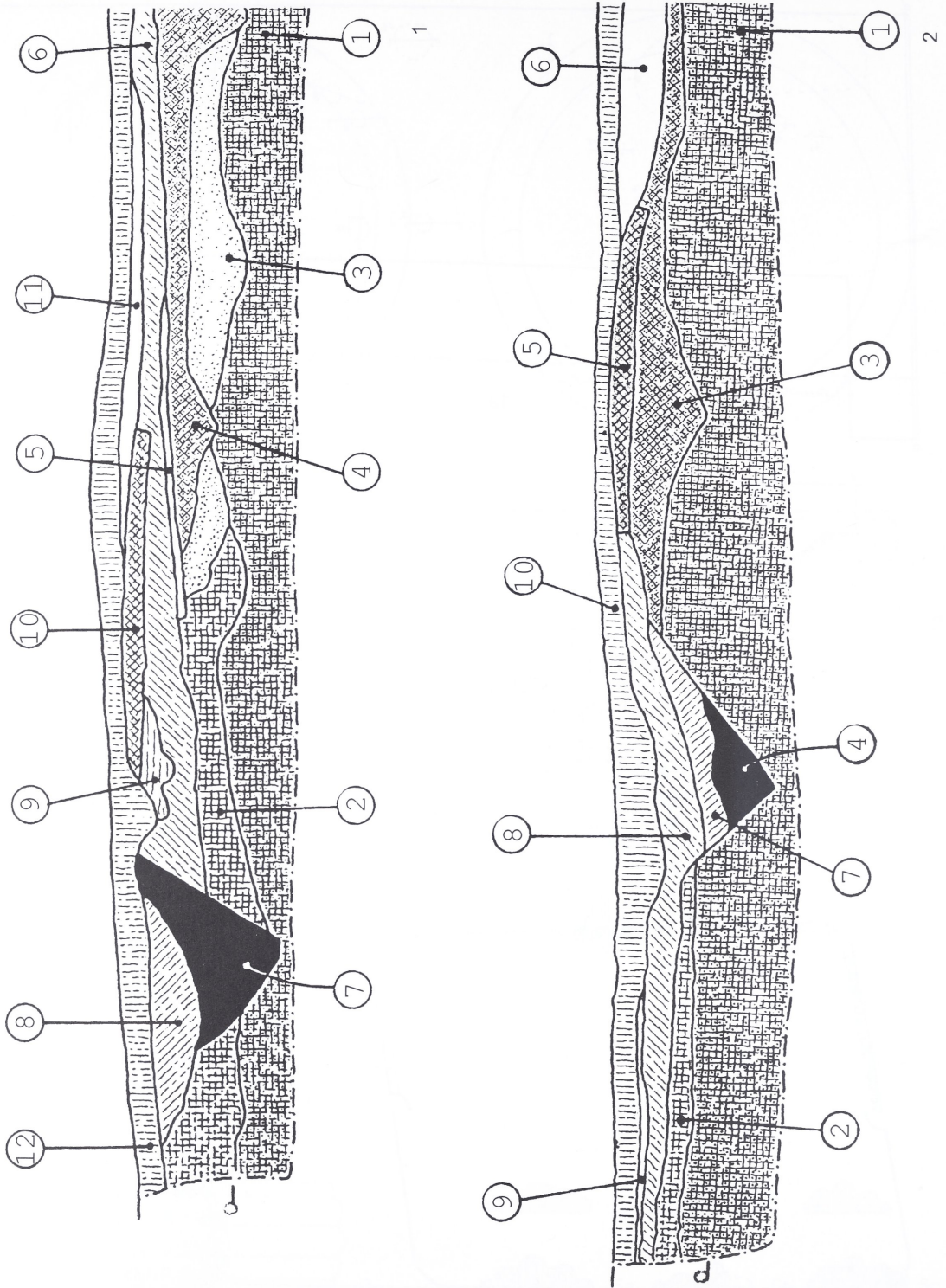

Rüthen-Kneblinghausen. 1. Profilschnitt C/1937, Schicht 10 entspricht "Kulturschicht unter dem Walle"; 2. Profilschnitt D/1937, Schicht 5 entspricht "Kulturschicht unter dem Walle". - M. 1:50.

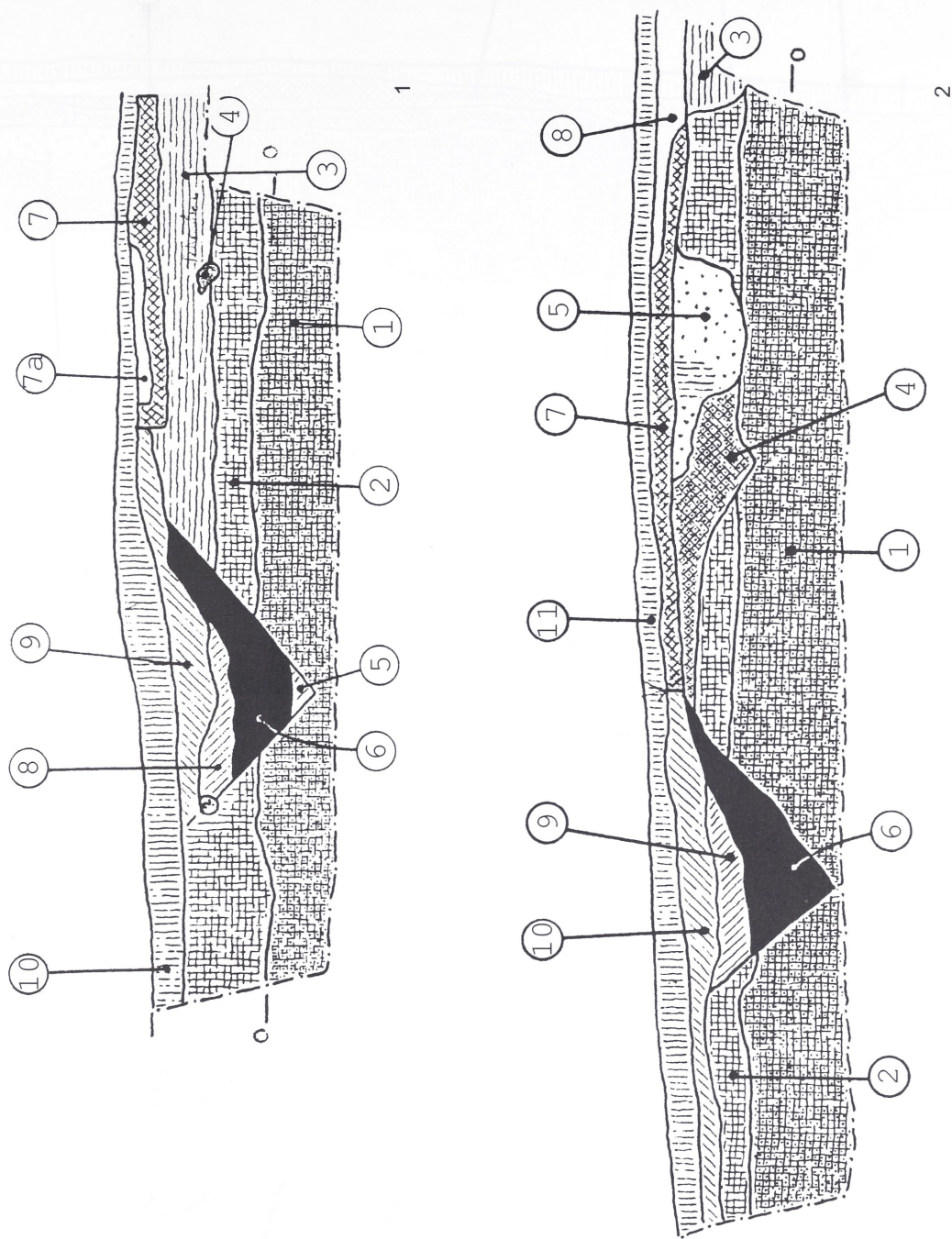

Rüthen-Kneblinghausen. 1. Profilschnitt E/1937, Schicht 7 entspricht "Kulturschicht unter dem Walle"; 2. Profilschnitt D/1937, Schicht 7 entspricht "Kulturschicht unter dem Walle". - M. 1:50.

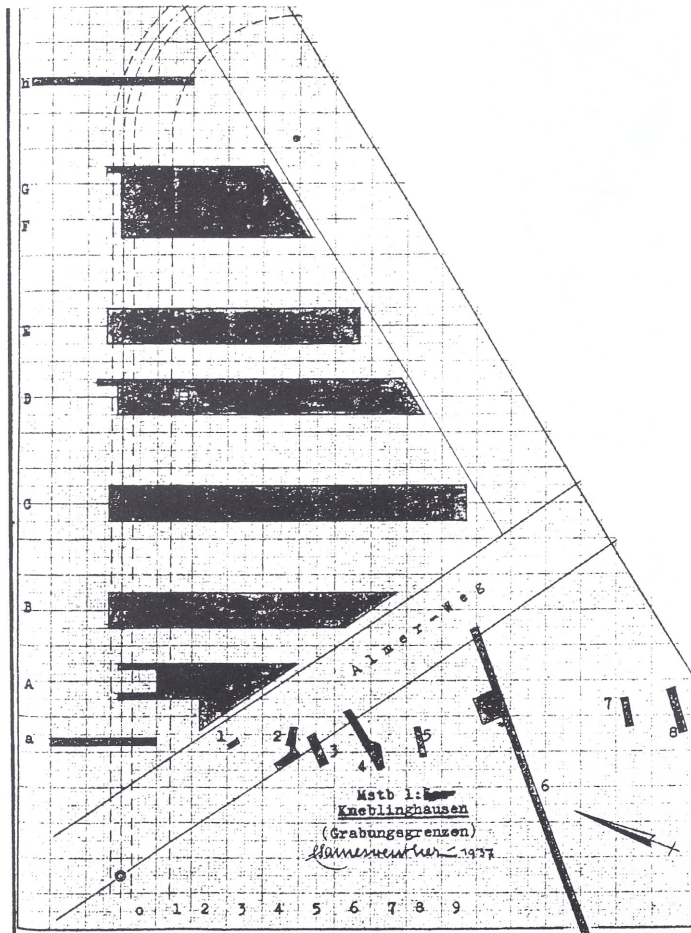
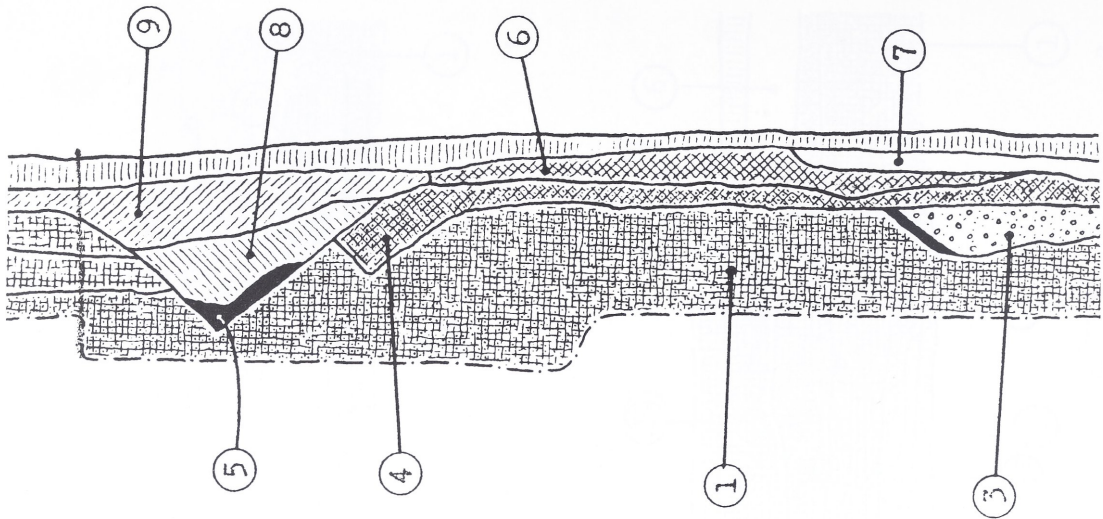

Rüthen-Kneblinghausen. 1. Profilschnitt h/1937, Schicht 6 entspricht "Kulturschicht unter dem Walle"; 2. Lage der Schnitte der Grabung Samesreuther 1937 - I. M. 1:50.



Sendenhorst-Albersloh-Alst (Mkz. 4112,22). Gesamtplan der Grabung.

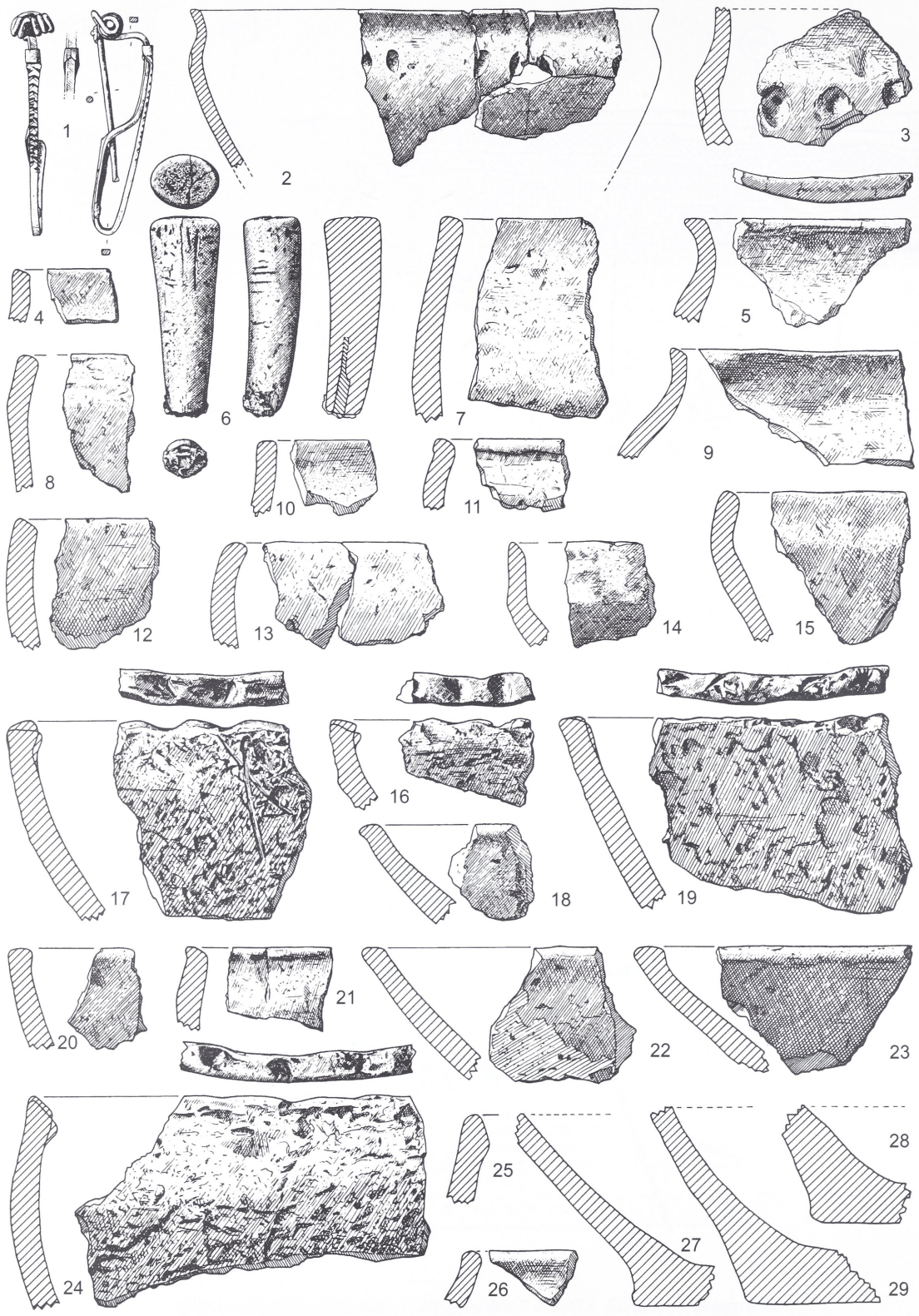

Oelde-Sünninghausen (Mkz. 4215,3-4). Gr. 39. - Bronze, Geweih, Keramik M. ca. 1:2.

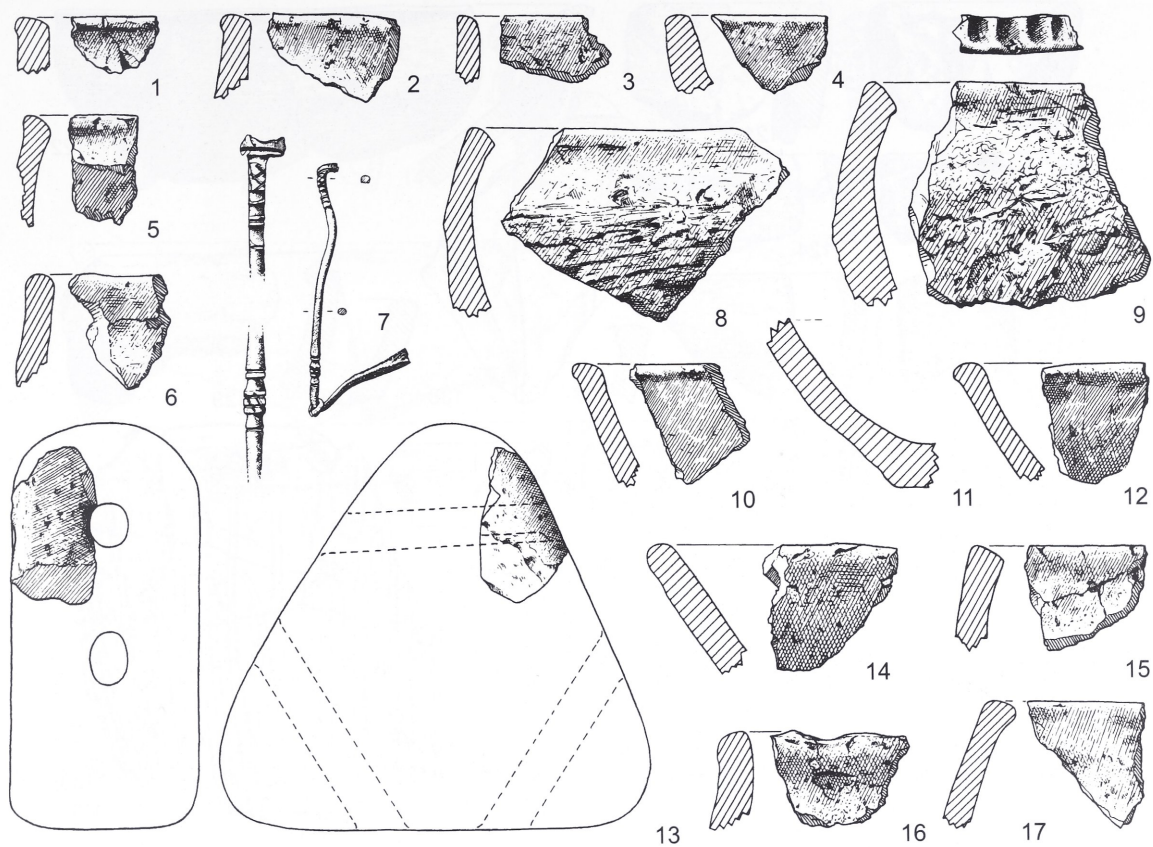

Oelde-Sünninghausen (Mkz. 4215/3-4). Gr. 66. - Bronze, Keramik M. 1:2.

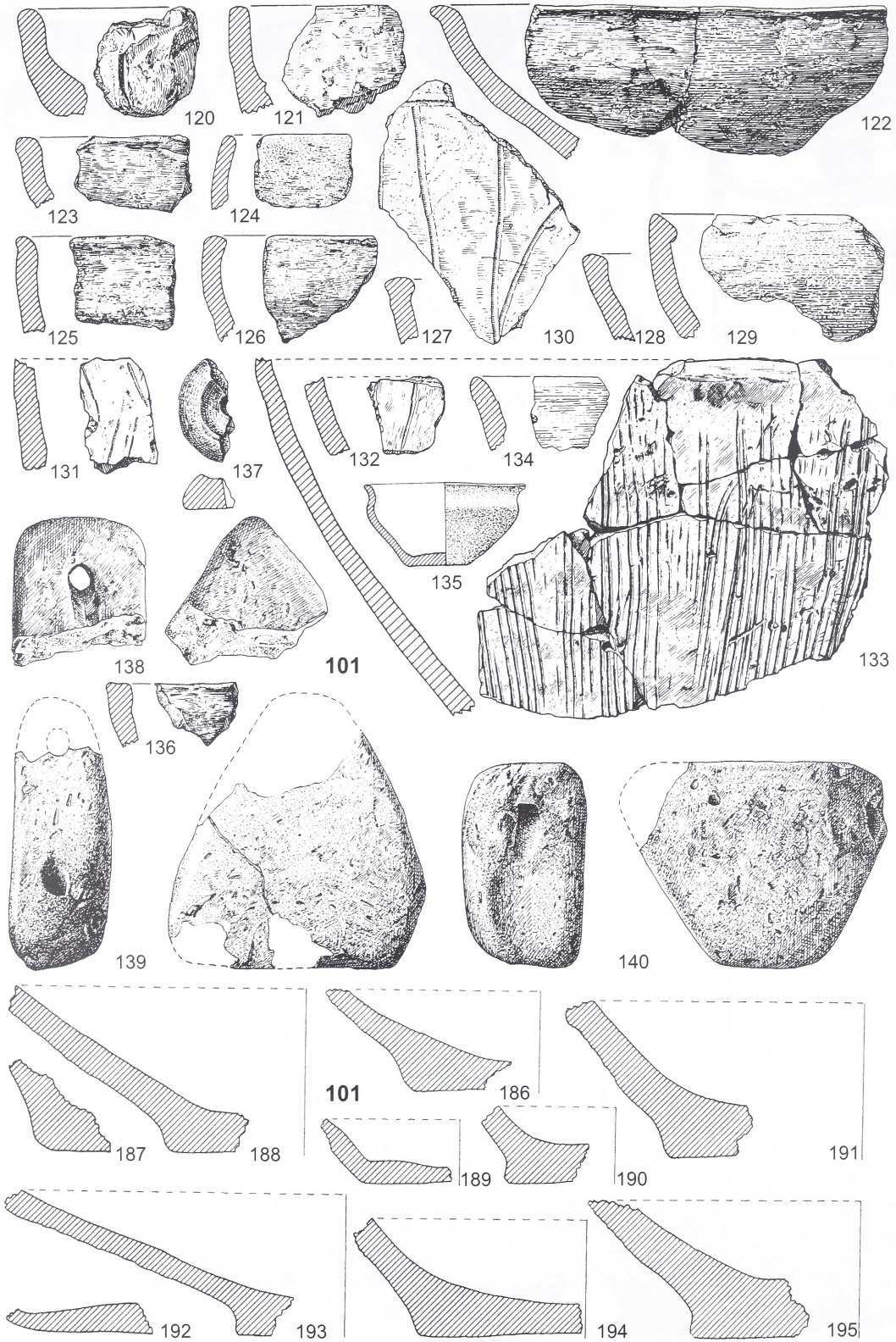

Oelde-Sünninghausen (Mkz. 4215,3-4). Gr. 101. - Bronze, Geweih, Keramik M. ca. 1:4.

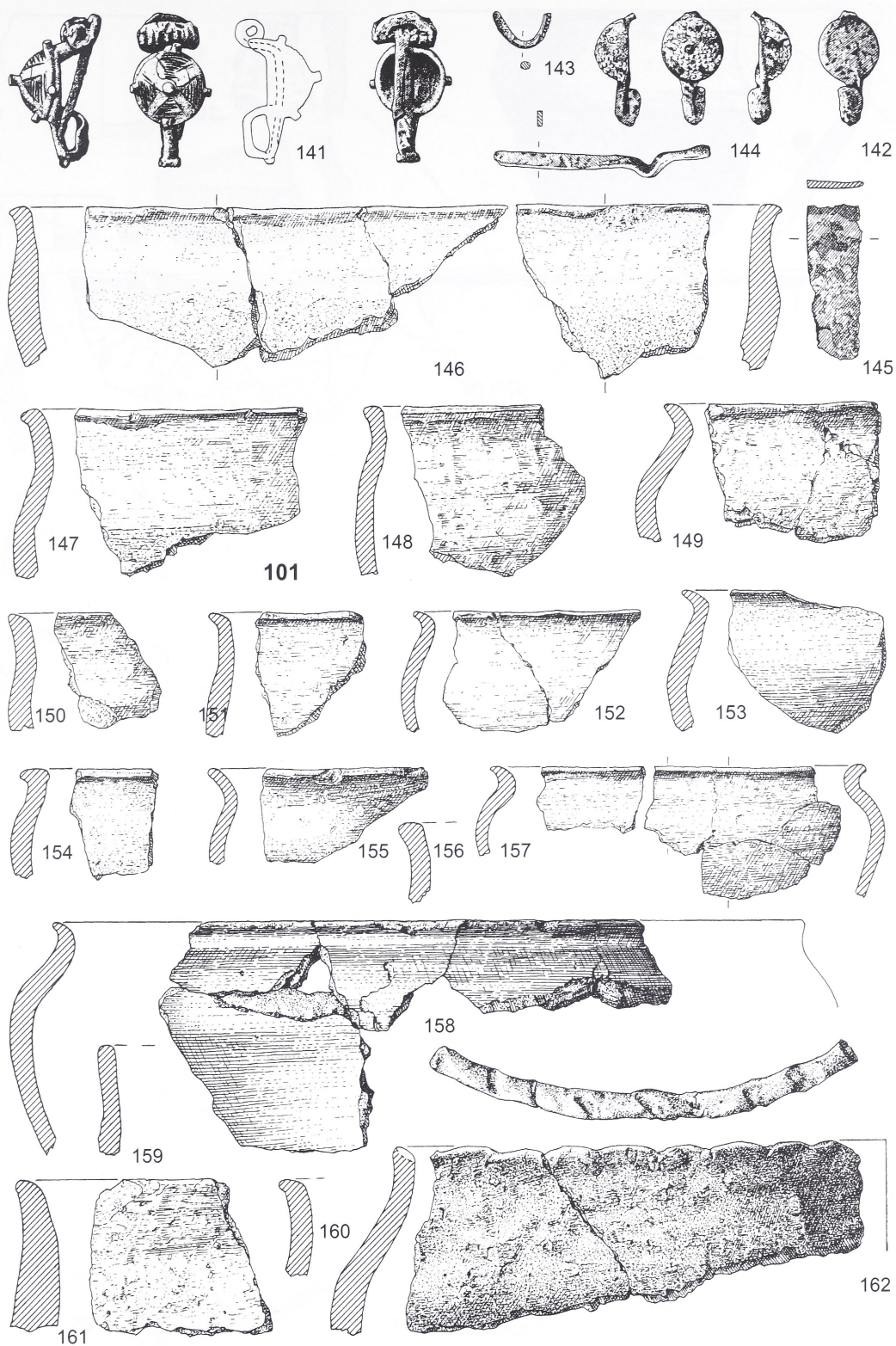

Oelde-Sünninghausen (Mkz. 4215/3-4). Gr. 101. - Eisen, Bronze, Keramik M. ca. 1:2.

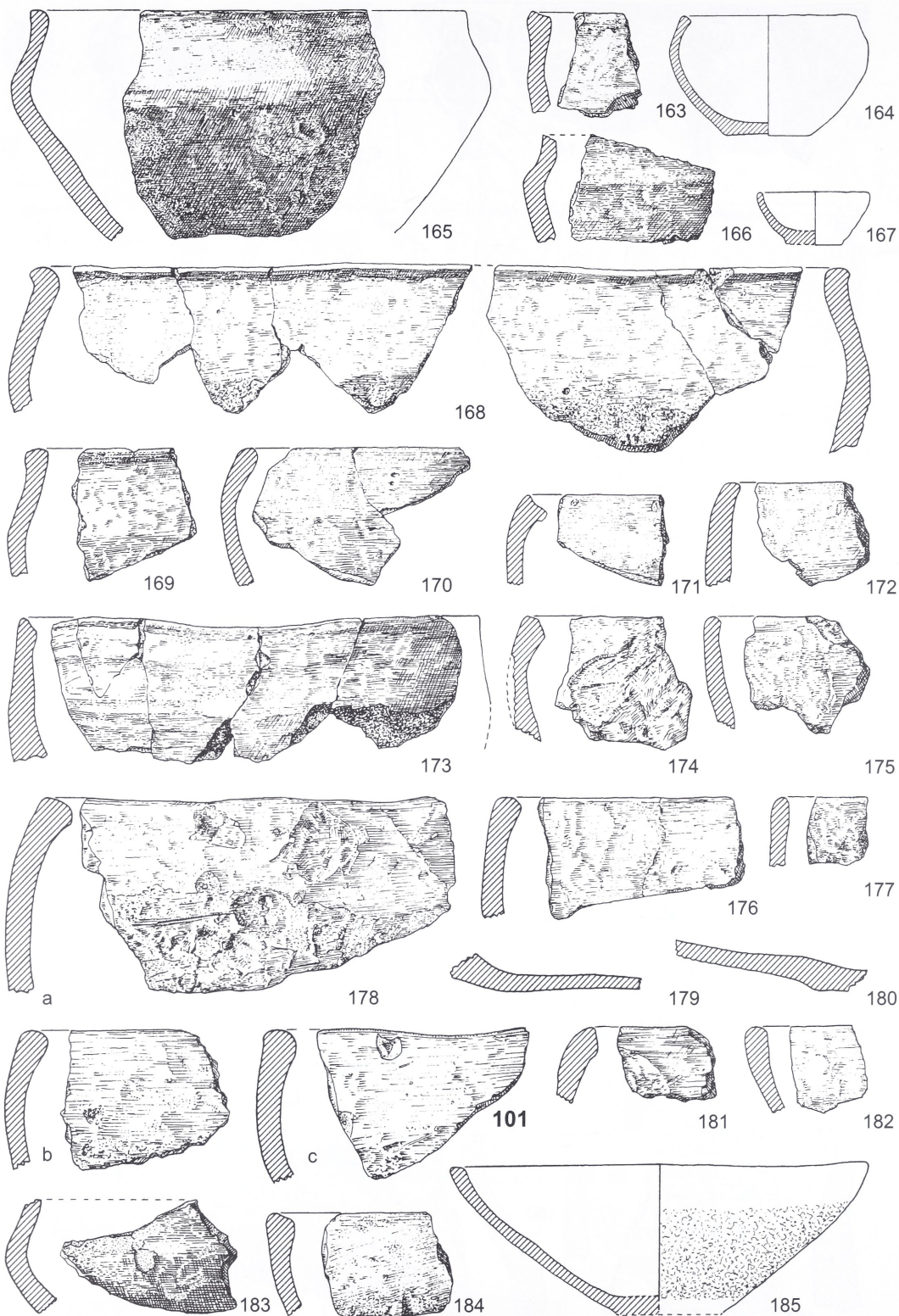

Oelde-Sünninghausen (Mkz. 4215,3-4). Gr. 39. - Bronze, Geweih, Keramik M. ca. 1:2.

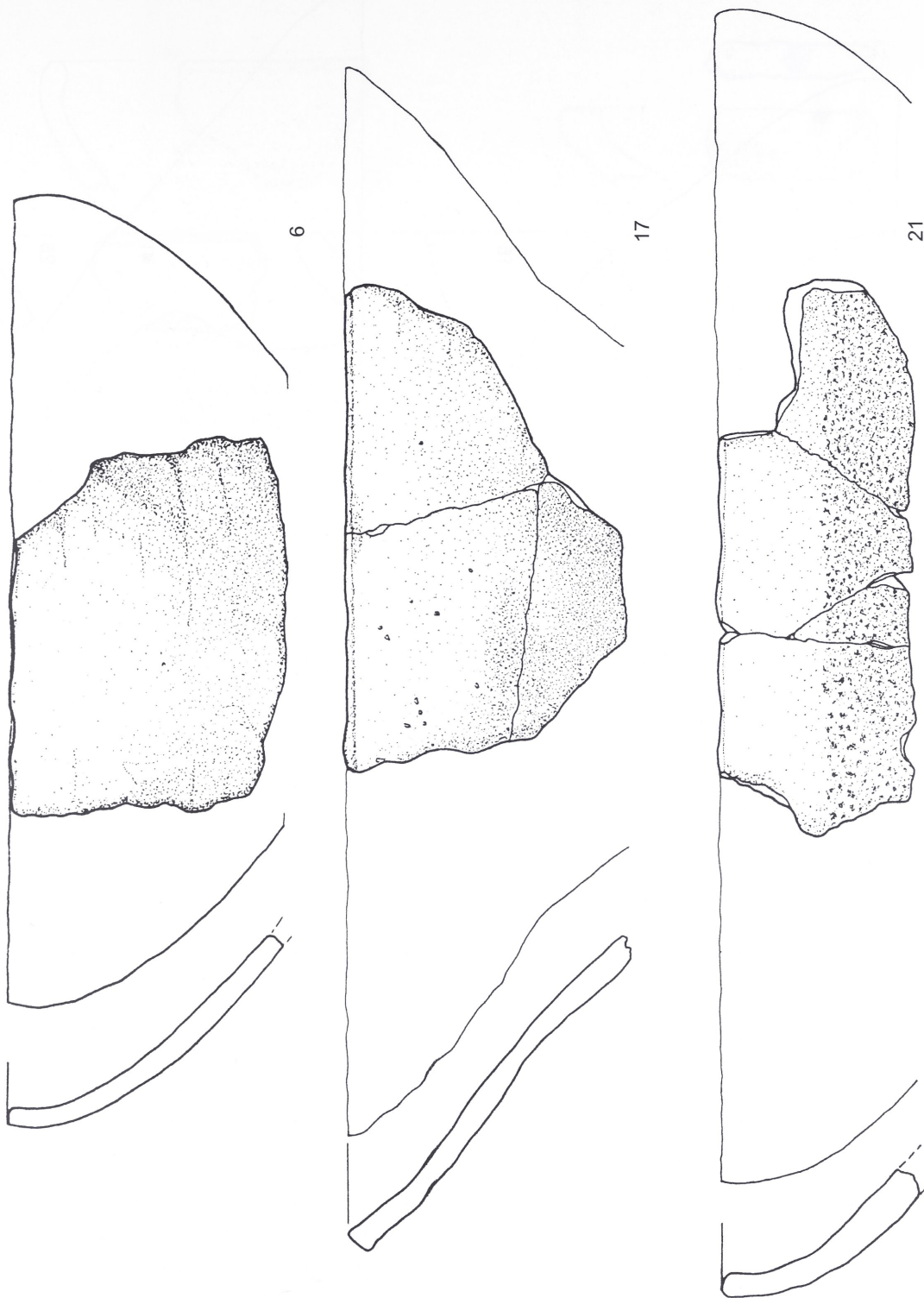

Bad Lippspringe, Burgstraße (Dkz. 4218/140). Gr. A1/1994. - Keramik M. 1:2.

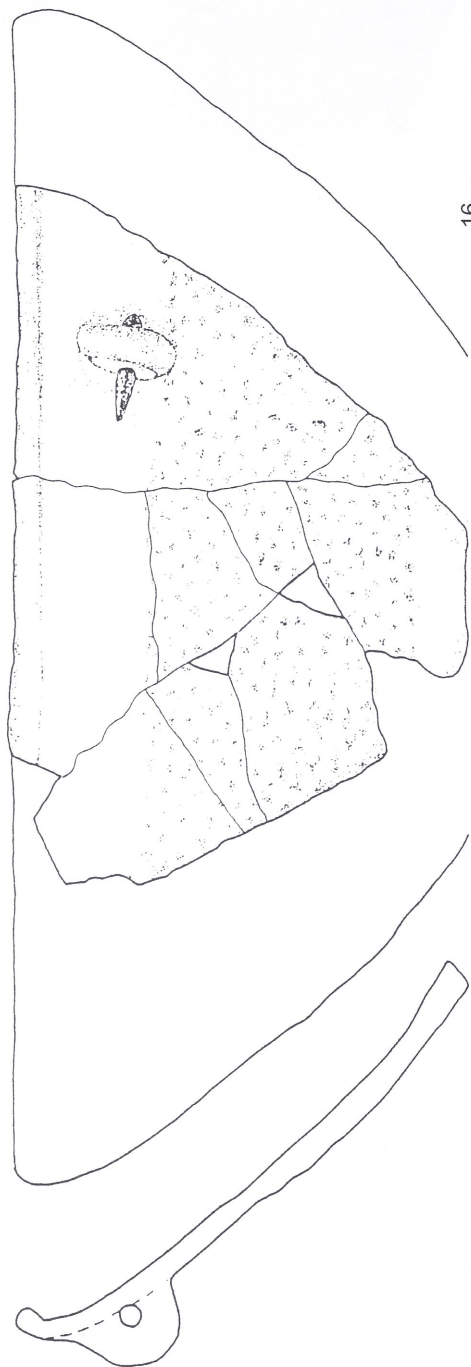

16

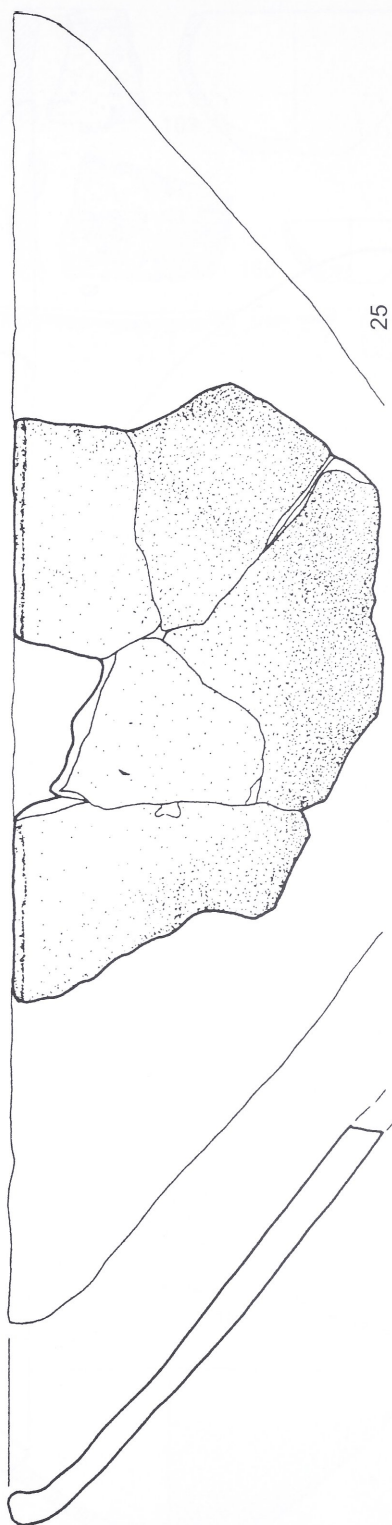

25

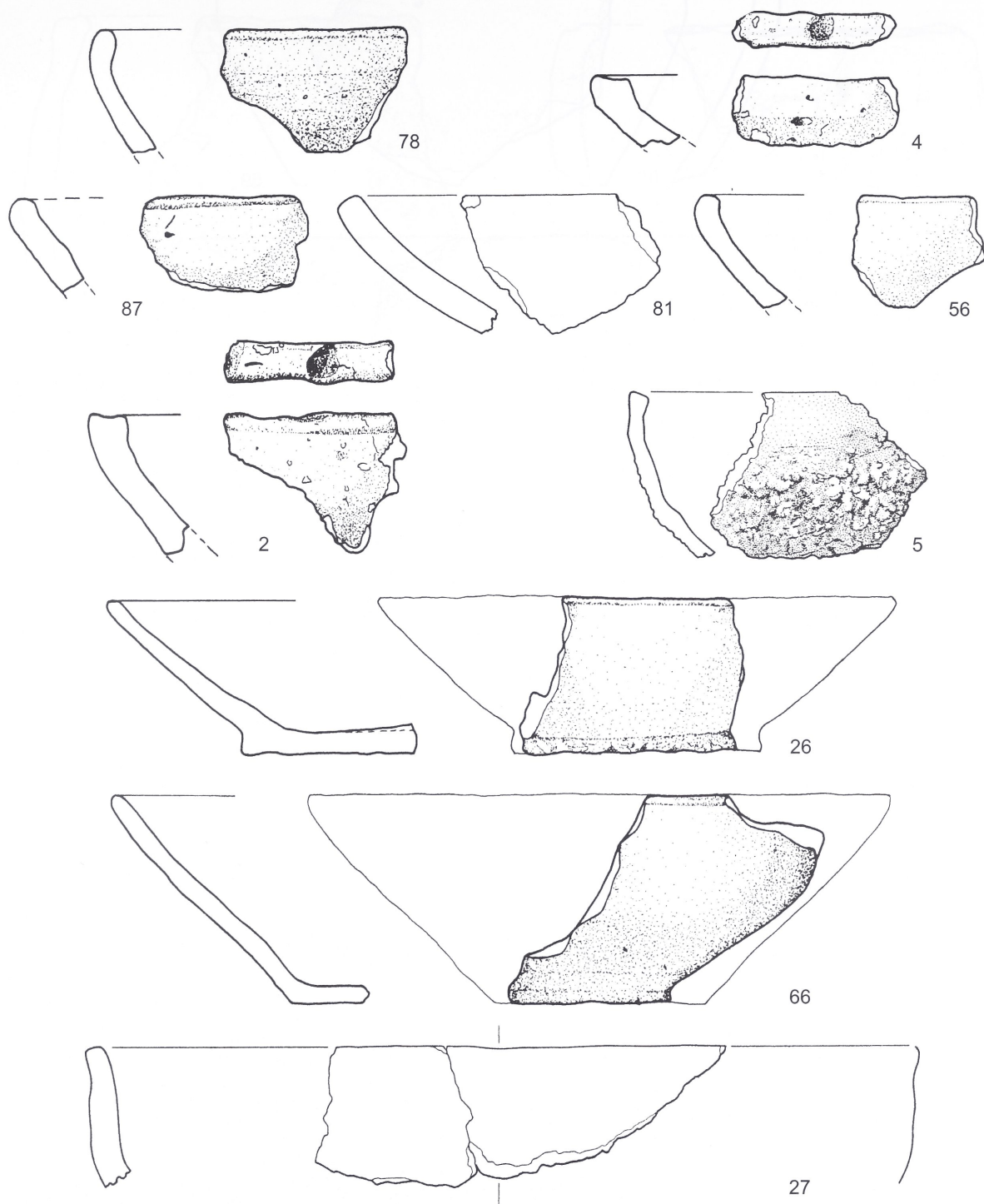

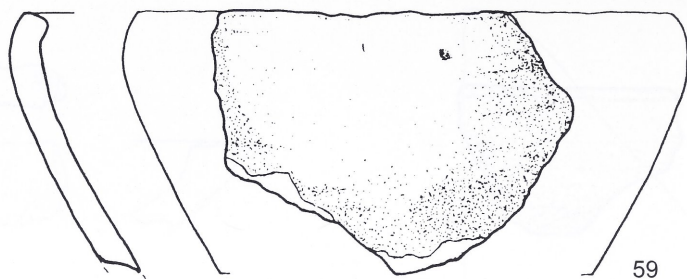

59

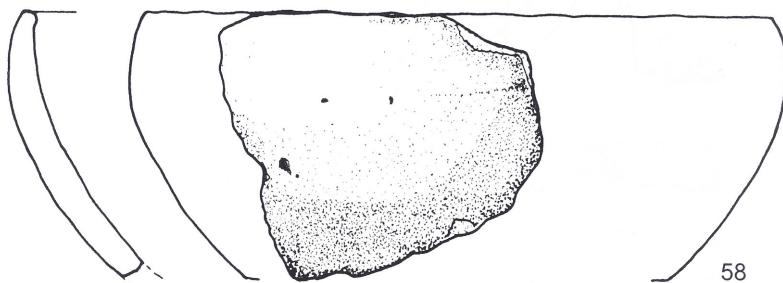

58

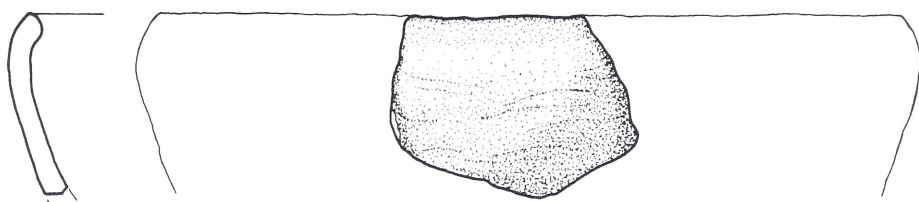

57

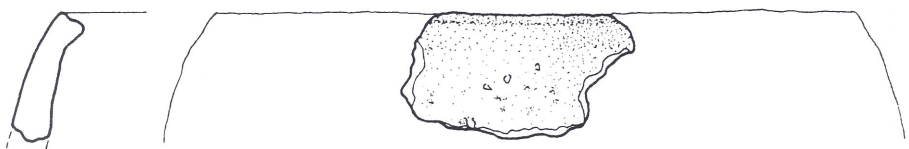

43

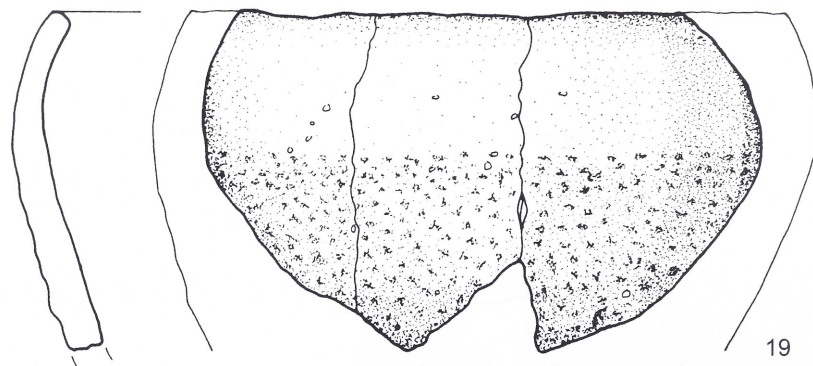

19

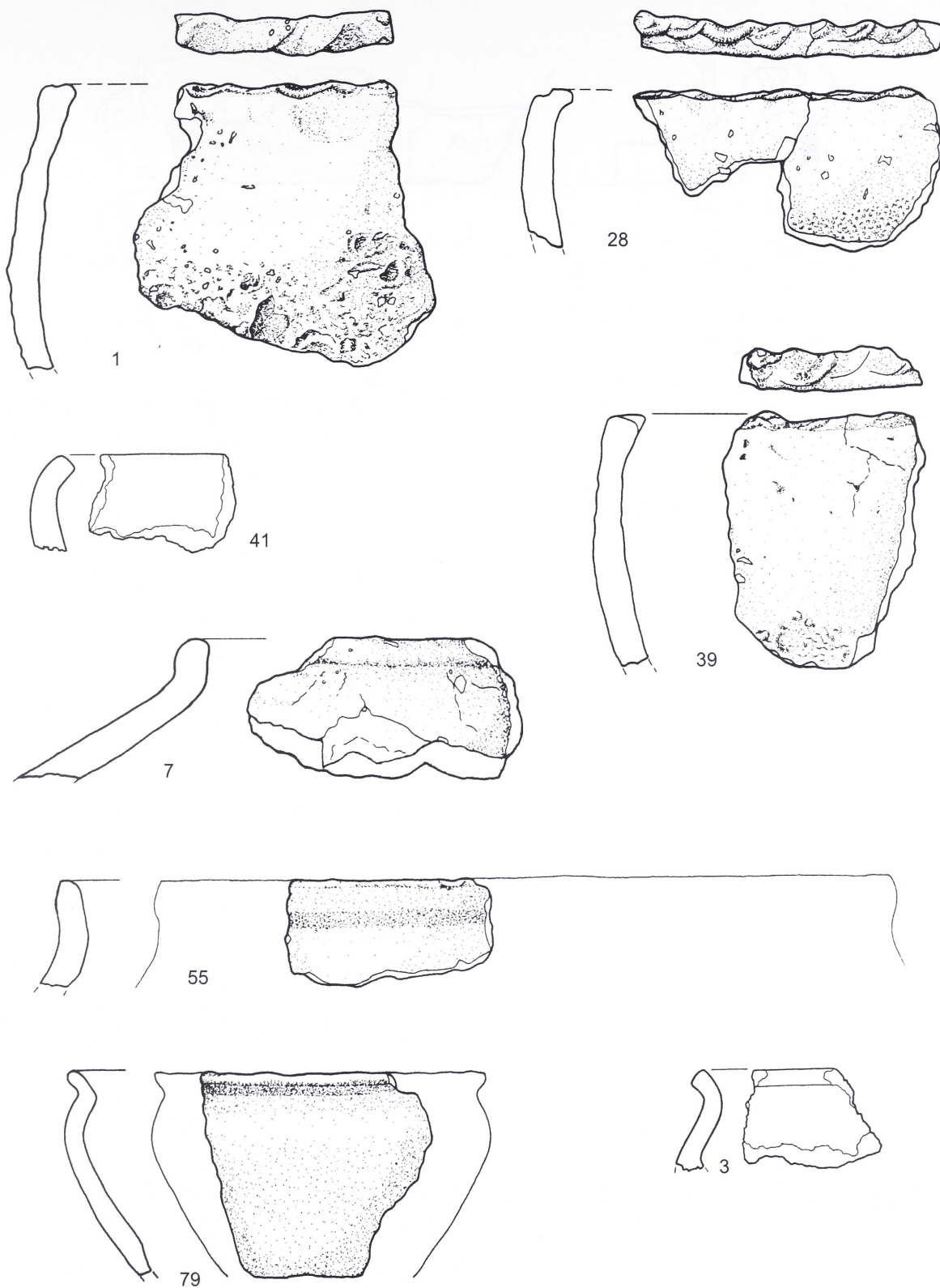

Bad Lippspringe, Burgstraße (Dkz. 4218/140). Gr. A1/1994. - Keramik M. 1:2.

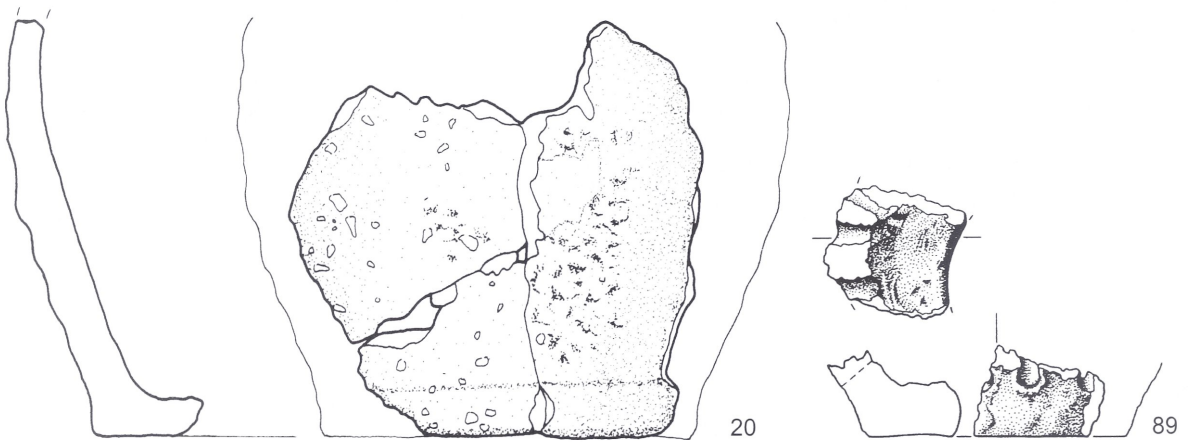
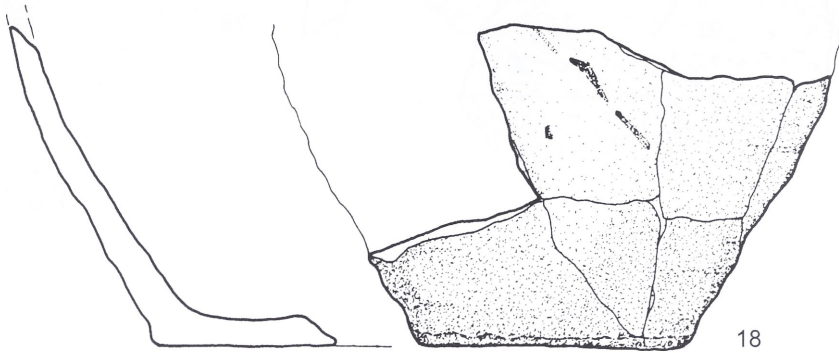
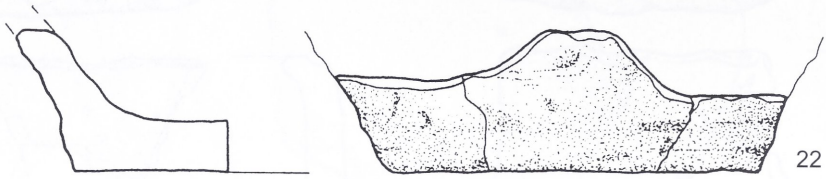

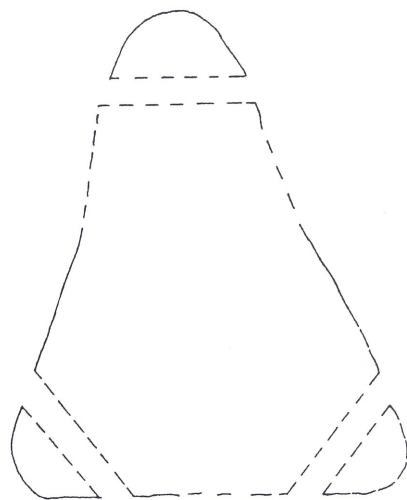
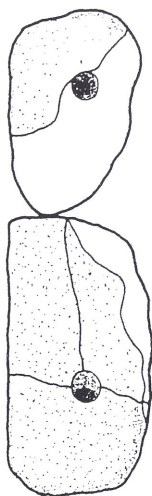
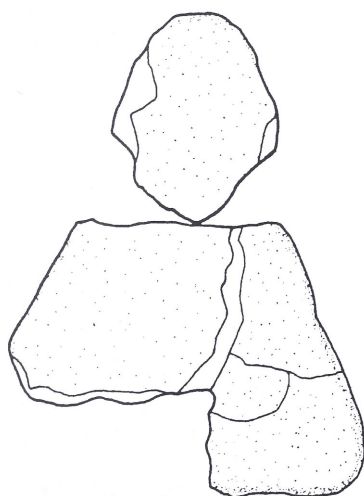
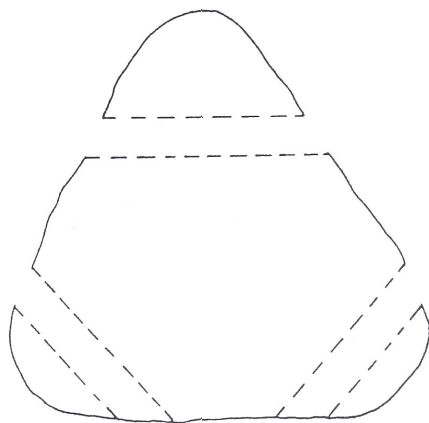
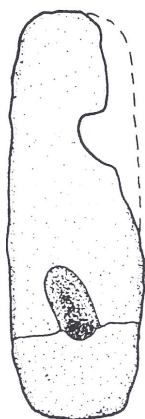
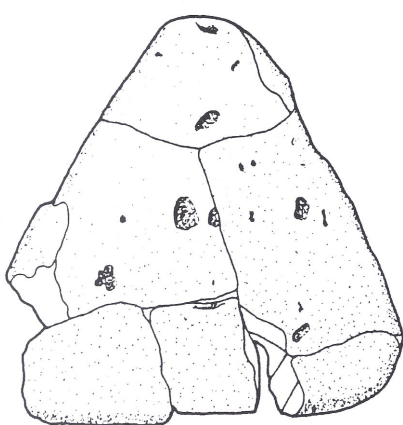
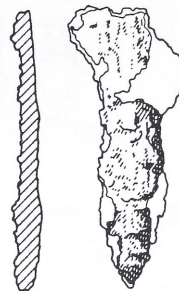
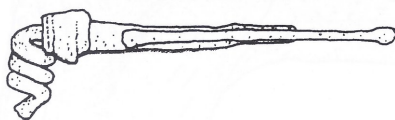
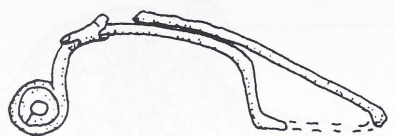

Bad Lippspringe, Burgstraße (Dkz. 4218,140). Gr. A1/1994. - Bronze M. 1:1; Eisen, Keramik M. 1:2.

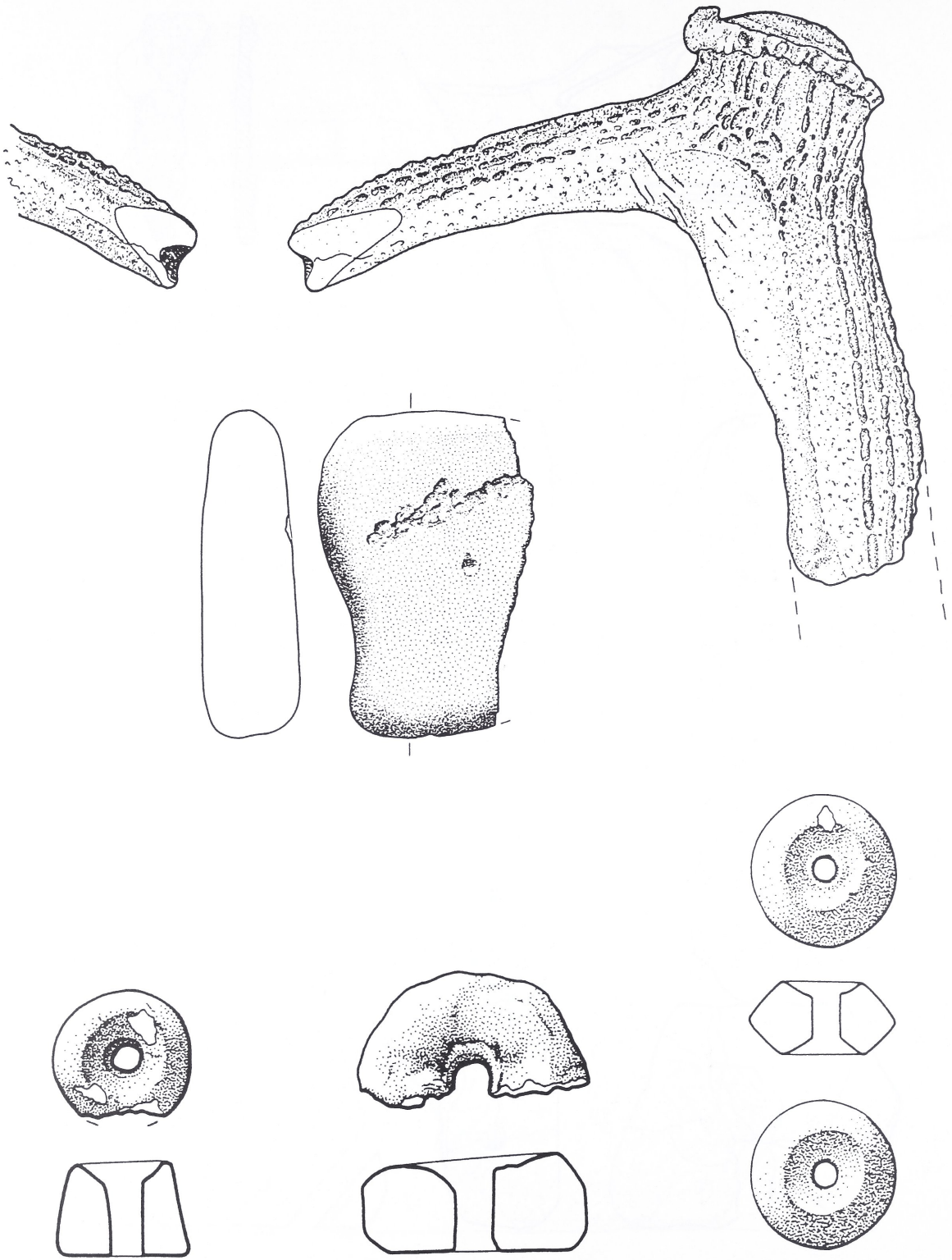

Bad Lippspringe, Burgstraße (Dkz. 4218,140). Gr. A1/1994. - Geweih, Stein M. 1:2; Keramik M. 1:1.

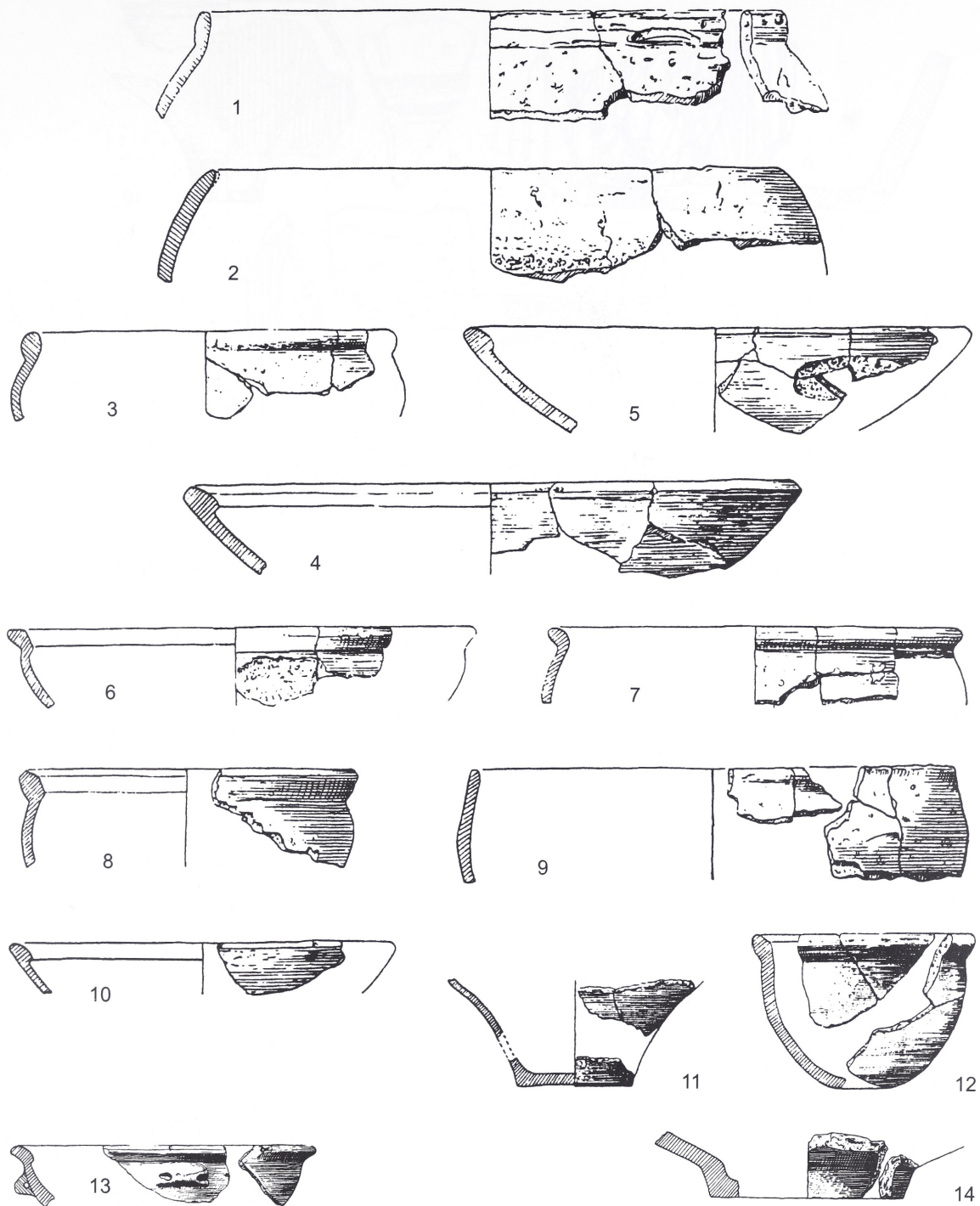

Bochum-Hiltrop (Akz. 4409,92). Bef. 40. - Keramik M. 1:4.

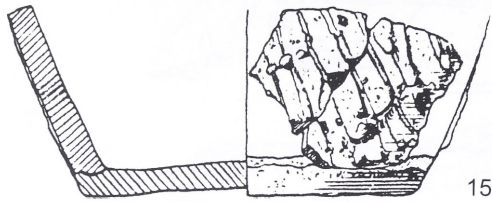

15

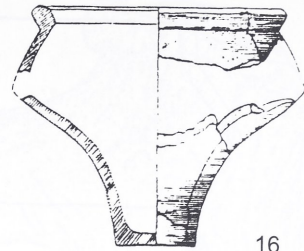

16

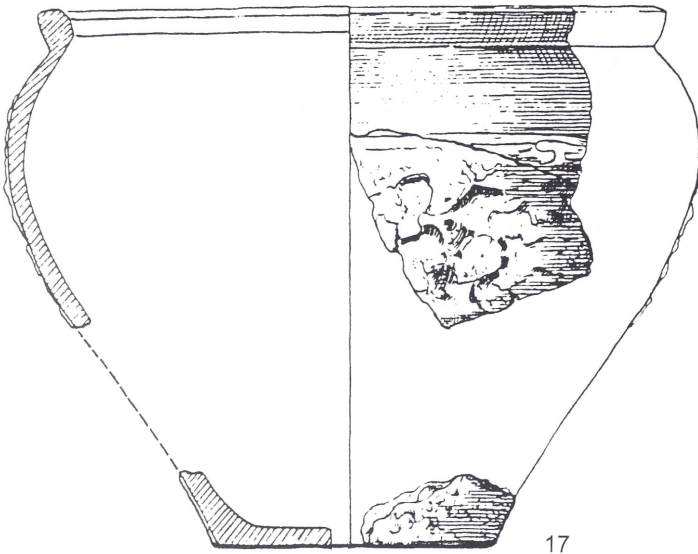

17

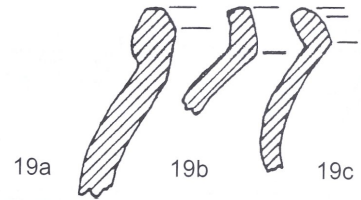

19a

19b

19c

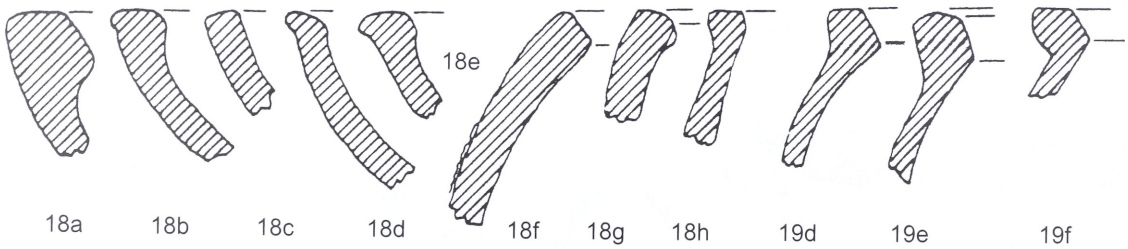

18a

18b

18c

18d

18e

18f

18g

18h

19d

19e

19f

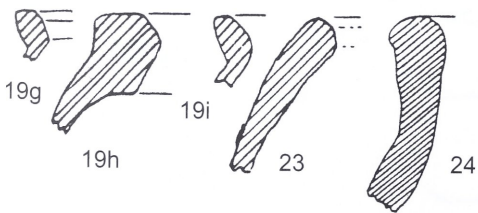

19g

19h

19i

23

24

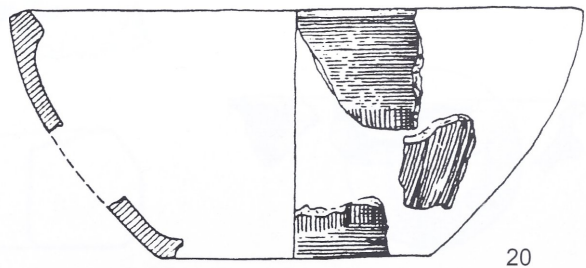

20

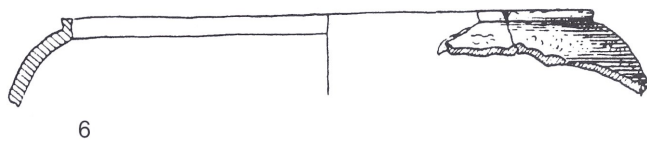
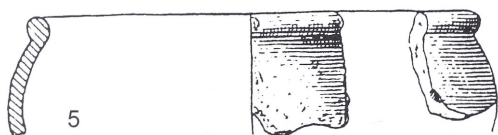
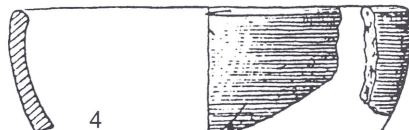
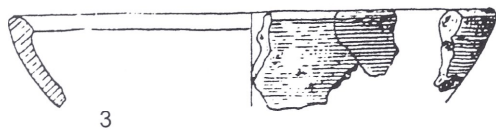
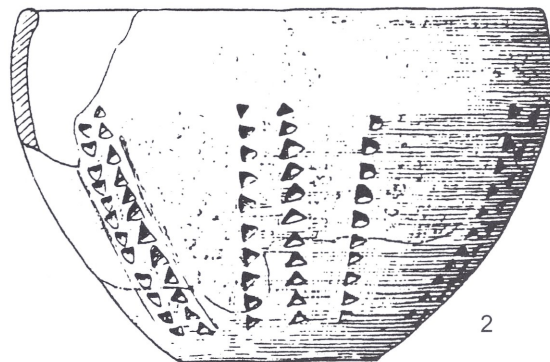
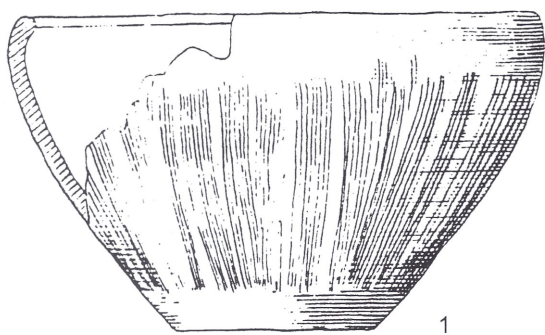
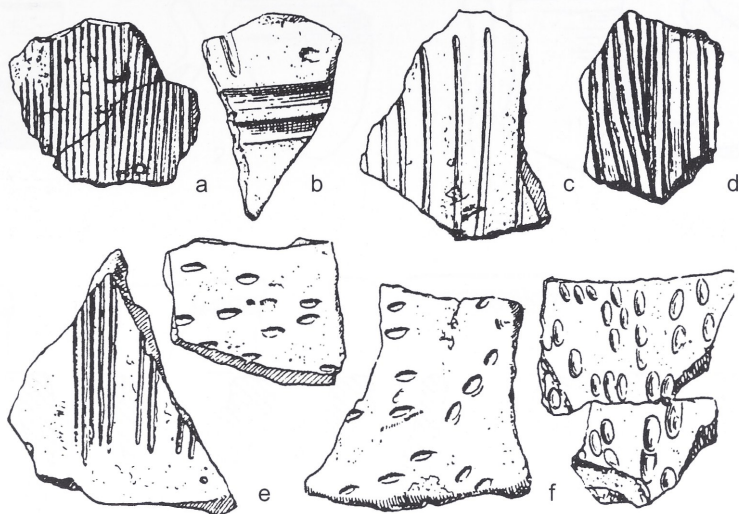

Bochum-Hiltrop (Akz. 4409,92). Bef. 40. - Keramik, a-f M. 1:2; übrige M. 1:4.

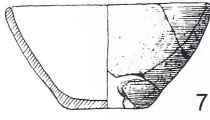

7

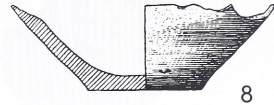

8

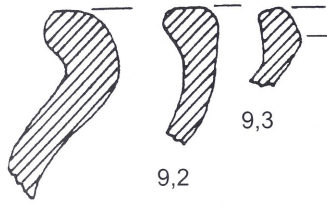

9,1

9,2

9,3

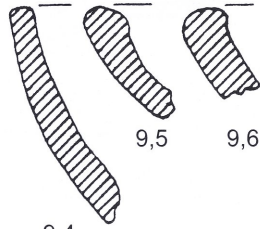

9,4

9,5

9,6

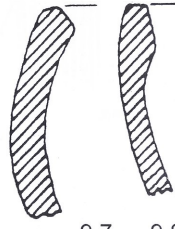

9,7

9,8

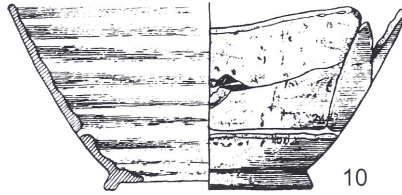

10

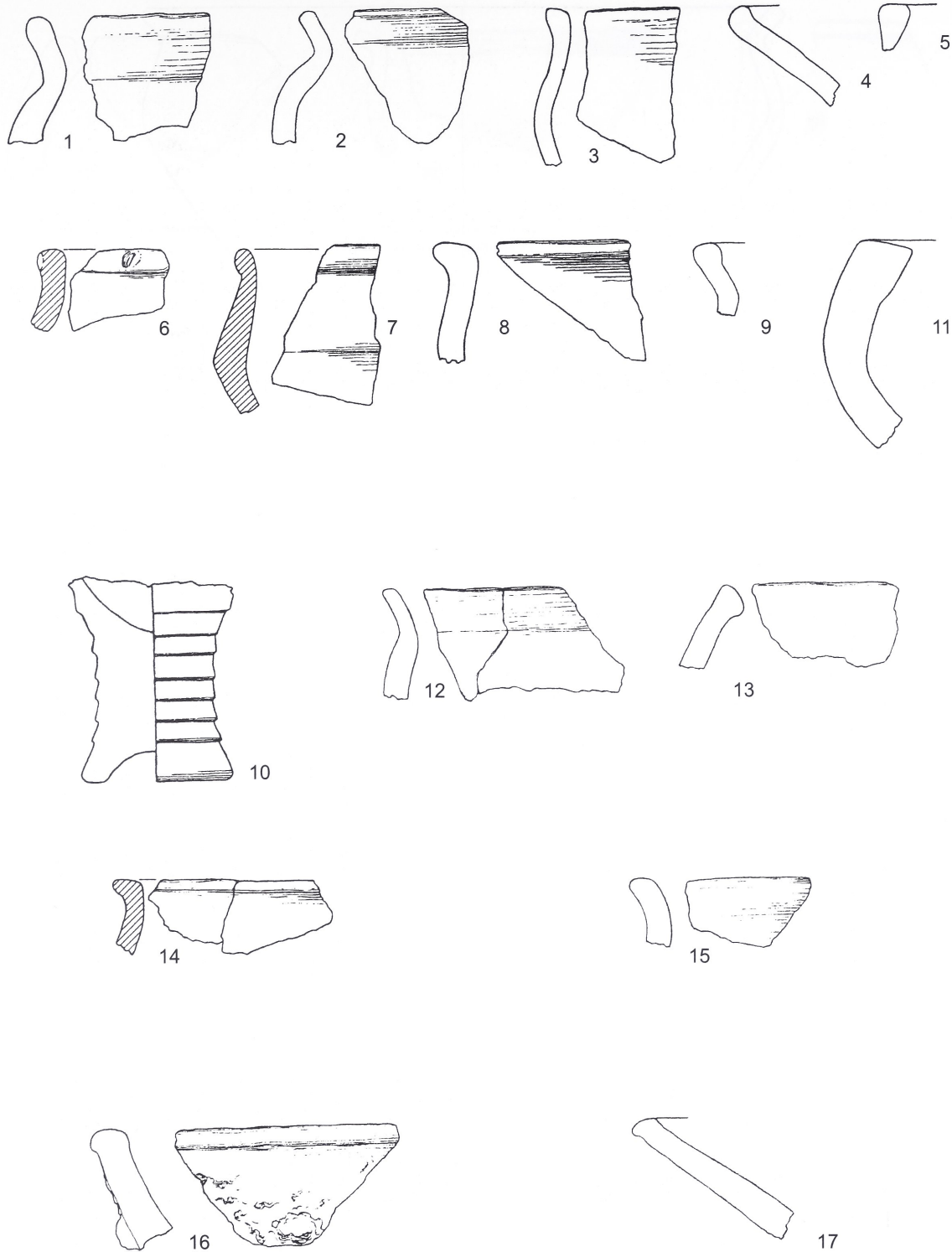

Paderborn, Königstraße 52 (Dkz. 4218,40), Gr. F. - Keramik, M. 1:2.

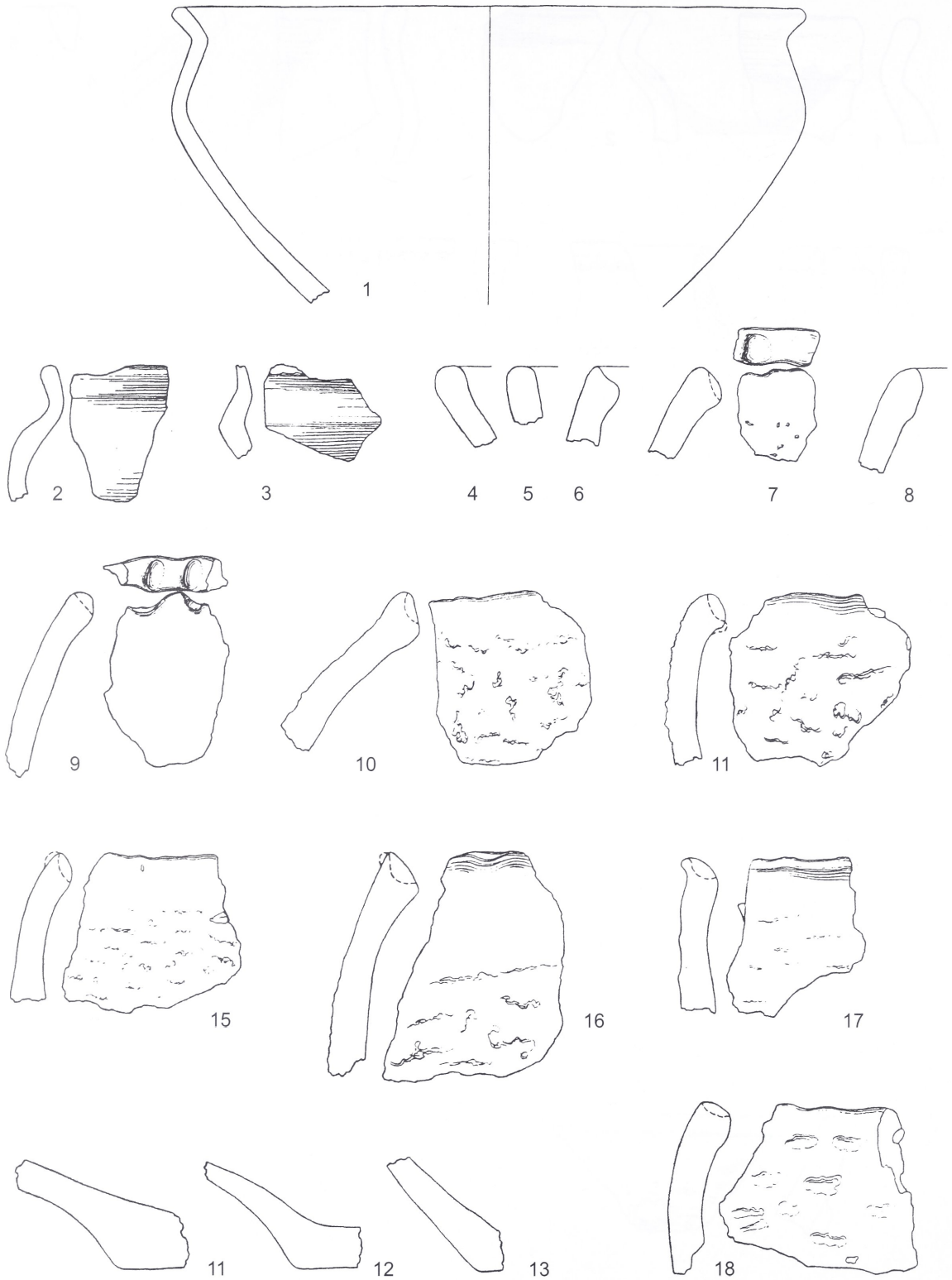

Paderborn, Königsstraße 52 (Dkz. 4218,40). Gr. L. - Keramik, M. 1:2.

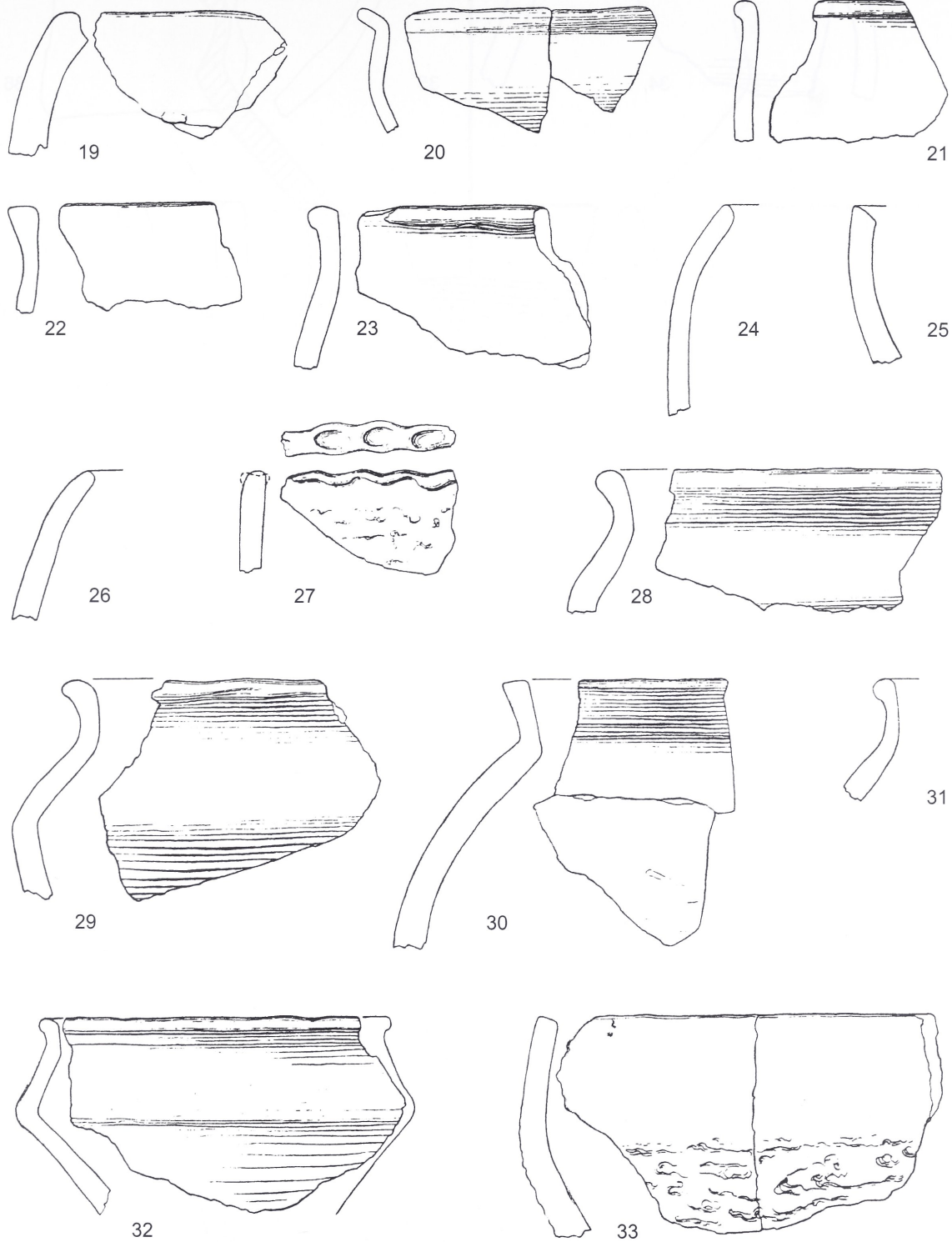

Paderborn, Königstraße 52 (Dkz. 4218,40). Gr. L. - Keramik M. 1:2.

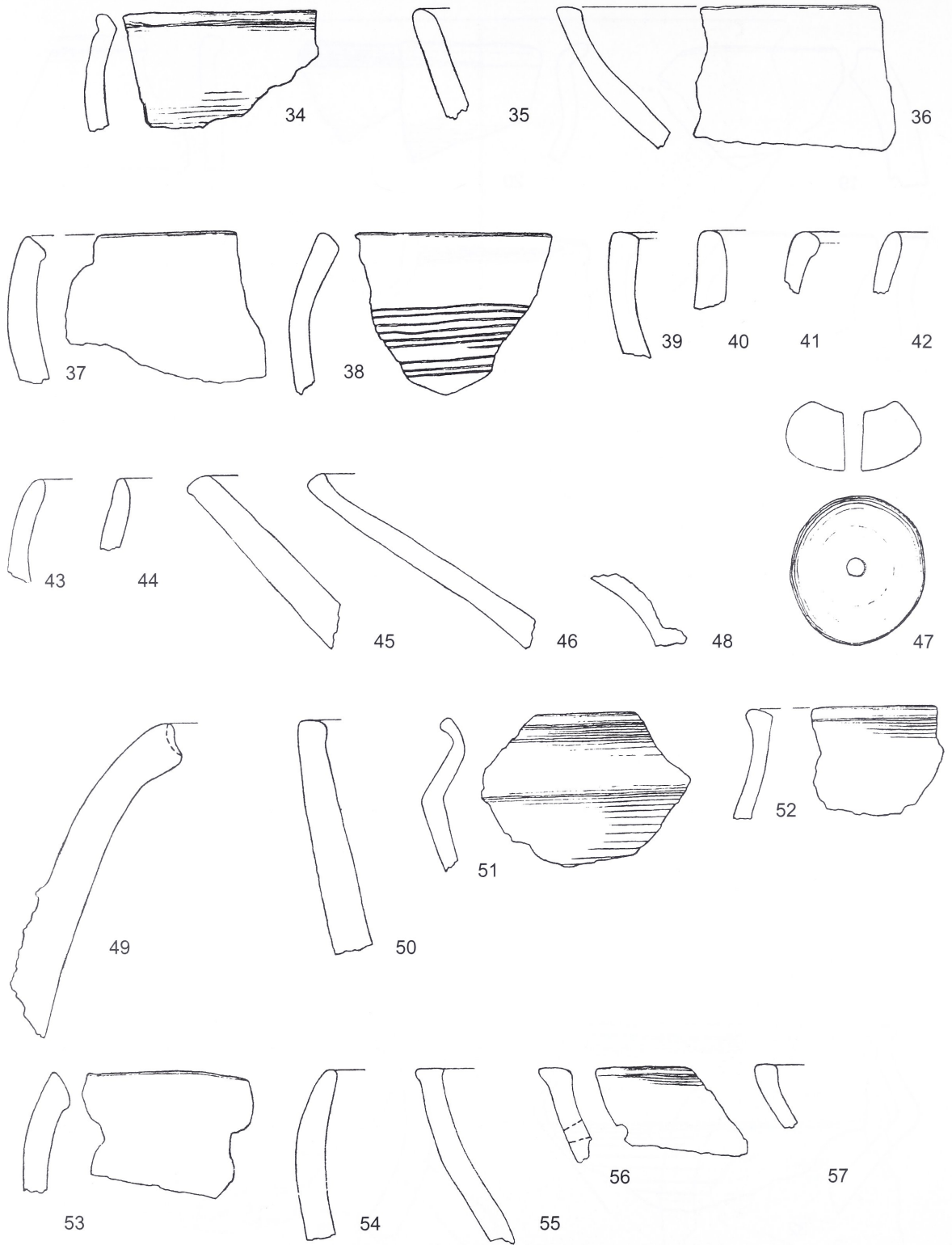

Paderborn, Königsstraße 52 (Dkz. 4218,40). Gr. L. - Keramik, M. 1:2.

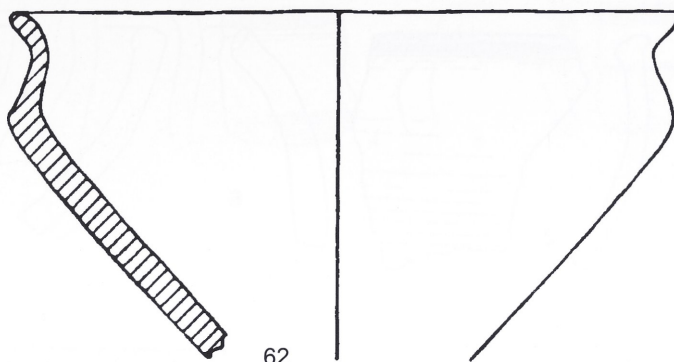

62

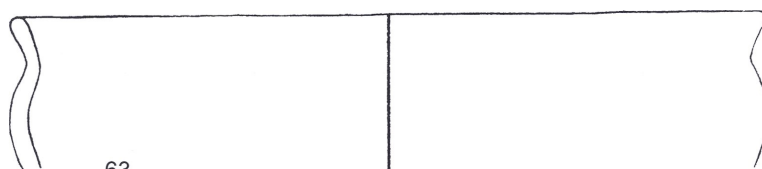

63

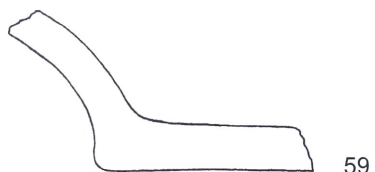

59

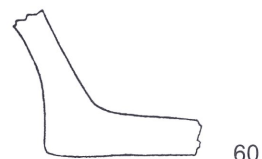

60

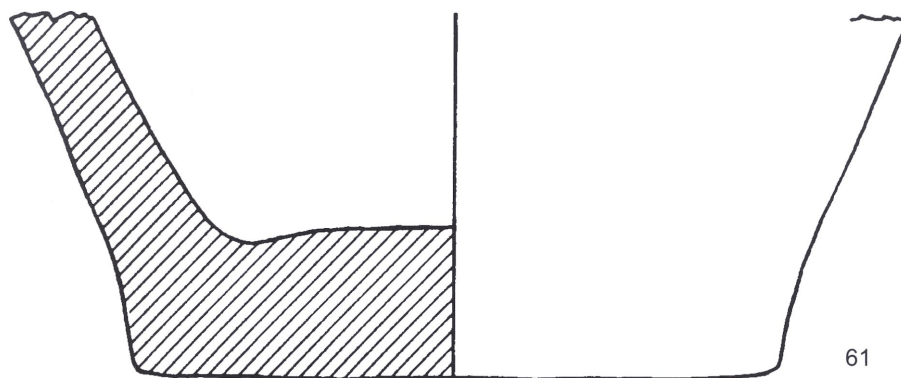

61

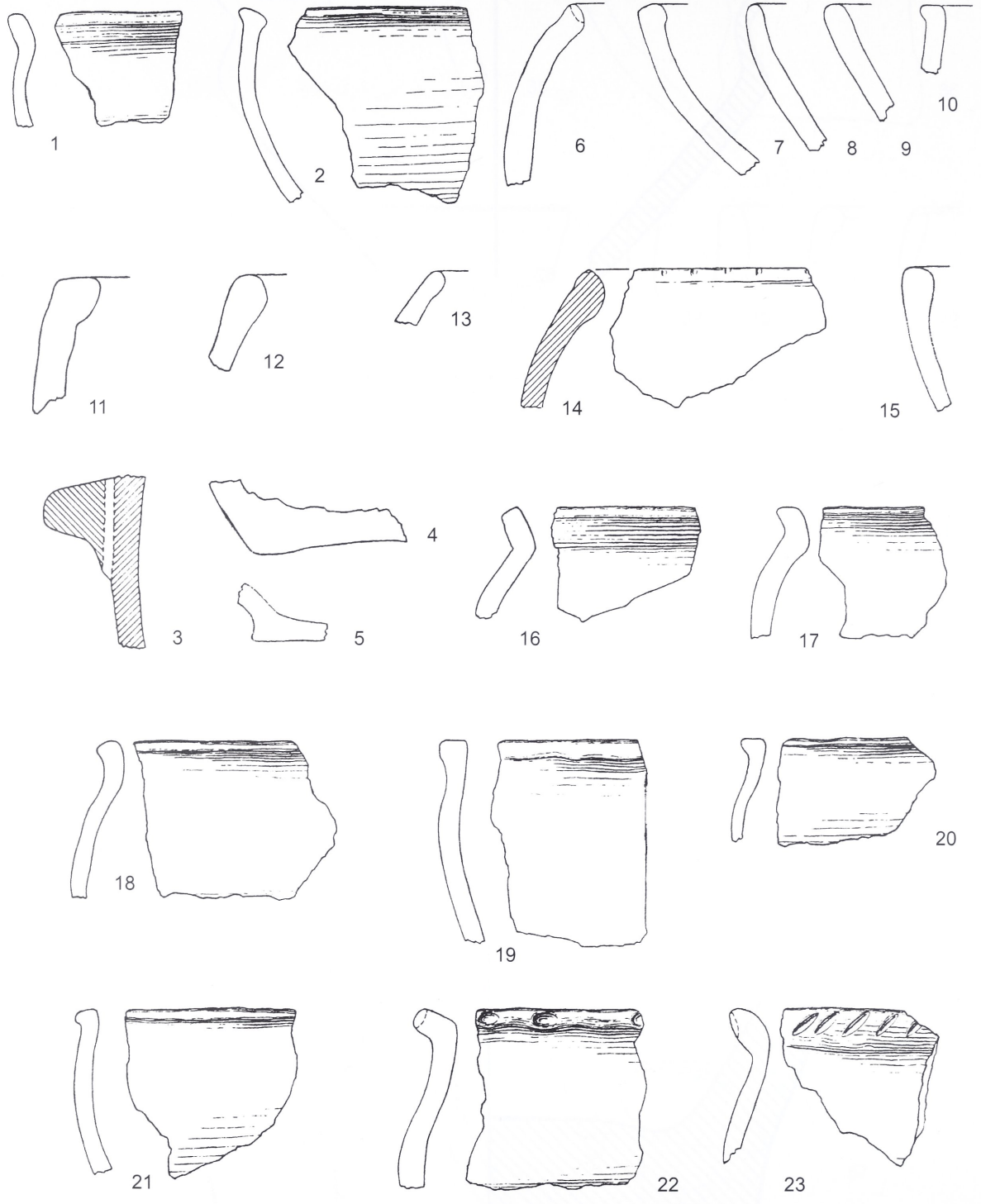

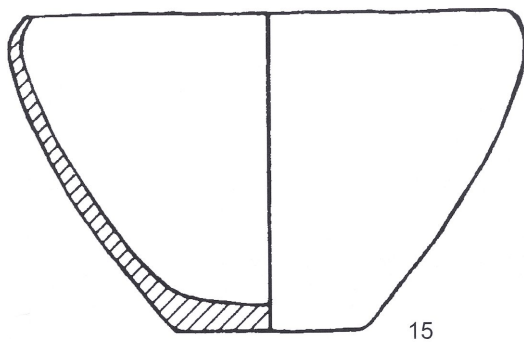
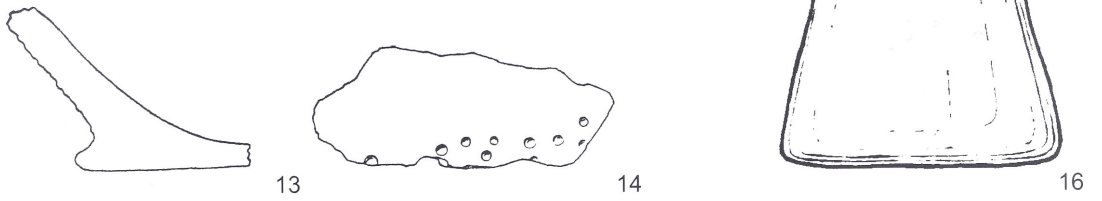
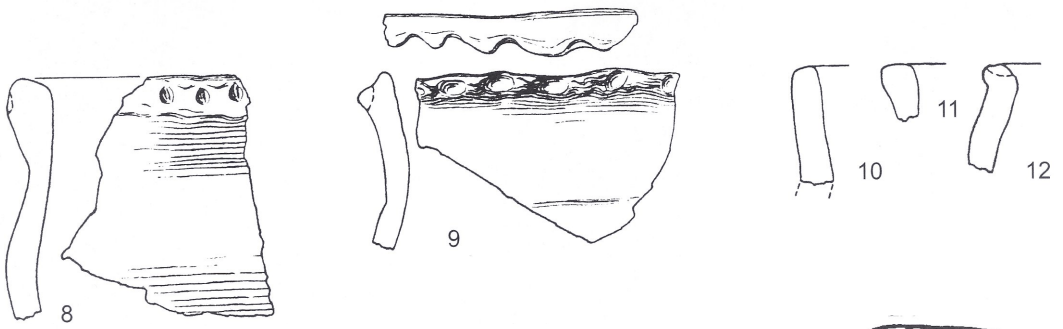
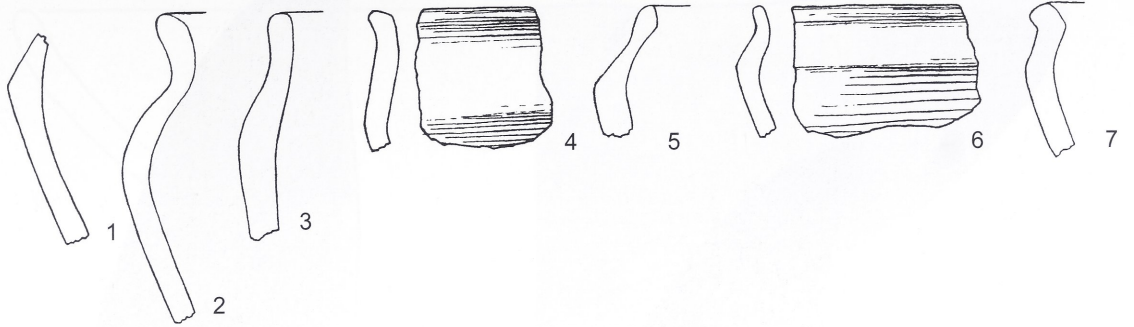

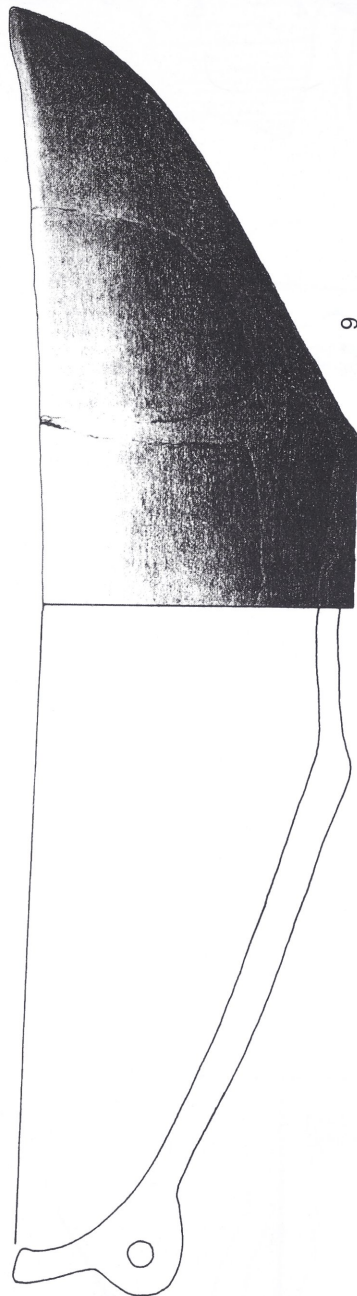
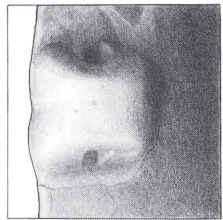

9

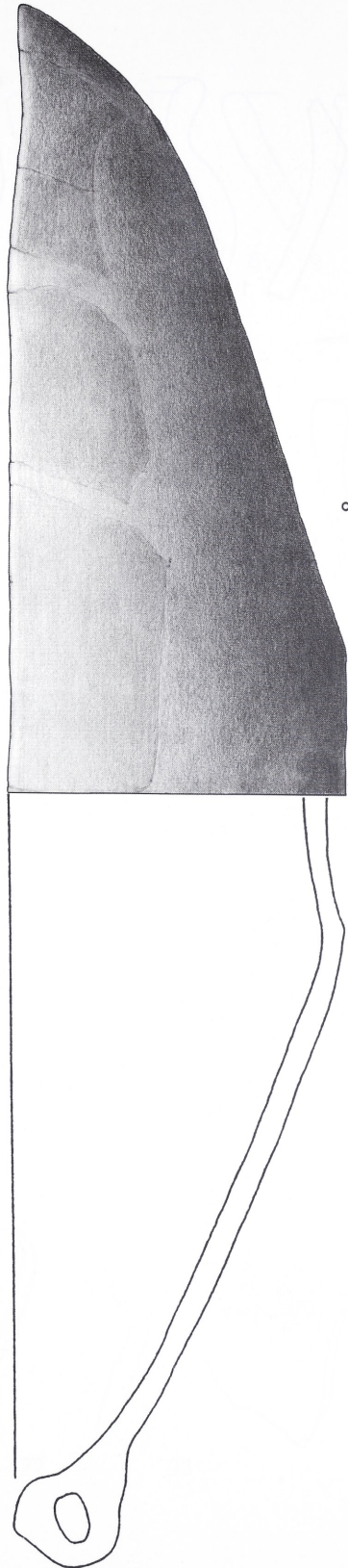

8

Lünen-Alstedde (Akz. 4310,500). - Keramik M. 1:2.

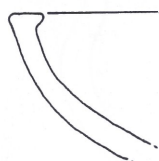
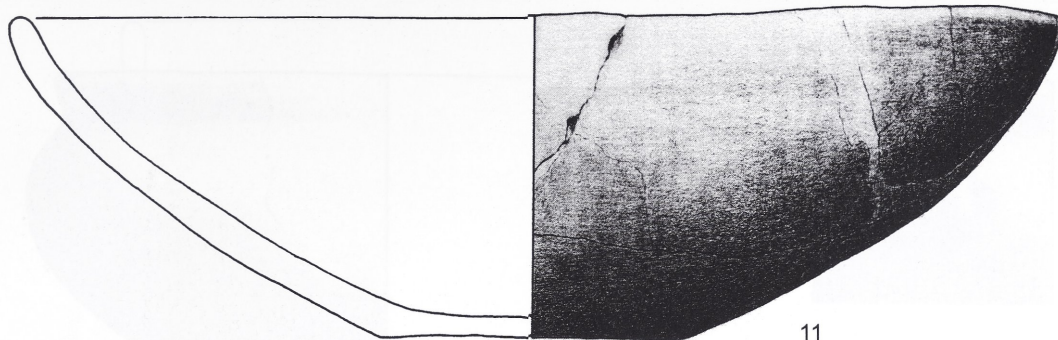

15

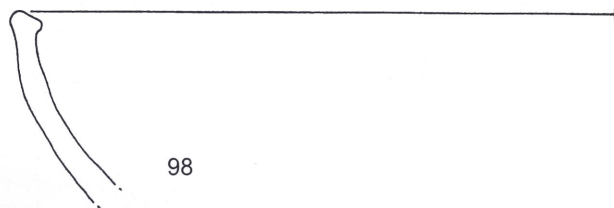

98

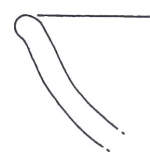

59



93

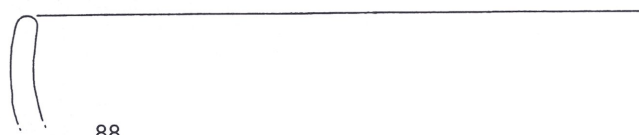

88

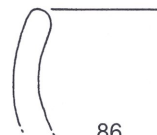

86

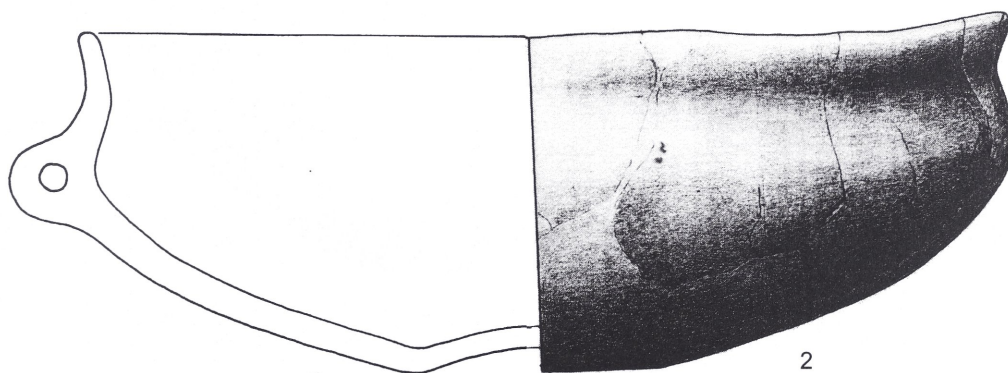

Lünen-Alstedde (Akz. 4310,500). - Keramik M. 1:2.

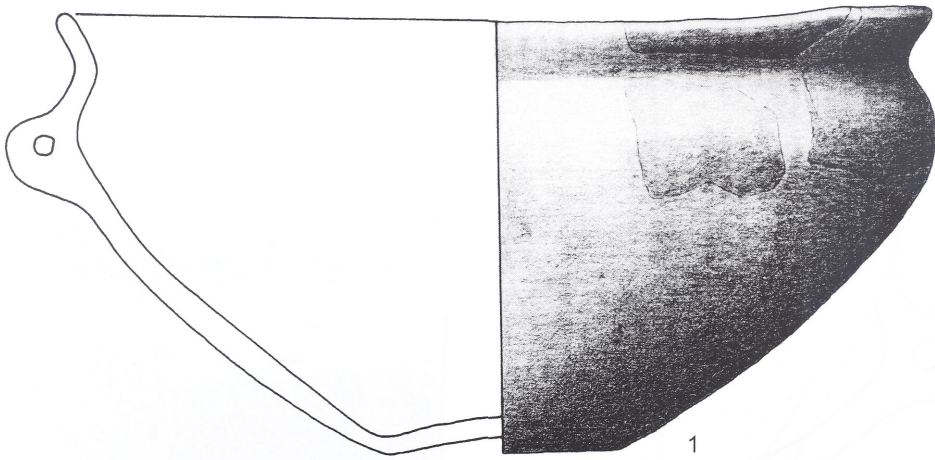
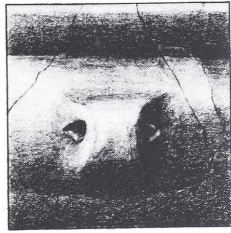
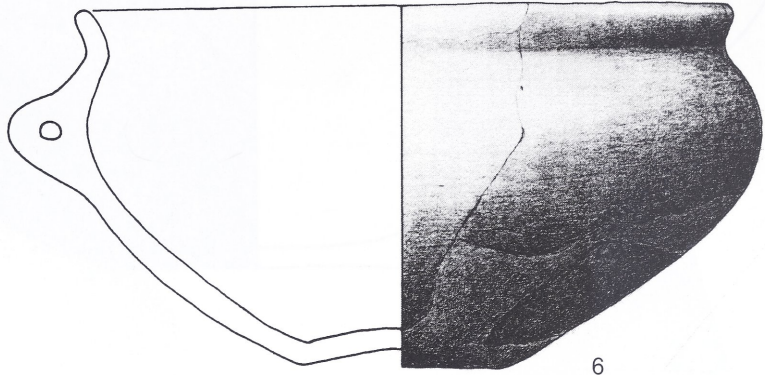
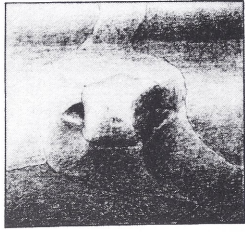

Lünen-Alstedde (Akz. 4310,500). - Keramik M. 1:2.

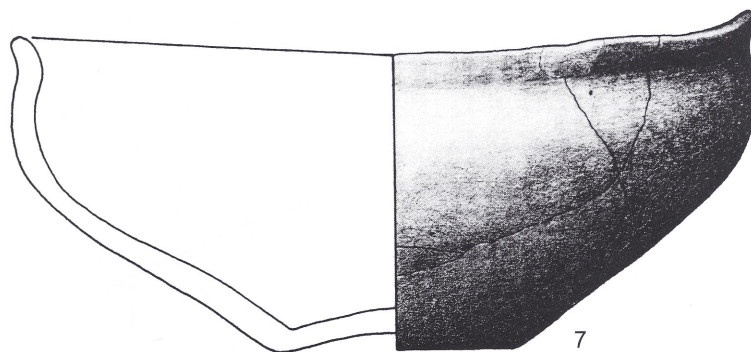
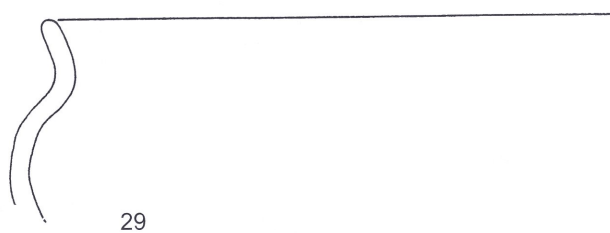
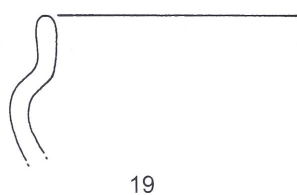
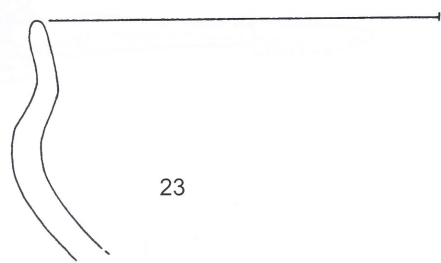
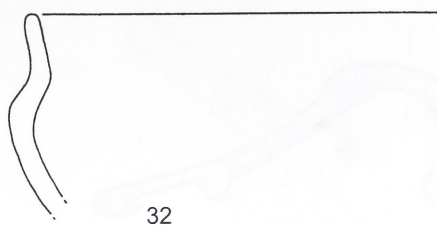
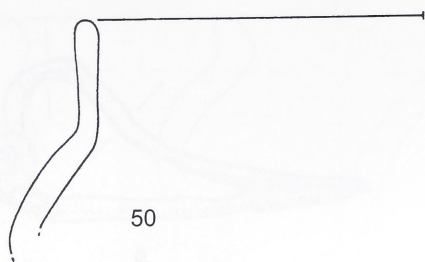

Lünen-Alstedde (Akz. 4310,500). - Keramik M. 1:2.

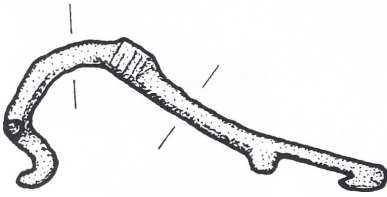

1

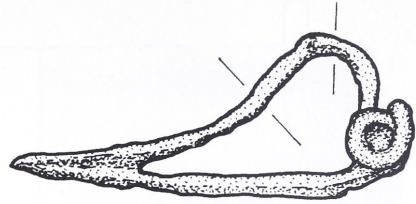

2

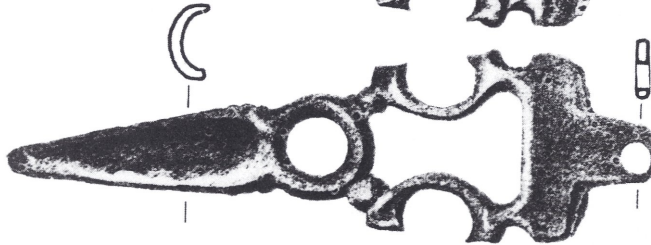
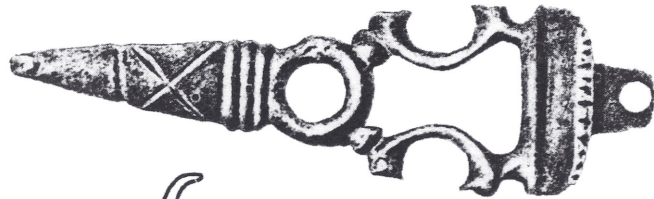
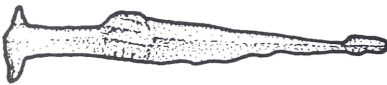

3



4

1. und 2. Paderborn-Am Hoppenhof (Dkz. 4218,31); 3. Lünen-Beckinghausen (Akz. 4311,93);
4. Hamm-Altlünerweg (Akz. 4312,500). Eisen, Bronze M. 1:1.

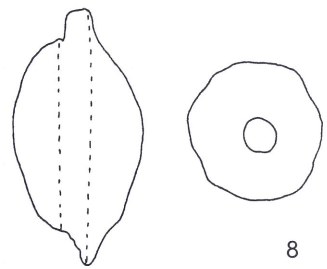
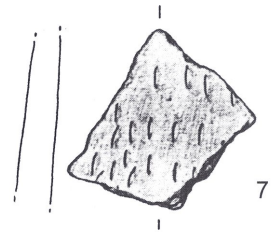
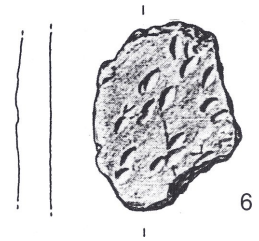
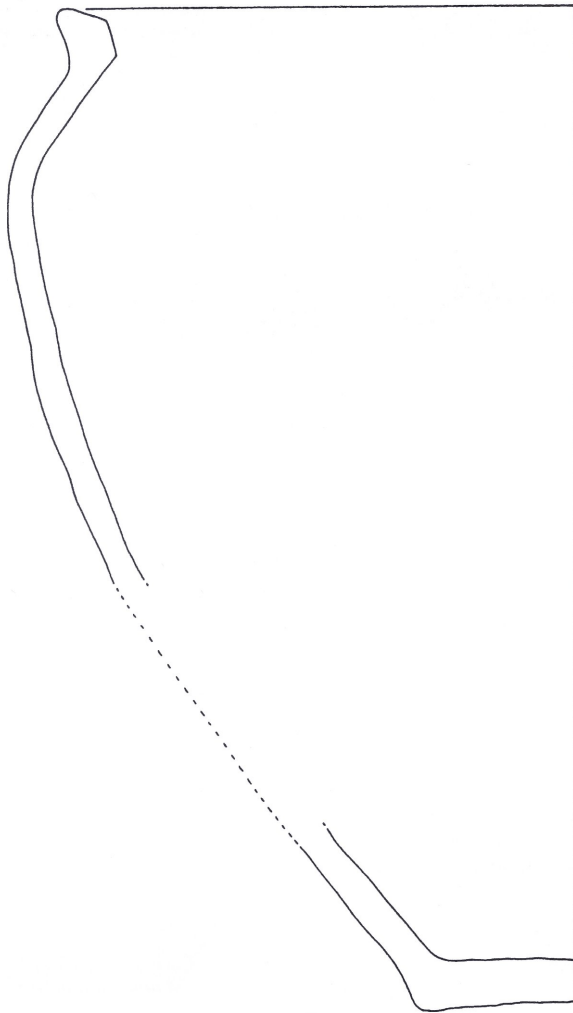
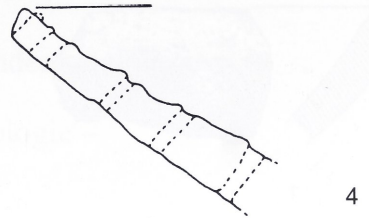
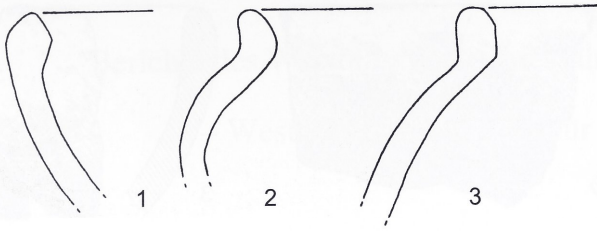

Bergkamen-Rünthe, Friedhof (Akz. 4311,503). - Keramik M. 1:2.

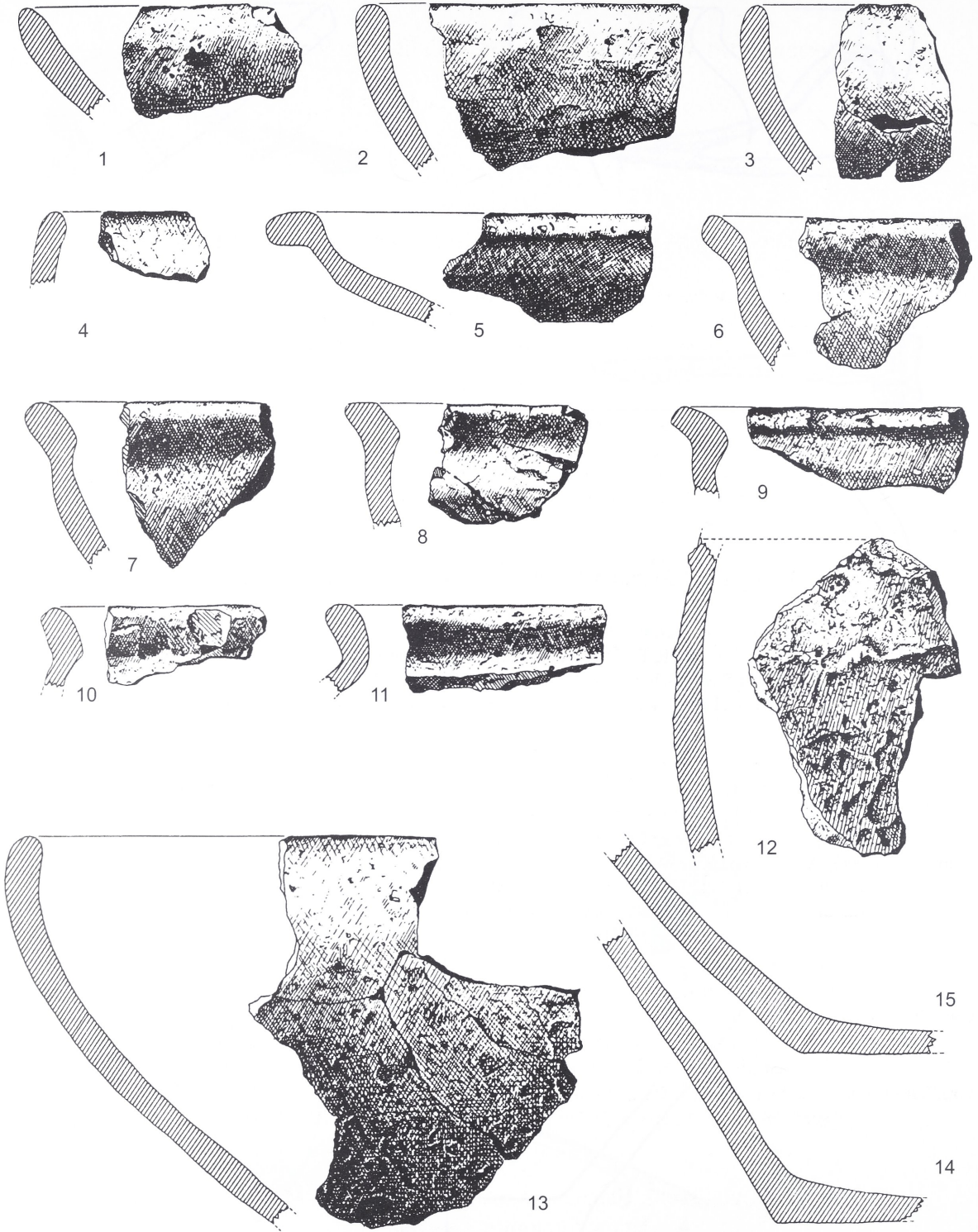

Hamm-Osterflörich (Akz. 4413,103). - Keramik M. 1:2.