

Tafeln

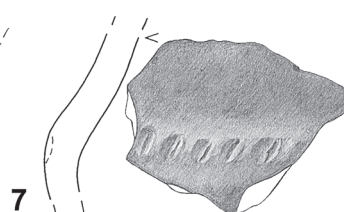

Katalognummer 2: 1 und 2: M 1:3; 3-7: M 1:2.

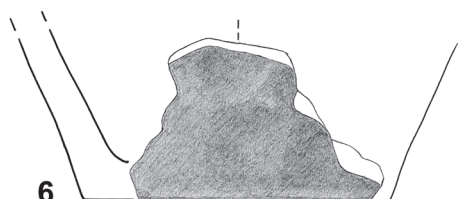

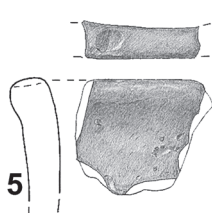
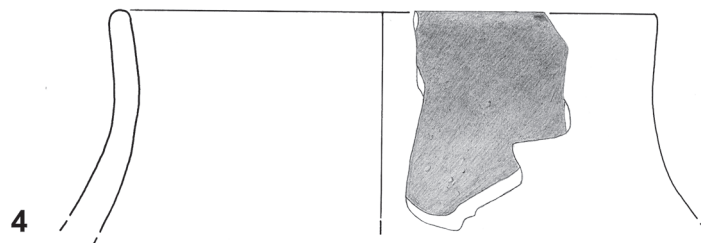
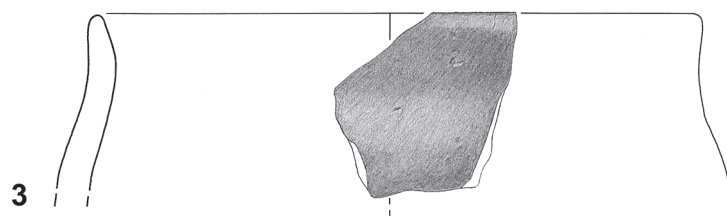
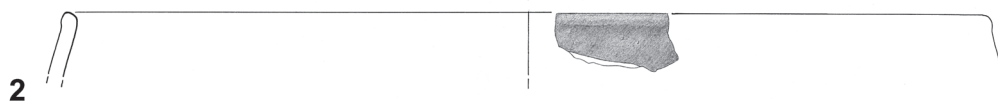
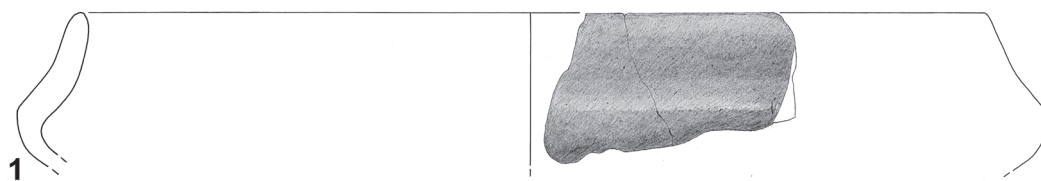
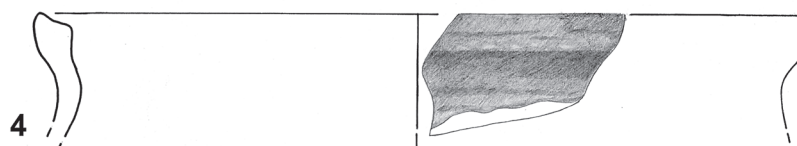
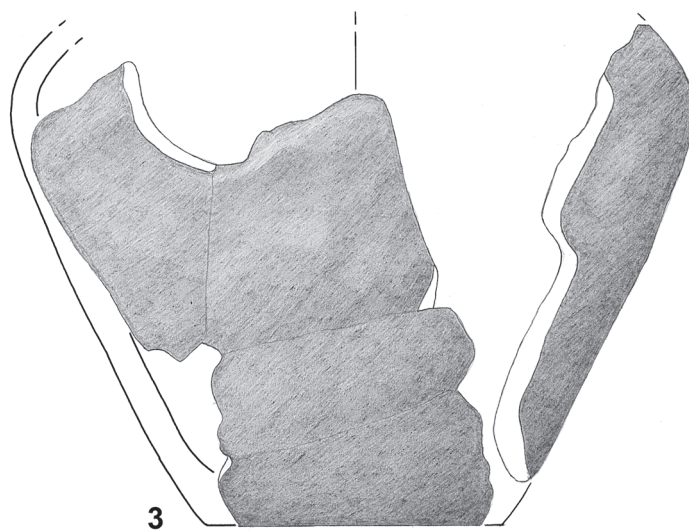
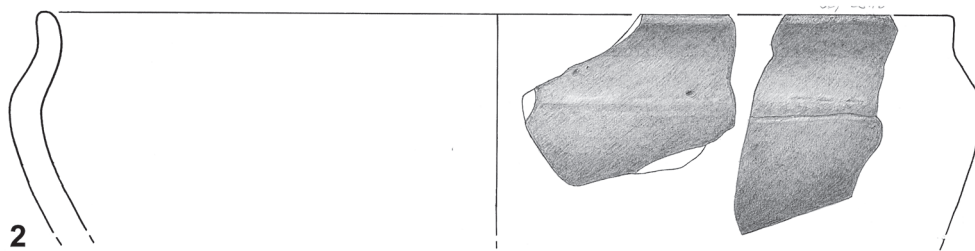
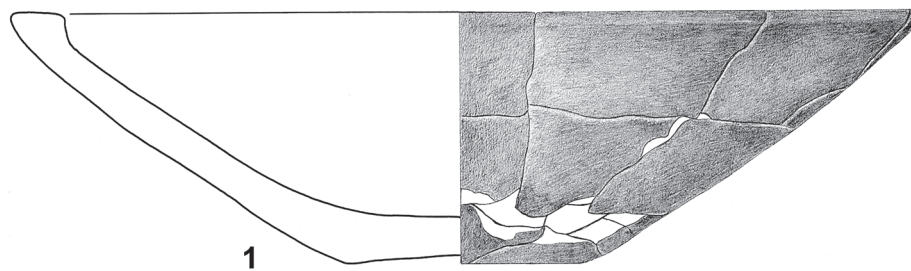
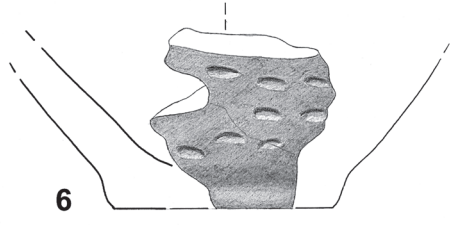
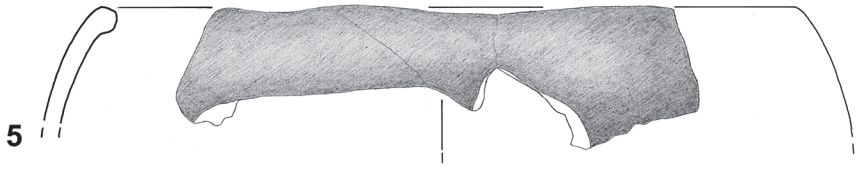
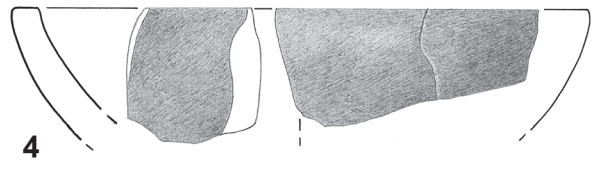
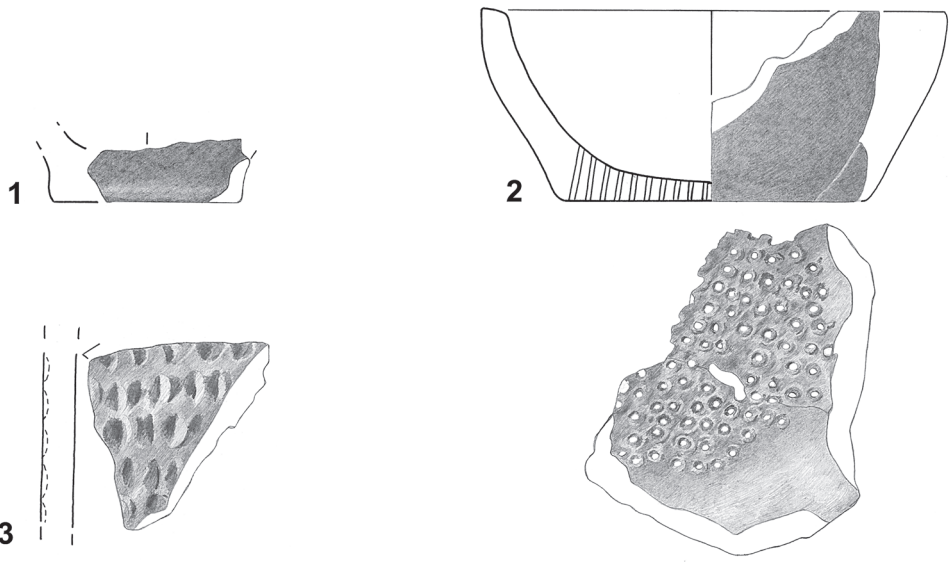

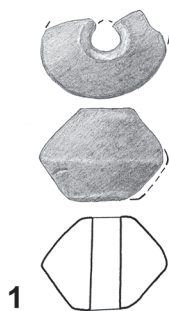

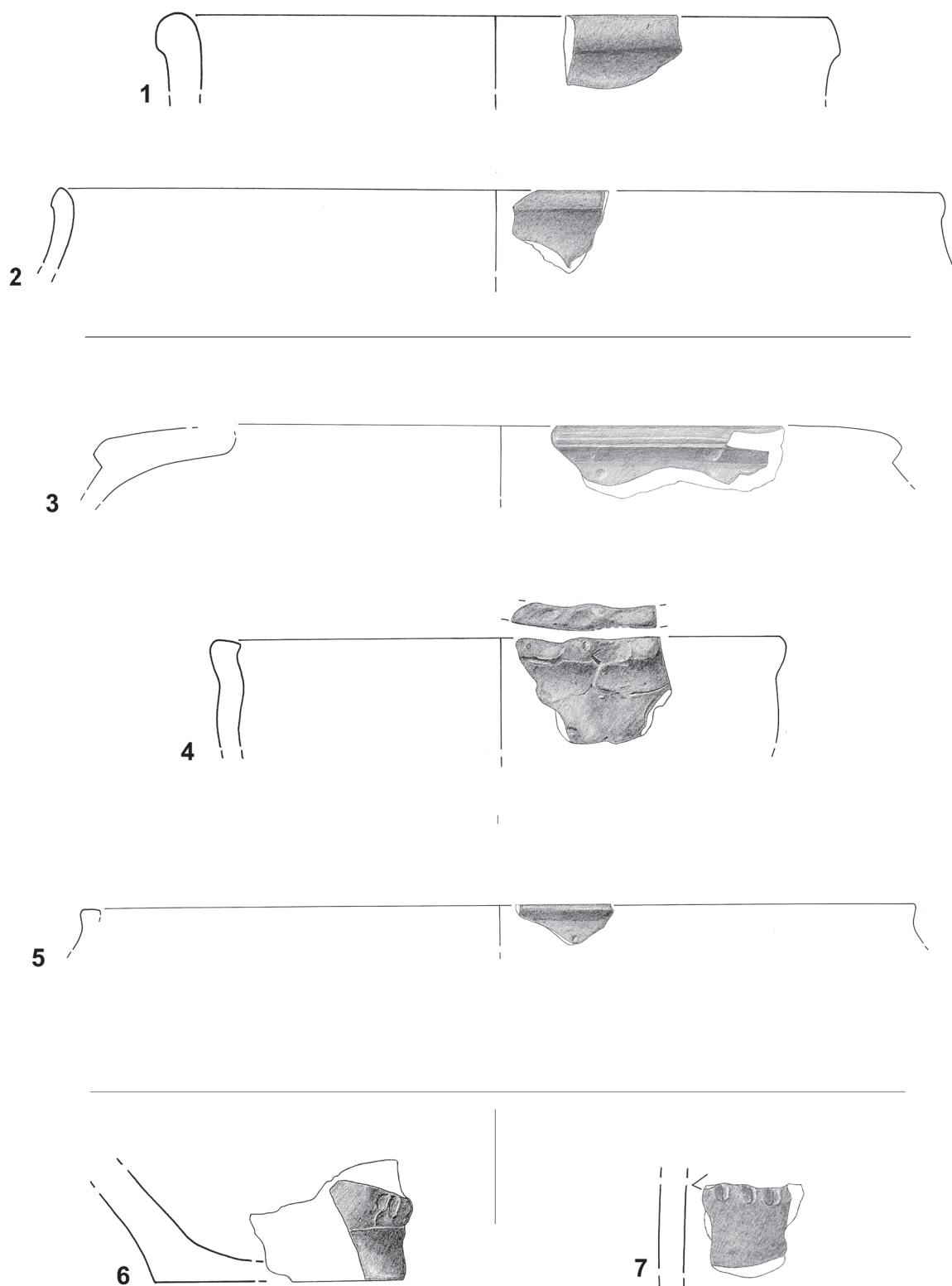

1 und 2: Katalognummer 25; 3–5: Katalognummer 71; 6: Katalognummer 78; 7: Katalognummer 108. –
3 und 5: M 1:3; 1, 2, 4, 6, 7: M 1:2.

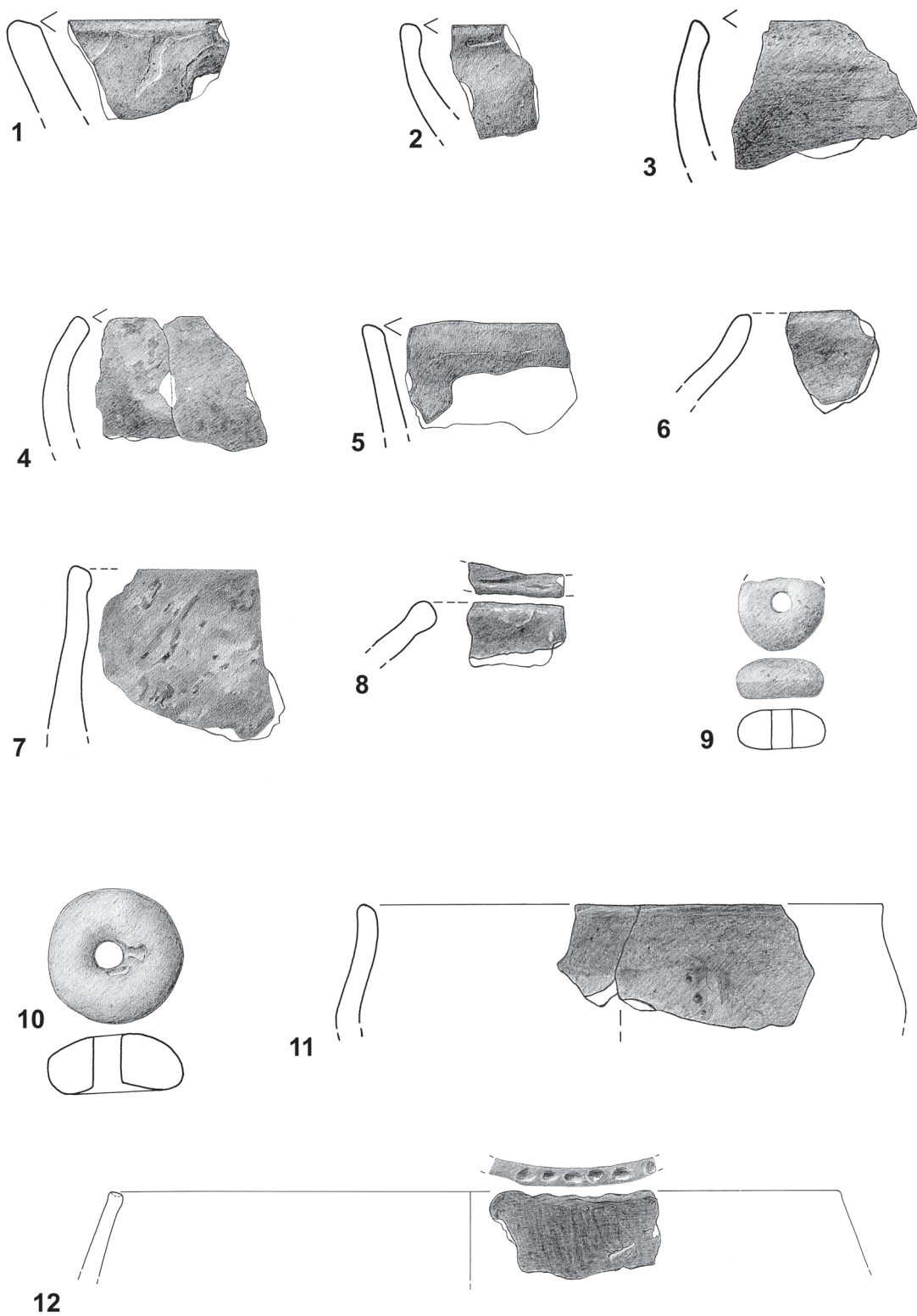

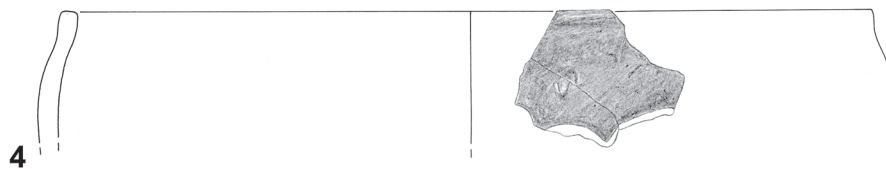
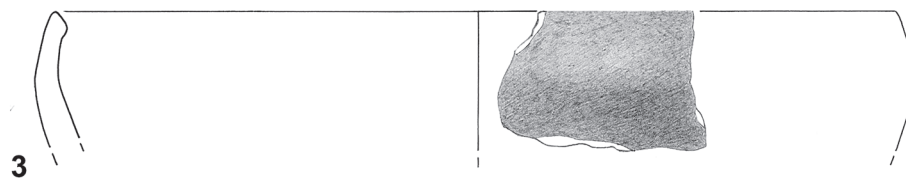
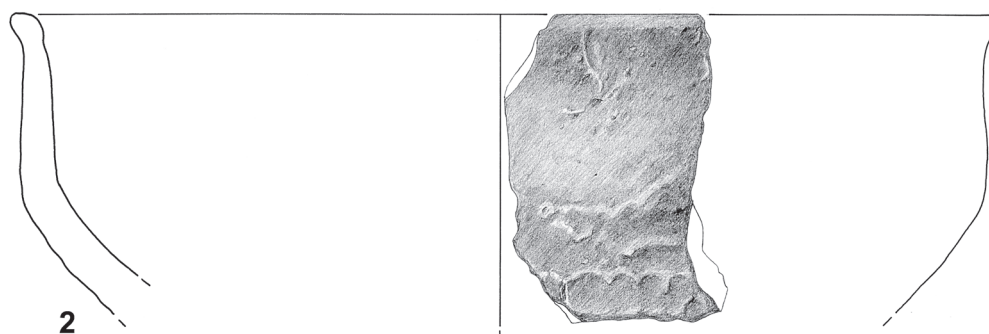
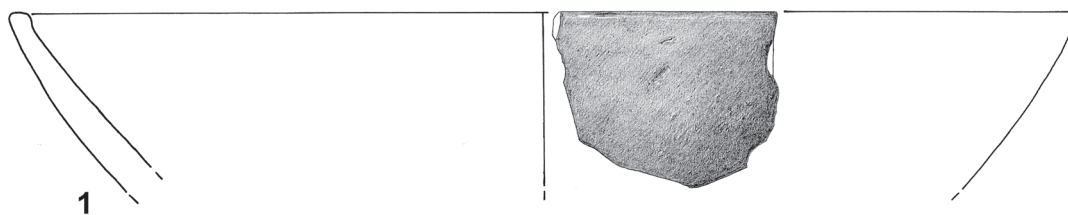

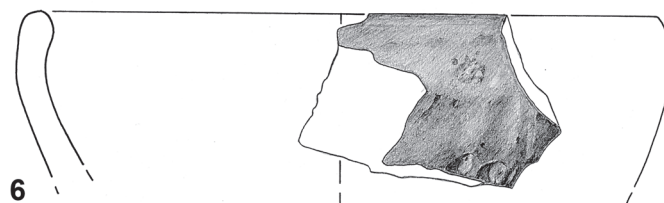
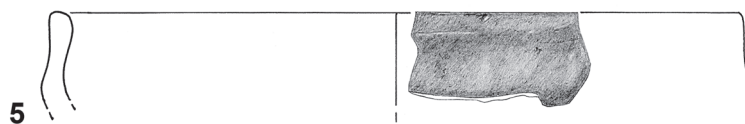
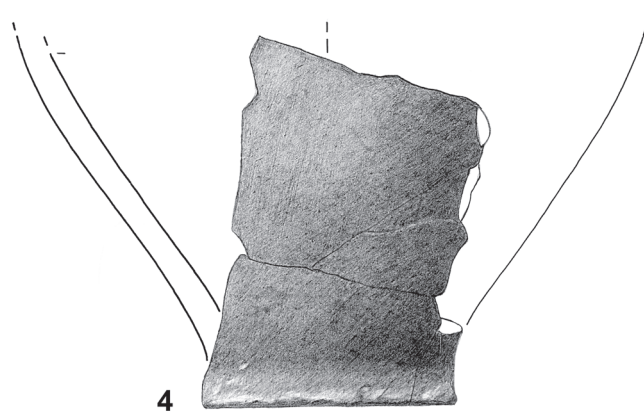
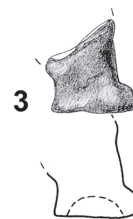
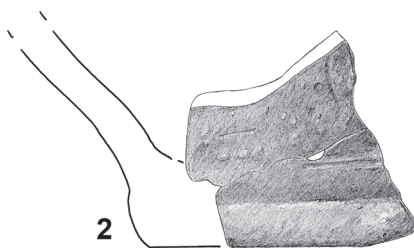
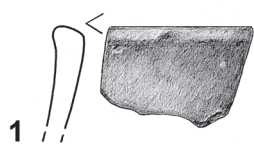

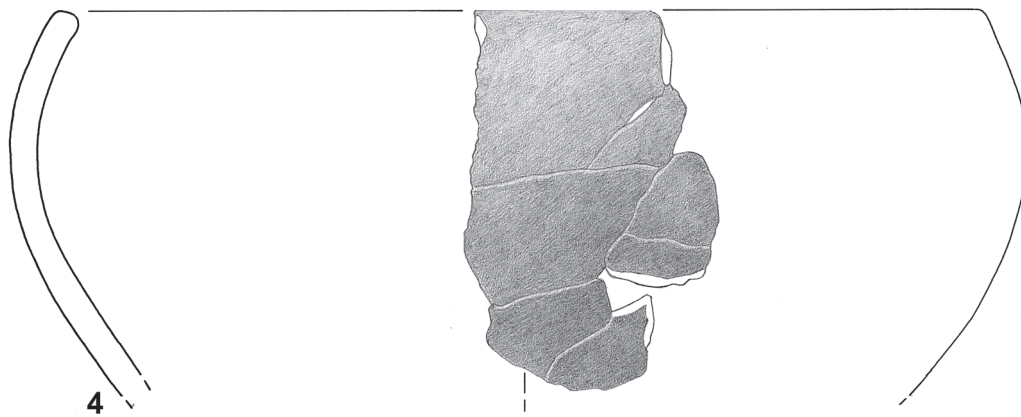
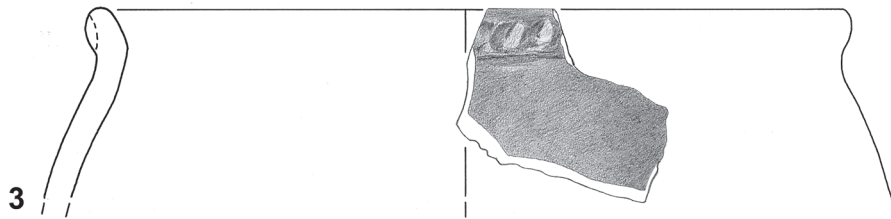
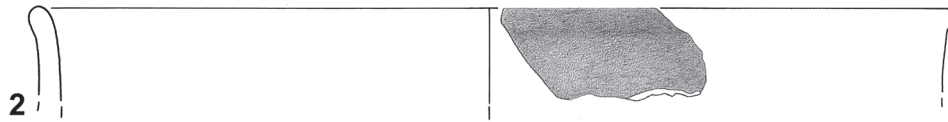

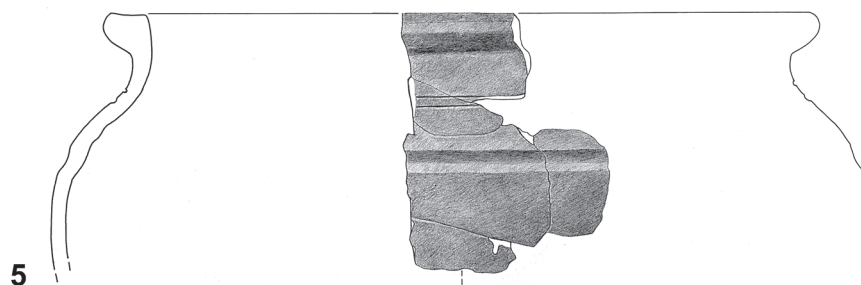
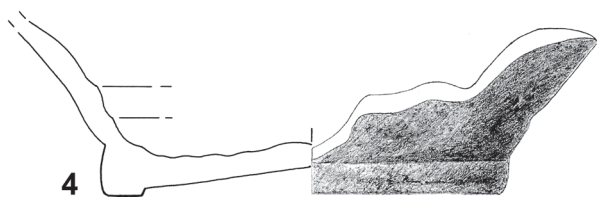
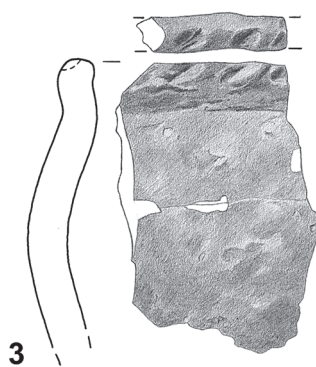
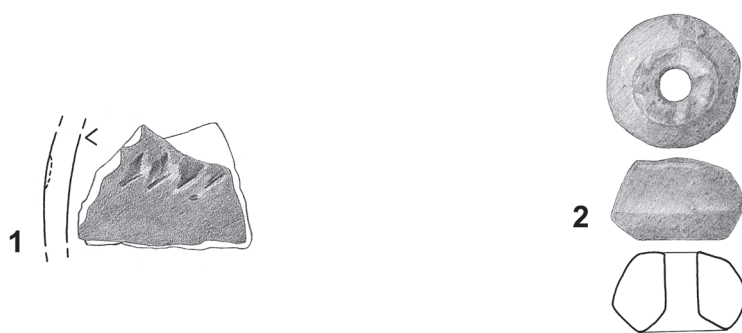

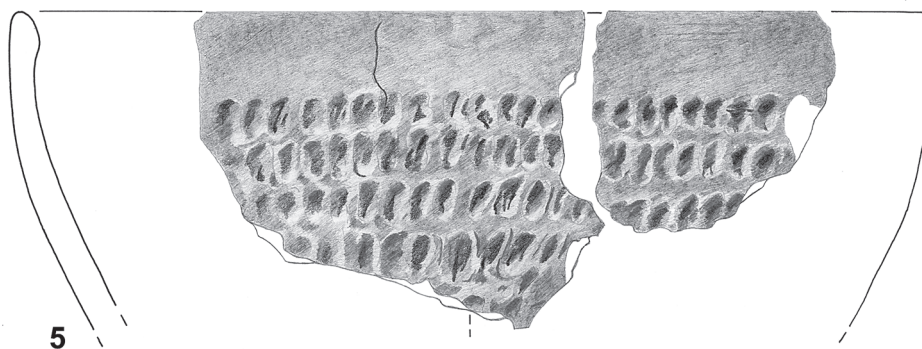
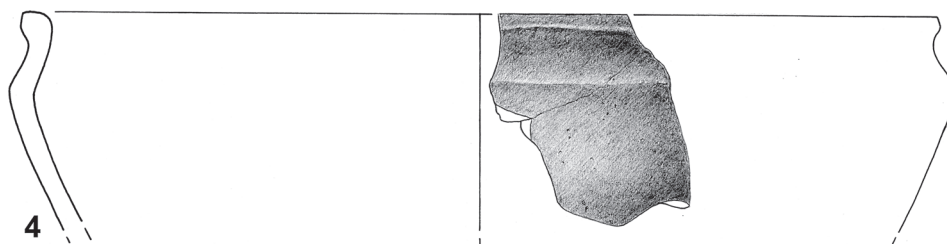
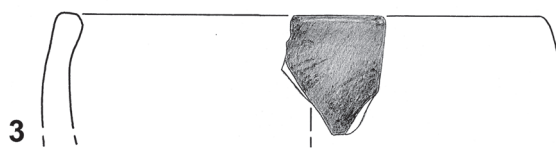
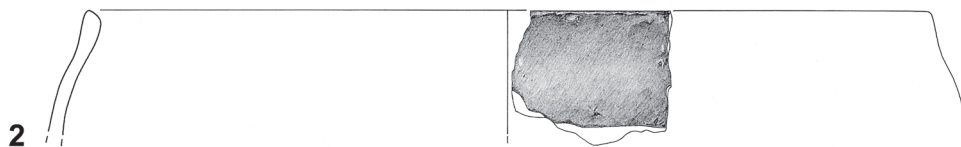
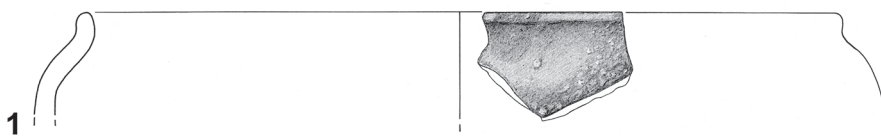

1–4: Katalognummer 128; 5: Katalognummer 132. – 1 und 2: M 1:3; 3–5: M 1:2.

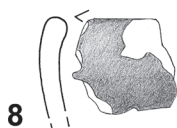
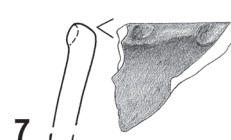
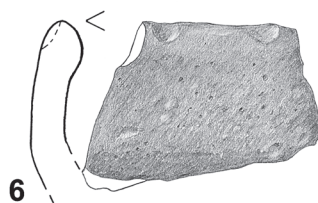
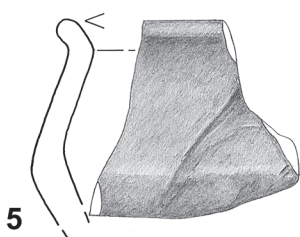
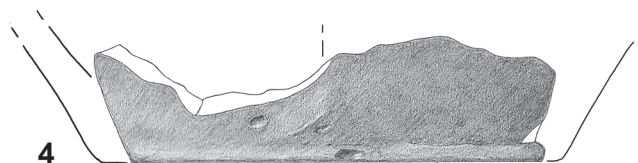
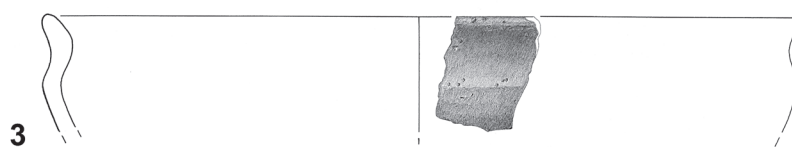
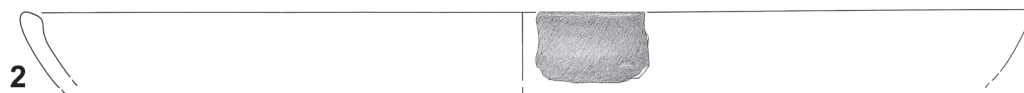
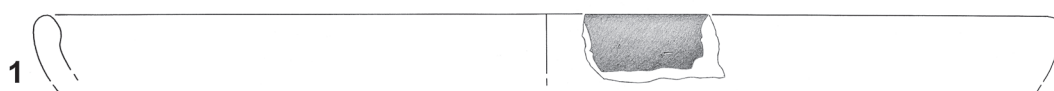

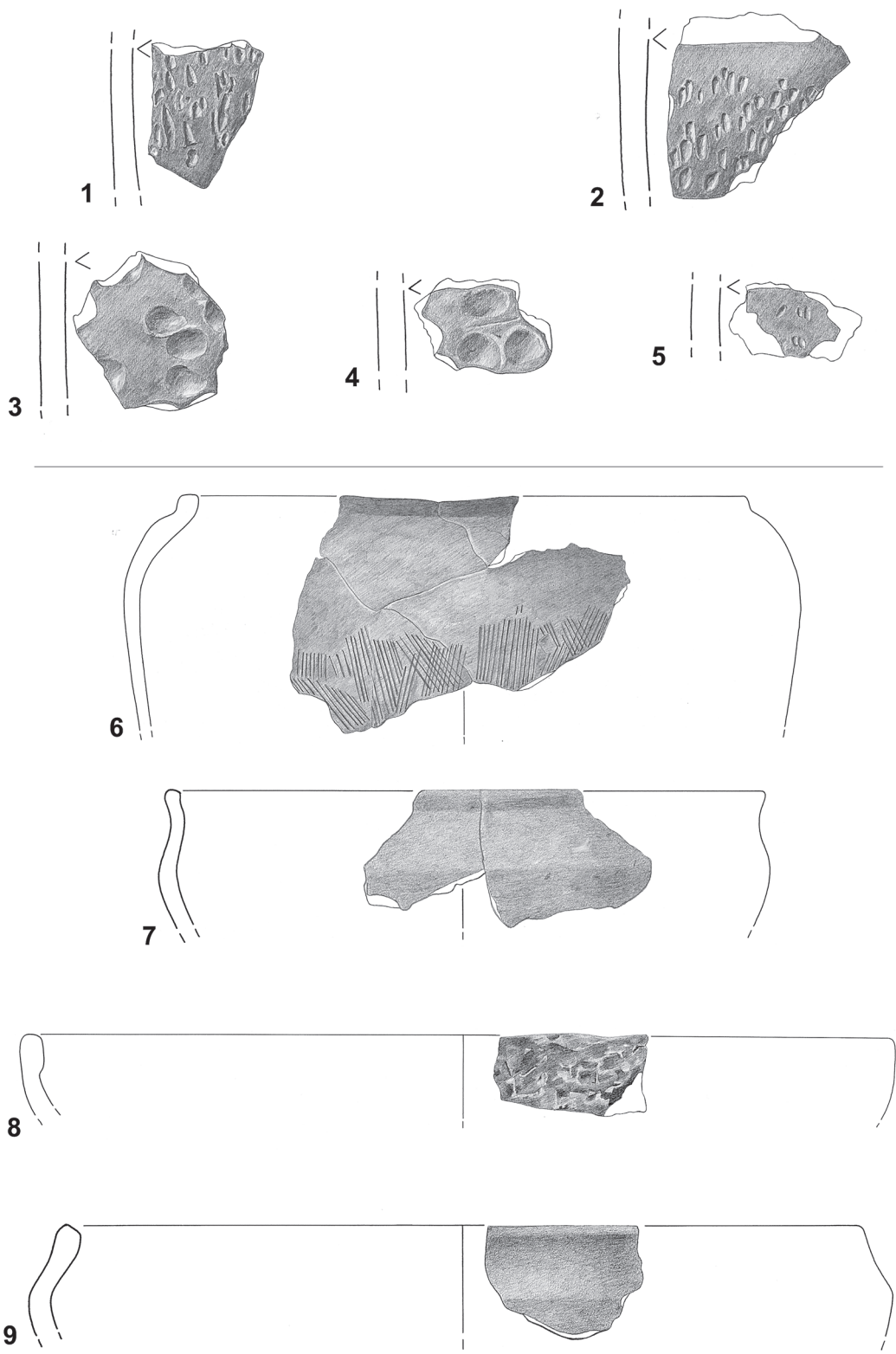

1-5: Katalognummer 146; 6-9: Katalognummer 152. – 8: M 1:3; alle anderen: M 1:2.

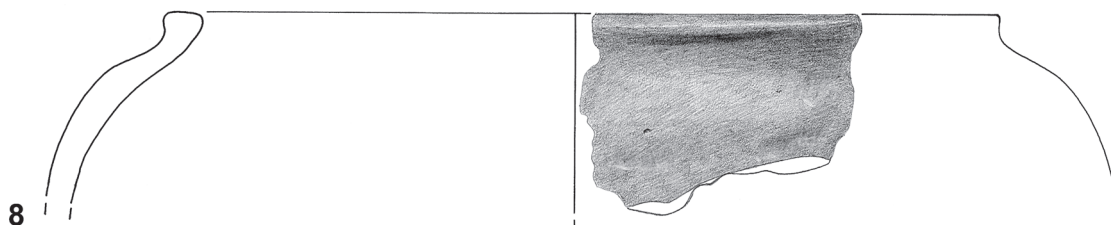
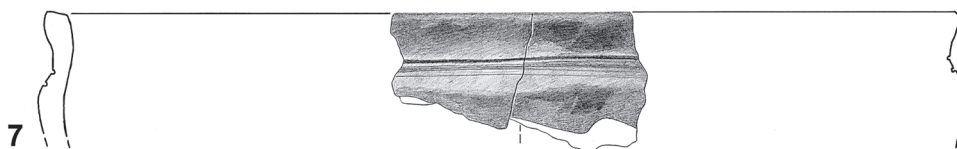
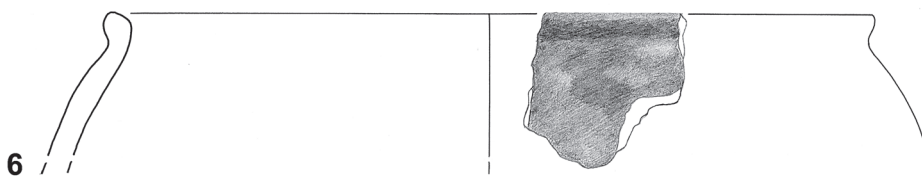
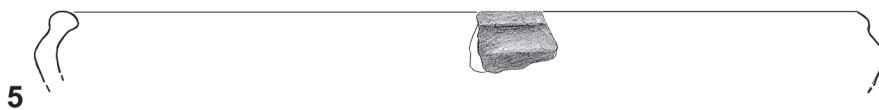
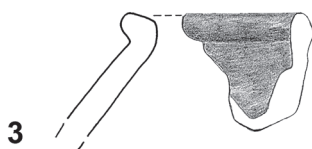
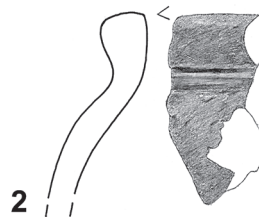
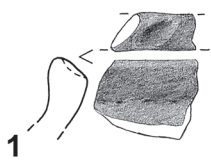

Katalognummer 152: 1–4, 7, 8: M 1:2; 5 und 6 M 1:3.

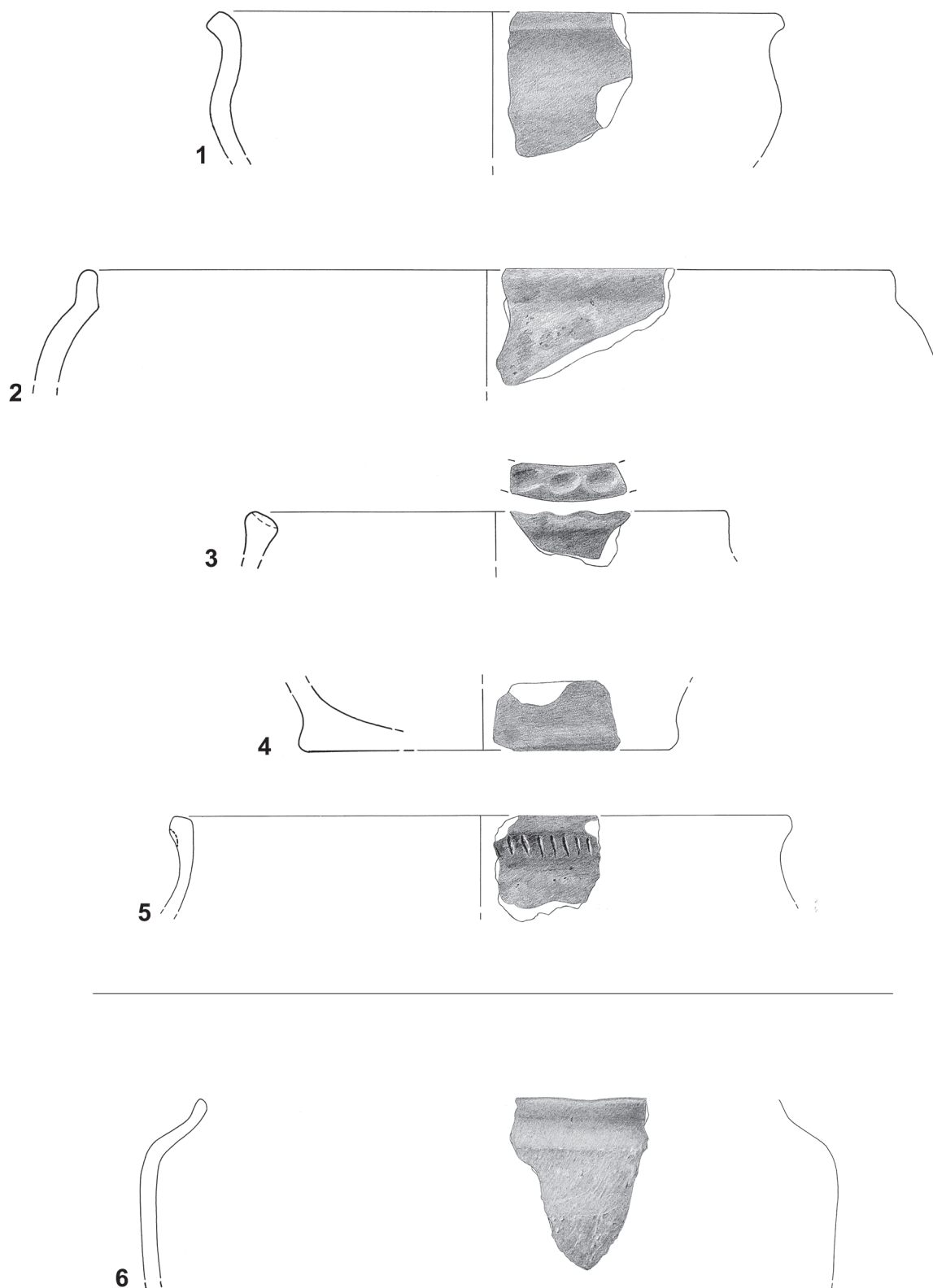

1–5: Katalognummer 152; 6: Katalognummer 153. – 1–4: M 1:2; 5 und 6: M 1:3.

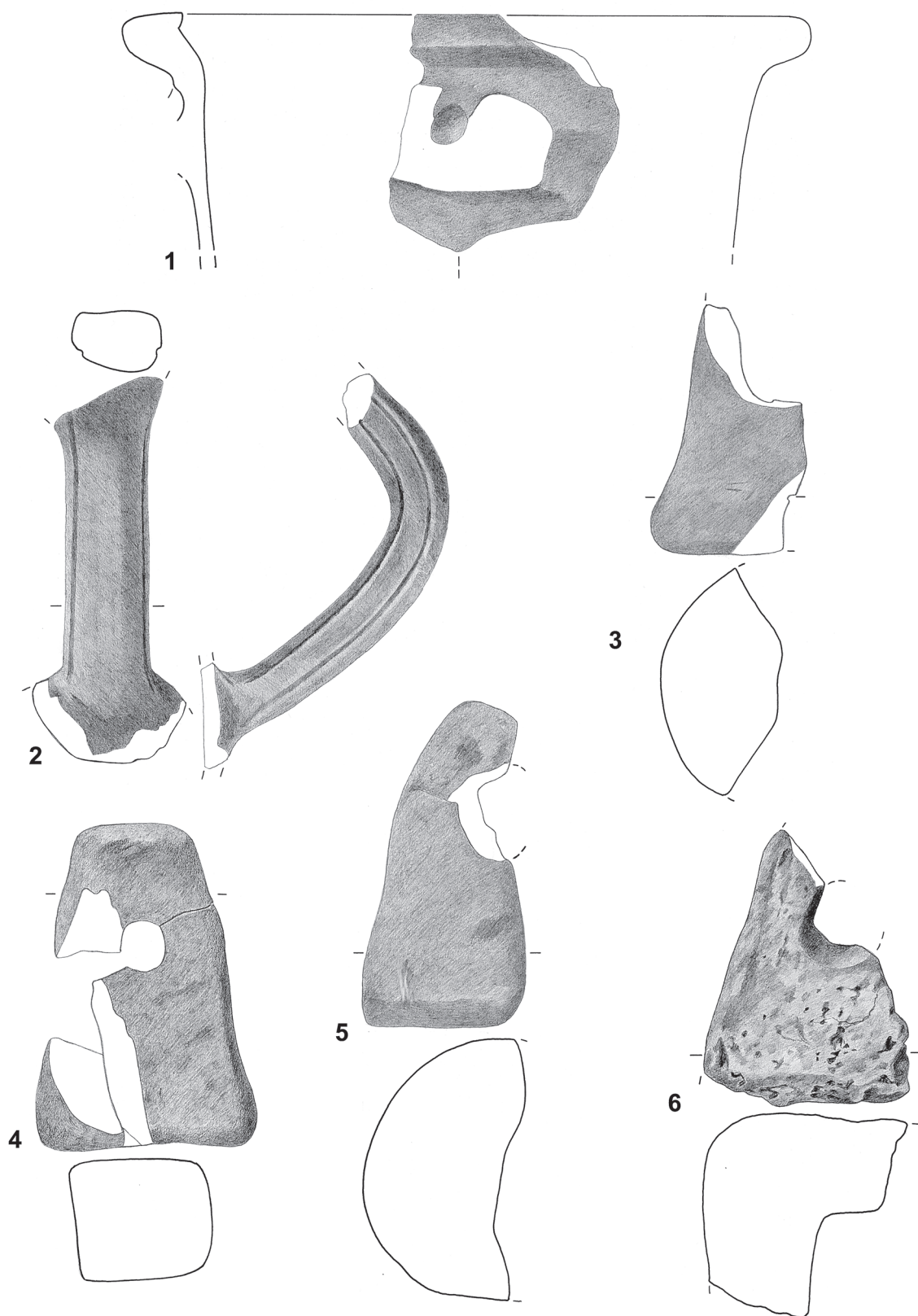

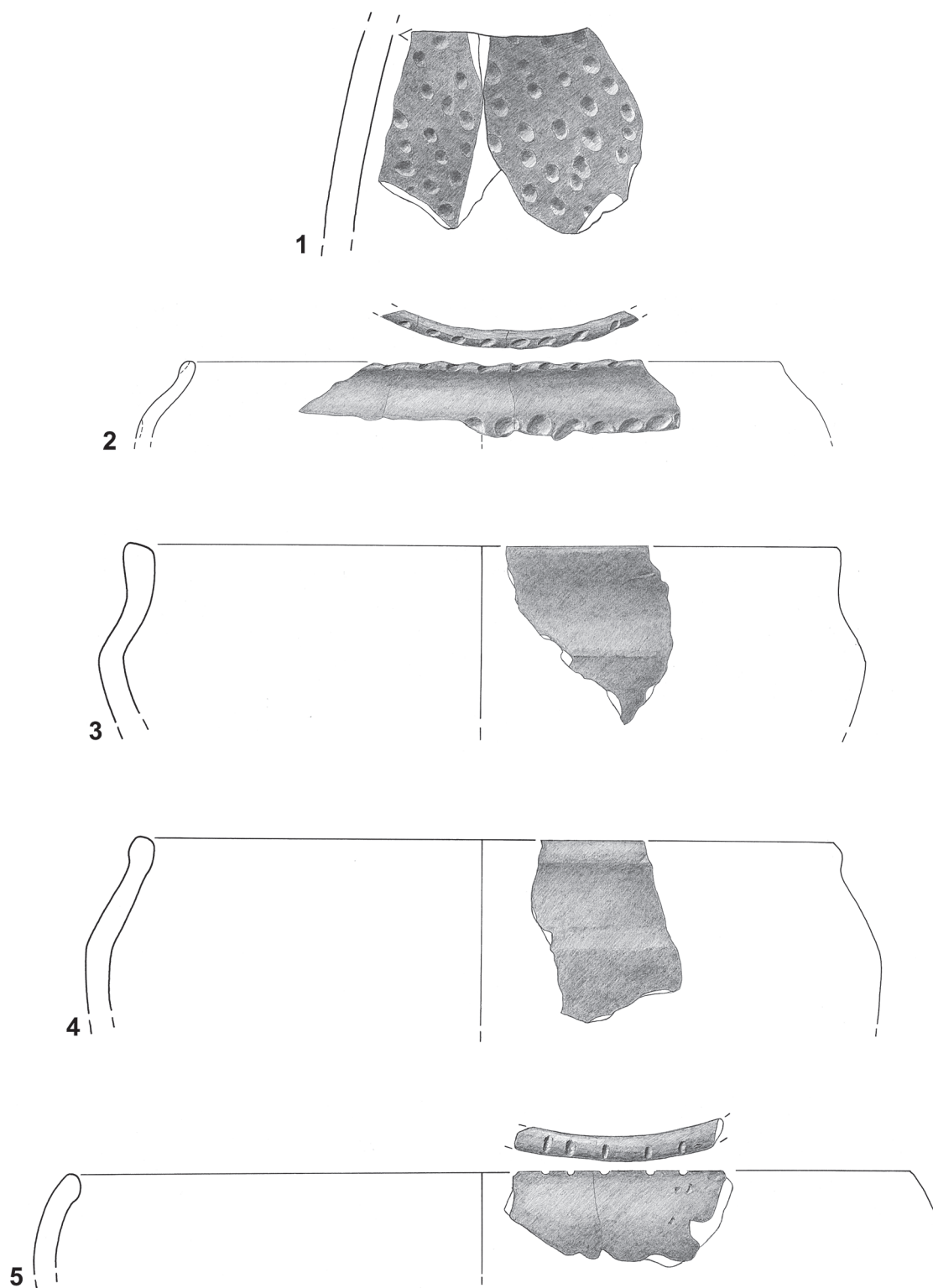

Katalognummer 153: 2: M 1:3; alle anderen: M 1:2.

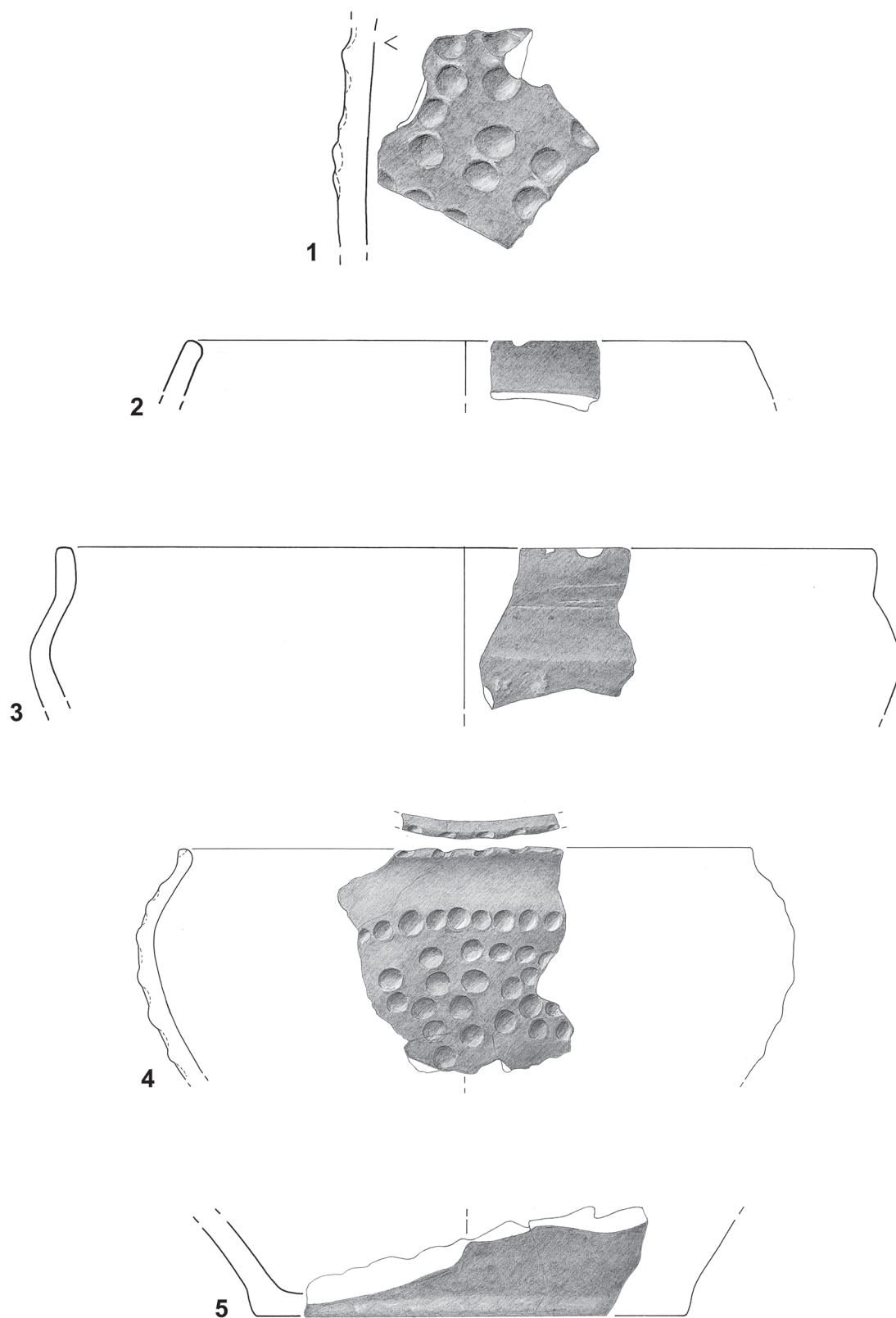

Katalognummer 153: 4: M 1:3; alle anderen: M 1:2.

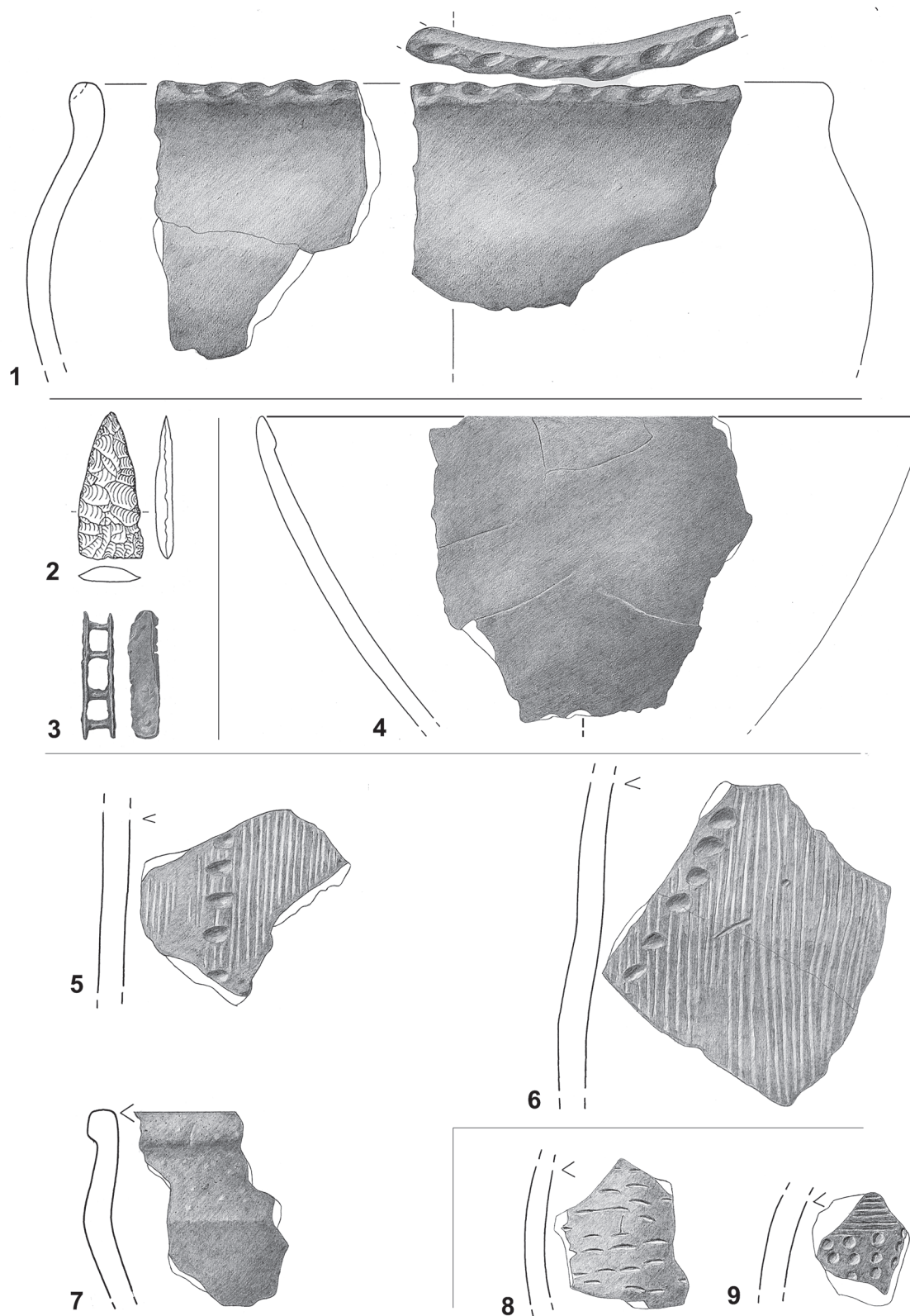

1: Katalognummer 165; 2 und 3: Katalognummer 184; 4: Katalognummer 306; 5–7: Katalognummer 282; 8 und 9: Katalognummer 315. – 1 und 4–9: Keramik; 2: Feuerstein; 3: Eisen. – 1, 3–9: M 1:2; 2: M 1:1.

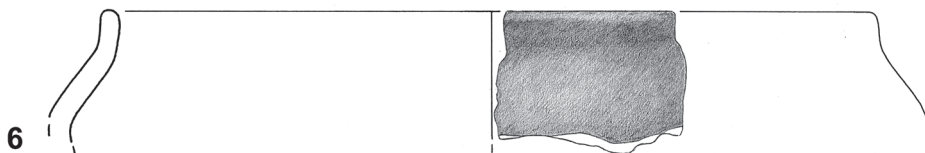
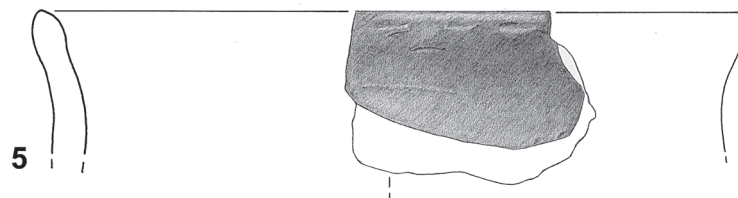
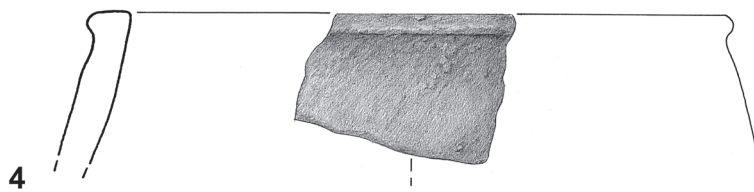
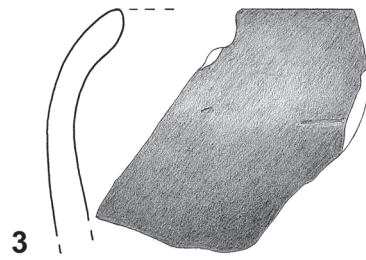
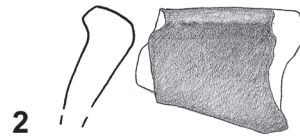
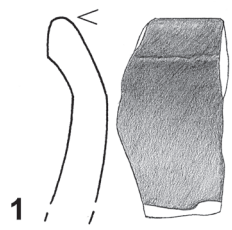

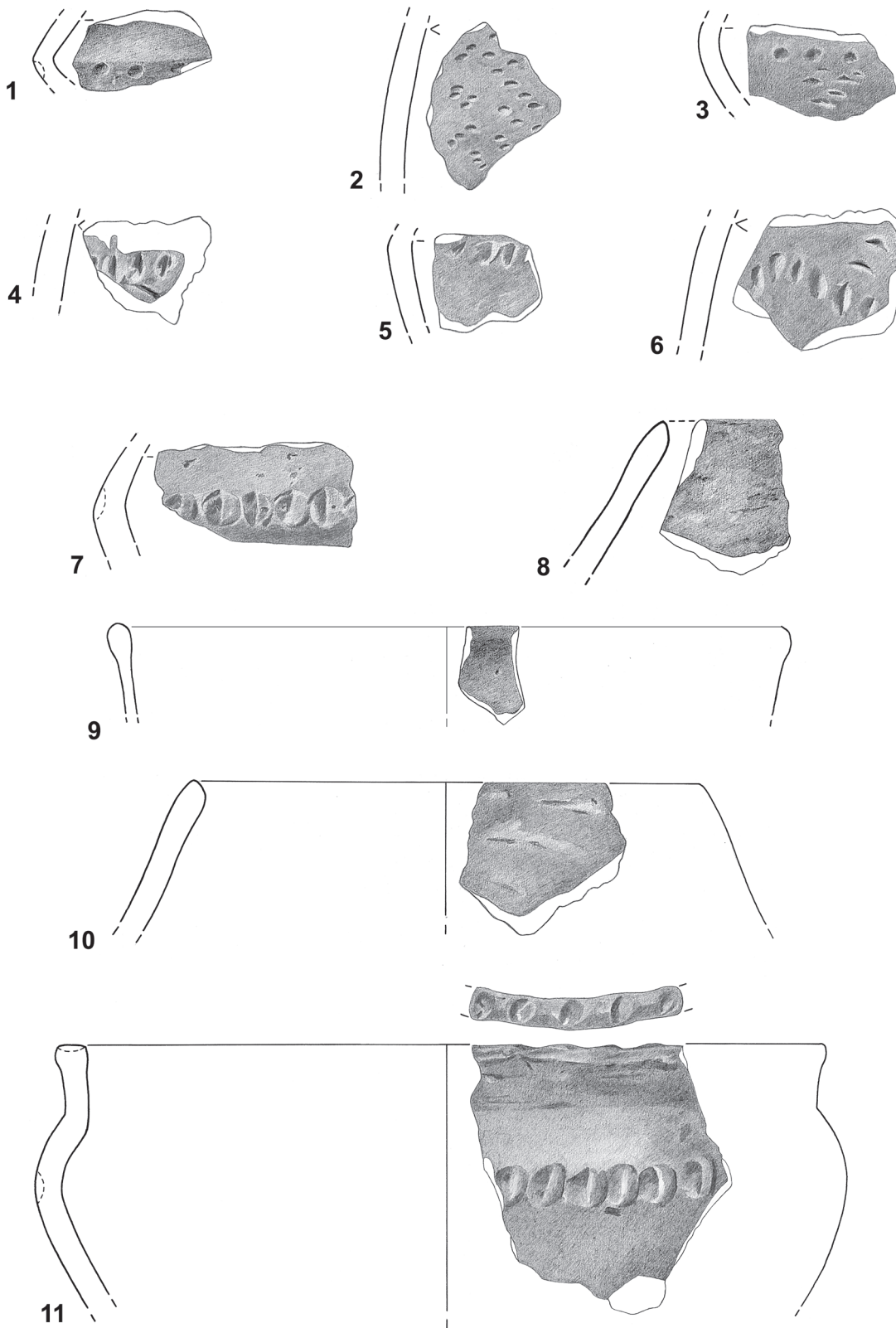

Katalognummer 320: 10: M 1:3; alle anderen M 1:2.

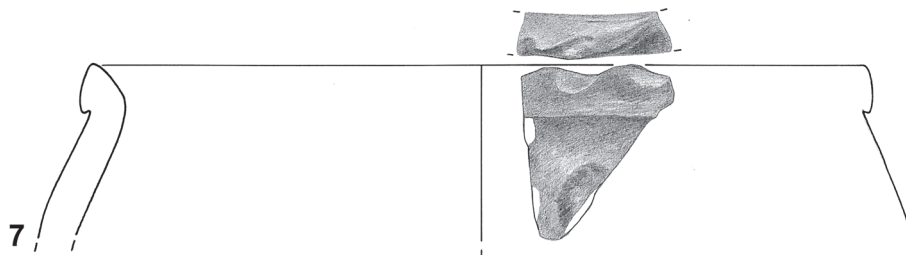
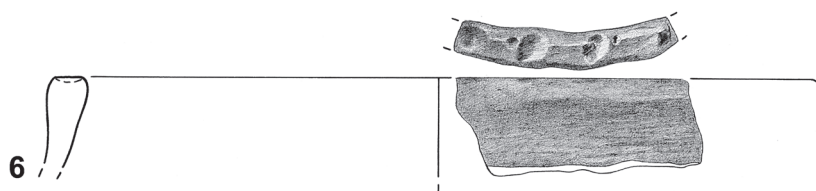
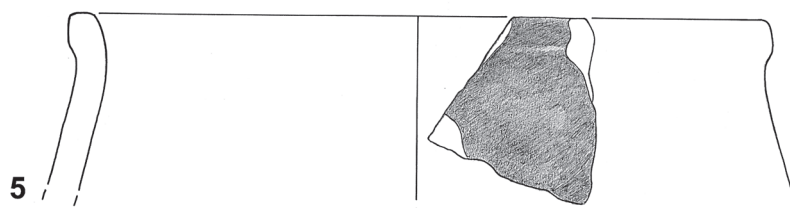
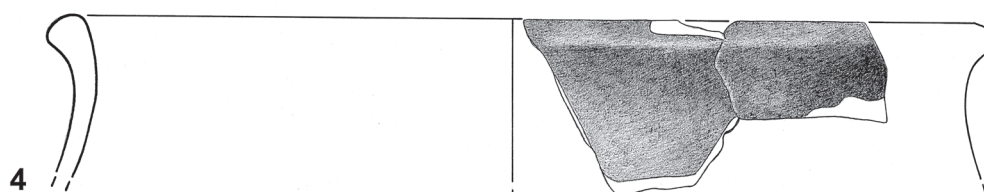
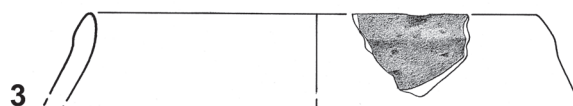
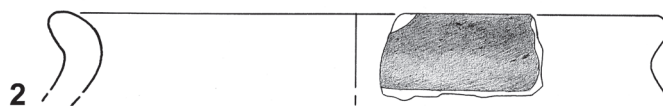
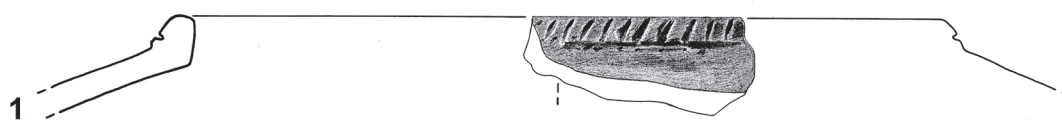

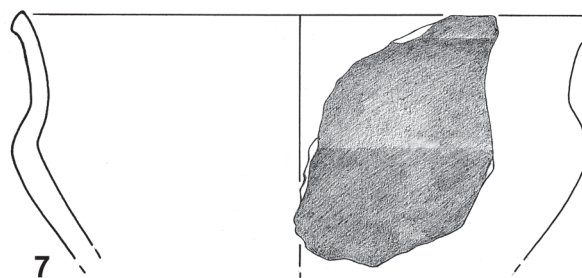
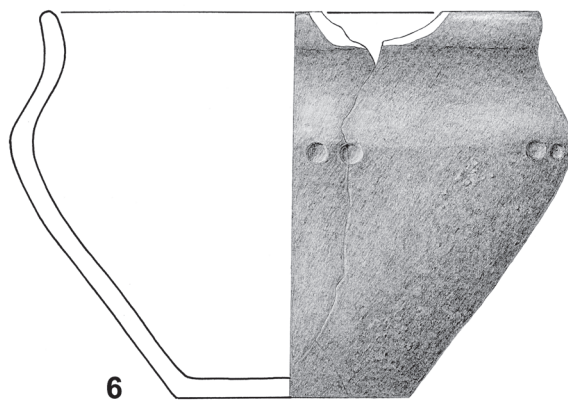
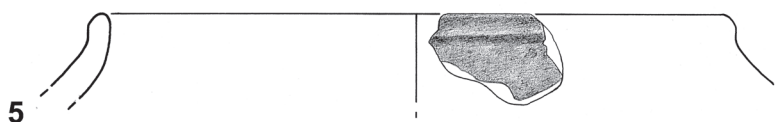
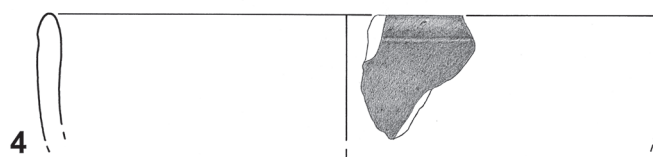
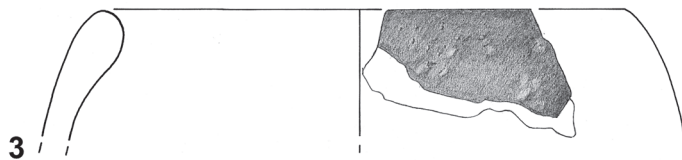
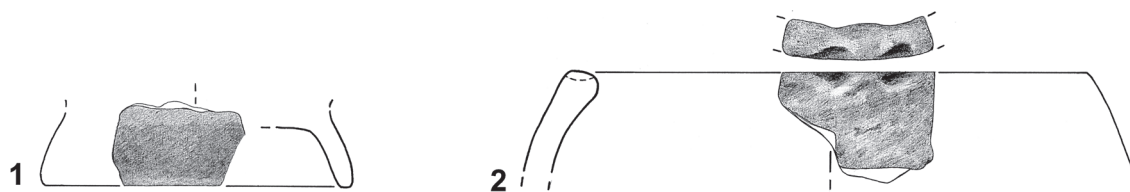

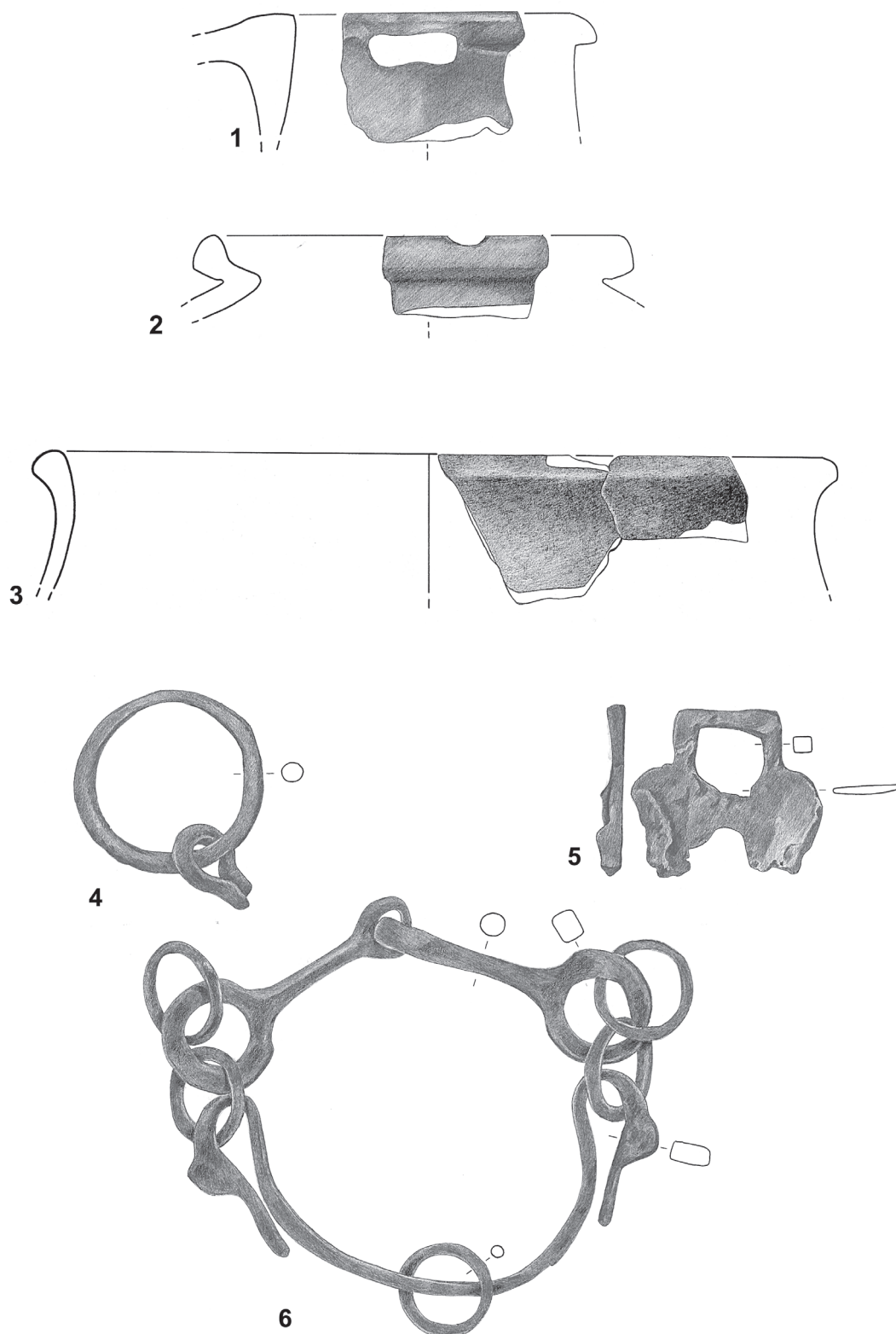

Katalognummer 320: 1–3: Keramik; 4–6: Eisen. – M 1:2.

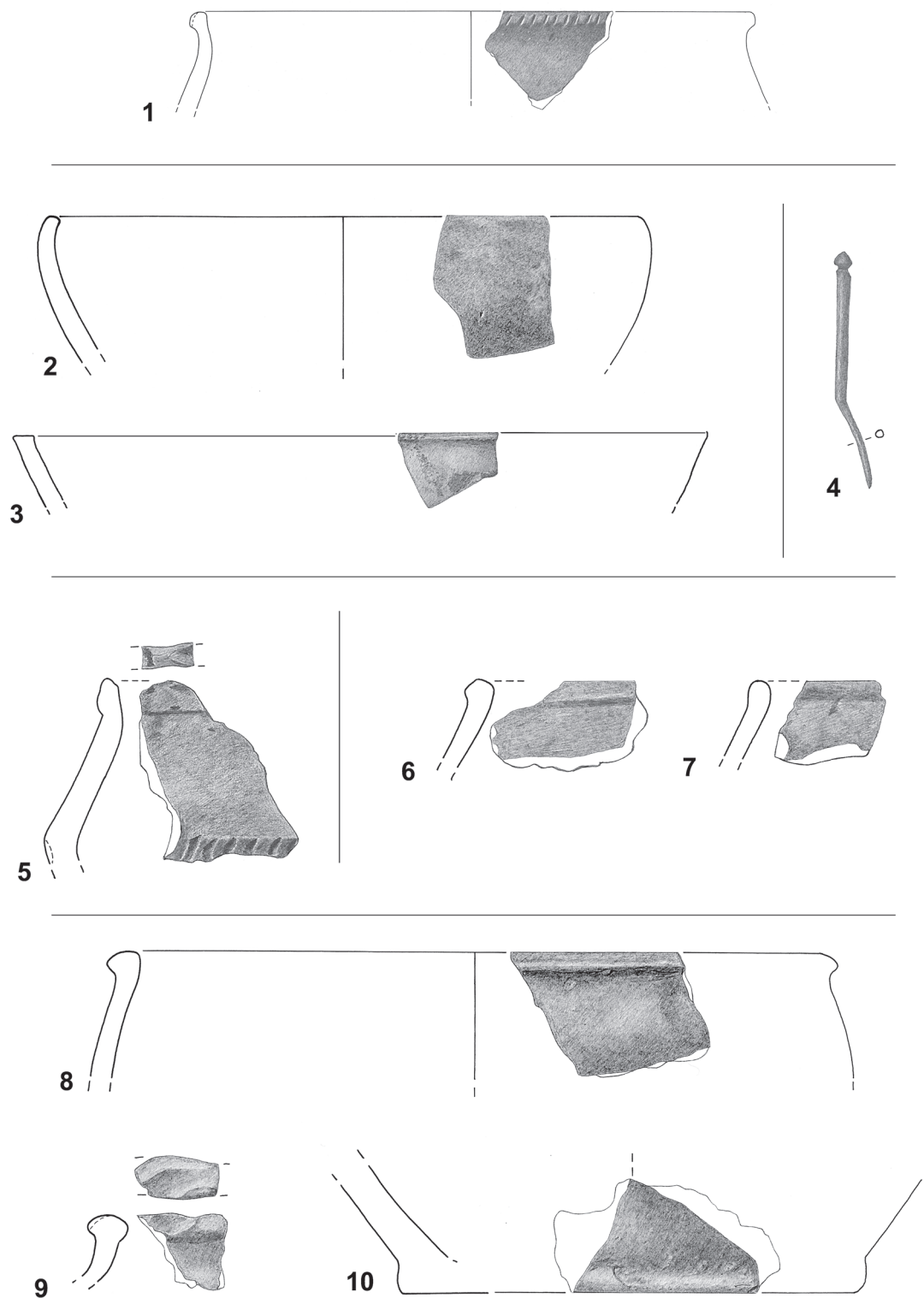

1: Katalognummer 387; 2 und 3: Katalognummer 319; 4: Katalognummer 336; 5: Katalognummer 321; 6 und 7: Katalognummer 334; 8–10: Katalognummer 406. – 1–3 und 5–10: Keramik; 4: Buntmetall. – 3: M 1:3; alle anderen: M 1:2.

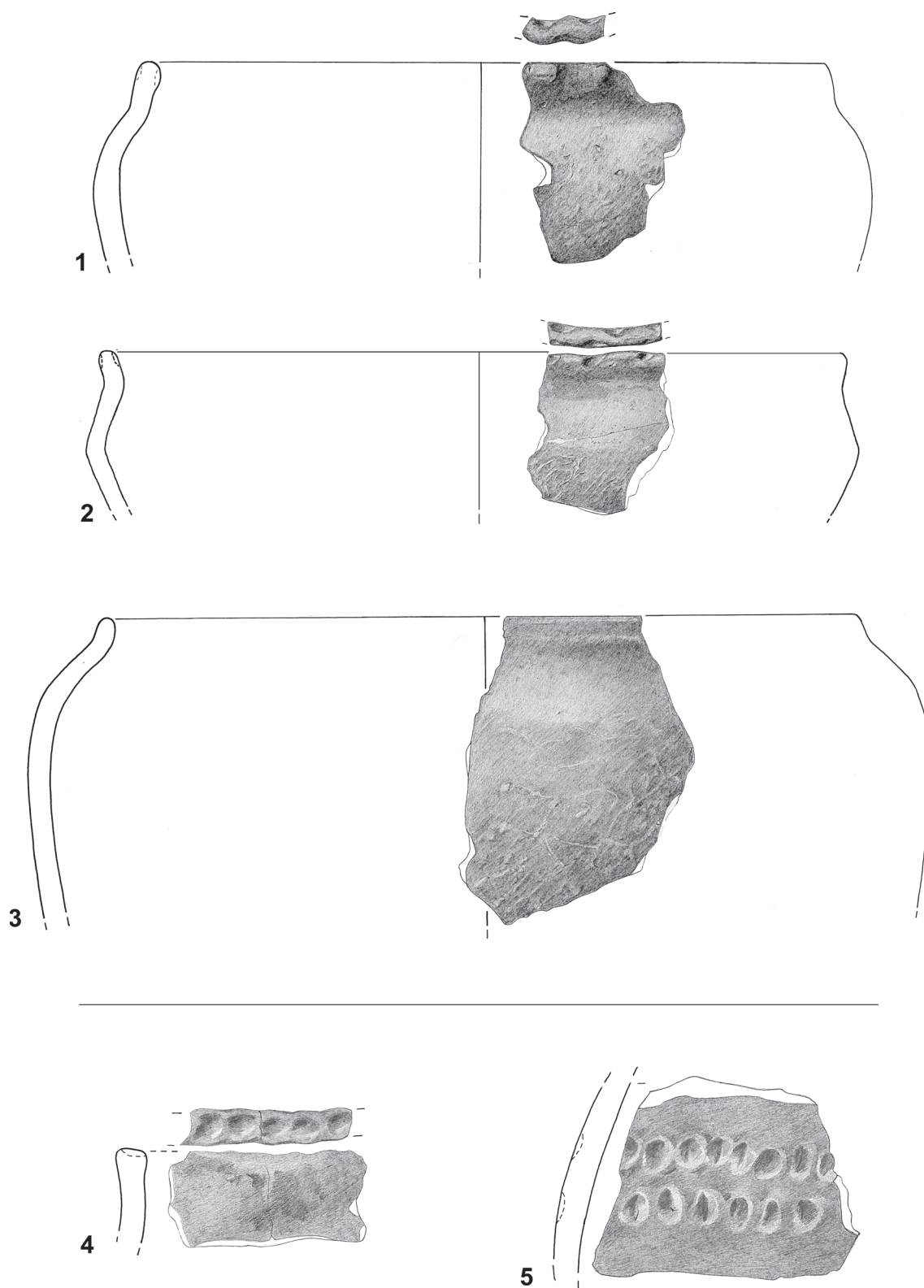

1–3: Katalognummer 406; 4: Katalognummer 414; 5: Katalognummer 529. – 2: M 1:3; alle anderen: M 1:2.

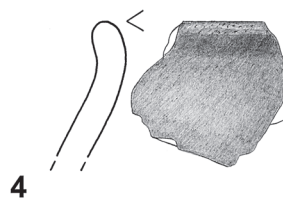
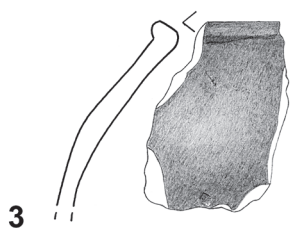
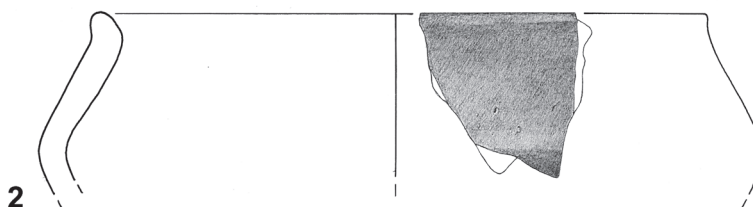
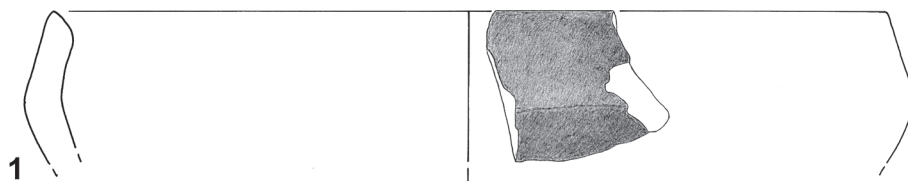

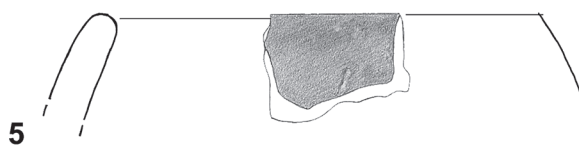
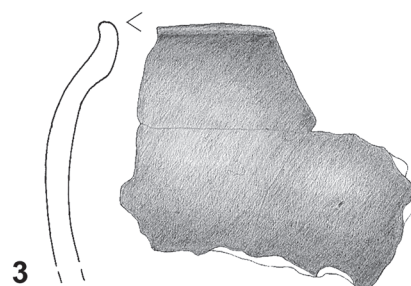
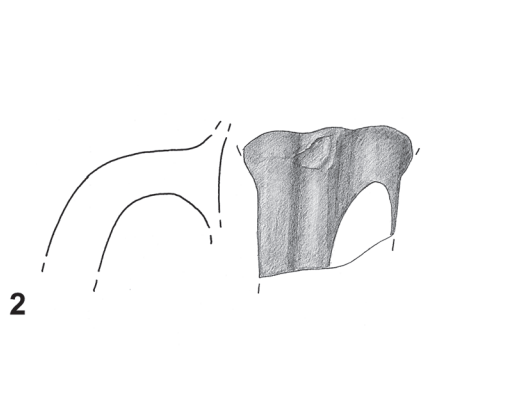
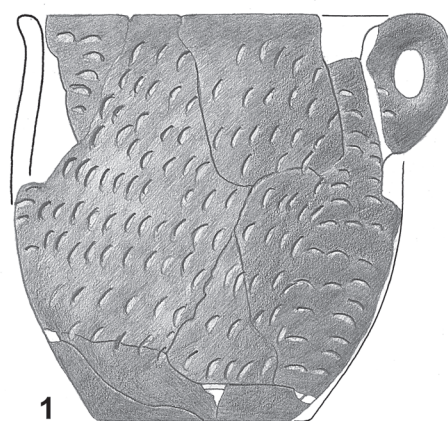

1: Katalognummer 479; 2: Katalognummer 494; 3-5: Katalognummer 501. - M 1:2.

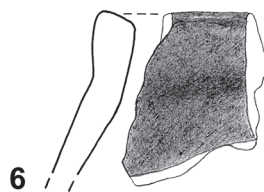
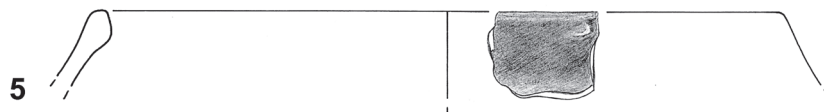
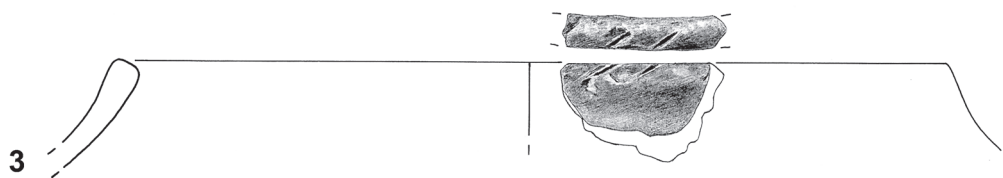
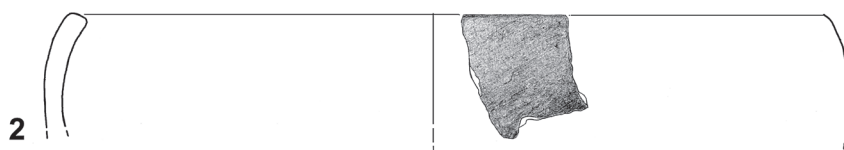
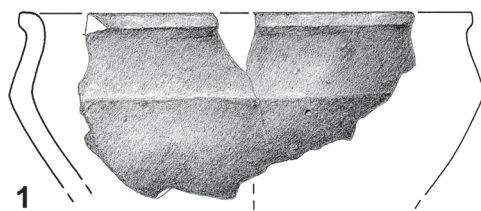

Katalognummer 512: 1, 3, 5 und 6: M 1:2; 2 und 4: M 1:3.

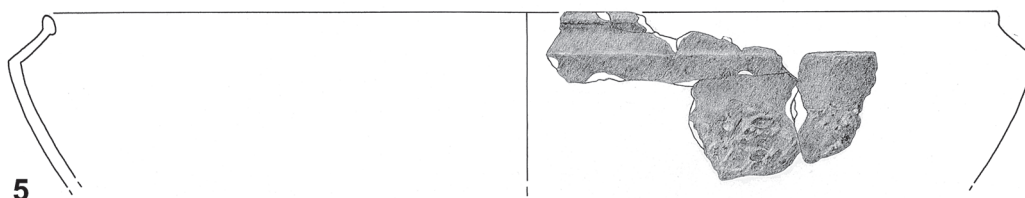
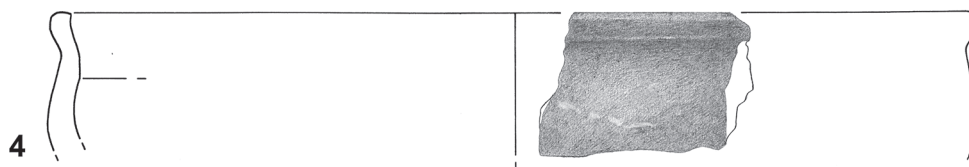
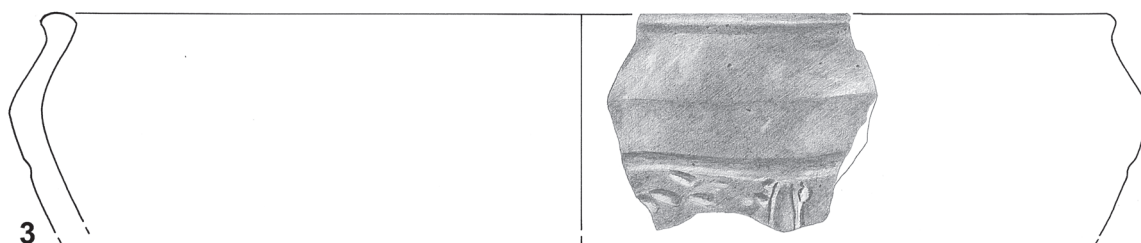
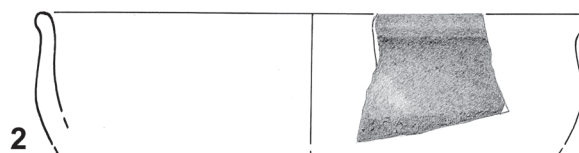
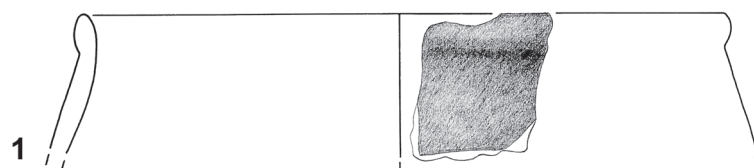

1: Katalognummer 522; 2: Katalognummer 531; 3–5: Katalognummer 545. – 5: M 1:4; alle anderen: M 1:2.

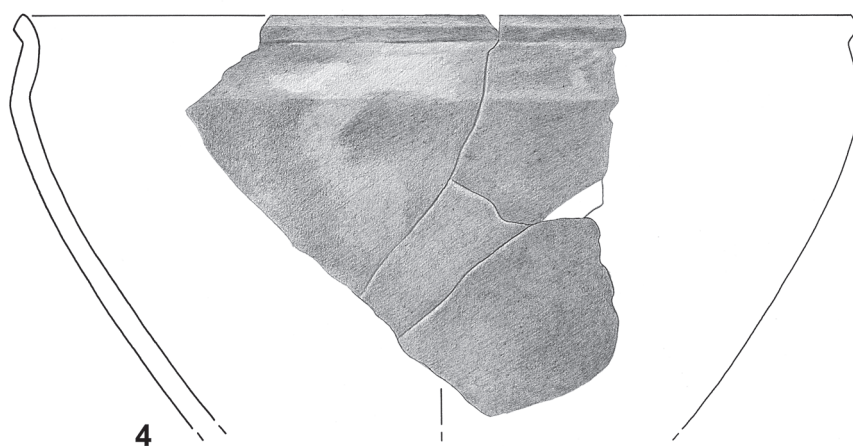
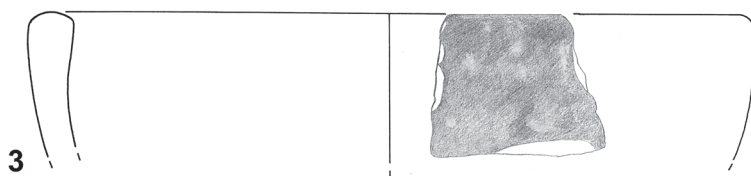
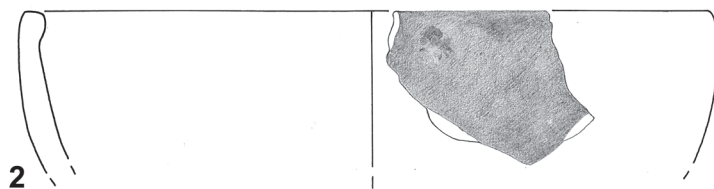
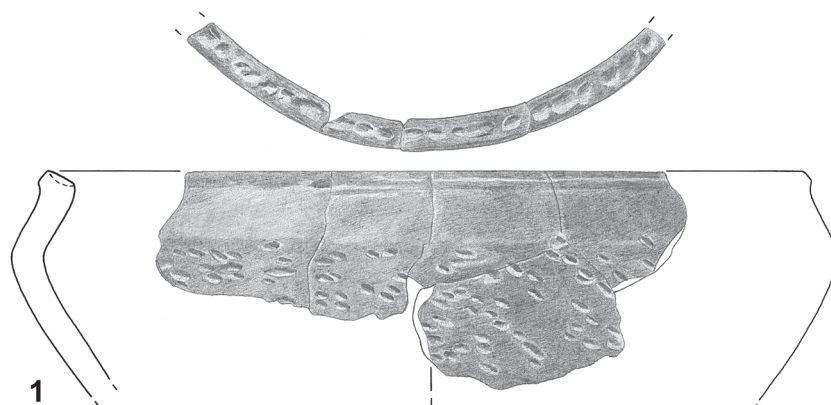

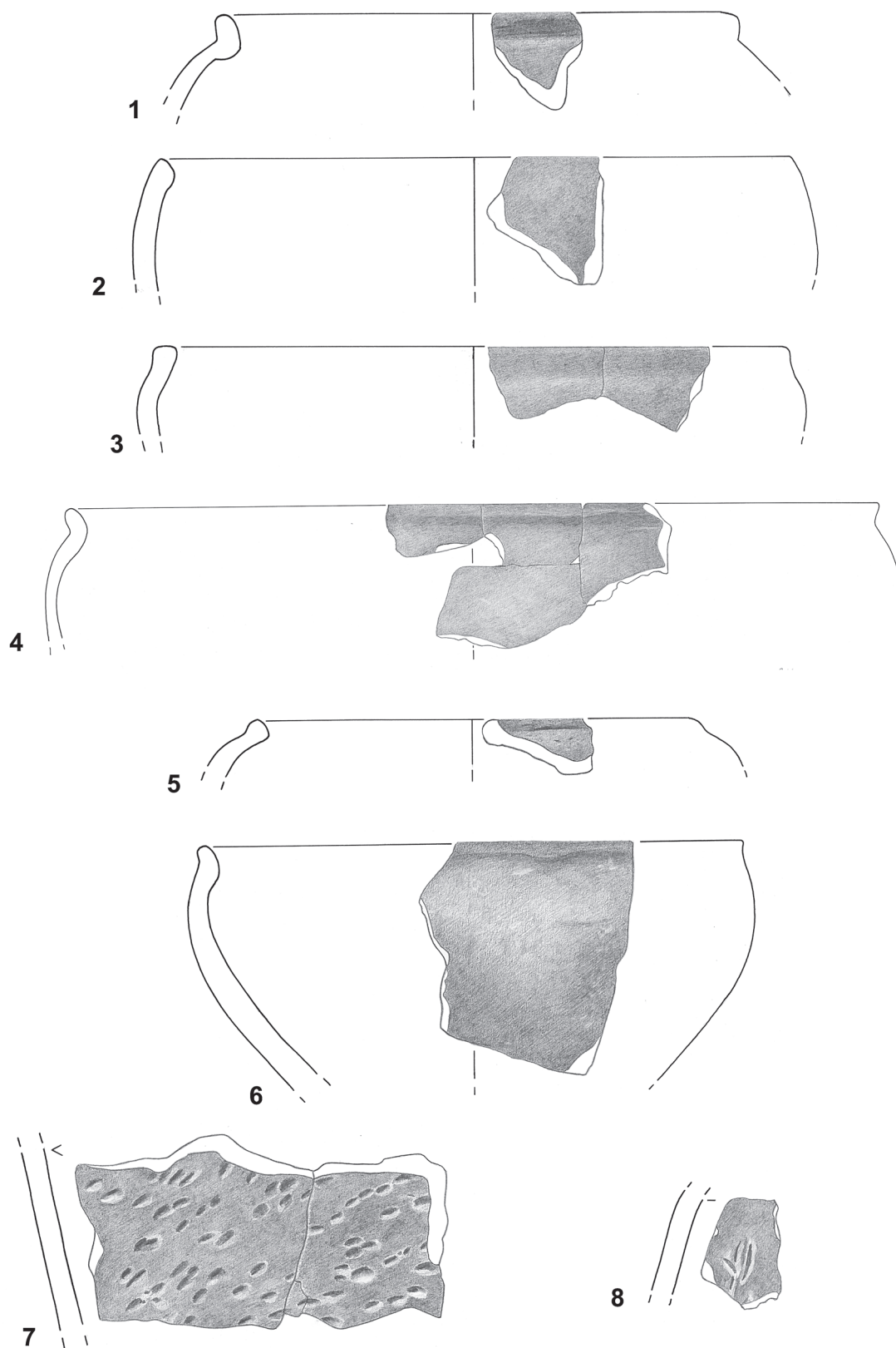

Katalognummer 547: 4: M 1:3; alle anderen: M 1:2.

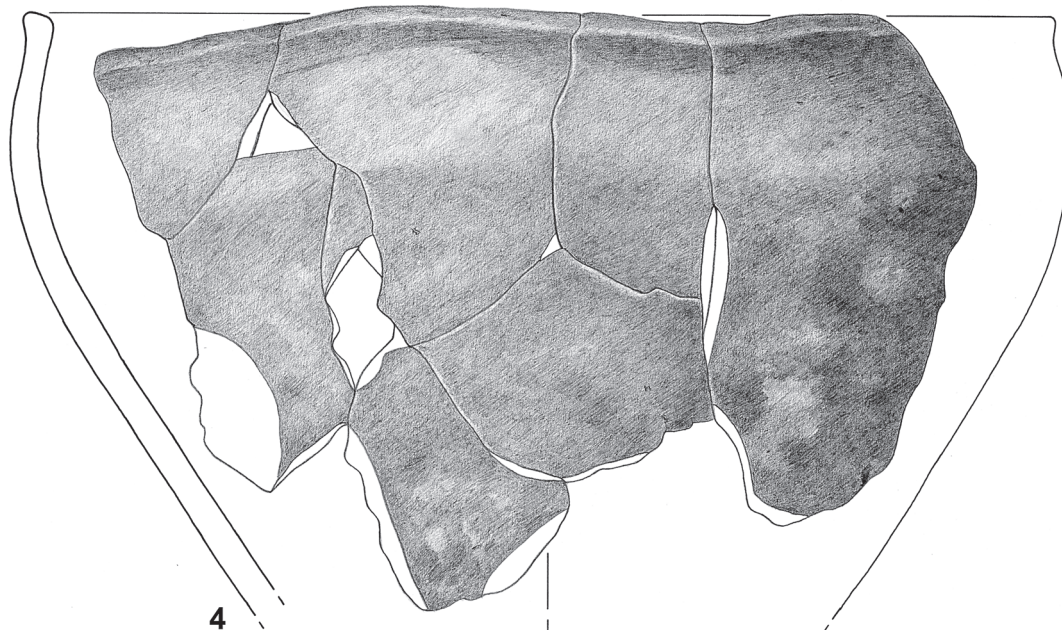
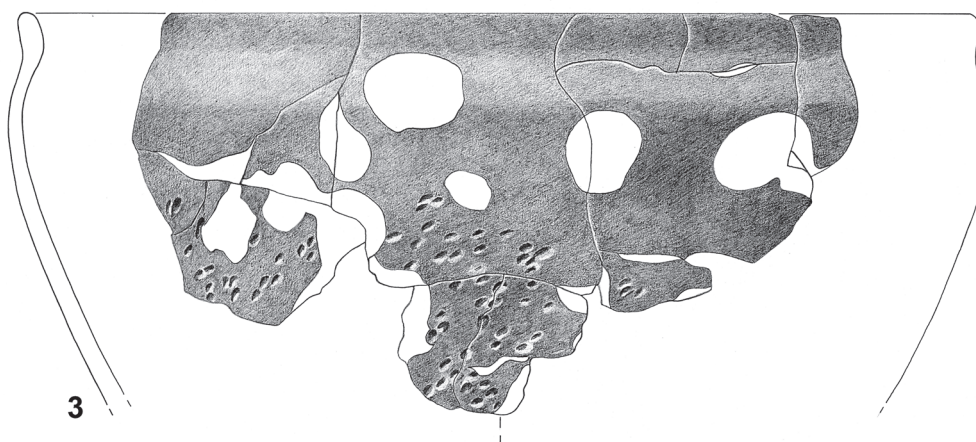
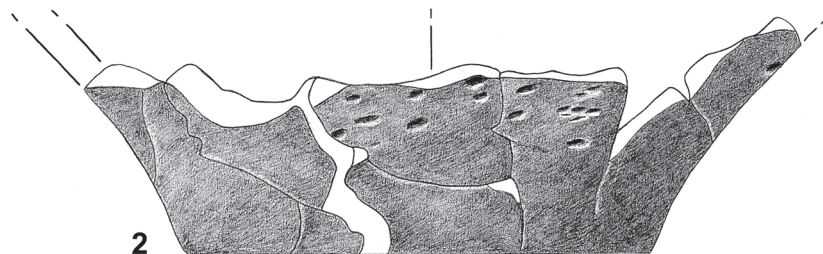
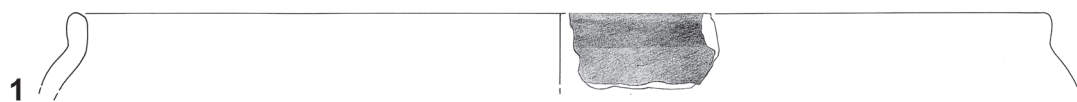

Katalognummer 547: 2 und 4: M 1:2; 1 und 3: M 1:3.

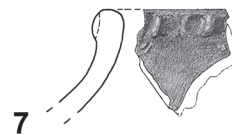
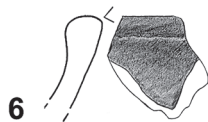
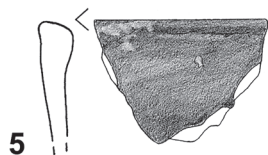
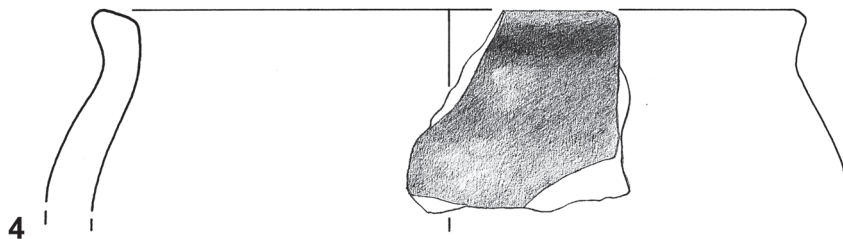
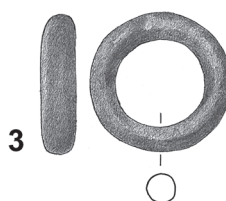
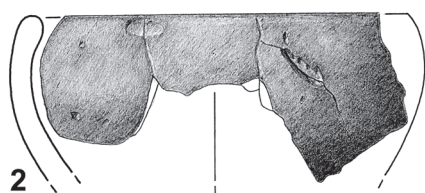
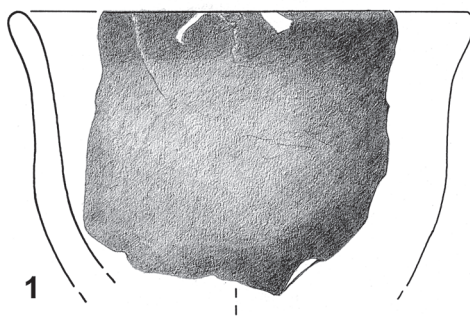

1: Katalognummer 552; 2 und 3: Katalognummer 558; 4: Katalognummer 556; 5–7: Katalognummer 557. –
3: Buntmetall; alle anderen: Keramik. – M 1:2.

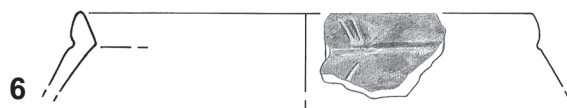
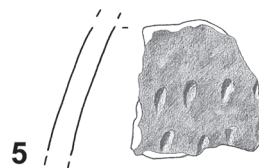
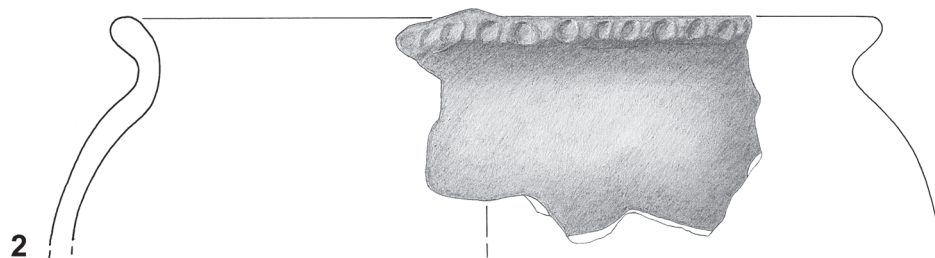
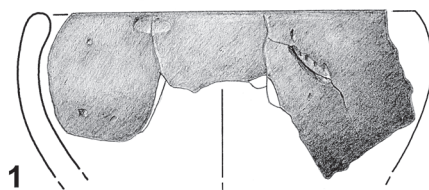

1 und 2: Katalognummer 574; 3–6: Katalognummer 586. – M 1:2.

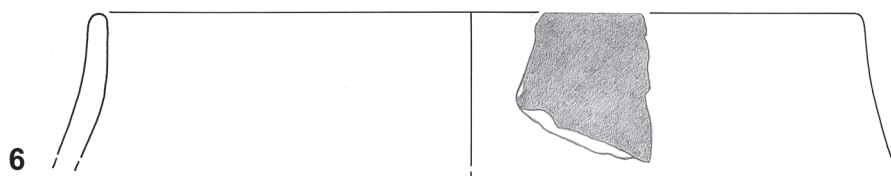
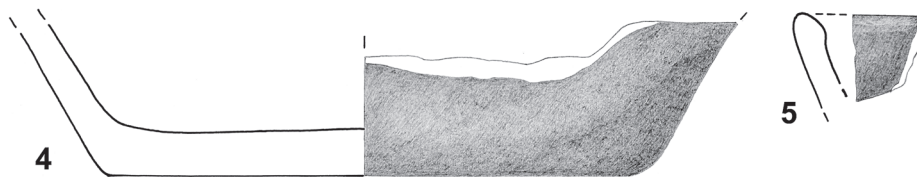
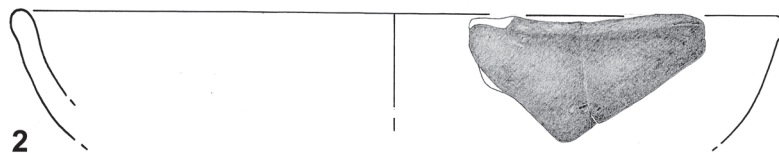
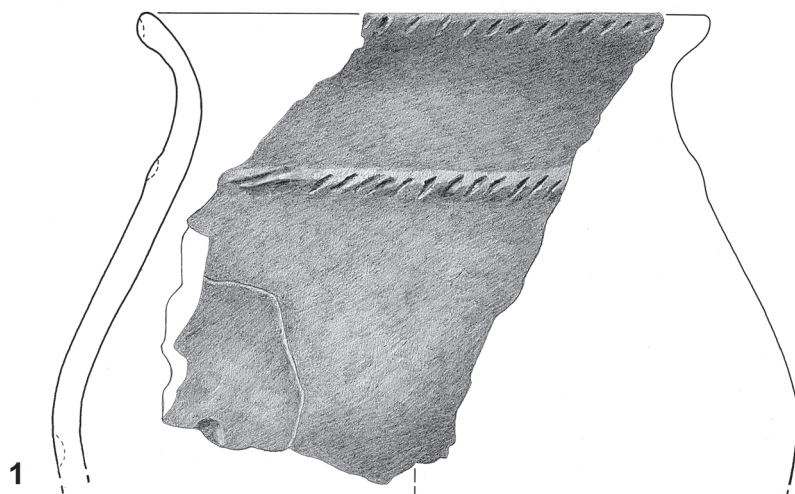

1: Katalognummer 592; 2-5: Katalognummer 619; 6: Katalognummer 634. – M 1:2.

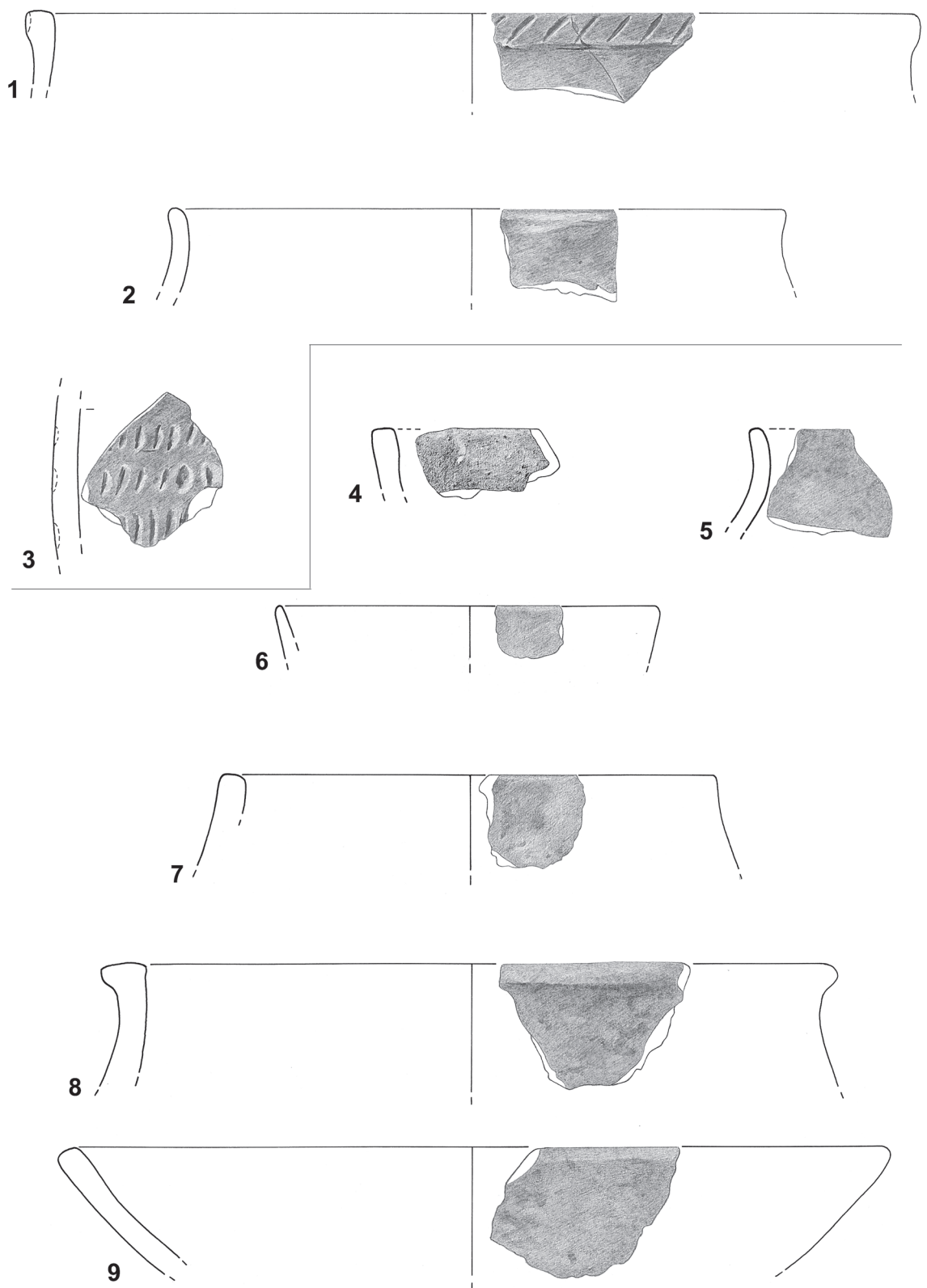

1-3: Katalognummer 641; 4-9: Katalognummer 667. – M 1:2.

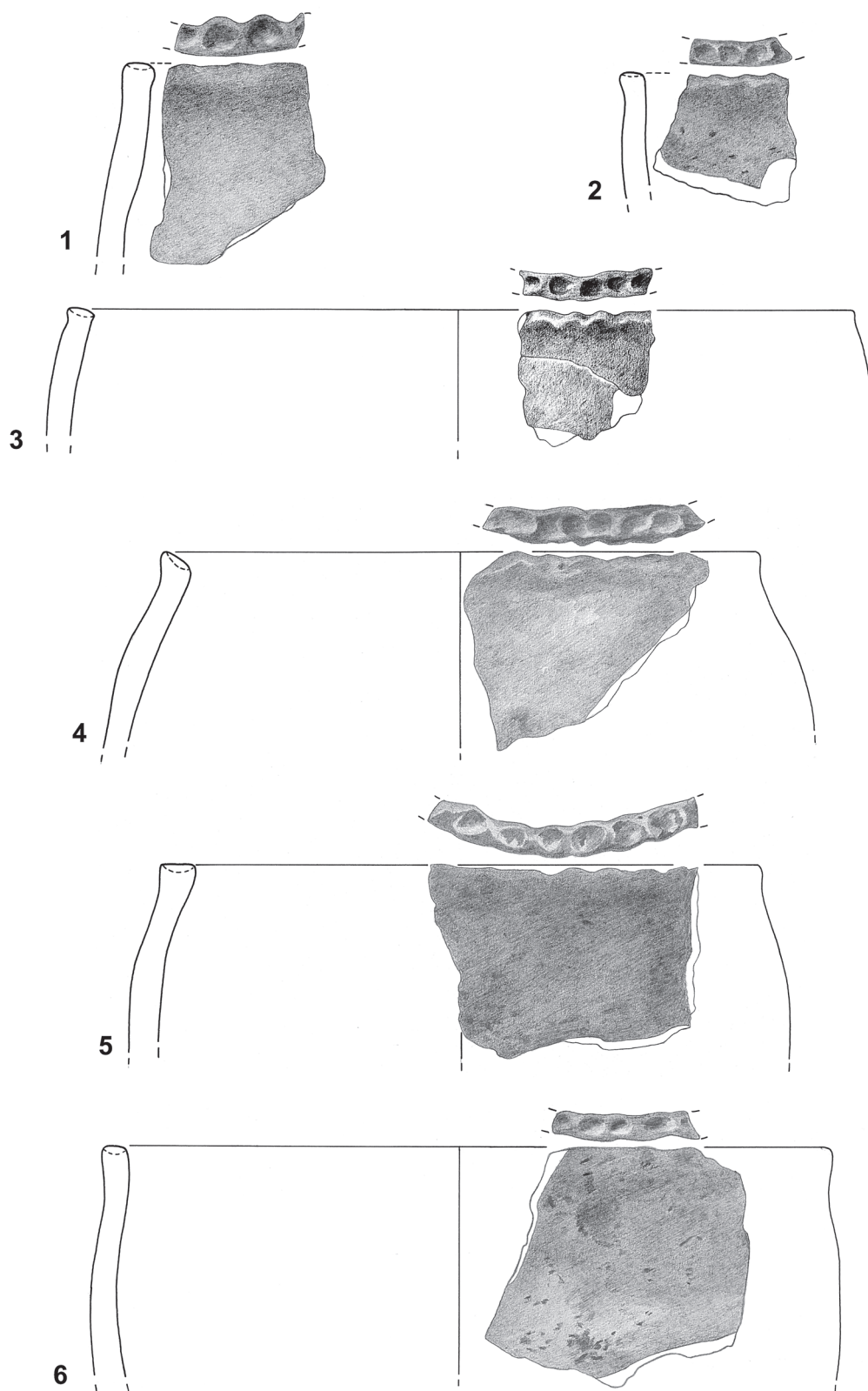

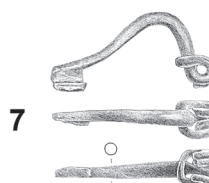
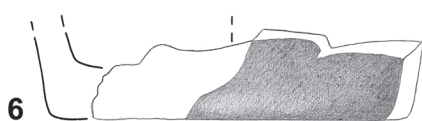
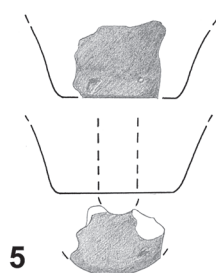
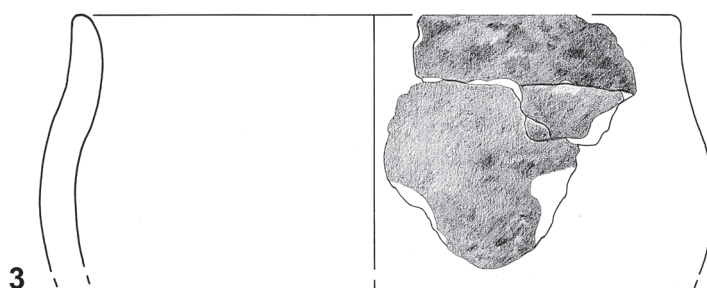
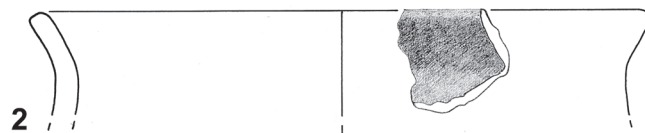
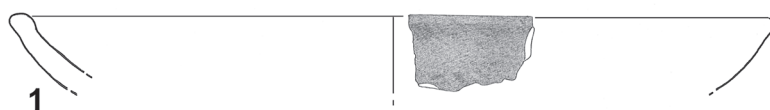

1–3: Katalognummer 667; 4–7: Katalognummer 726. – 1–6: Keramik; 7: Kupferlegierung. –
1 und 5: M 1:3; alle anderen: M 1:2.

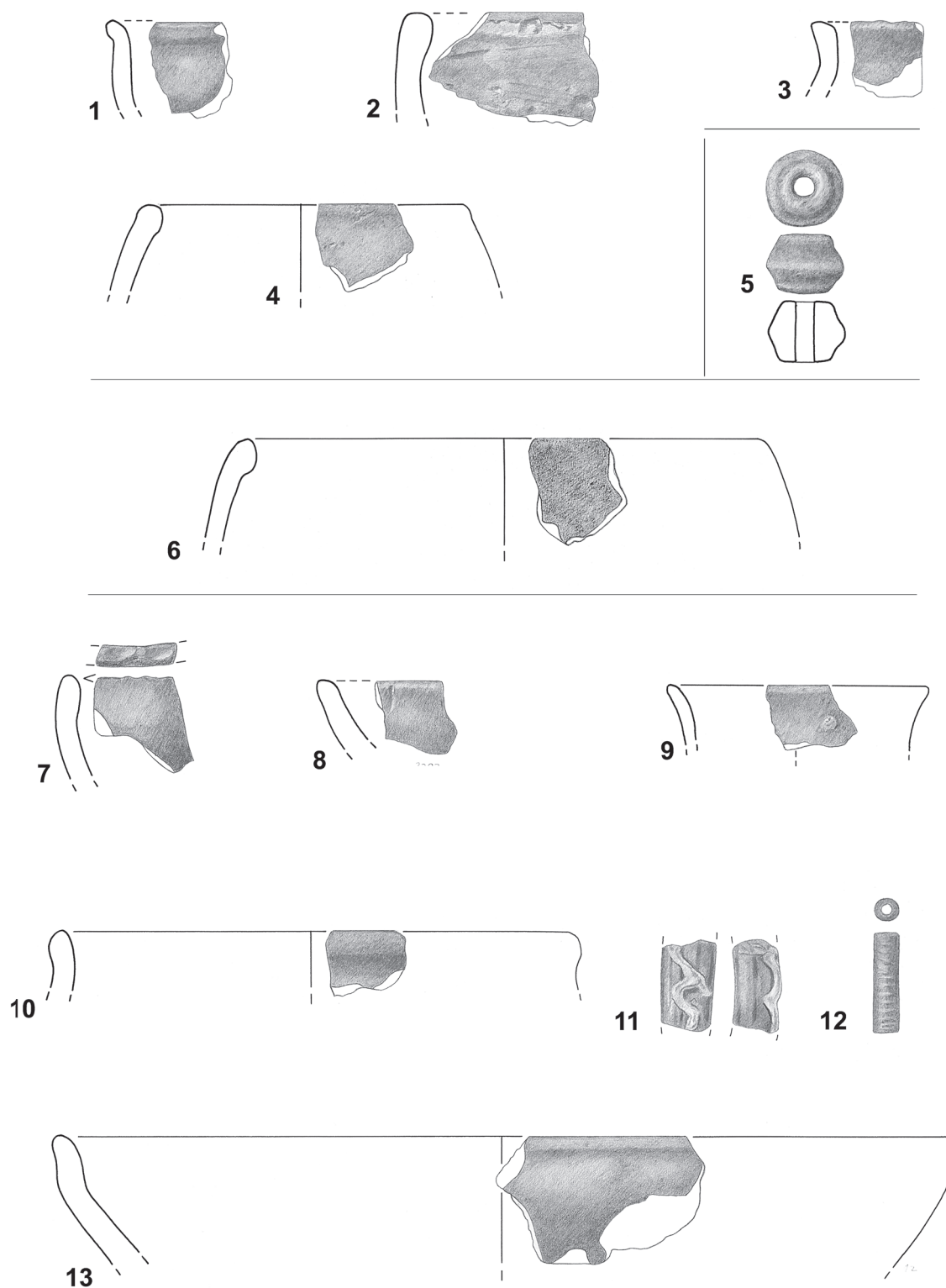

1–4: Katalognummer 726; 5: Katalognummer 750; 6: Katalognummer 778; 7–13: Katalognummer 884. –
 11: Glas, M 1:1; alle anderen: Keramik, M 1:2.

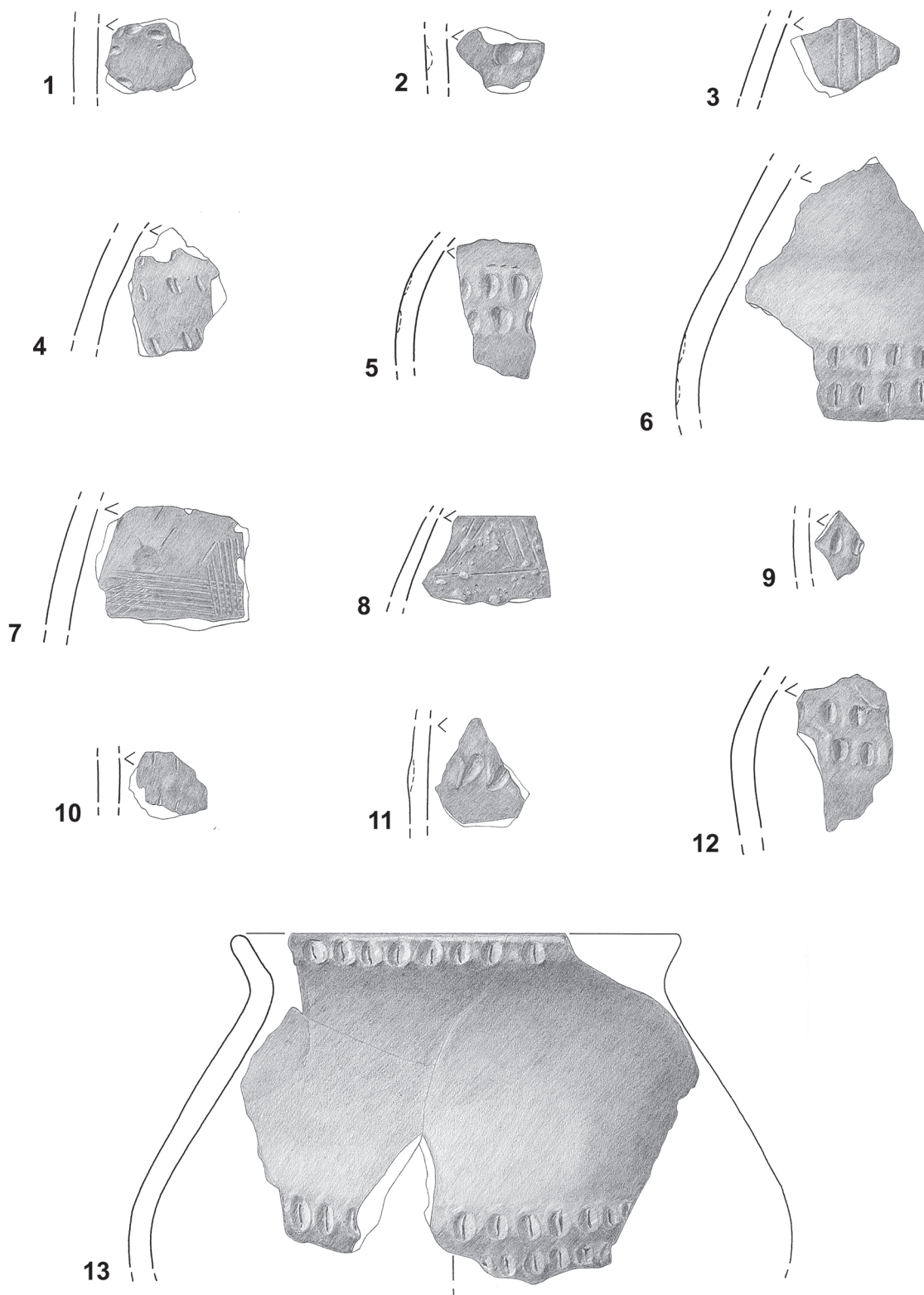

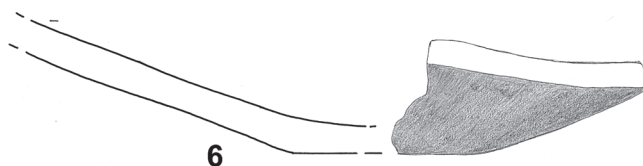
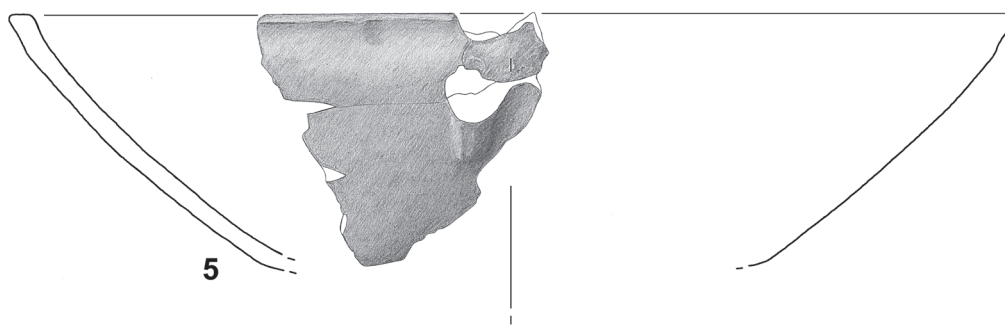
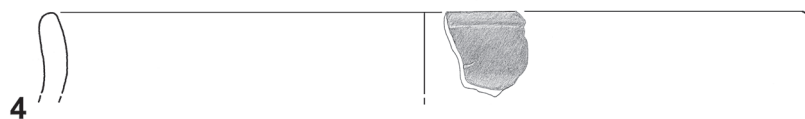
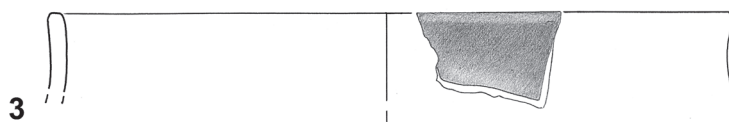
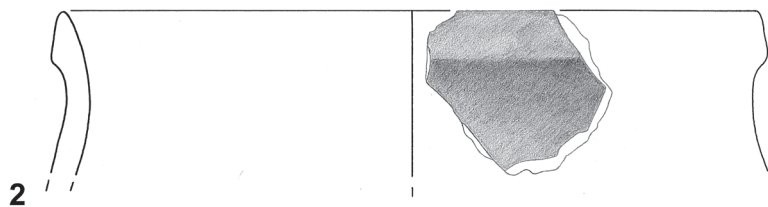
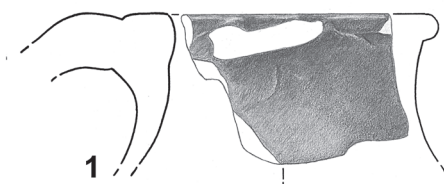

Katalognummer 884: 3 und 4: M 1:3; alle anderen: M 1:2.

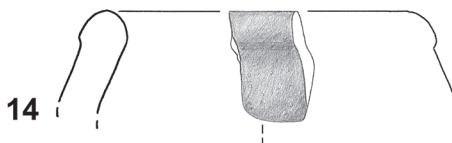
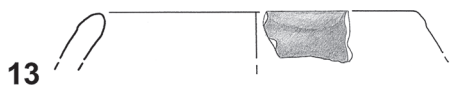
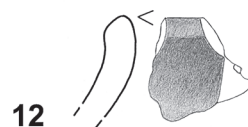
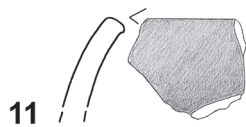
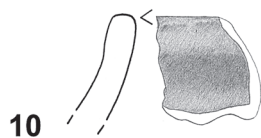
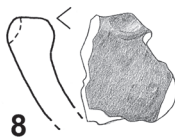
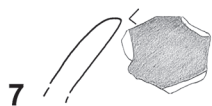
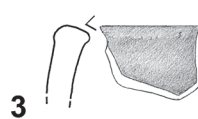
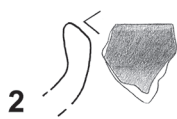
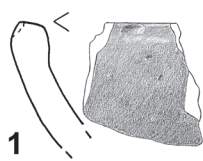

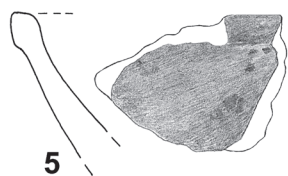
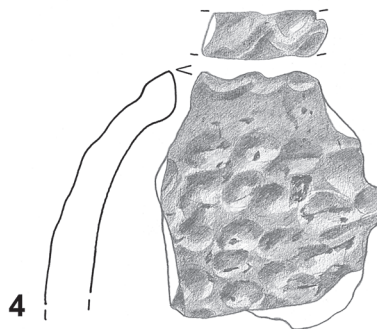
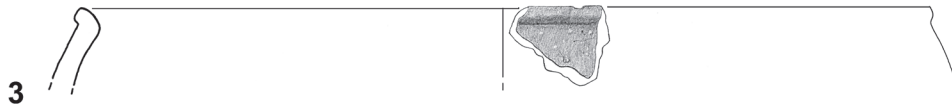
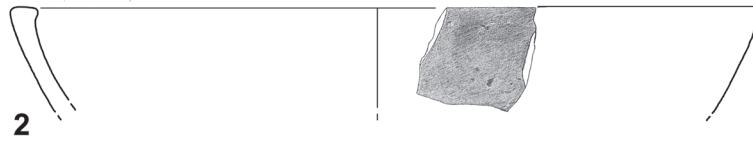
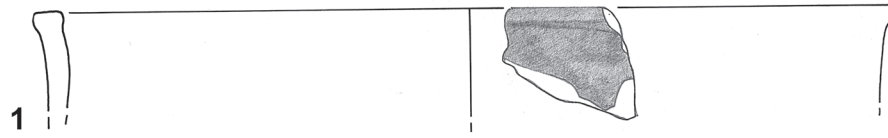

1: Katalognummer 983; 2: Katalognummer 899; 3: Katalognummer 911; 4: Katalognummer 906; 5: Katalognummer 919;
6: Katalognummer 972. – 2 und 3: M 1:3; alle anderen: M 1:2.

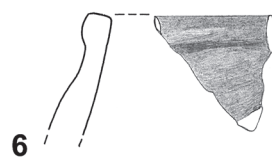
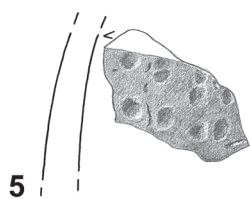
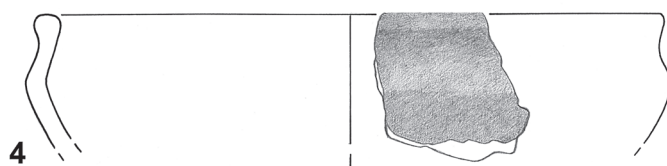
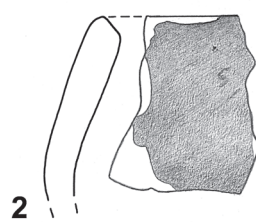
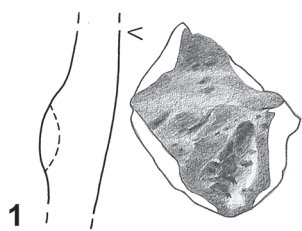

1 und 2: Katalognummer 964; 3–5: Katalognummer 966; 6: Katalognummer 984. – 3: M 1:3; alle anderen M 1:2.

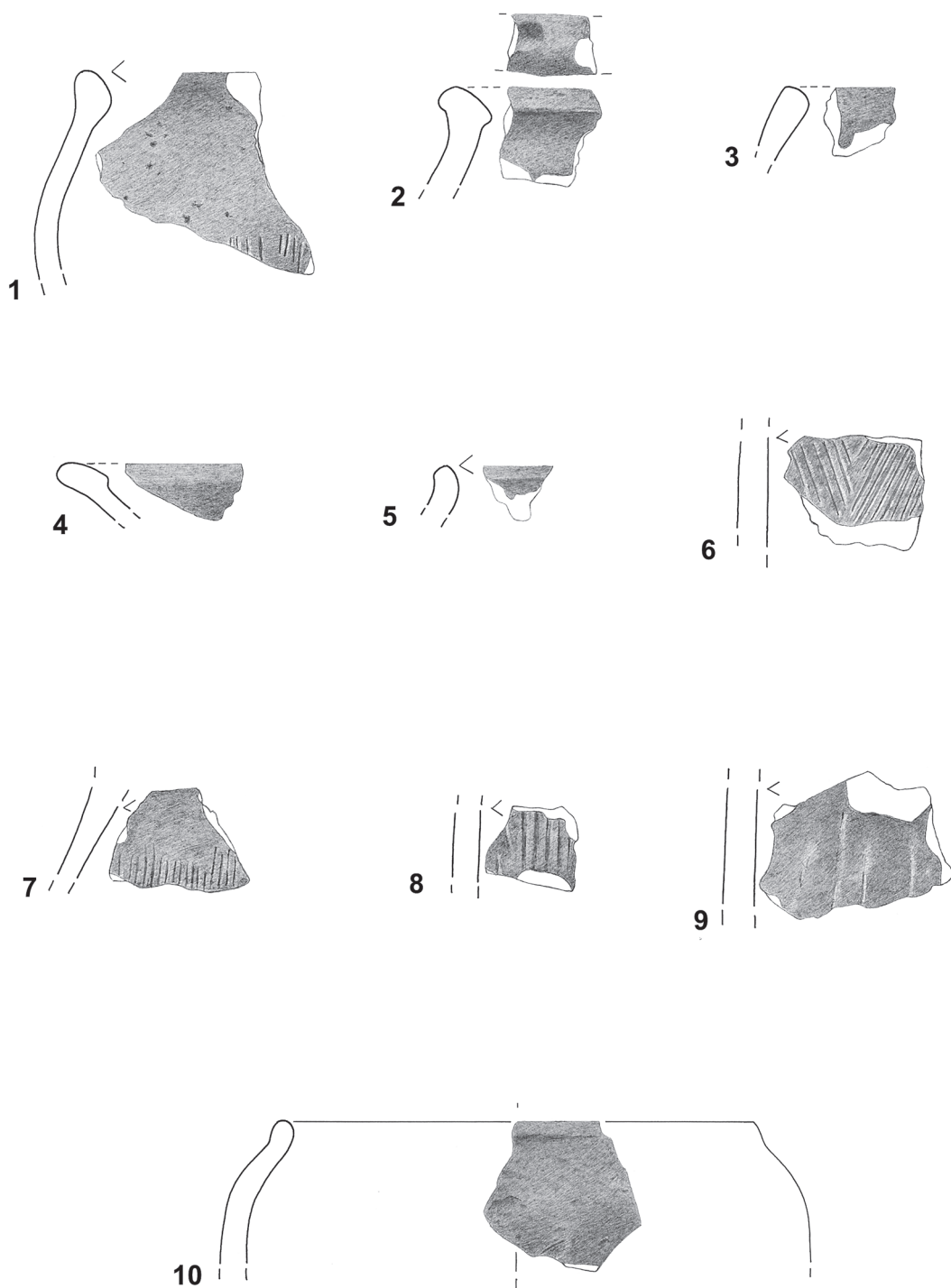

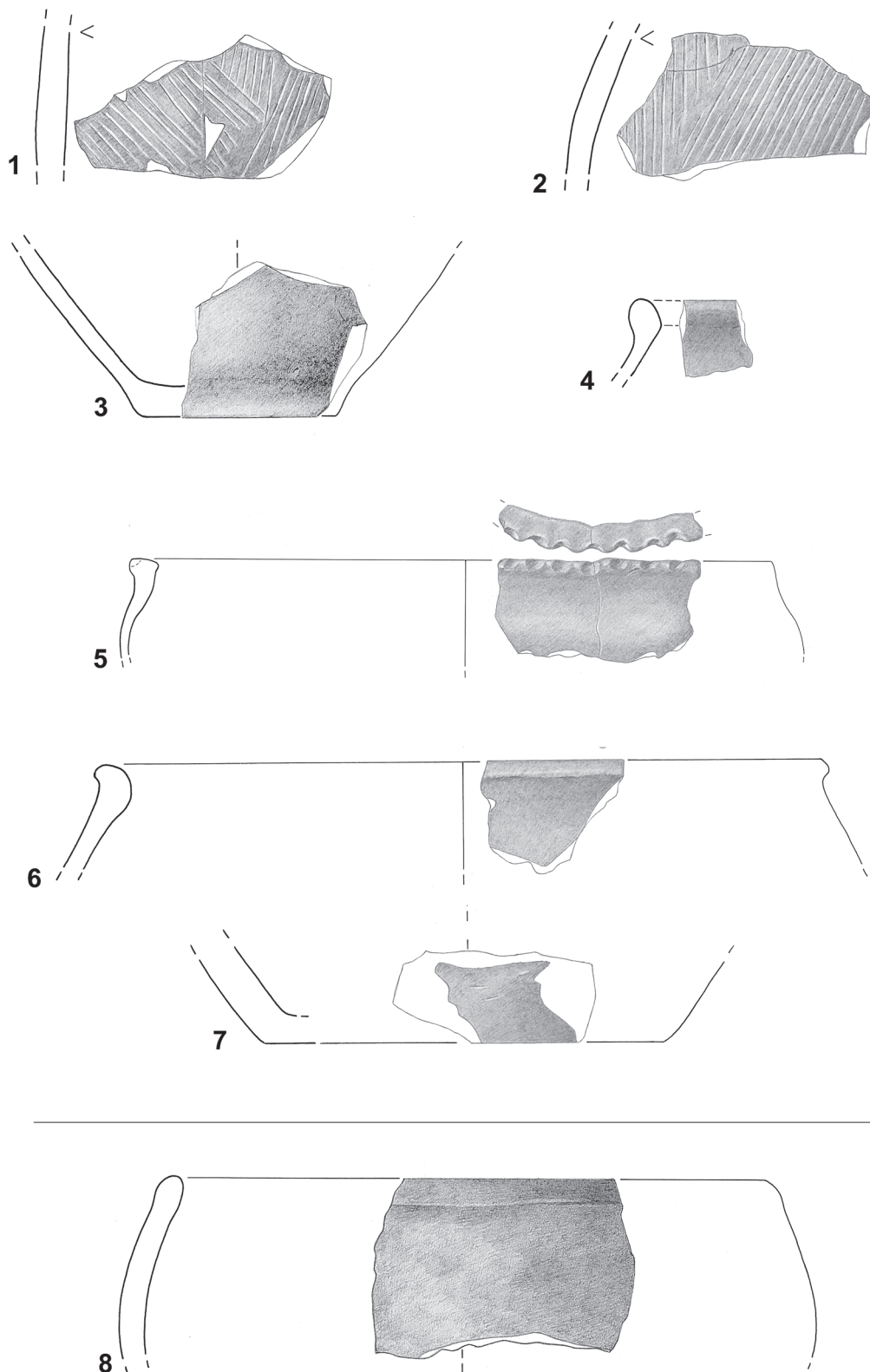

1–7: Katalognummer 1061; 8: Katalognummer 1081. – M 1:2.

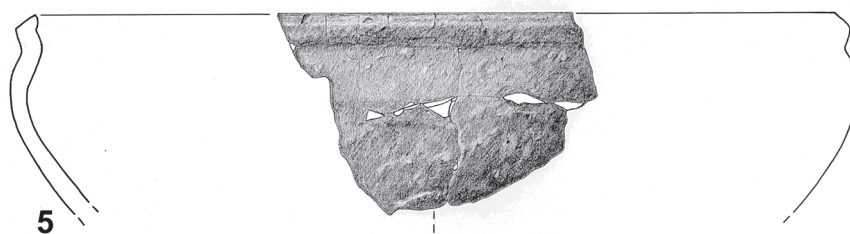
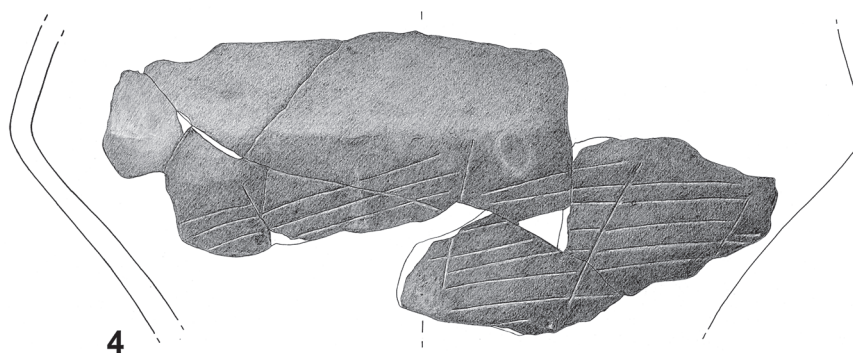
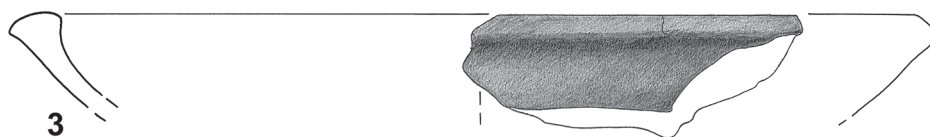
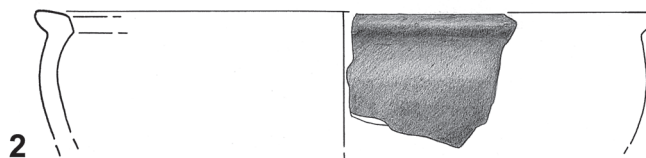
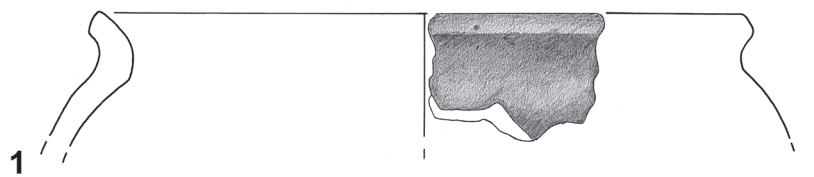

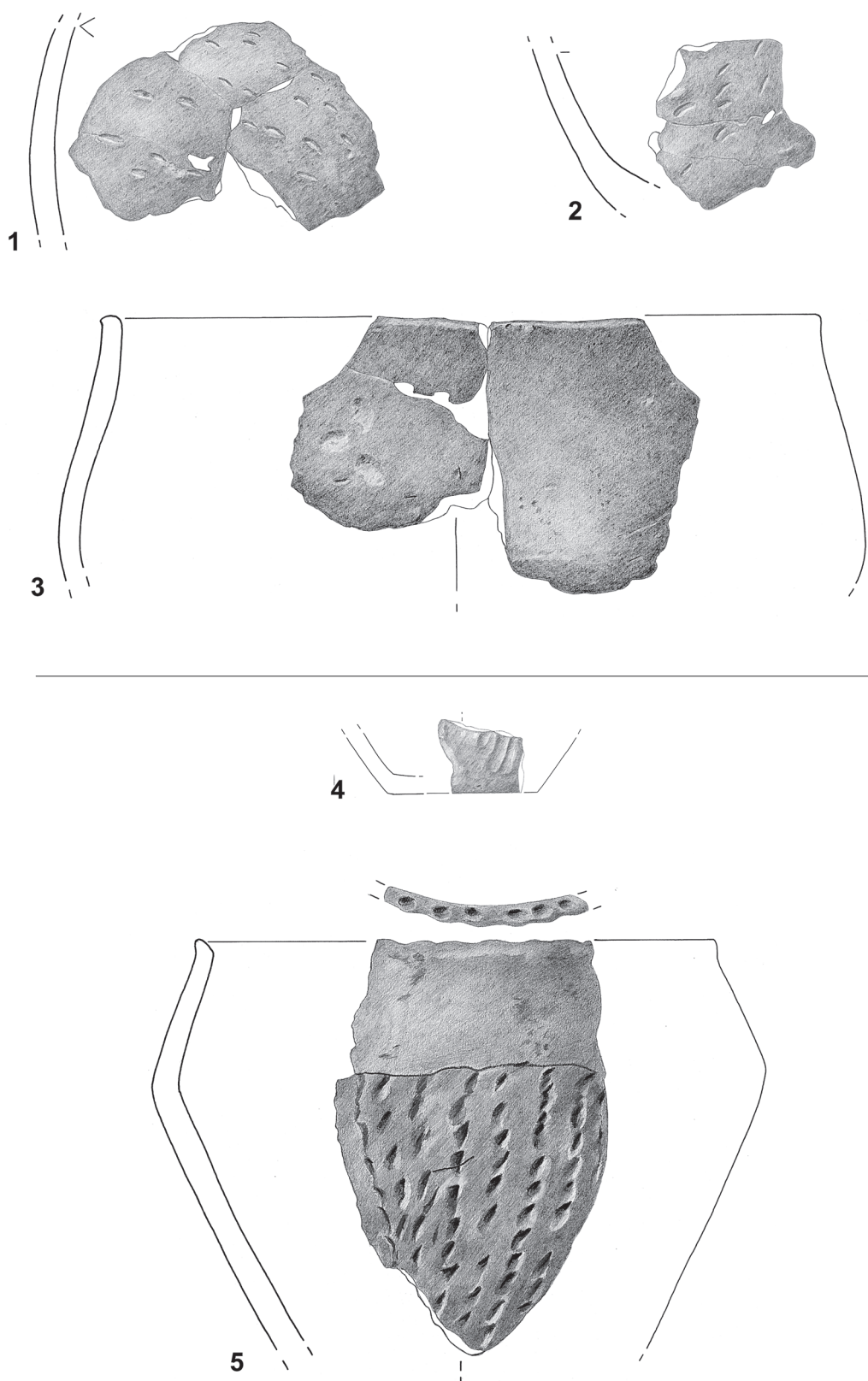

1-3: Katalognummer 1206; 4 und 5: Katalognummer 1224. – M 1:2.

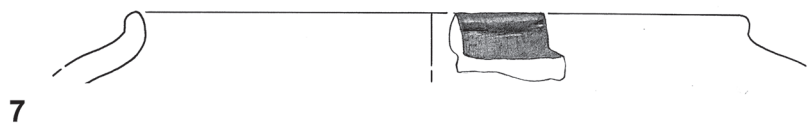
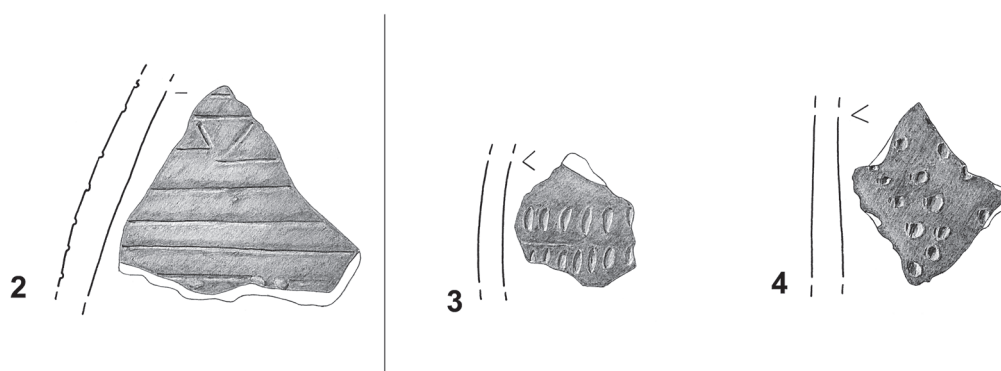
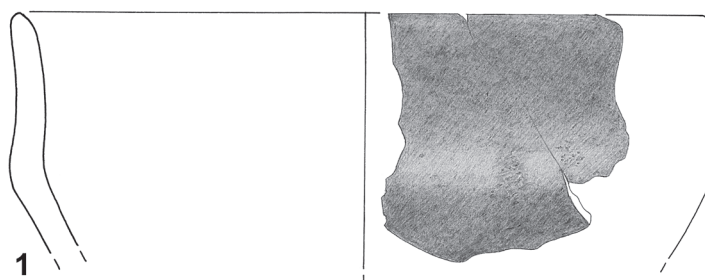

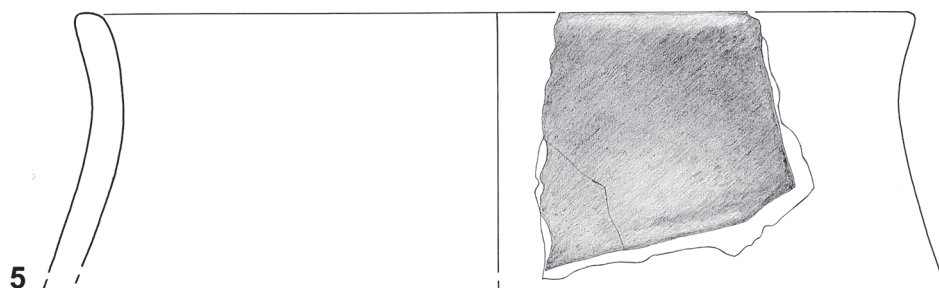
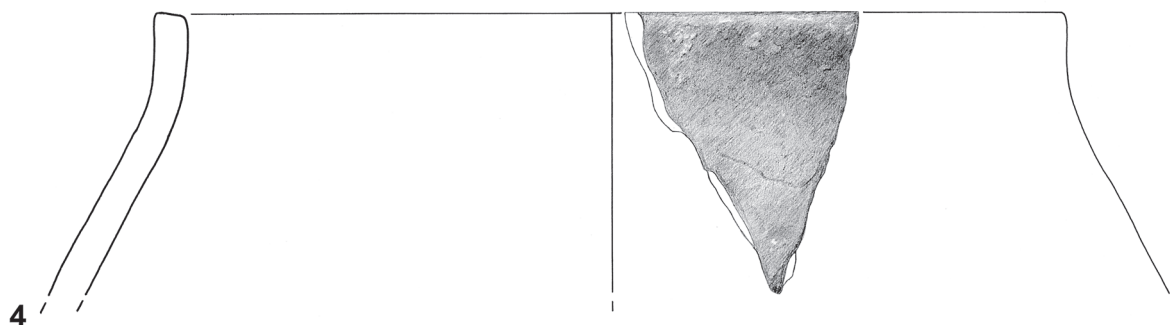
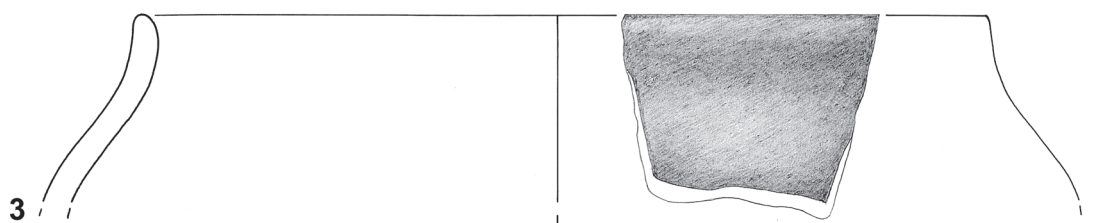
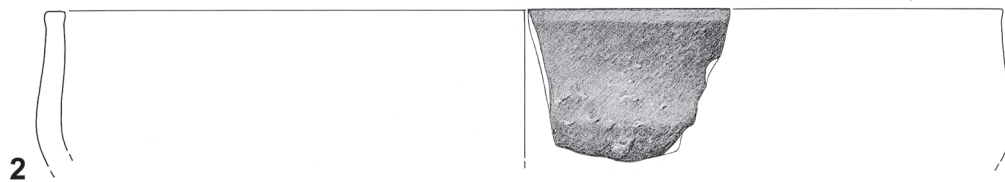

Katalognummer 1474: 2: M 1:3; alle anderen M 1:2.

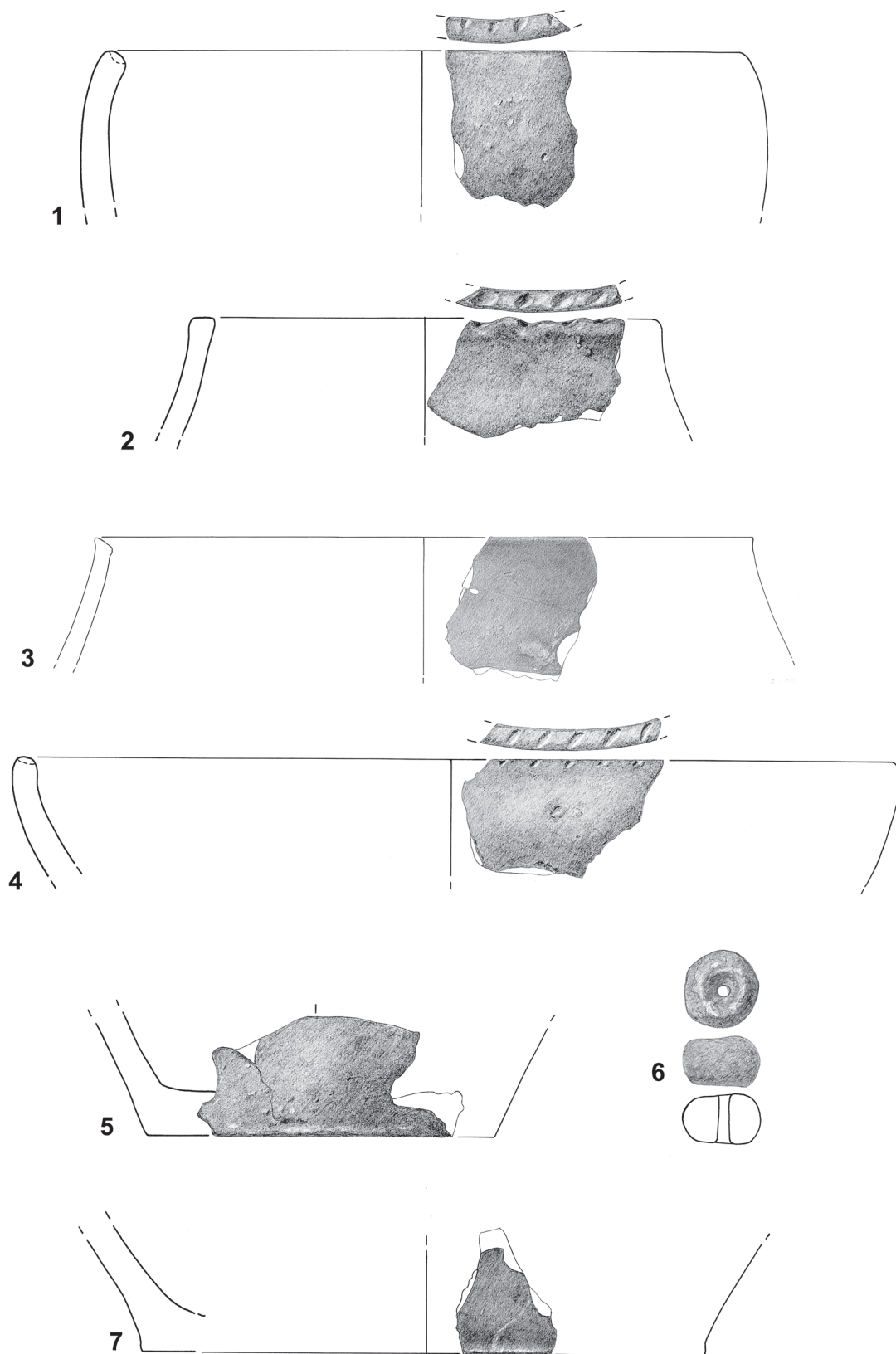

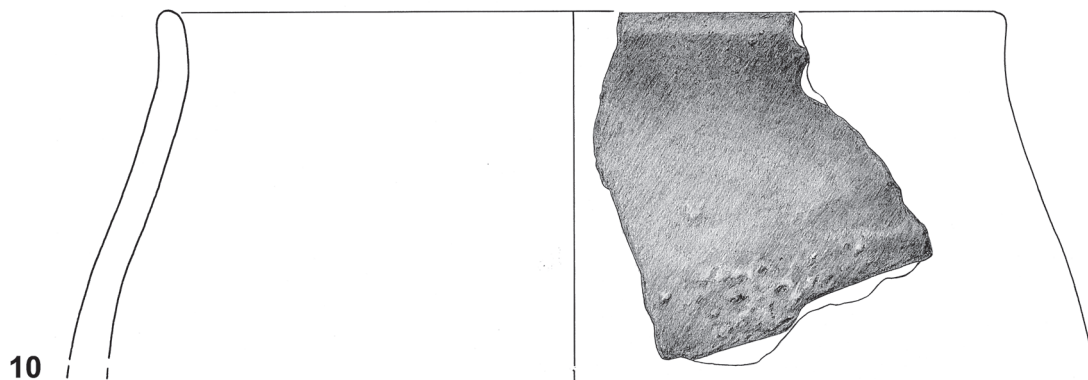
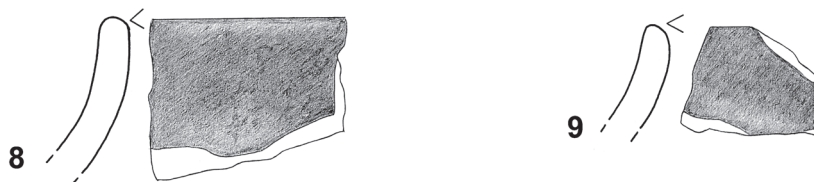
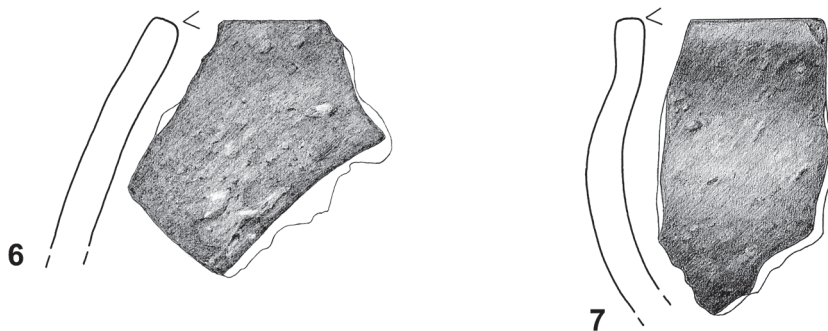
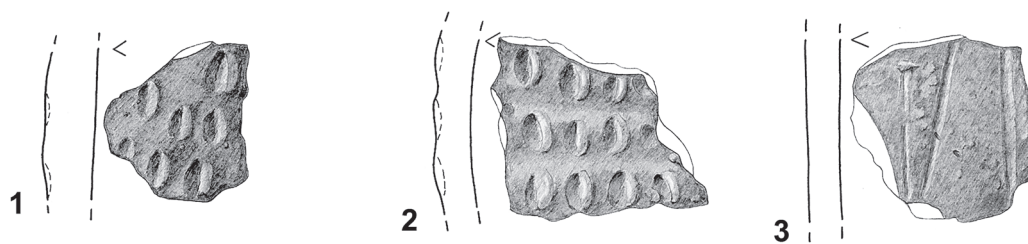

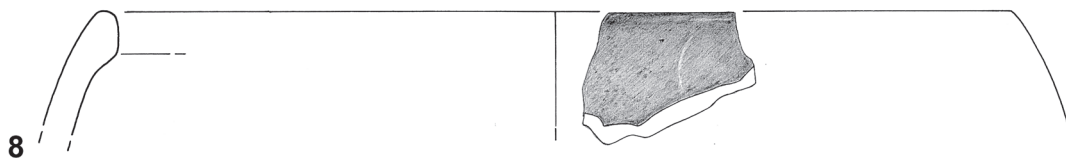
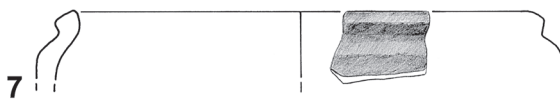
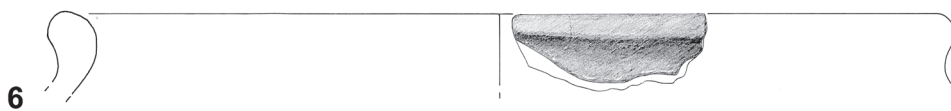
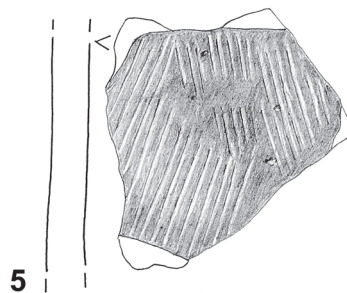
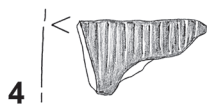
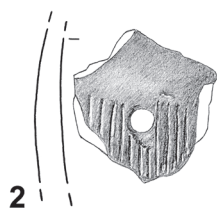
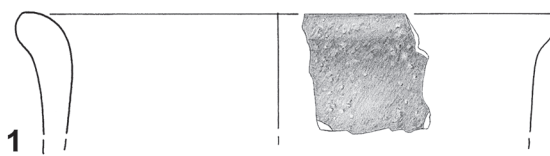

1: Katalognummer 1488; 2-3: Katalognummer 1493; 4-8: Katalognummer 1559. – M 1:2.

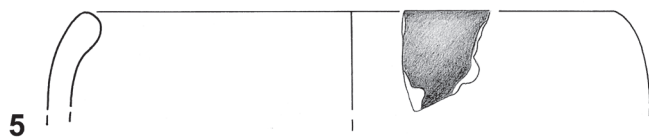
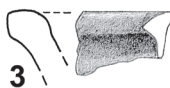
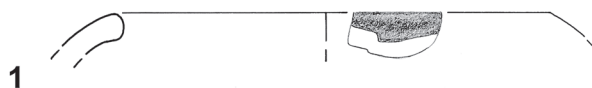

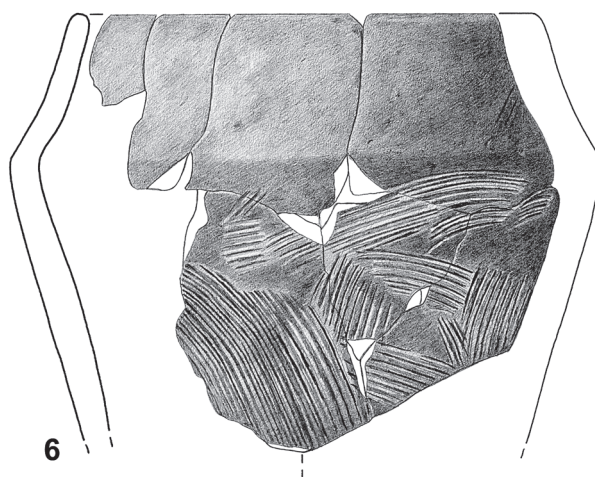
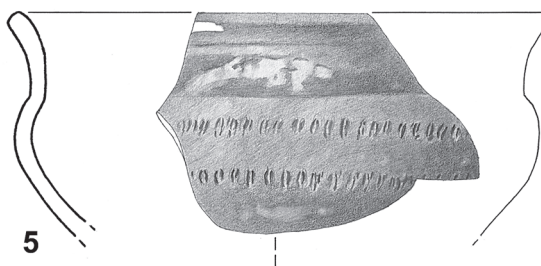
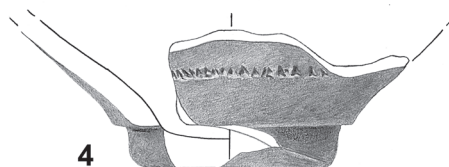
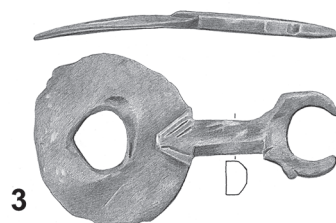
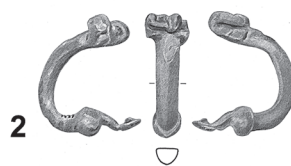
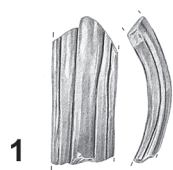

Lesefunde: 1: Glas; 2 und 3: Buntmetall; 4-6: Keramik. – M 1:2.

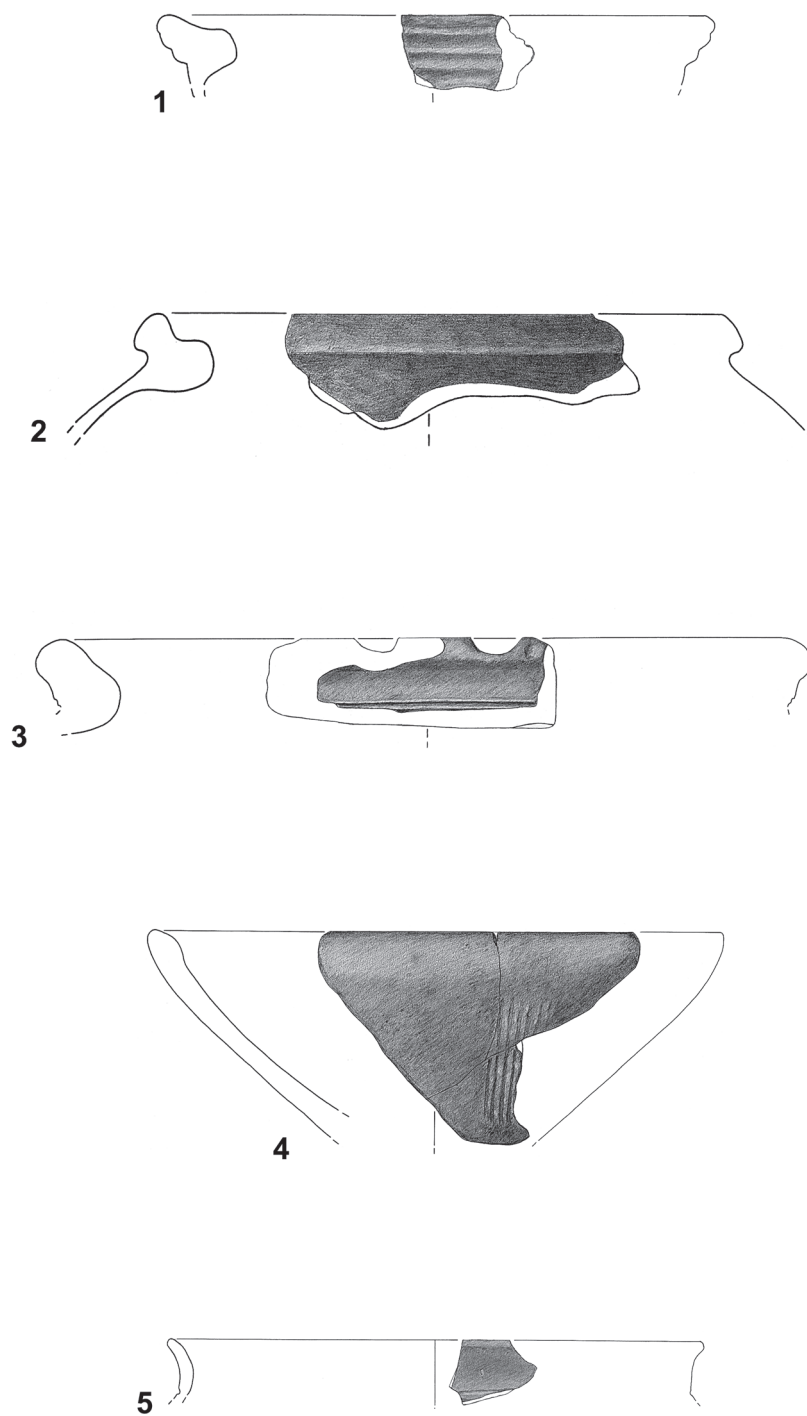

Römische und germanische Keramik aus mittelalterlichen Befunden. 1: Katalognummer 1740; 2: Katalognummer 1753; 3: Katalognummer 1129; 4: Katalognummer 1759; 5: Katalognummer 1754. – M 1:2.

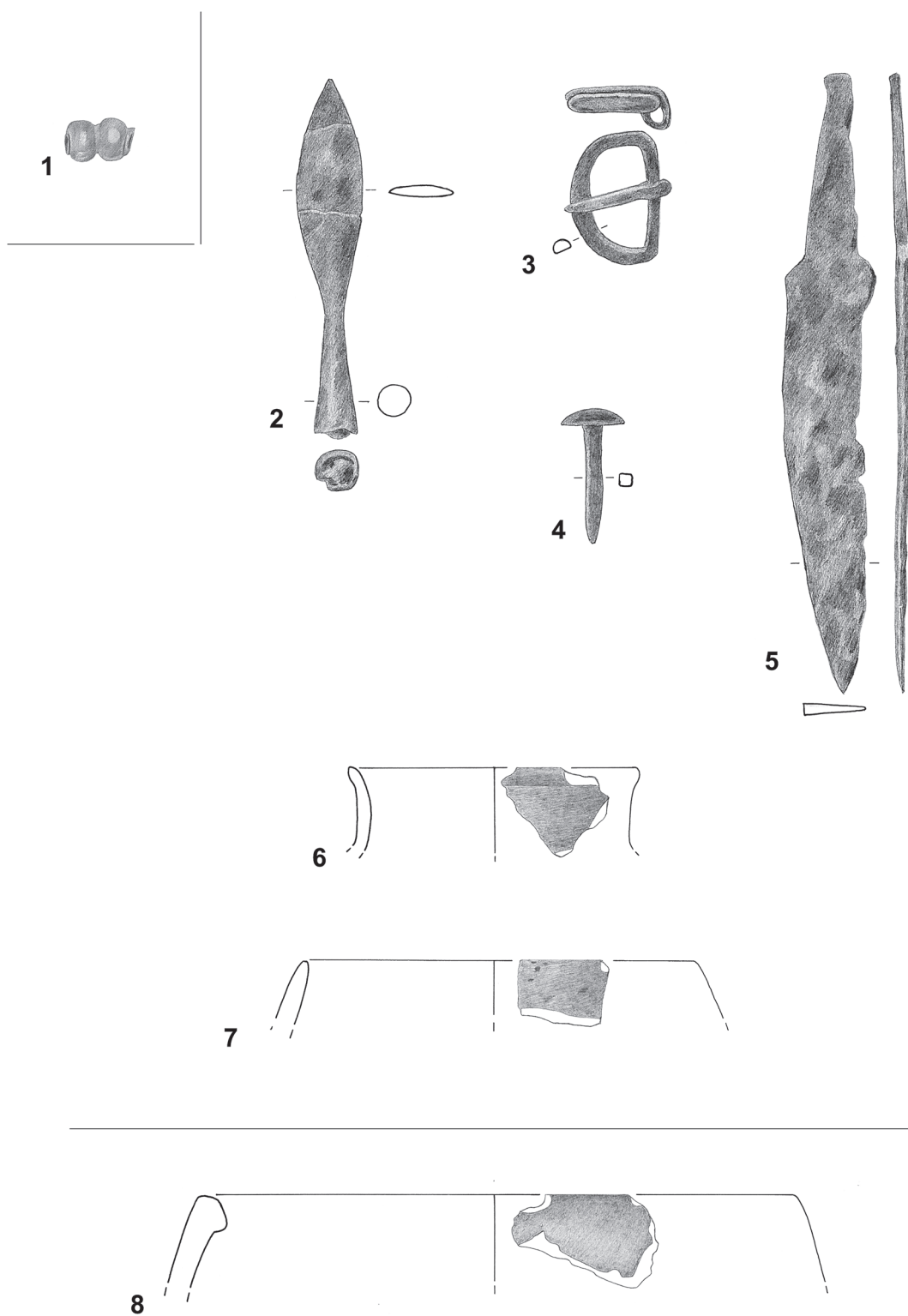

1: Katalognummer 334; 2-7: Katalognummer 376; 8: Katalognummer 380. – 1: Glas, M 1:1; 2-6: Eisen, M 1:2; 6-8: Keramik, M 1:2.

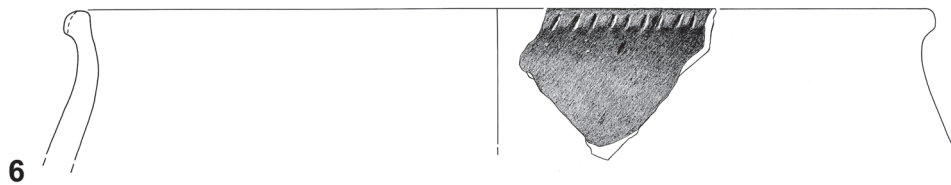
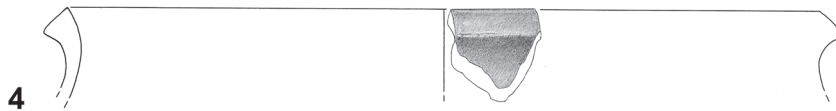
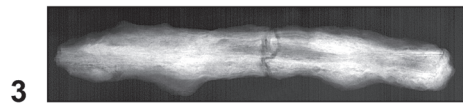
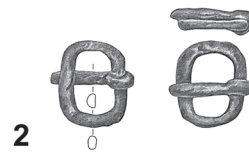
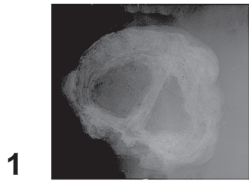

1: Katalognummer 381; 2–4 Katalognummer 382; 5: Katalognummer 385; 6: Katalognummer 387. –
1–3 und 5: Eisen, M 1:2; 4 und 6: Keramik, M 1:3.

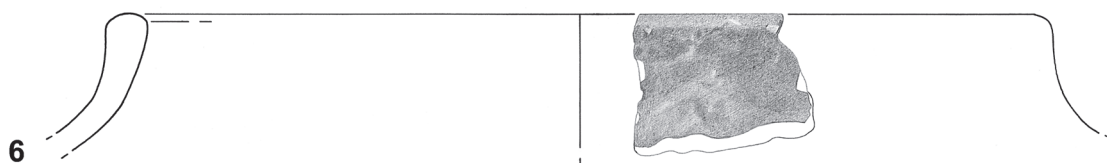
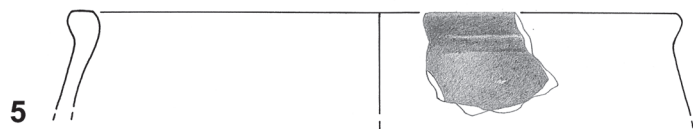
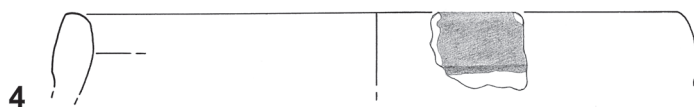
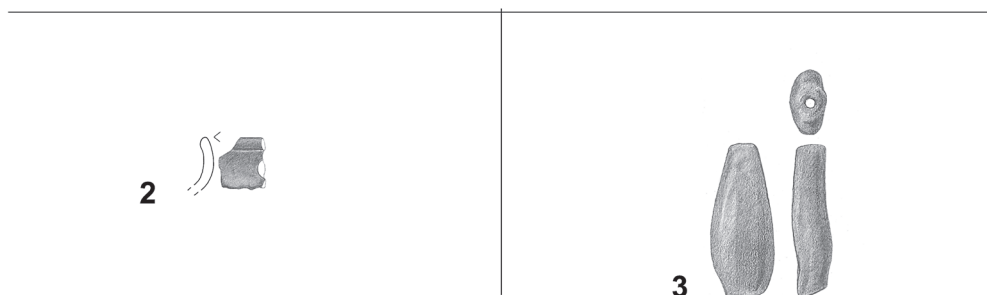
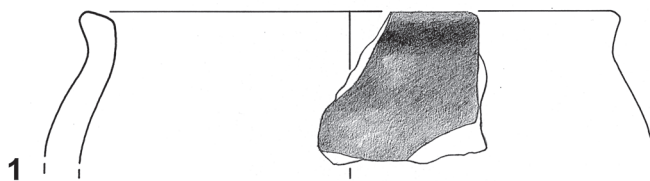

1: Katalognummer 392; 2: Katalognummer 391; 3–6: Katalognummer 394. – 1, 2, 4–6: Keramik, M 1:2; 3: Glas, M 1:1.

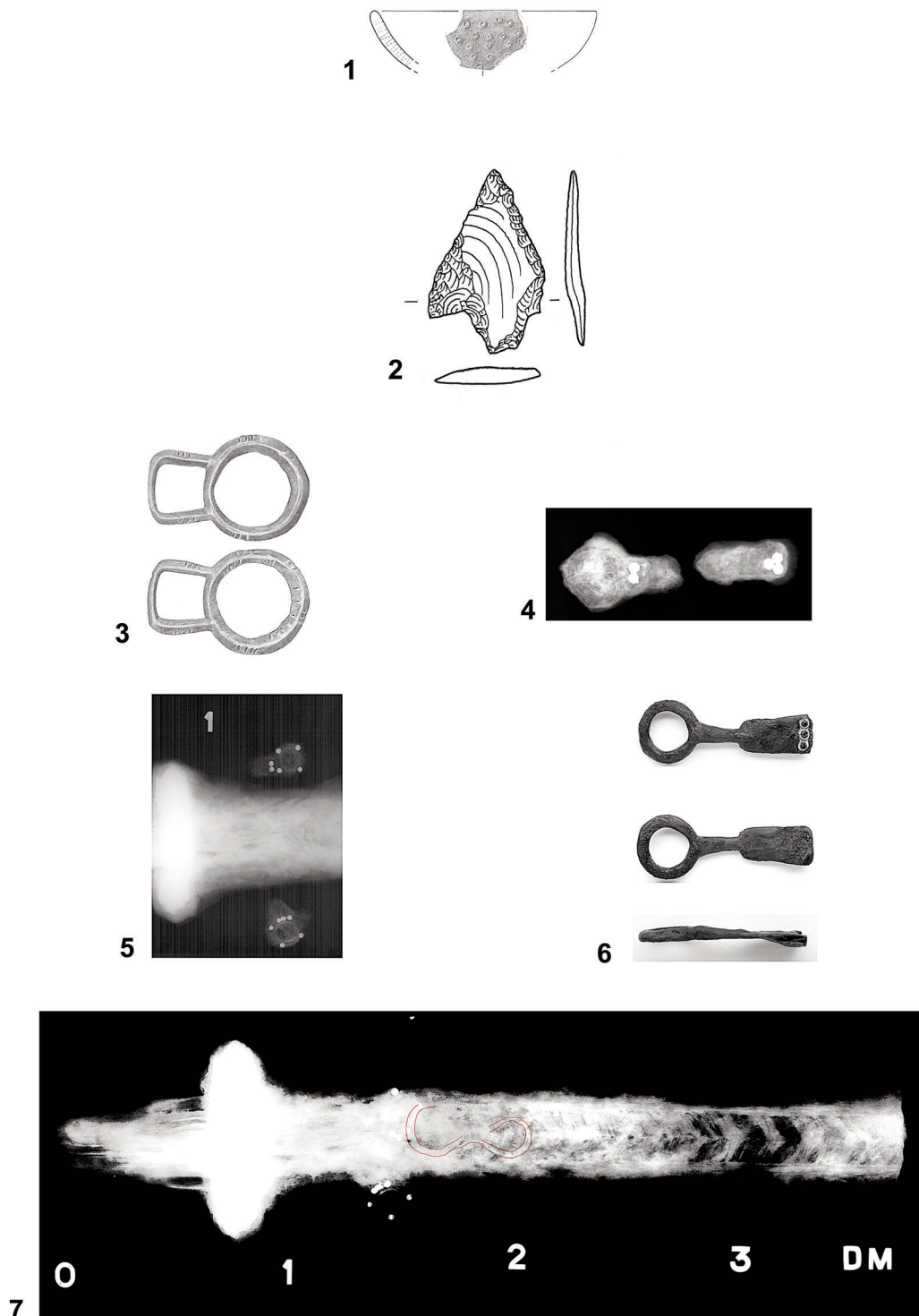

Katalognummer 399: 1: Keramik, M 1:2; 2: Feuerstein, M 1:1; 3: Buntmetall, M 1:2; 4: Eisen und Silber, M 1:2; 5 und 6: Eisen und Silber, M ca. 1:3.

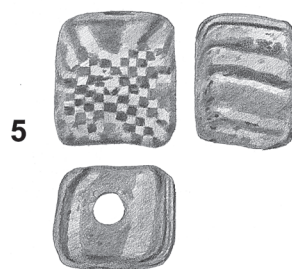
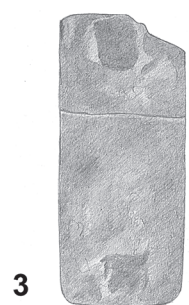
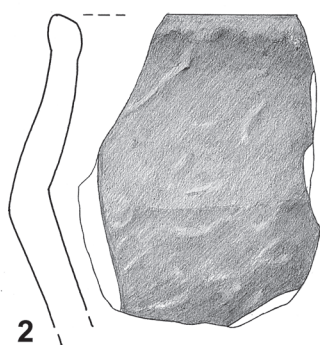
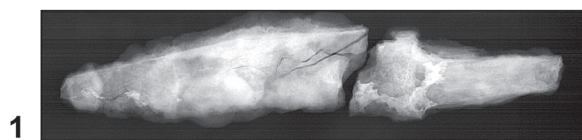

1 und 2: Katalognummer 500. 3–5: Katalognummer 606. 1: Eisen, M 1:2. 2: Keramik, M 1:2. 3: Silber, M 1:1.
4 und 5: Glas, M 1:1.

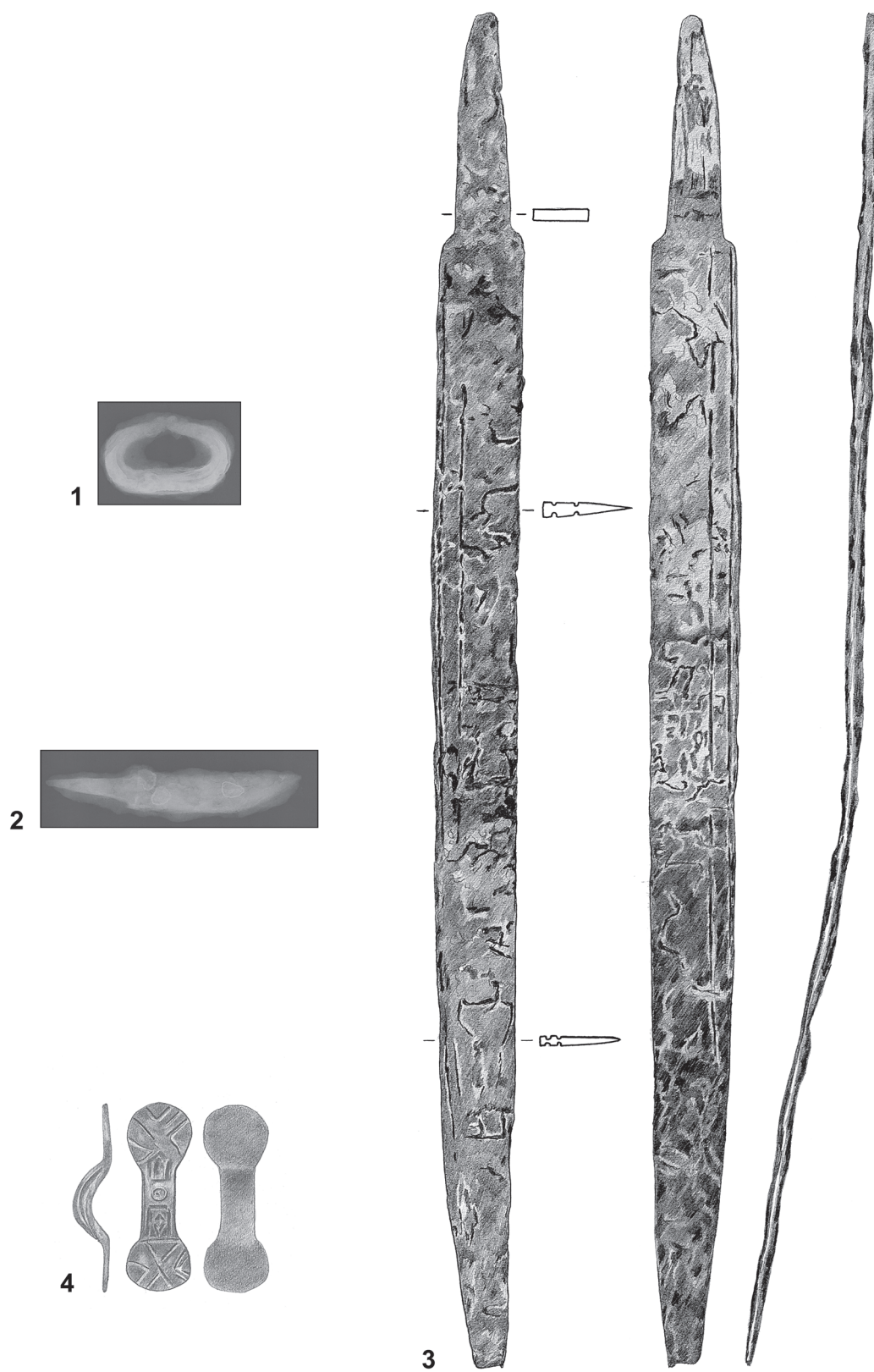

Lesefunde: 1-3: Eisen; 4: Silber. – 1 und 2: M 1:3; 3: M 1:4; 4: M 1:1.

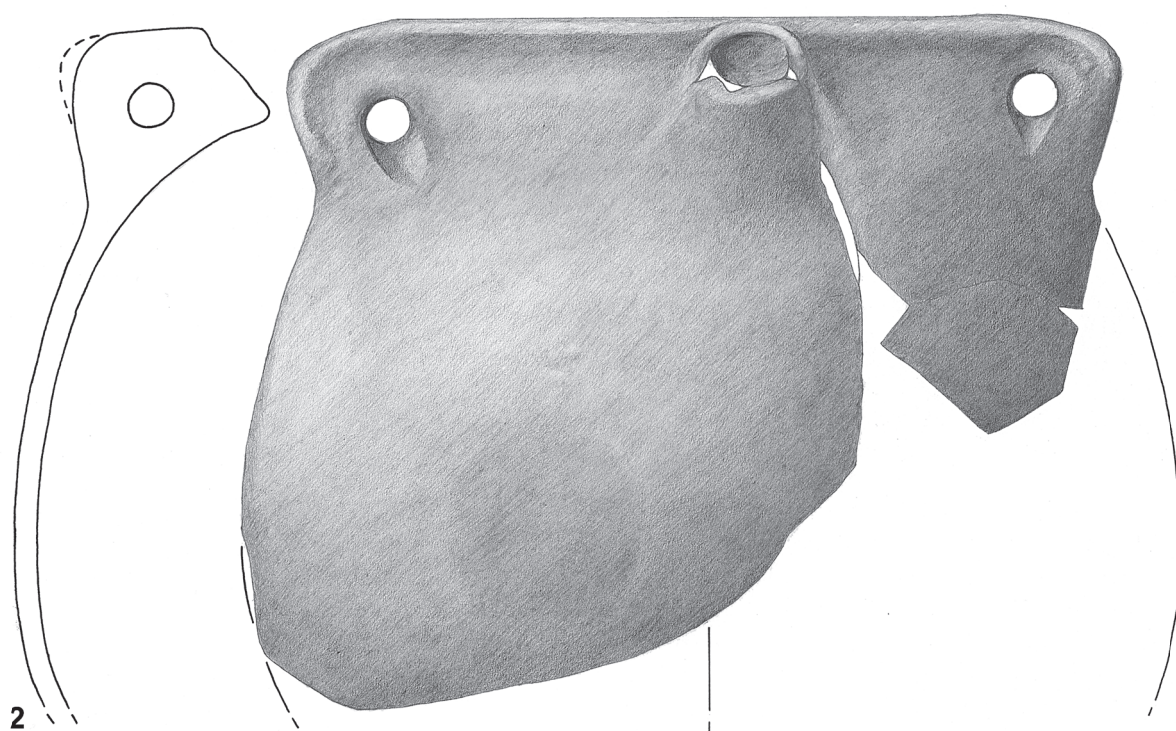
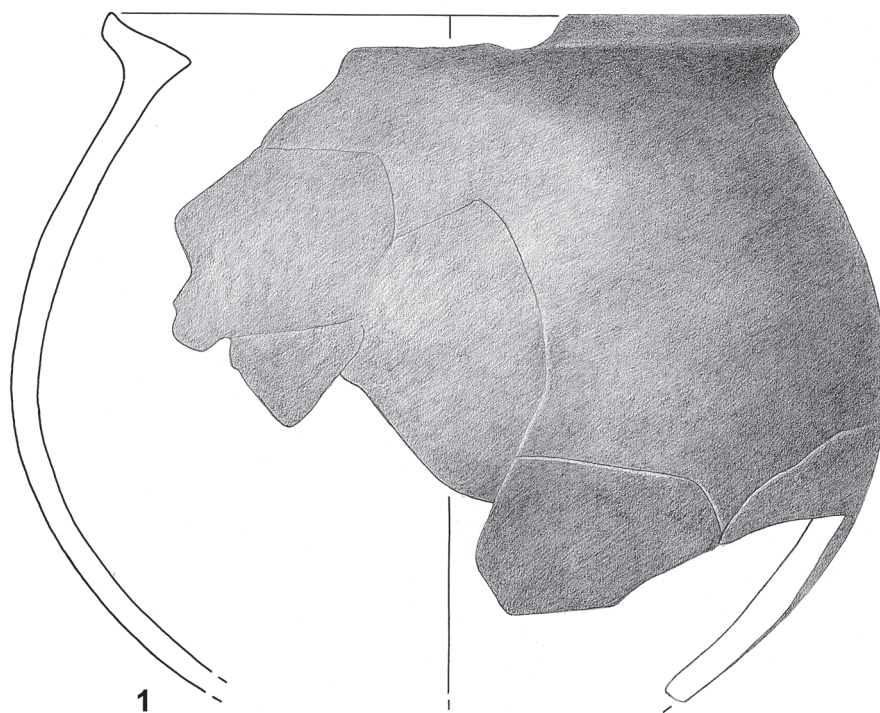

Warenart 01. 1: Katalognummer 1283; 2: Katalognummer 1738. – M 1:2.

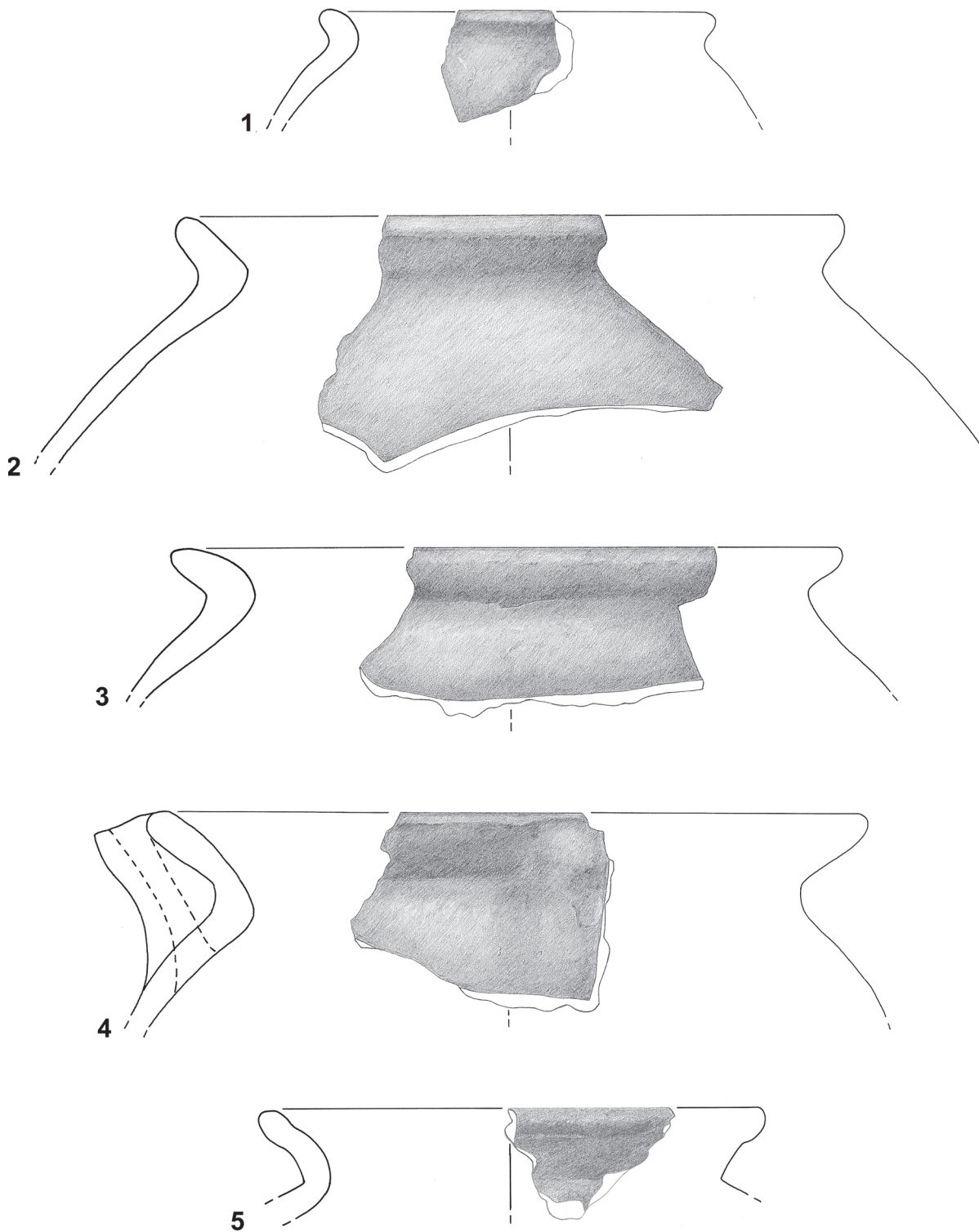

Warenart 01. 1–3: Randform 101a; 4 und 5: Randform 101b. – 1, 2 und 4: Katalognummer 1283; 3: Katalognummer 1311; 4: Katalognummer 1705. – M 1:2.

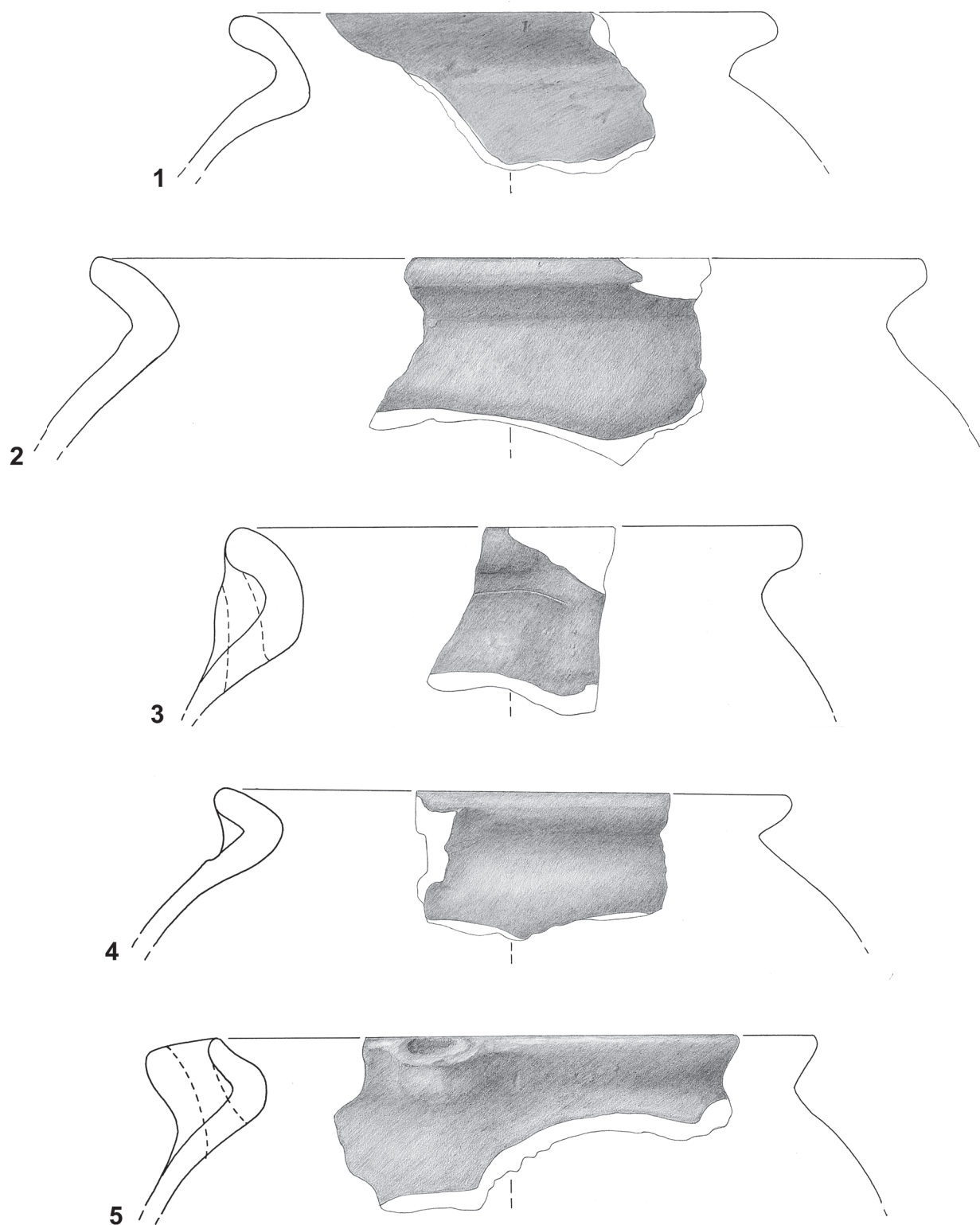

Warenart 01. Randform 101. – 1: Katalognummer 1729; 2: Katalognummer 1329; 3 und 5: Katalognummer 1283; 4: Katalognummer 1332. – M 1:2.

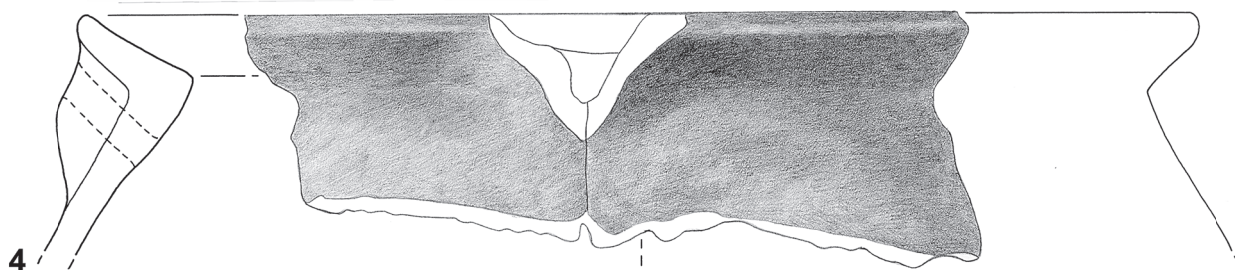
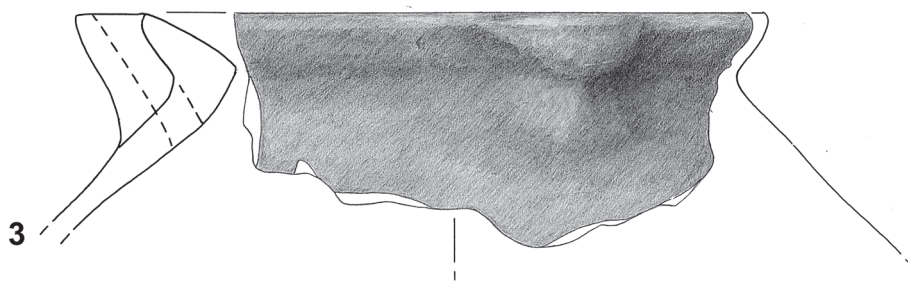
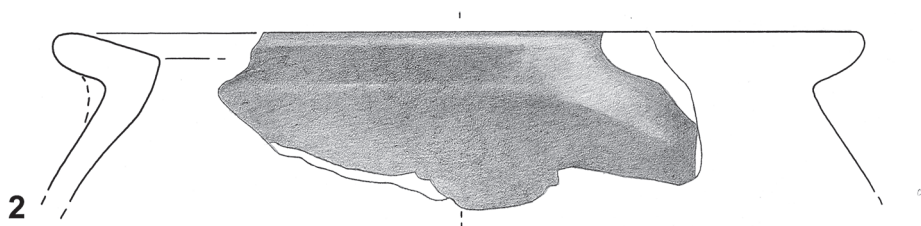
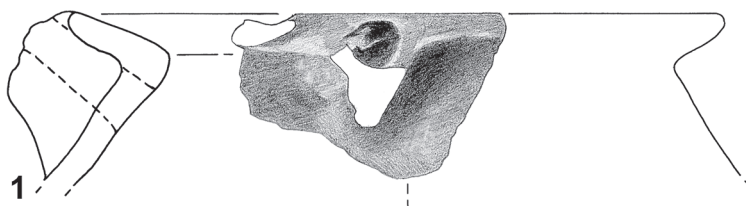

Warenart 01. Randform 102. – Katalognummer 1283. – M 1:2.

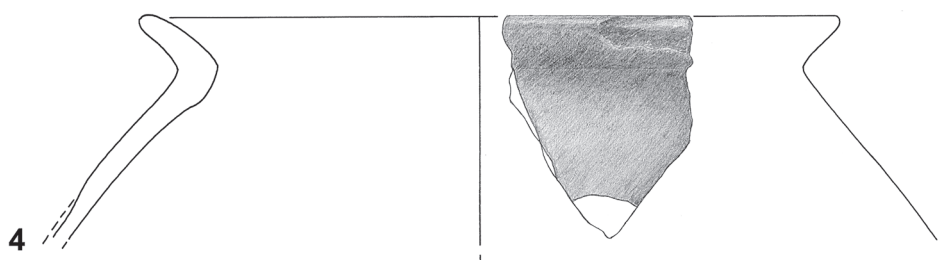
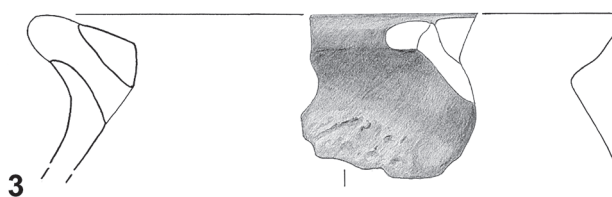
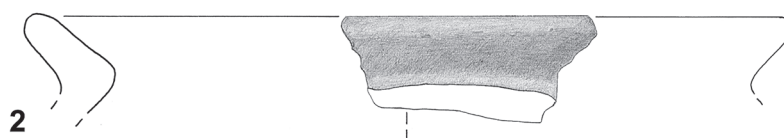
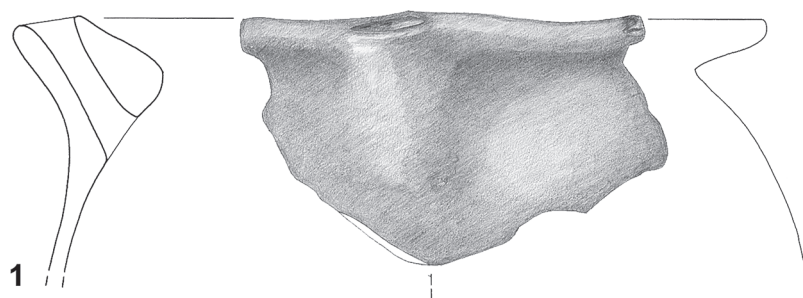

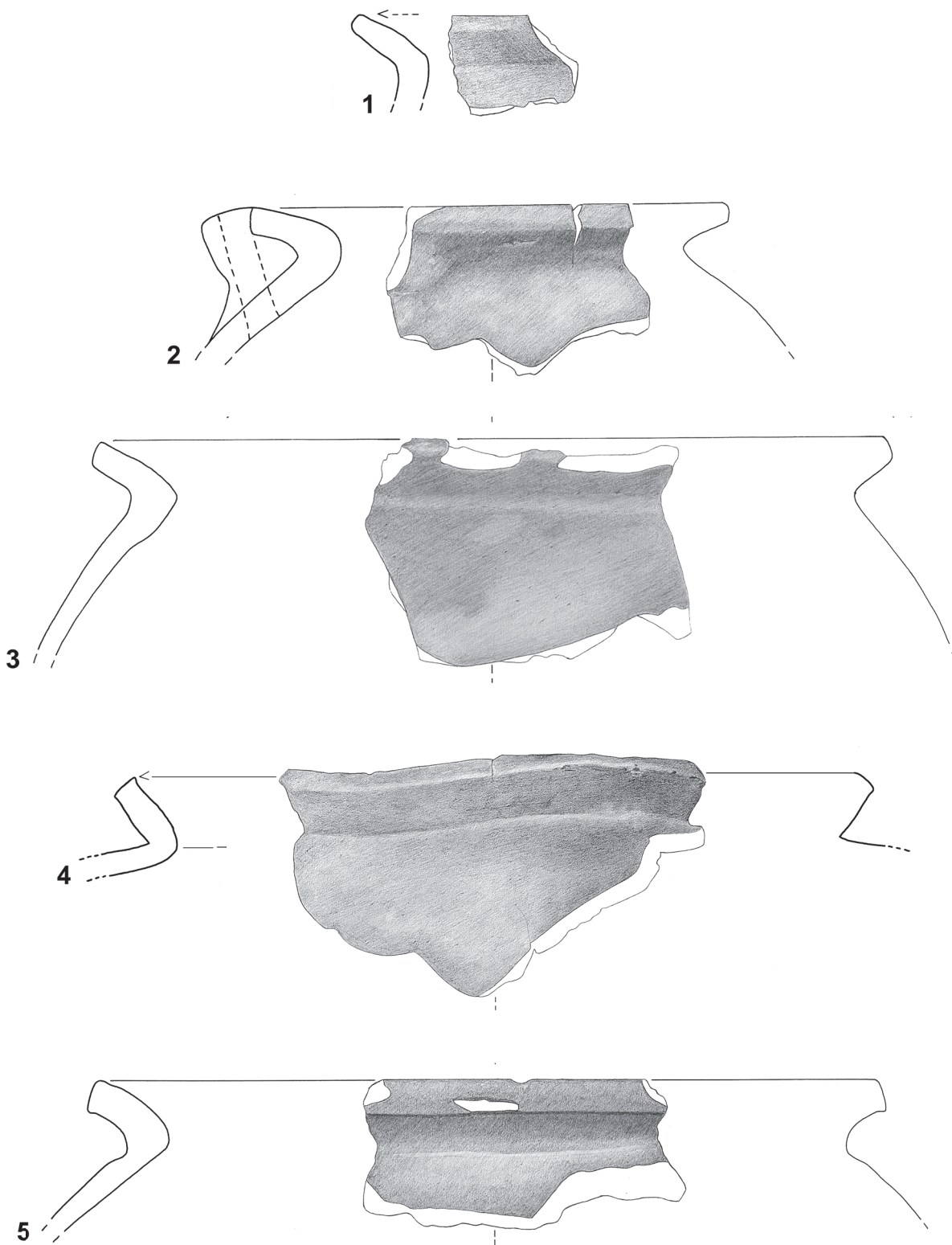

Warenart 01. Randform 103. – 1: Katalognummer 1753; 2 und 4: Katalognummer 1283; 3: Katalognummer 1729; 5: Katalognummer 1311. – 5: M 1:3; alle anderen M 1:2.

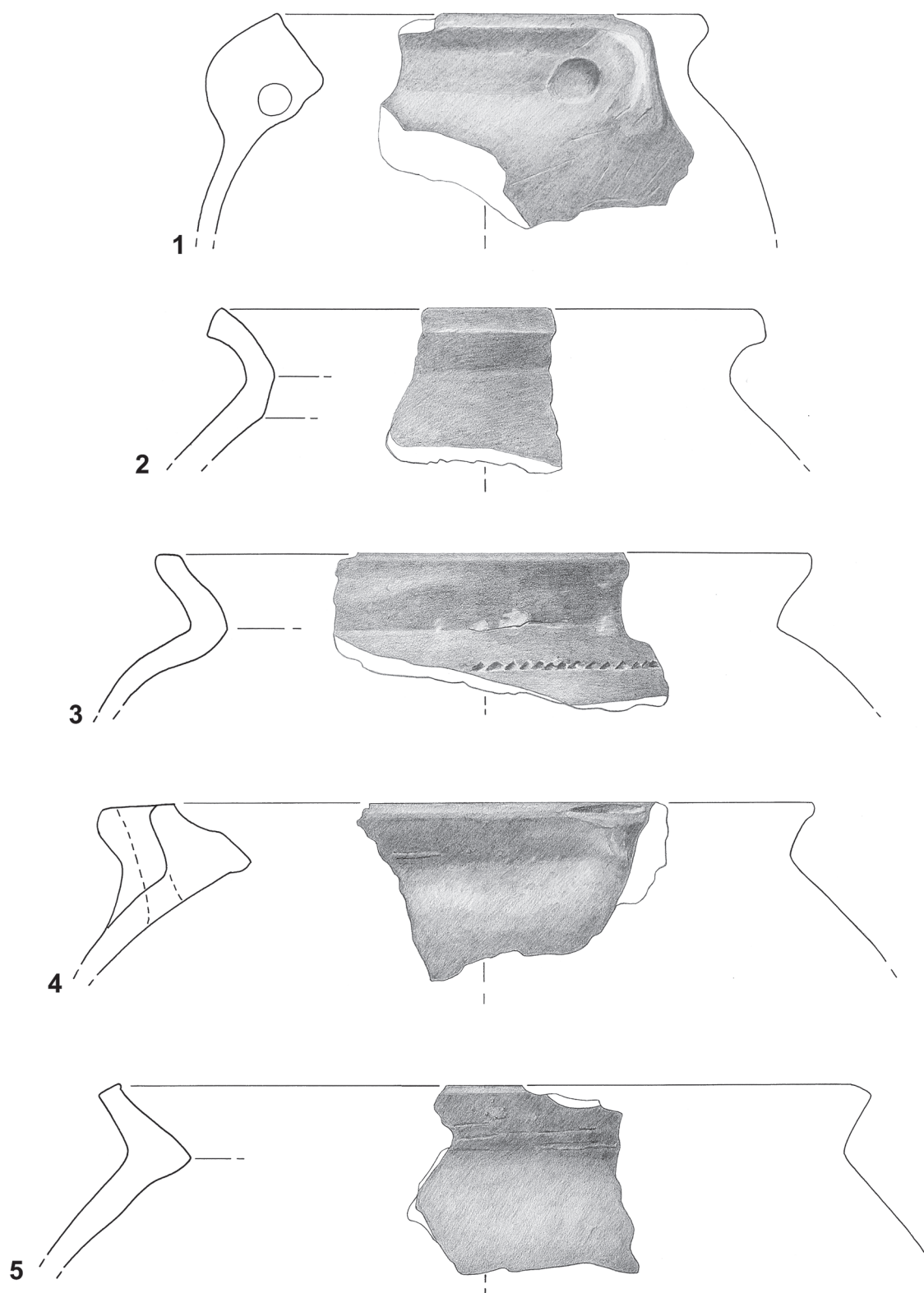

Warenart 01. Randform 103. – 1: Katalognummer 1753; 2 und 4: Katalognummer 1283; 3: Katalognummer 1729; 5: Katalognummer 1311. – 5: M 1:3; alle anderen: M 1:2.

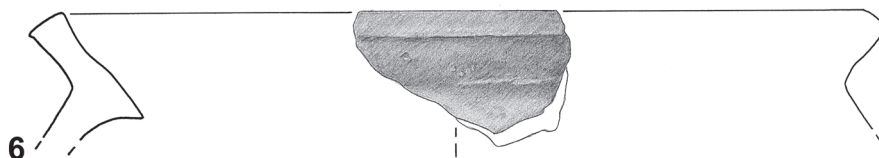
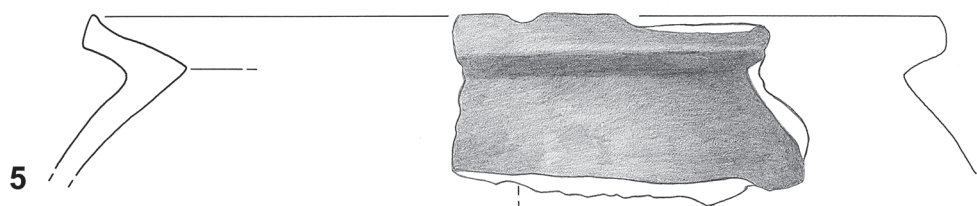
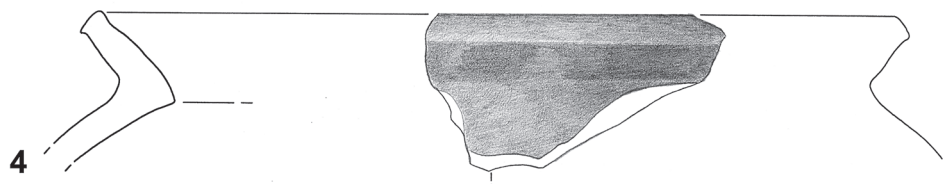
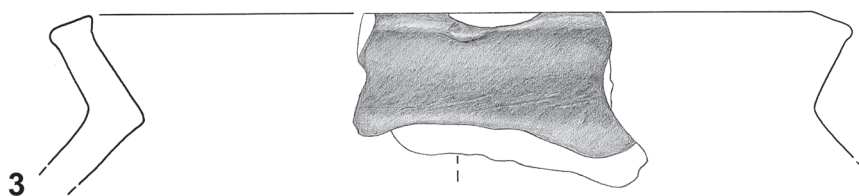
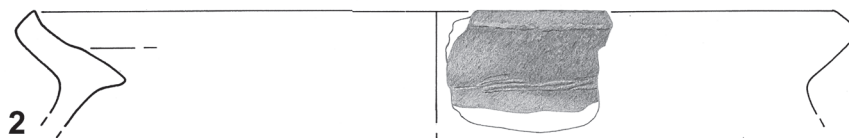

Warenart 01. Randform 104. – 1: Katalognummer 1753; 2–5: Katalognummer 1283. – M 1:2.

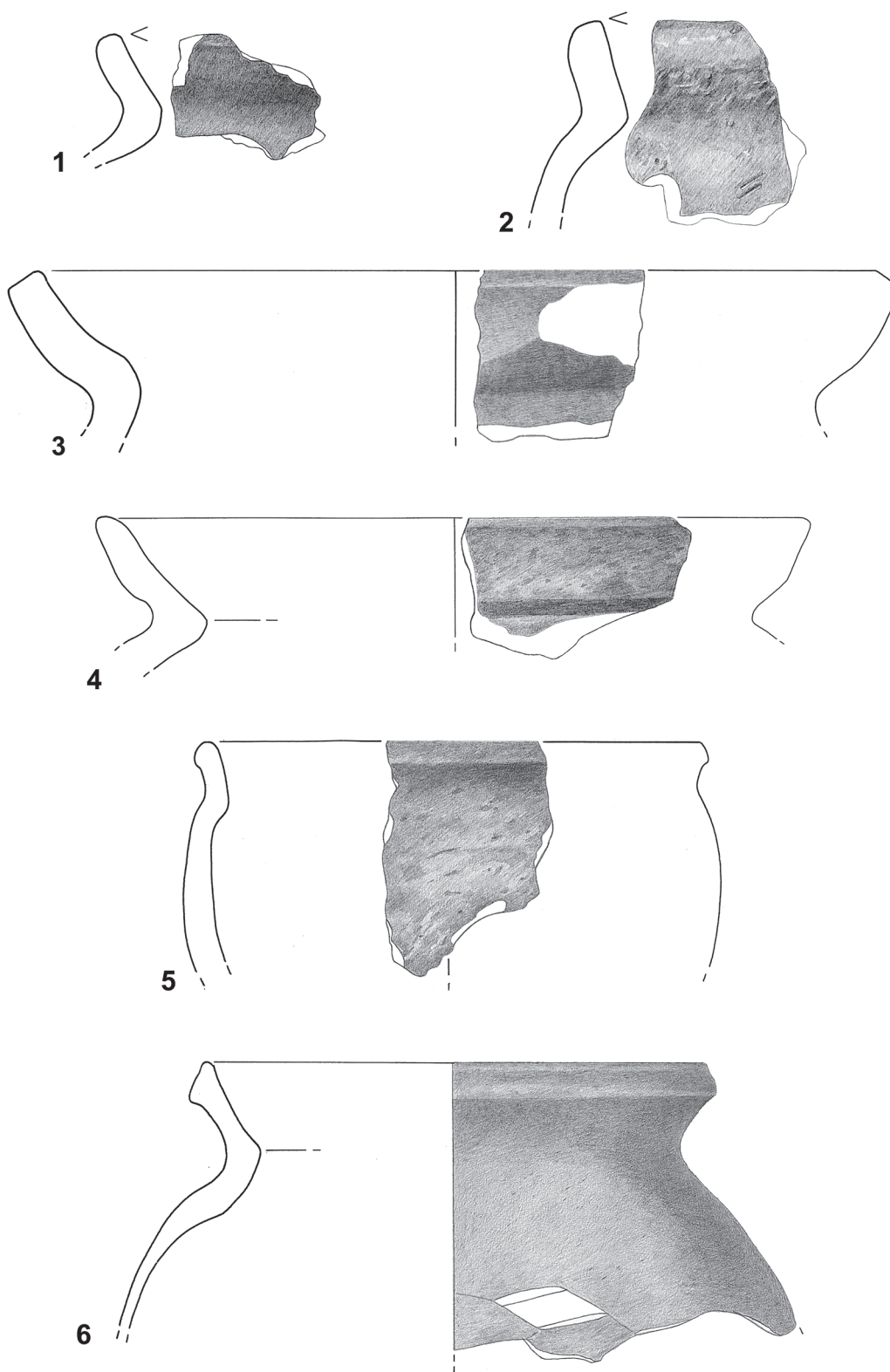

Warenart 01. 1, 3 und 5: Randform 105; 6: Randform 106. – 1: Katalognummer 1448; 2: Katalognummer 1585; 3: Katalognummer 1806; 4: Katalognummer 1108; 5: Katalognummer 1332; 6: Katalognummer 1283. – M 1:2.

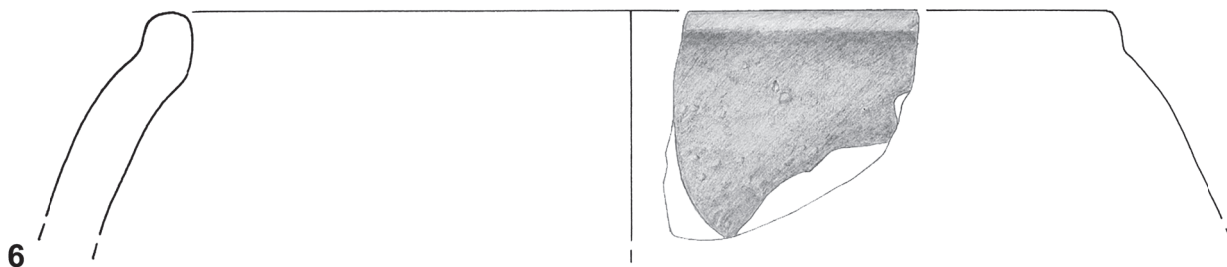
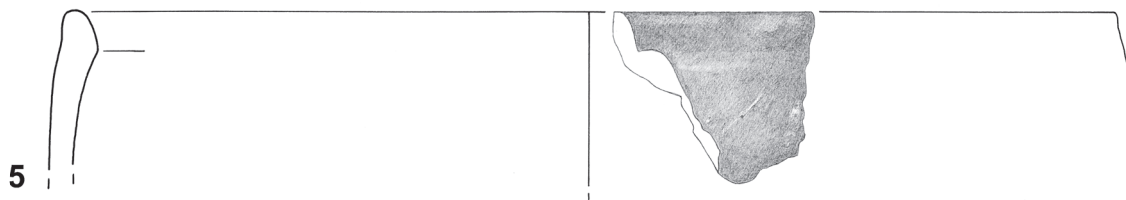
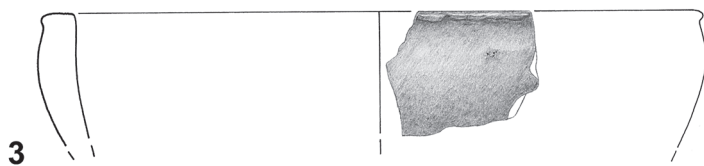
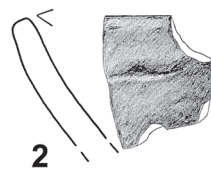
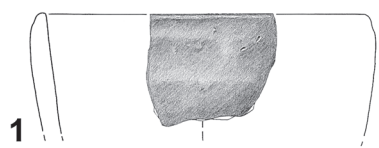

Warenart 01. 1–3: Randform 109c; 4–6: Randform 109b. – 1: Katalognummer 1902; 2: Katalognummer 751; 3: Katalognummer 1293; 4: Katalognummer 1307; 5: Katalognummer 1289. – M 1:2.

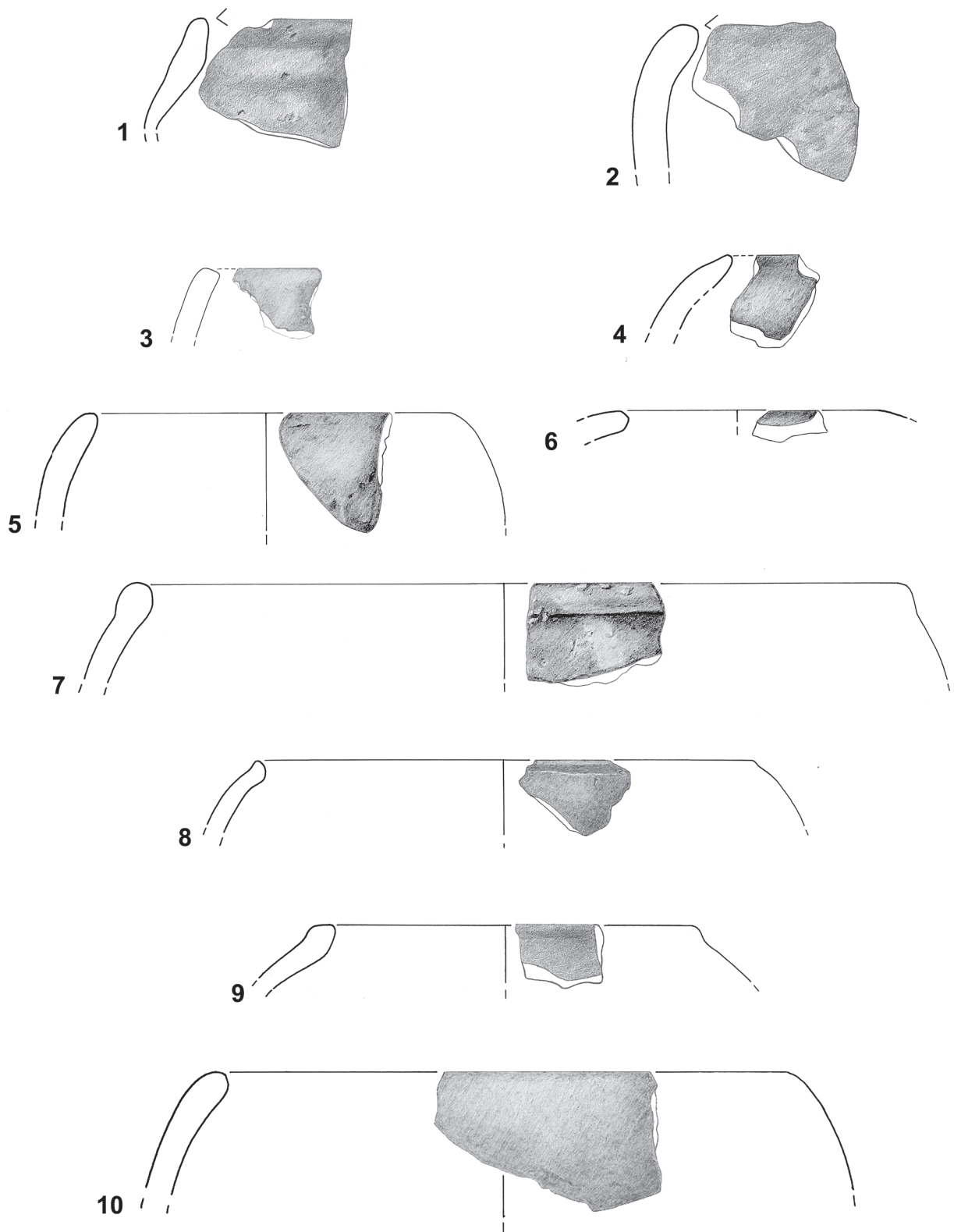

Warenart 01. Randform 109a. – 1 und 2: Katalognummer 1283; 3: Katalognummer 1850; 4–8: Katalognummer 1129; 9: Katalognummer 1338; 10: Katalognummer 1752. – M 1:2.

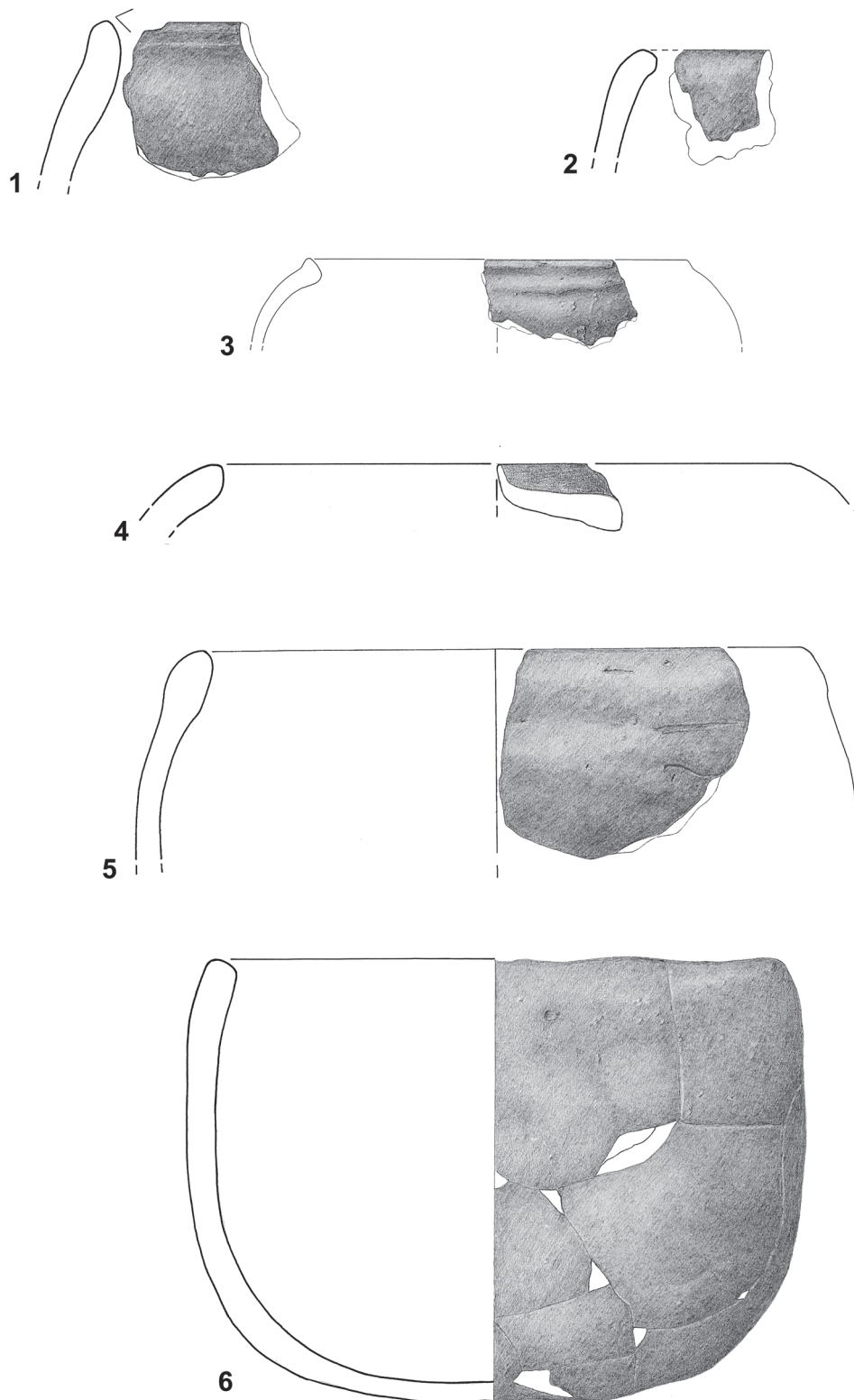

Warenart 01. Randform 109a. – 4: Katalognummer 1293; alle anderen: Katalognummer 1243. –
3: M 1:3; alle anderen: M 1:2.

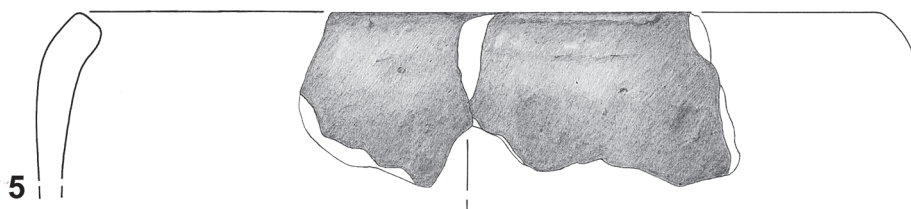
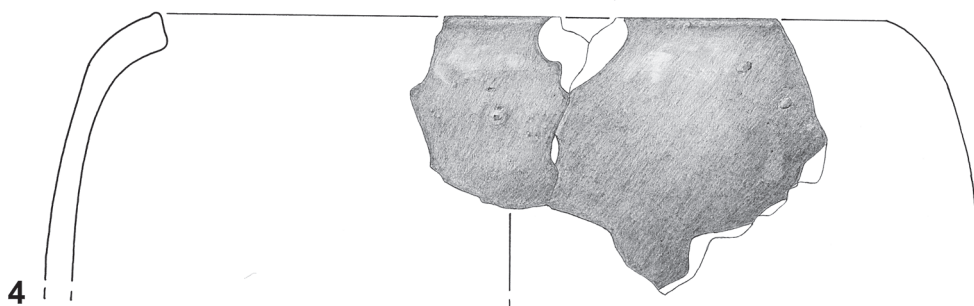
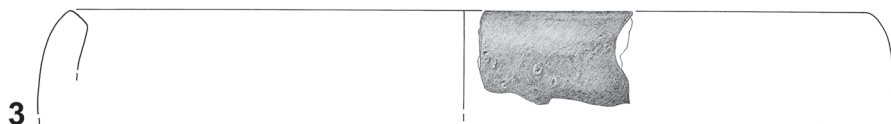
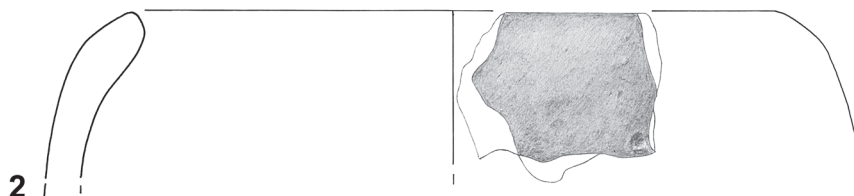
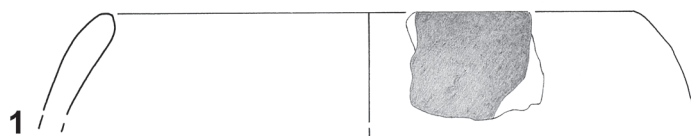

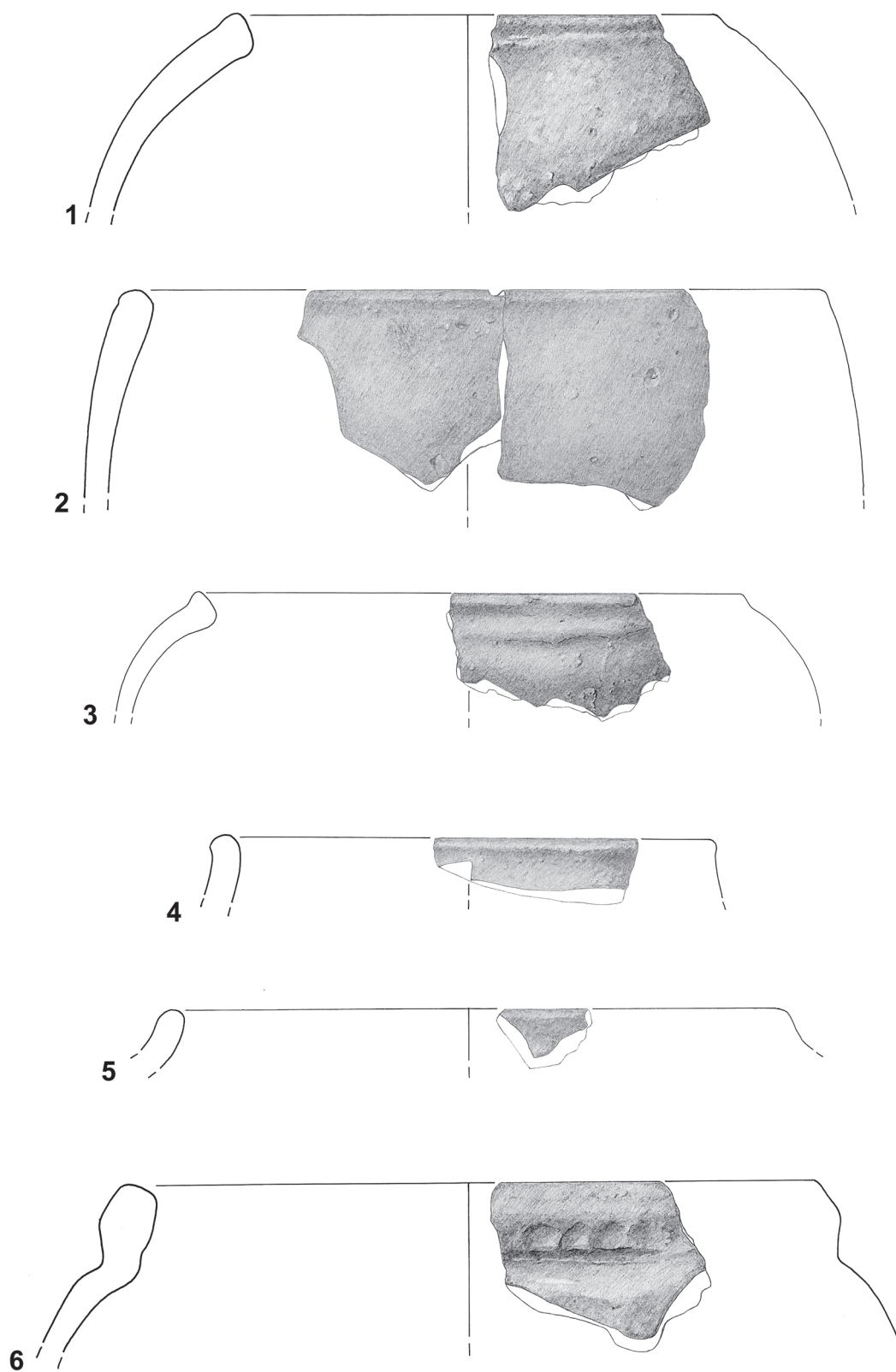

Warenart 01. 1–3: Randform 109a; 4–6: Randform 109b. – Katalognummer 1243. – 3: M 1:3; alle anderen: M 1:2.

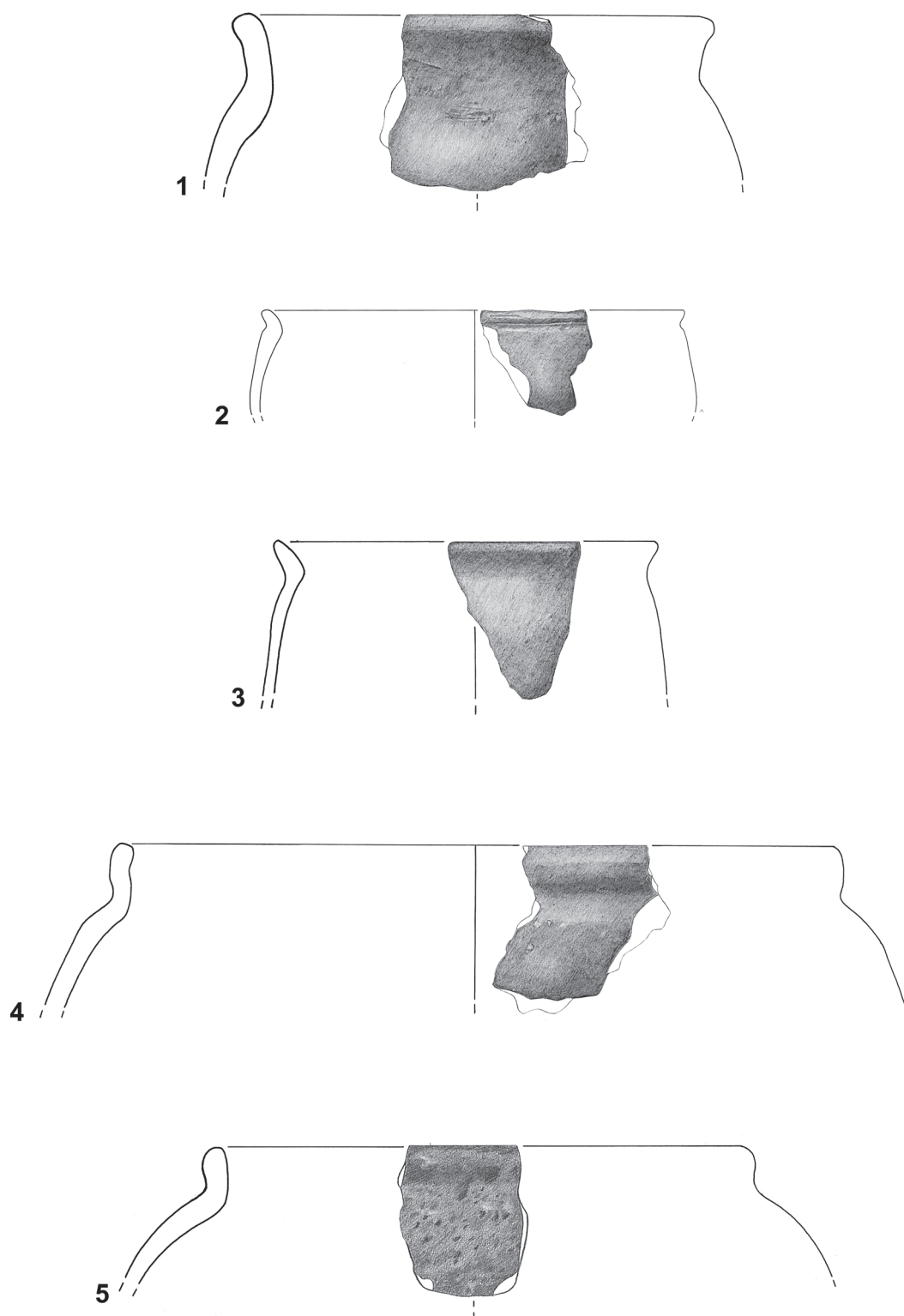

Warenart 01. Randform 109b. – 1: Katalognummer 1015; 2: Katalognummer 1850; 3: Katalognummer 1753; 4: Katalognummer 1176; 5: Katalognummer 743. – M 1:2.

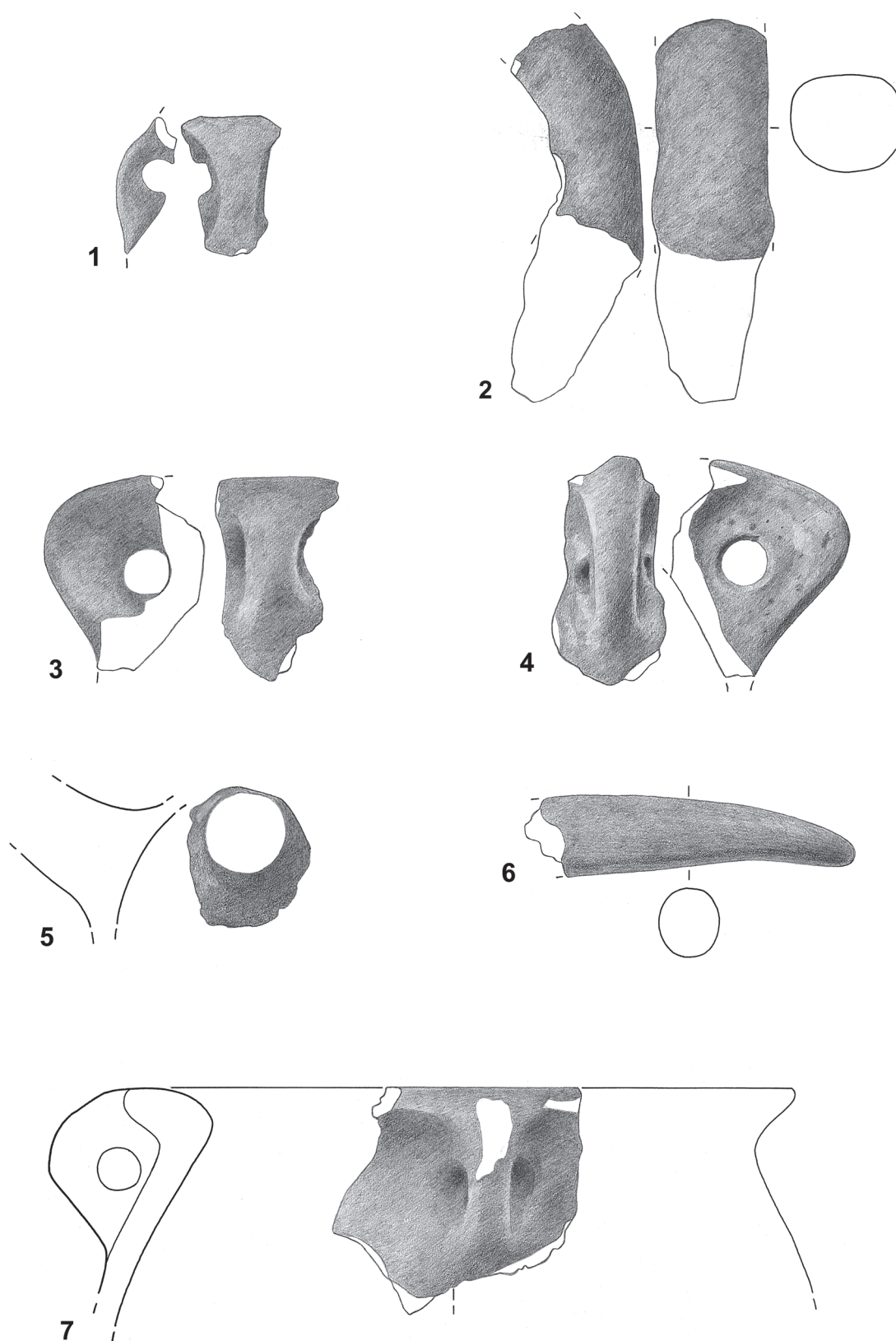

Warenart 01. 1: Katalognummer 1738; 2, 3 und 7: Katalognummer 1753; 4-6: Katalognummer 1283. – M 1:2.

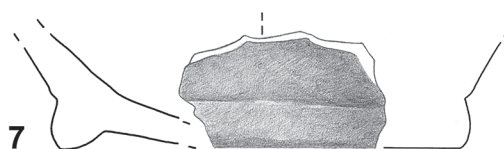
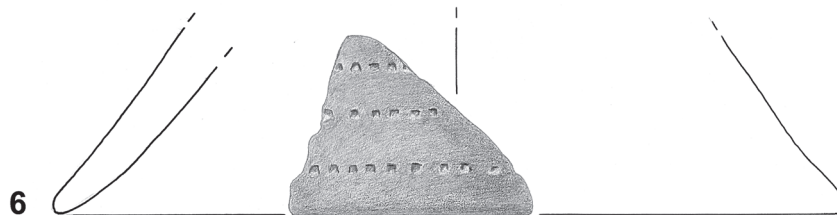
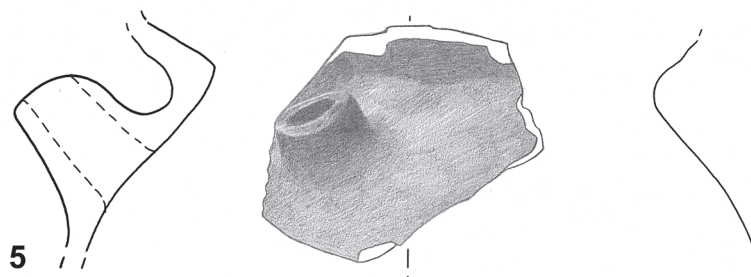
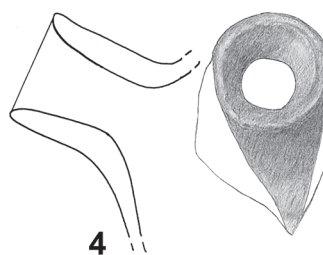
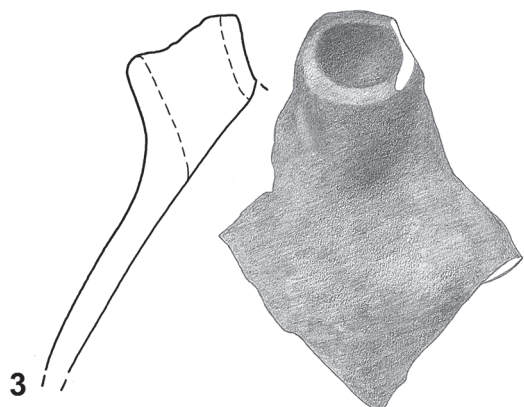
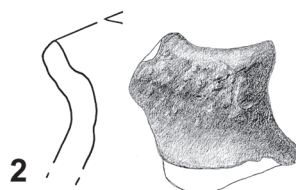
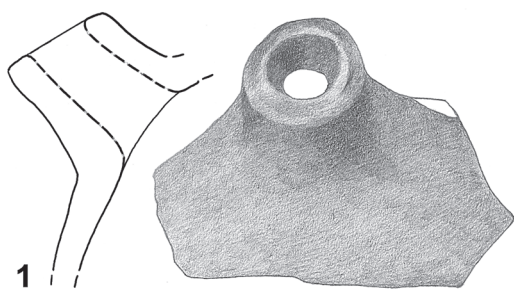

Warenart 01. 1, 3 und 7: Katalognummer 1283; 2: Katalognummer 1335; 4: Katalognummer 2069;
5: Katalognummer 1738; 6: Katalognummer 1753. – M 1:2.

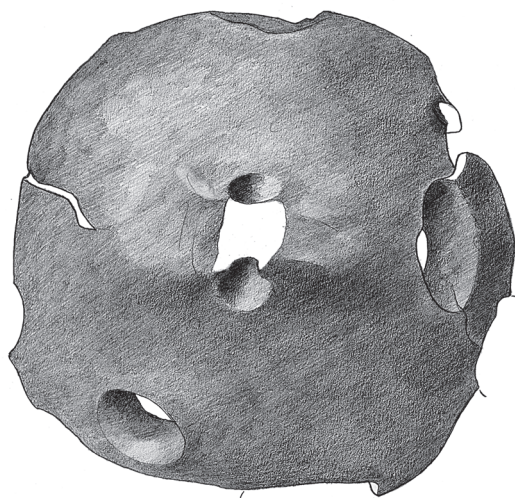
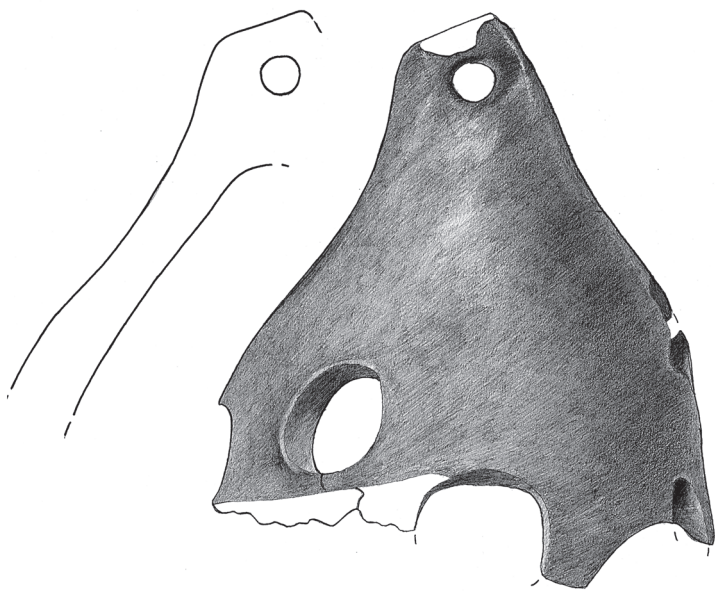

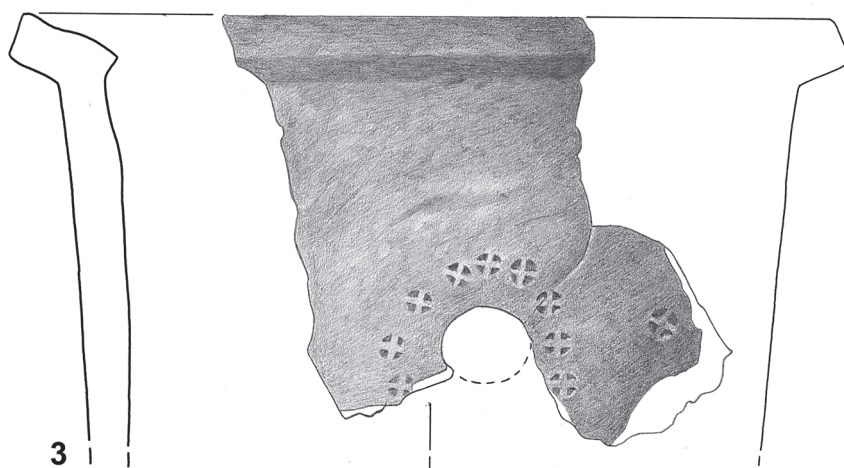
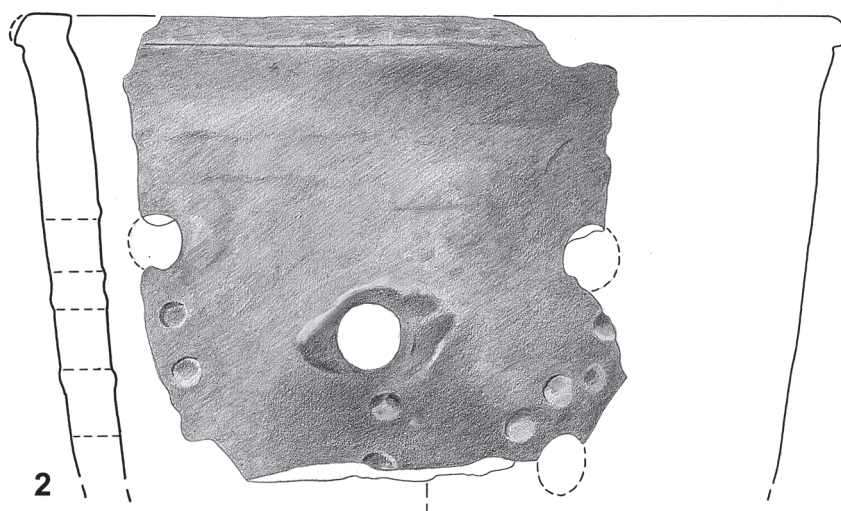
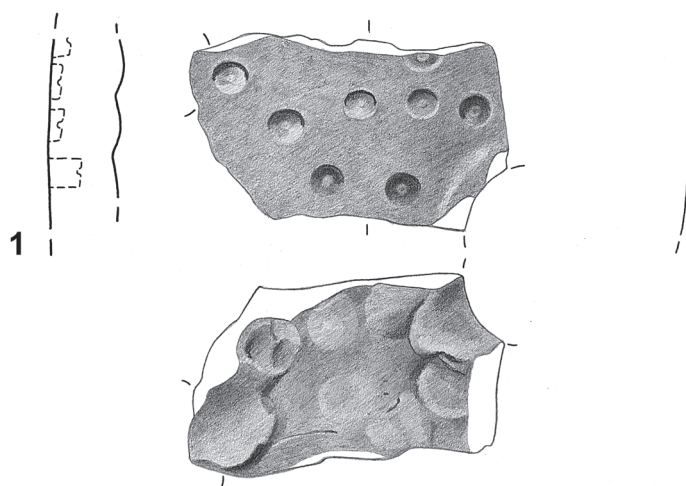

Warenart 01. Katalognummer 1283. – M 1:2.

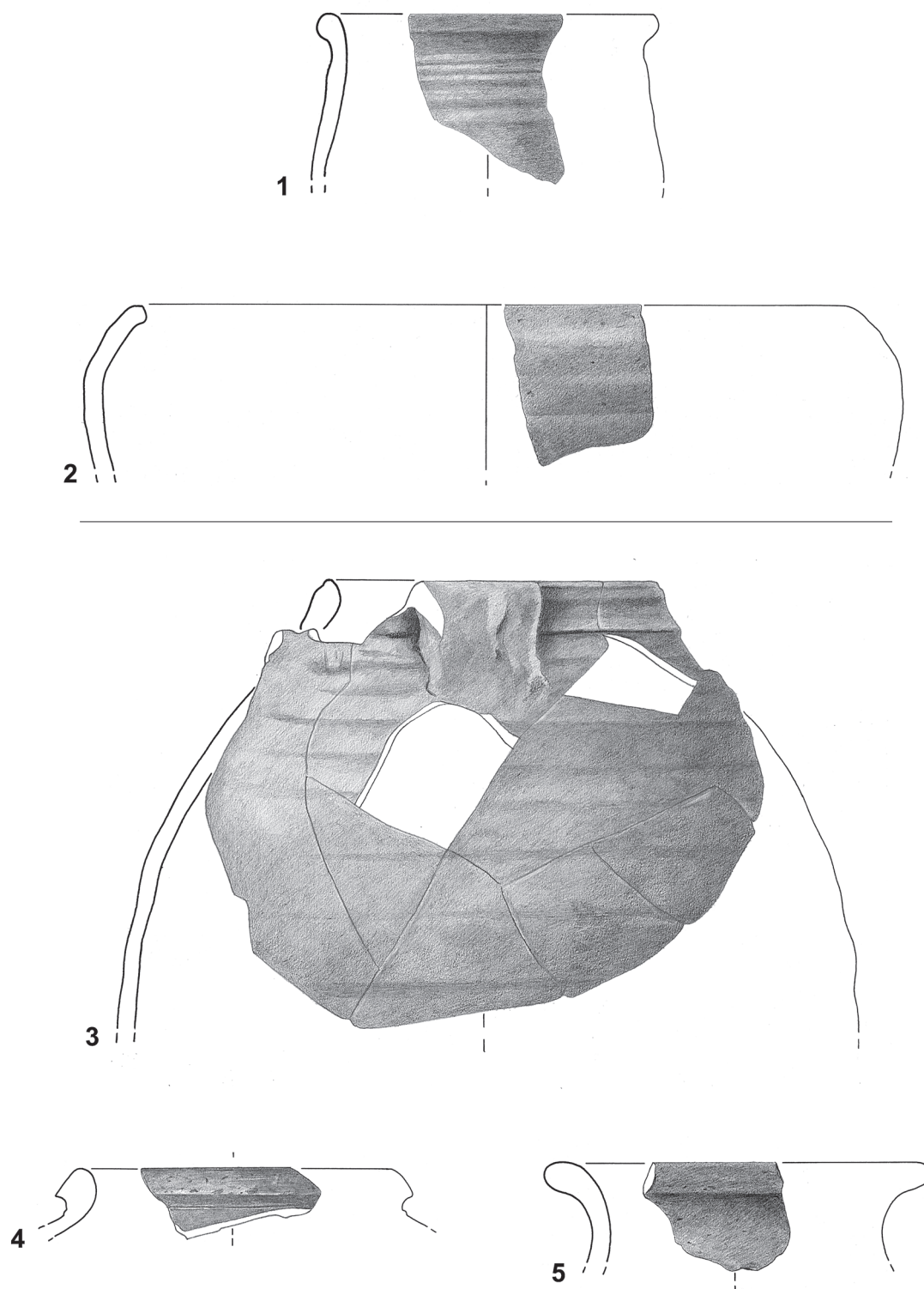

1 und 2: Warenart 02; 5–7: Warenart 03. – 1: Katalognummer 1326; 2: Katalognummer 1243; 3 und 5: Katalognummer 1283; 4: Katalognummer 1329. – M 1:2.

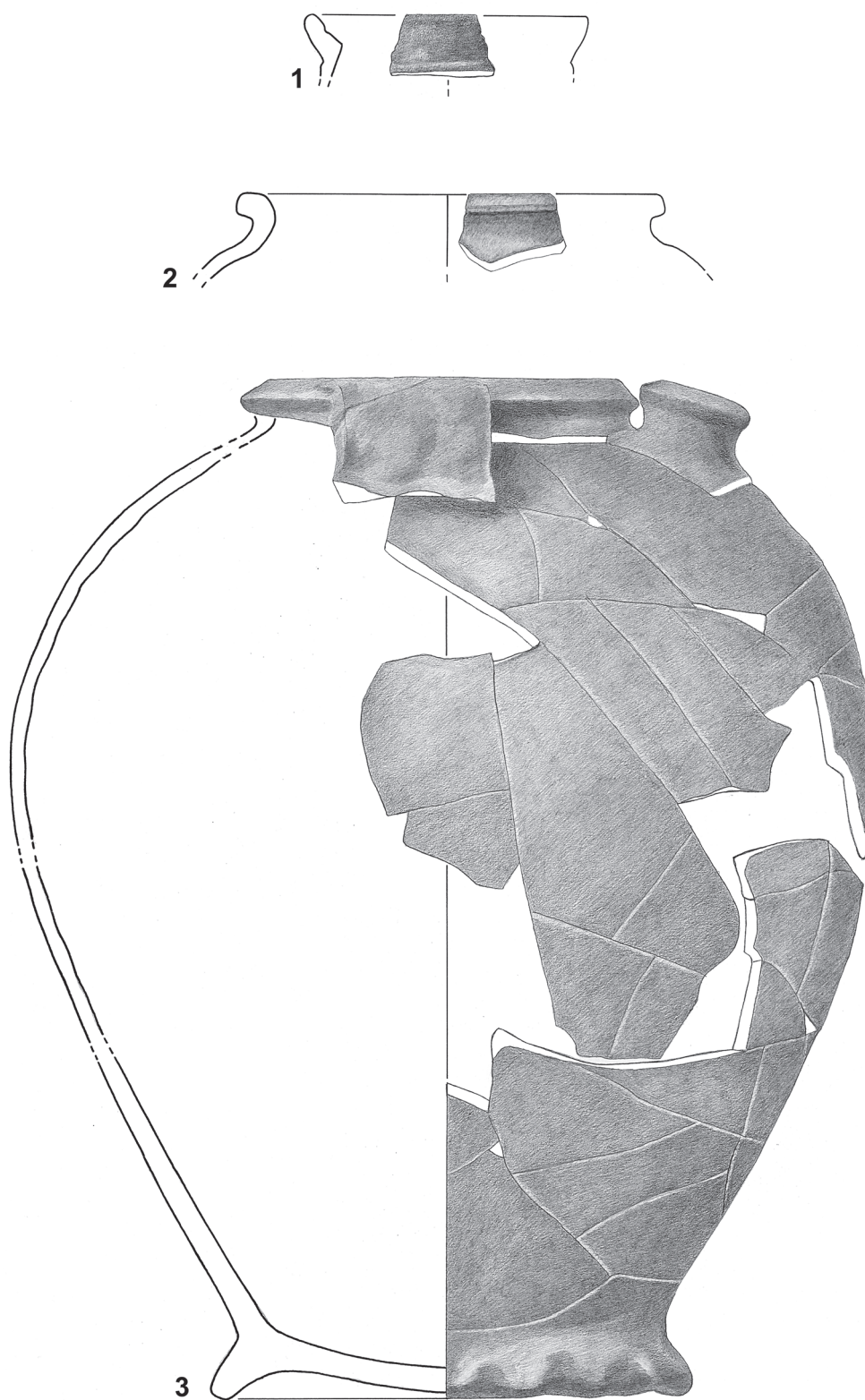

Warenart 04. 1: Katalognummer 1283; 2: Katalognummer 1273; 3: Katalognummer 1738. – M 1:2.

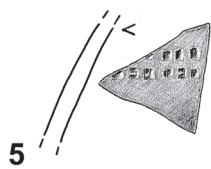
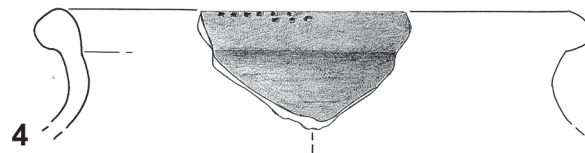
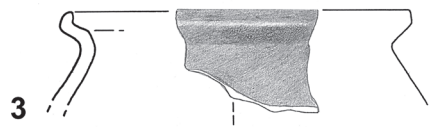
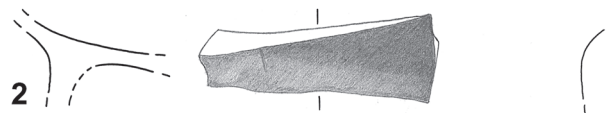
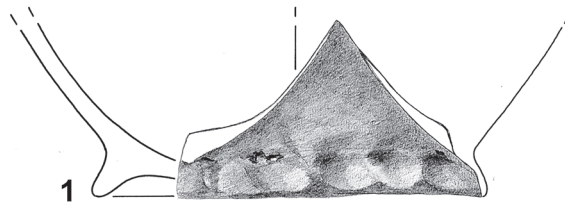

1–3: Warenart 05; 4 und 5: Warenart 06; 6: Warenart 07. – 1: Katalognummer 1753; 2: Katalognummer 1334.
3, 4 und 6: Katalognummer 1283; 5: Katalognummer 1255. – M 1:2.

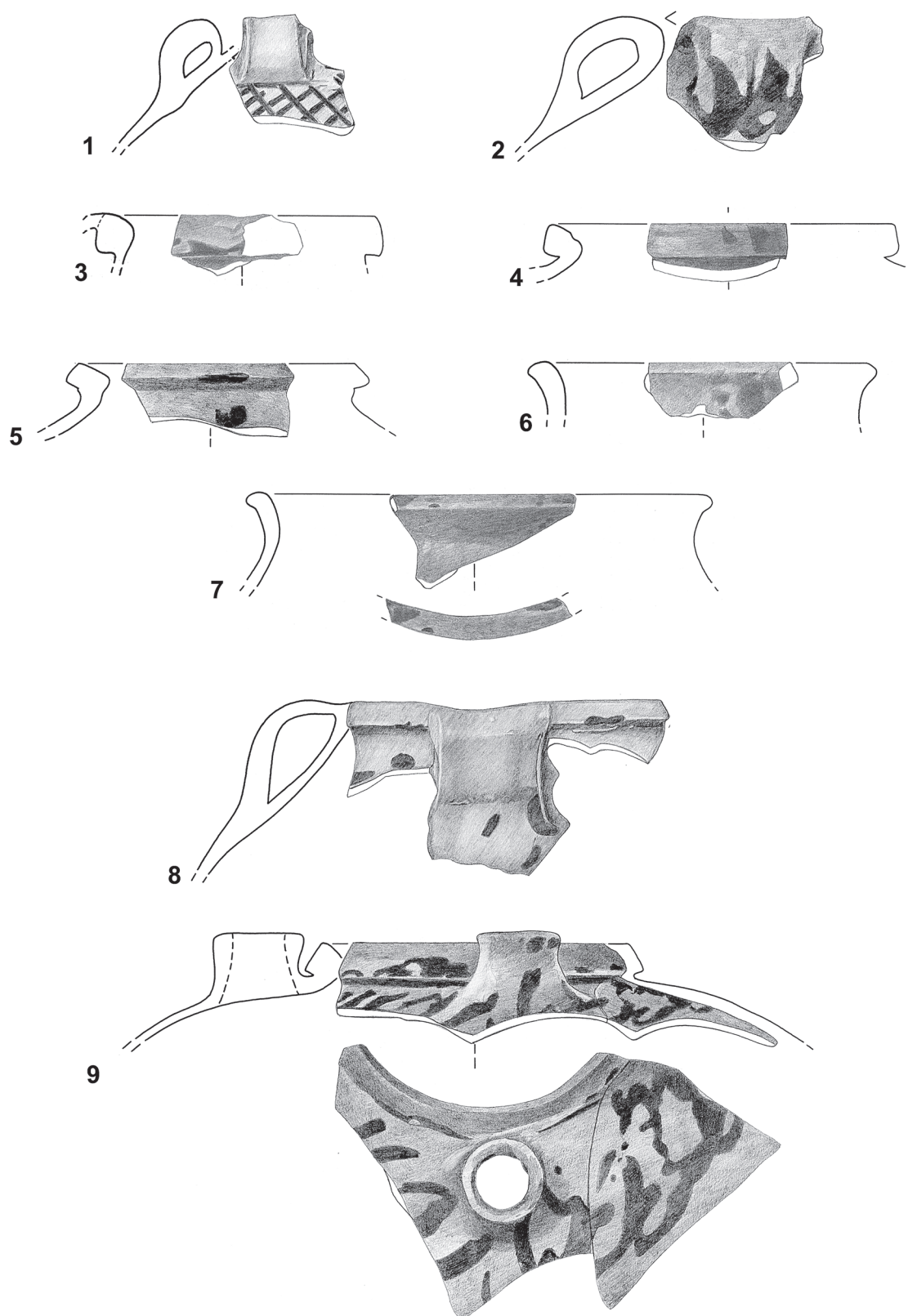

Warenart 08. 1, 2, 4, 6 und 7: Katalognummer 1753; 3, 5, 8 und 9: Katalognummer 1283. – M 1:2.

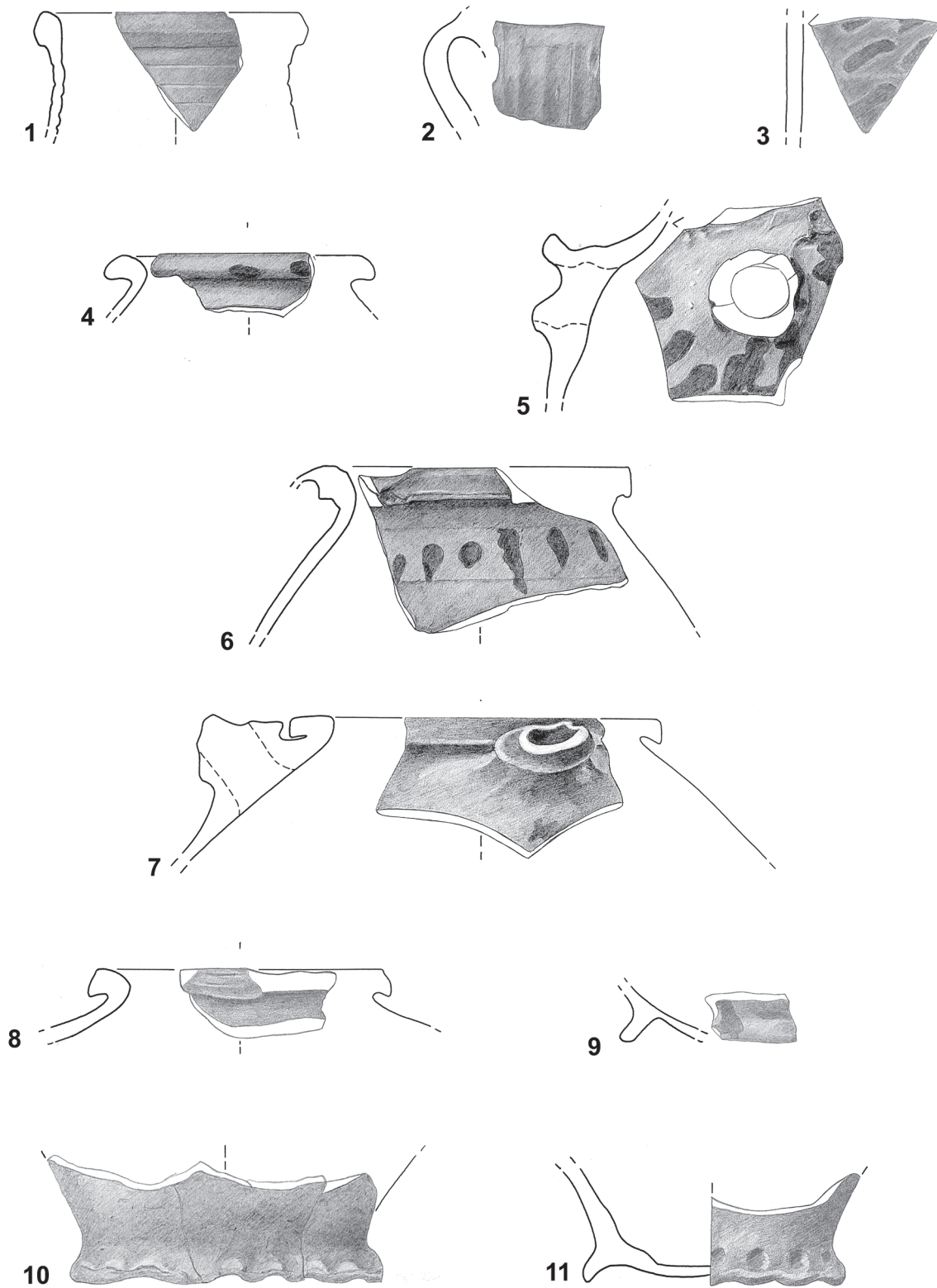

Warensart 08. 1, 4–8 und 11: Katalognummer 1283; 2: Katalognummer 1367; 3: Katalognummer 1729; 9: Katalognummer 1753; 10: Katalognummer 1329. – M 1:2.

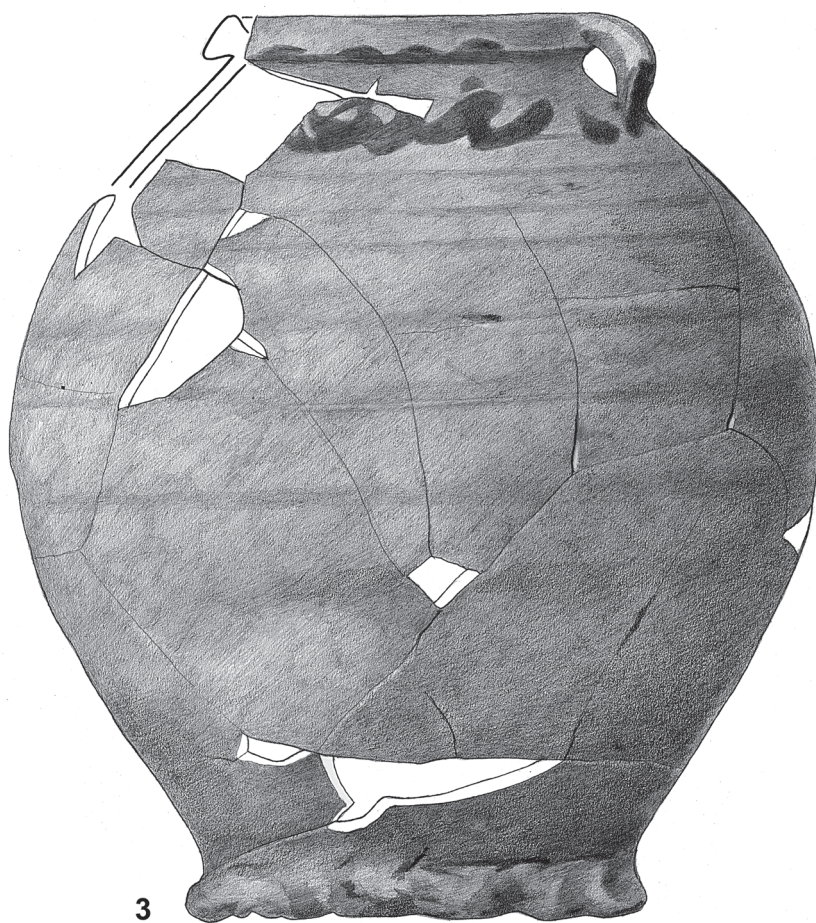
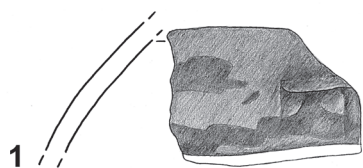

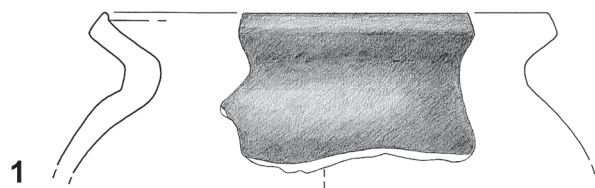

1

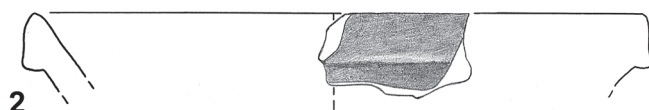

2

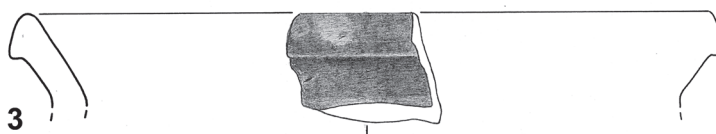

3

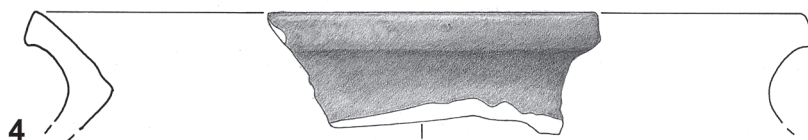

4

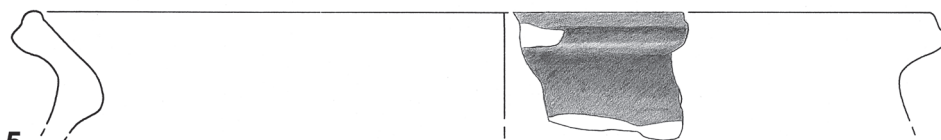

5

Warenart 11. 1: Katalognummer 1386; 2: Katalognummer 1124; 3 und 4: Katalognummer 1283; 5: Katalognummer 1109. –
M 1:2.

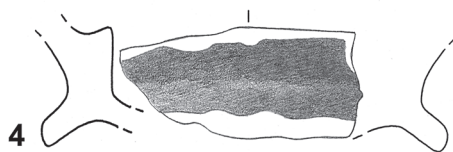
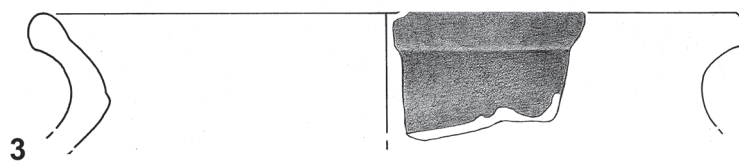
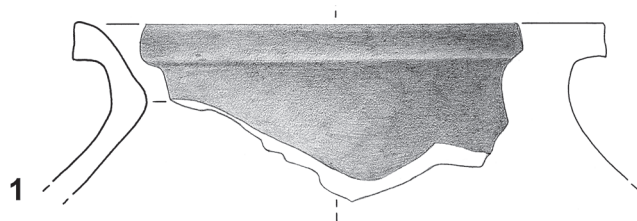

Warenart 11. 1 und 3–5: Katalognummer 1283; 2: Katalognummer 1738. – M 1:2.

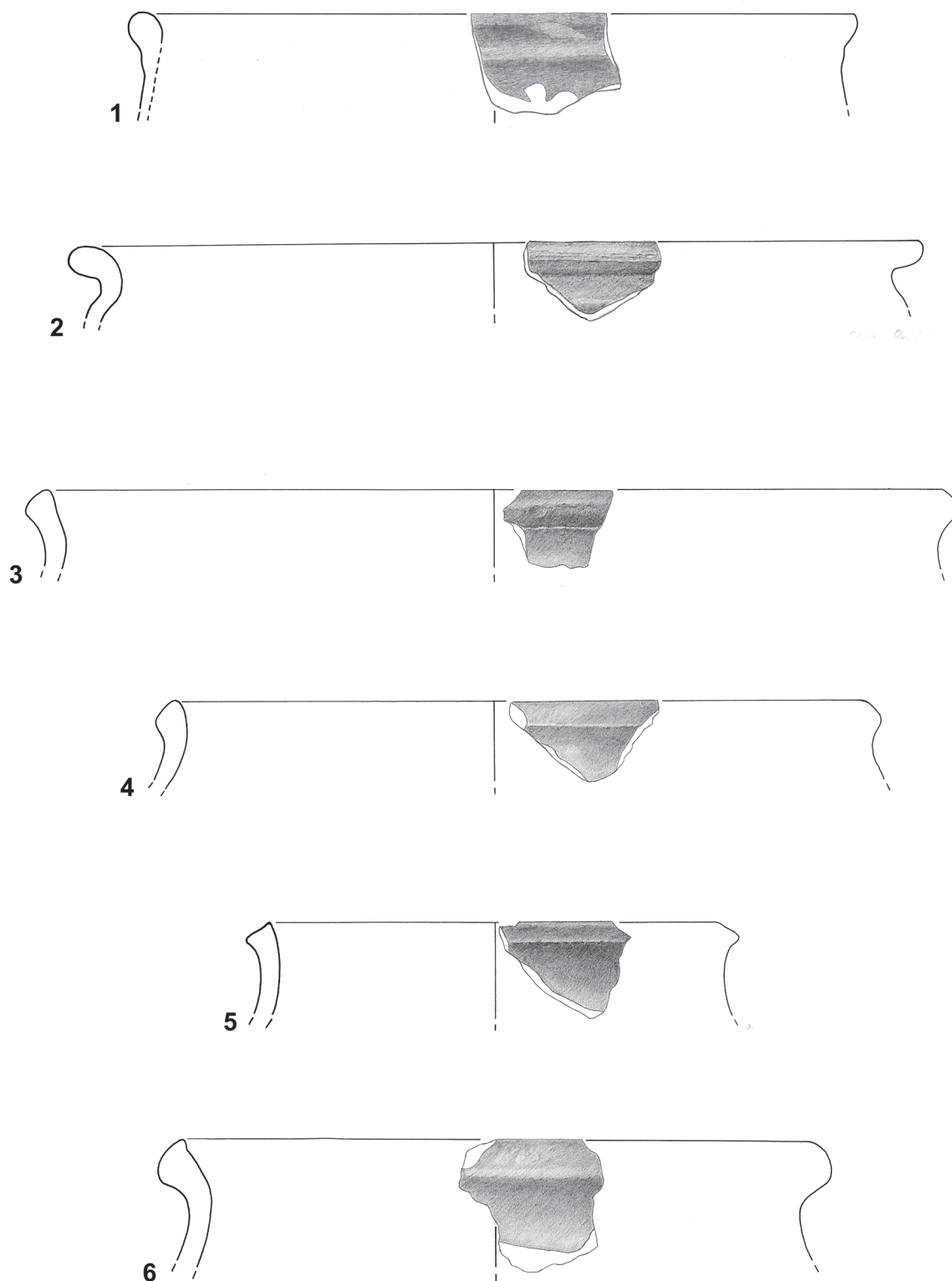

Warenart 12. 1 und 2: Katalognummer 1324; 3: Katalognummer 1753; 4: Katalognummer 1334; 5: Katalognummer 1327; 6: Katalognummer 1283. – M 1:2.

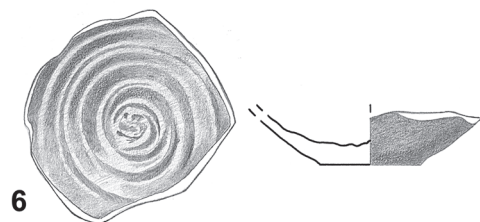
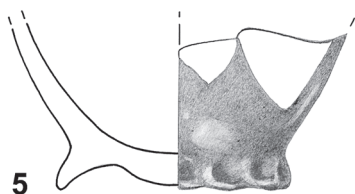
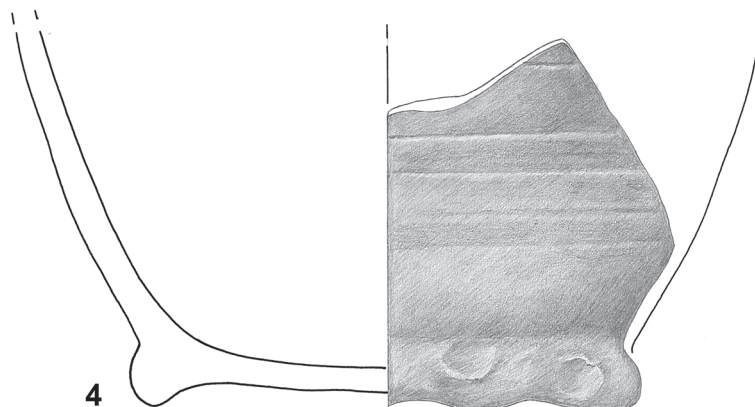
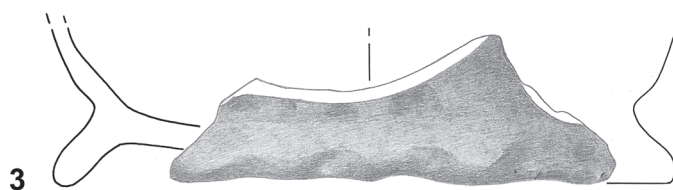
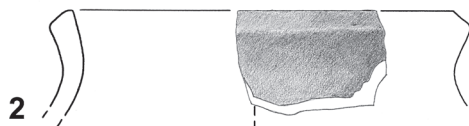
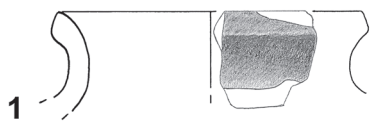

1-3: Warenart 13; 4: Warenart 14; 5 und 6: Warenart 15. – 1-4 und 6: Katalognummer 1283; 5: Katalognummer 1753. – M 1:2.

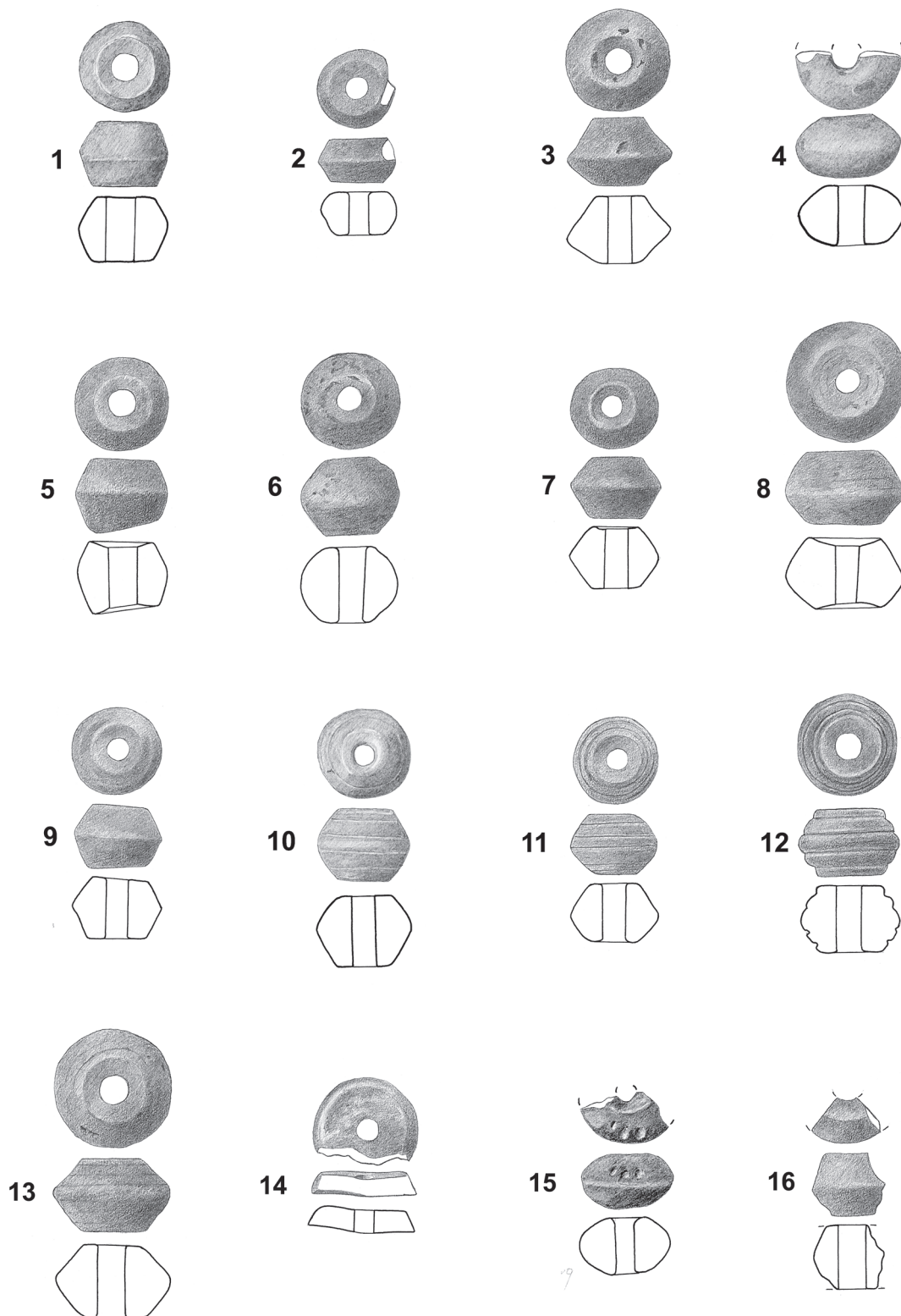

Spinnwirtel aus mittelalterlichen Befunden. 1–14: Katalognummer 1283; 15: Katalognummer 1323; 16: Katalognummer 1753. – M 1:2.

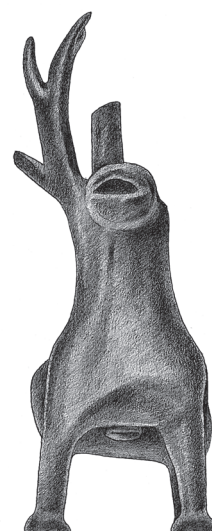
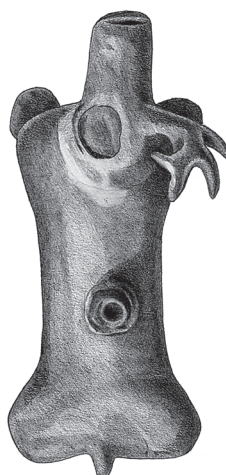
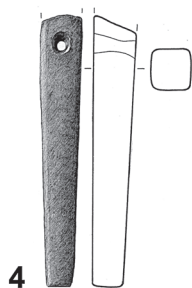
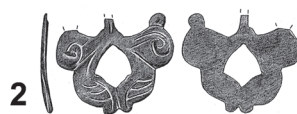

1: Katalognummer 1283; 2 und 5: Katalognummer 1738; 3: Katalognummer 1327; 4: Katalognummer 1332. –
1, 2 und 5: Kupferlegierung. 3 und 4: Stein. – 1, 2 und 5: M 1:2; 3 und 4: M 1:3.

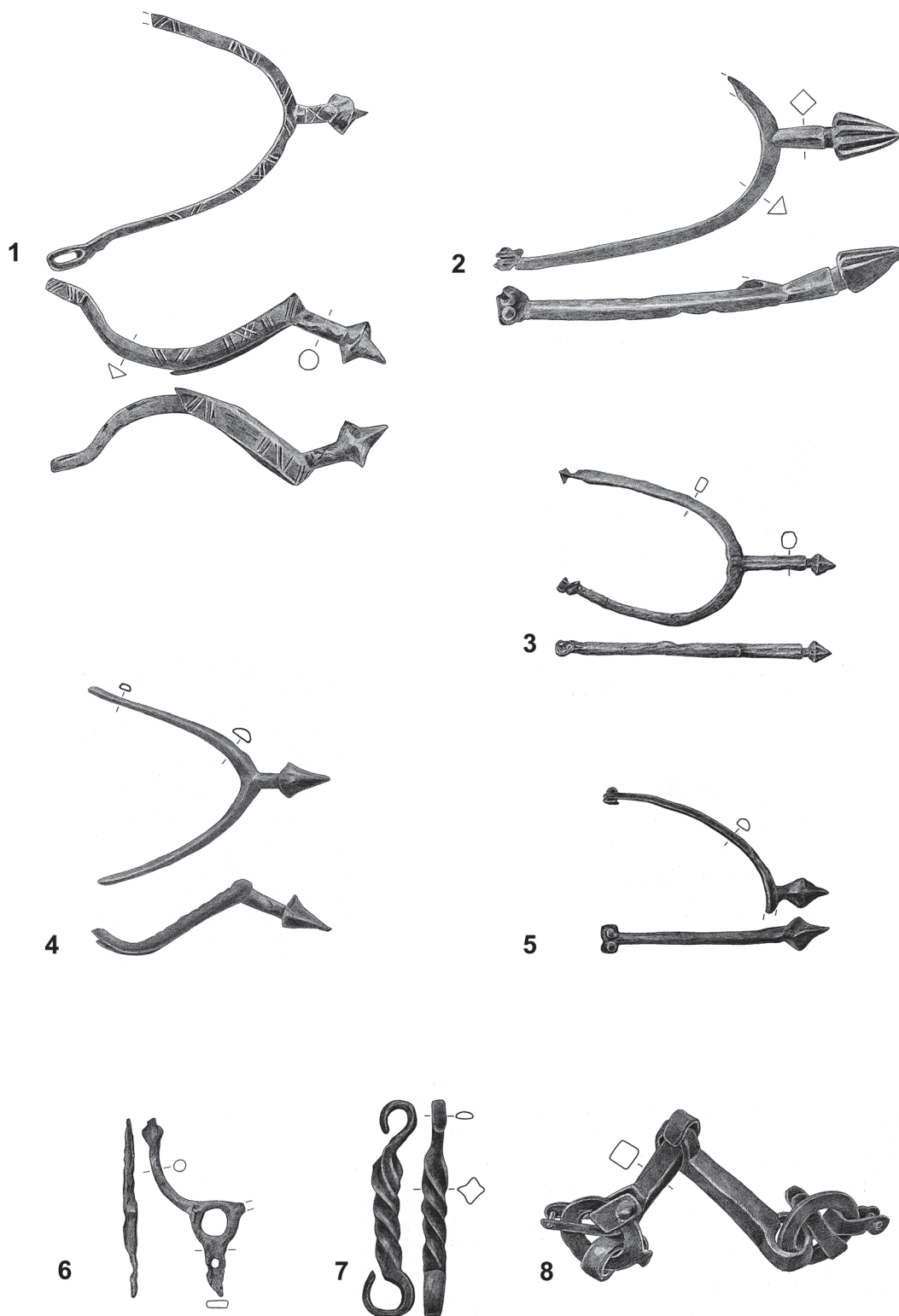

1 und 6: Katalognummer 1738; 2 und 5: Katalognummer 1272; 3, 4, 7 und 8: Katalognummer 1283. – Eisen. – M 1:3.

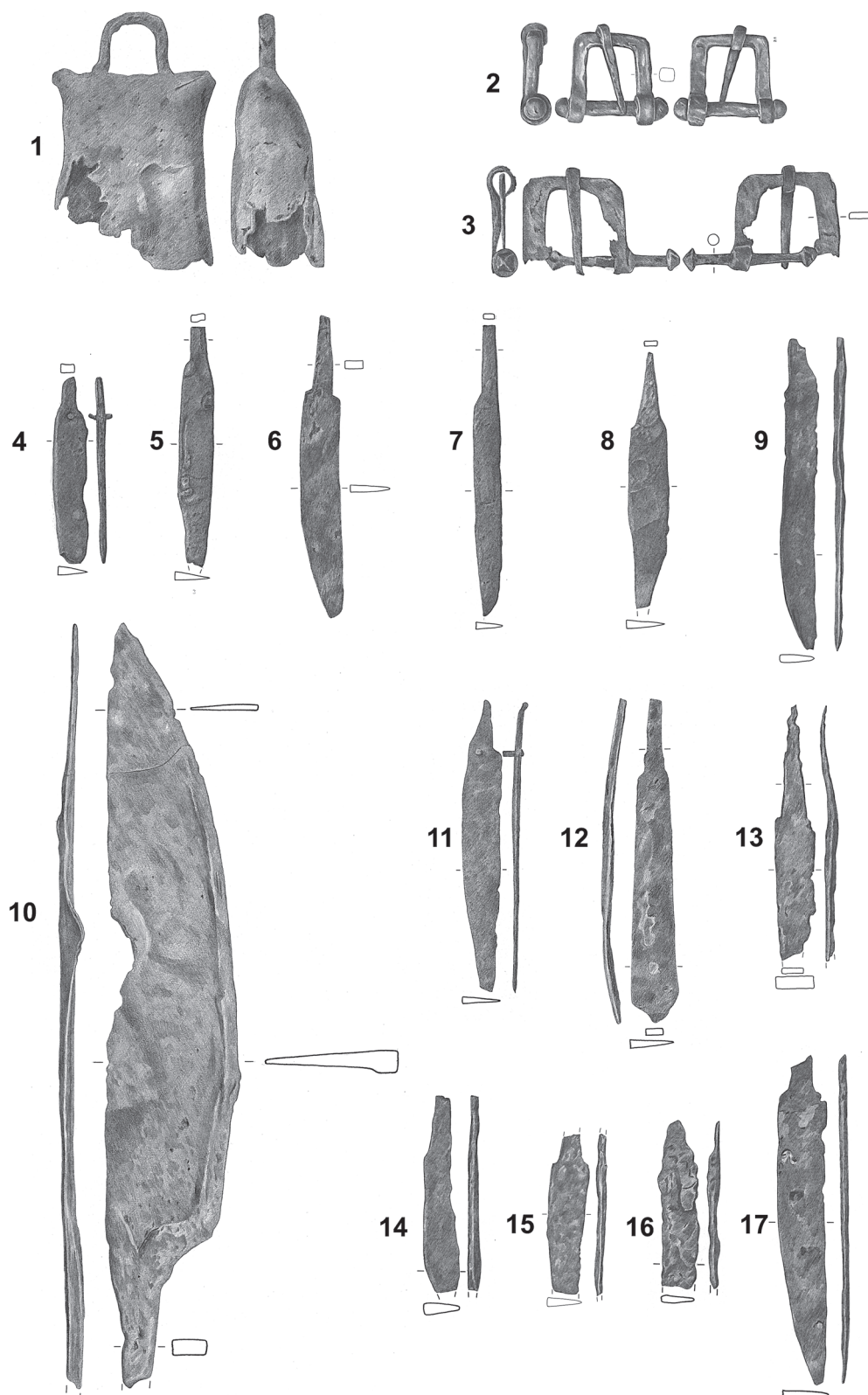

1, 2, 6, 9–13, 16 und 17: Katalognummer 1283; 3: Katalognummer 1738; 4 und 5: Lesefunde; 7: Katalognummer 1342; 8: Katalognummer 1327; 14 und 15: Katalognummer 1243. – Eisen. – M 1:3.

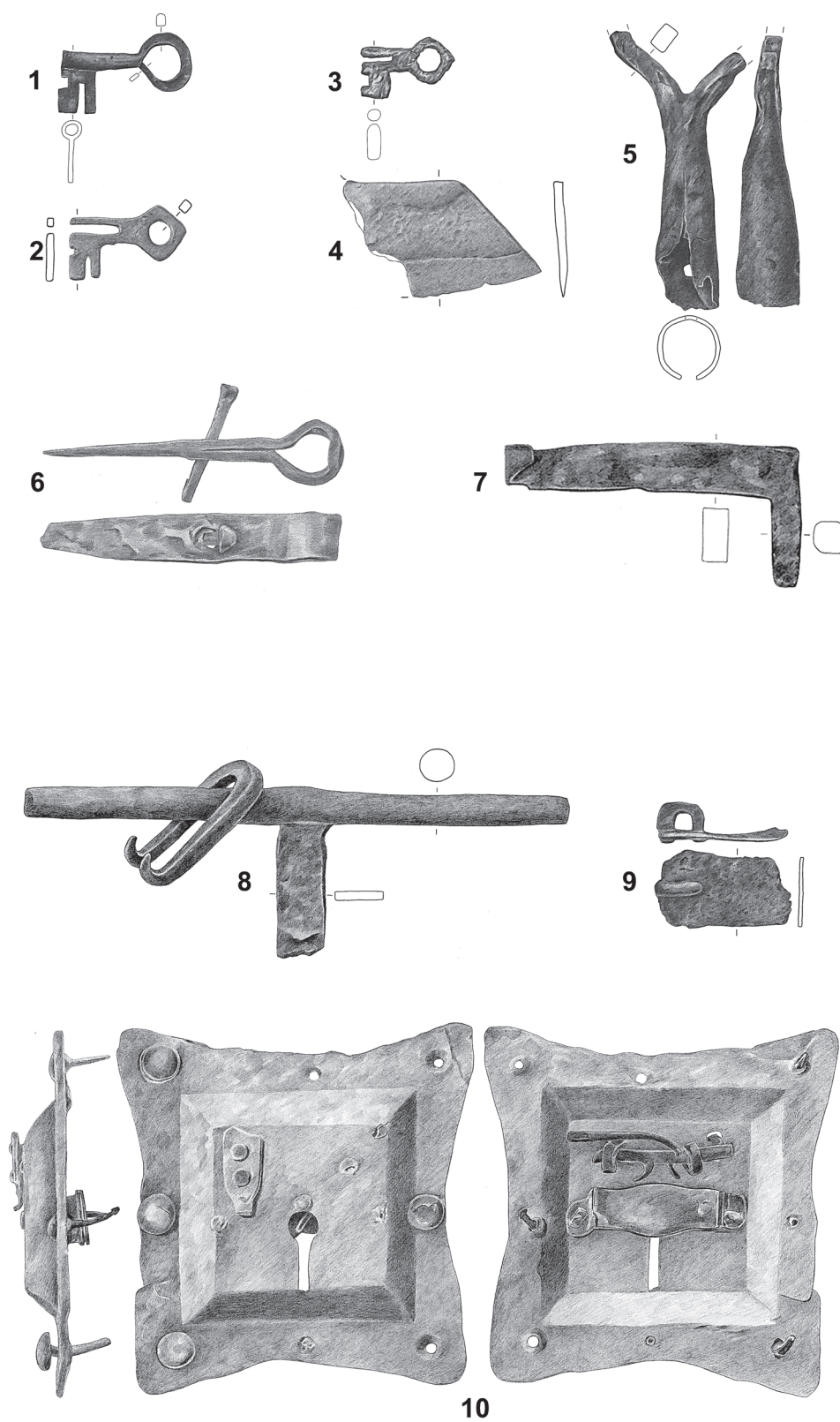

1, 2, 6–8 und 10: Katalognummer 1738; 3–5 und 9: Katalognummer 1283. – Eisen. – M 1:3.

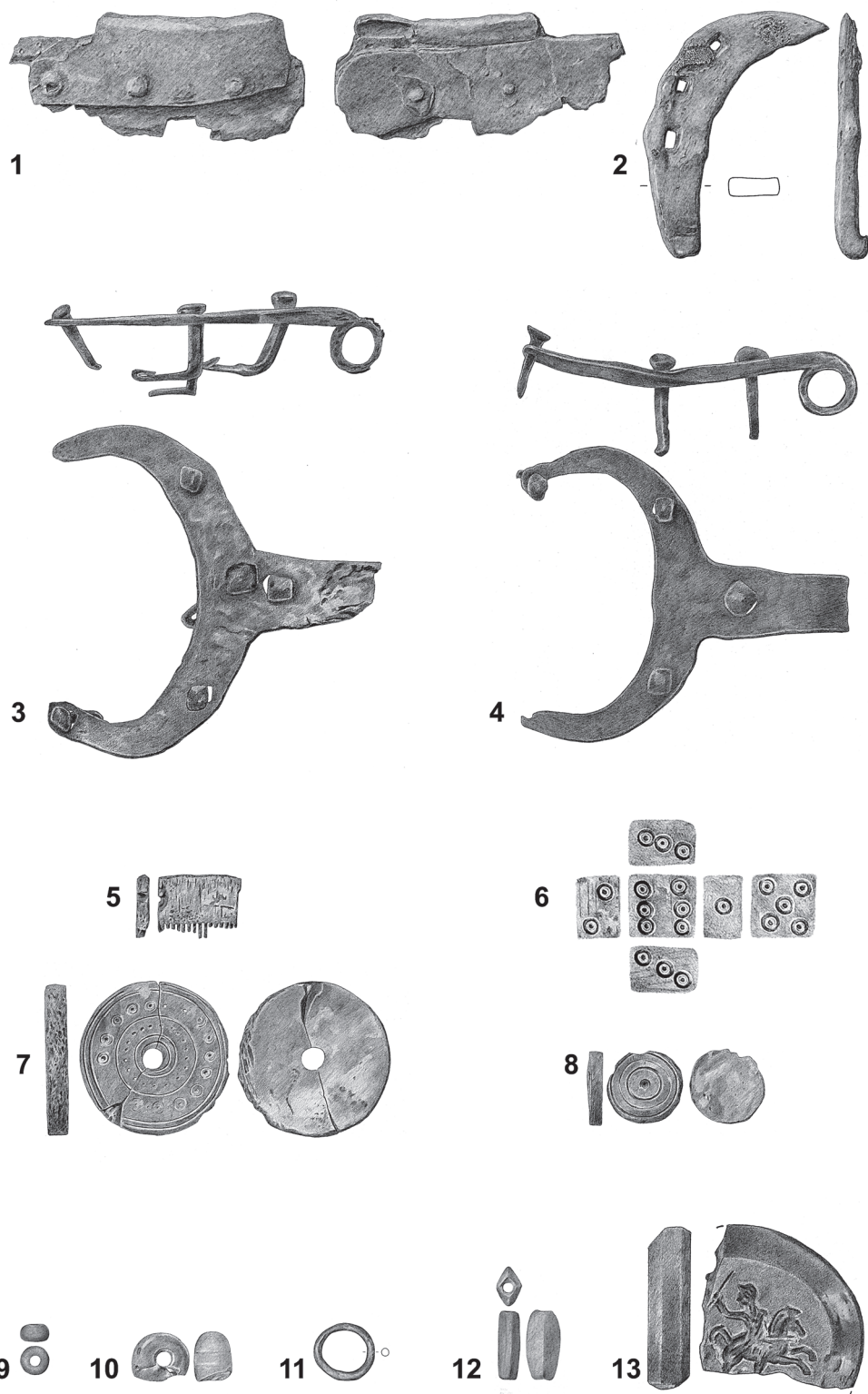

1: Katalognummer 1118; 2-4 und 6-13: Katalognummer 1283; 5: Katalognummer 1753. – 1-4: Eisen; 5-8: Knochen; 9-13: Glas. – 1-4: M 1:3; 5, 7-8: M 1:2; 6, 9-12: M 1:1; 13: M 2:1.

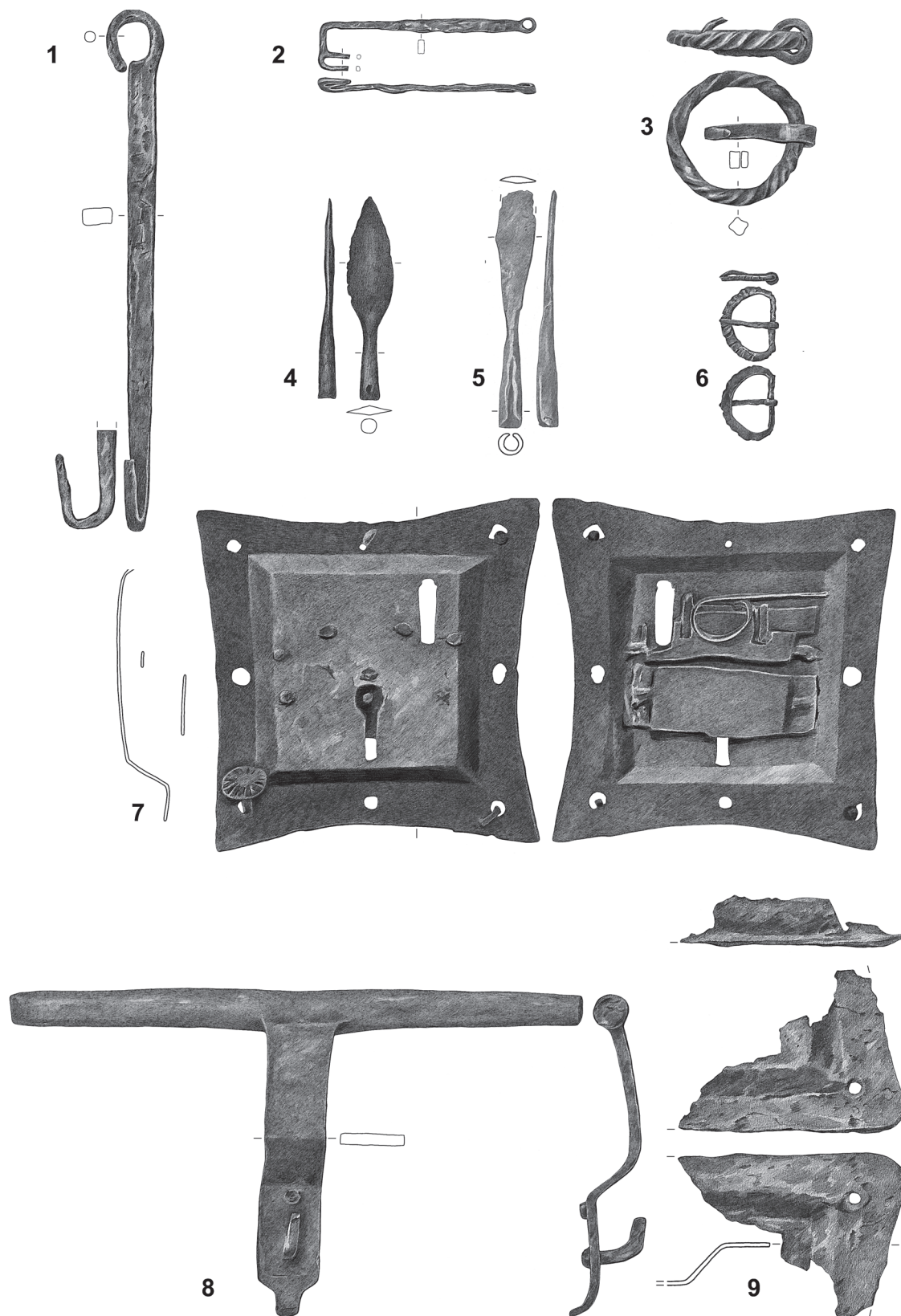

1 und 3-9: Katalognummer 1283; 2: Katalognummer 1243. – Eisen. – M 1:3.

Randform 1



Randform 2



Randform 2a

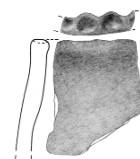
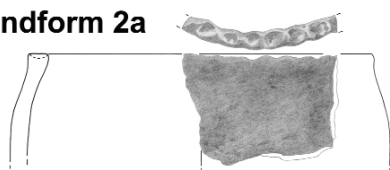

Randform 3a

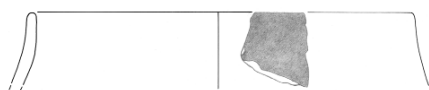

Randform 3b

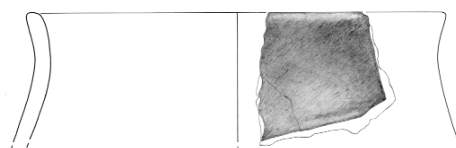

Randform 3c

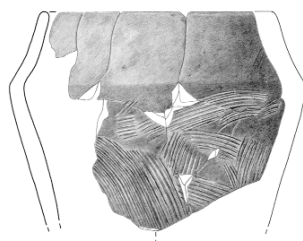

Randform 4

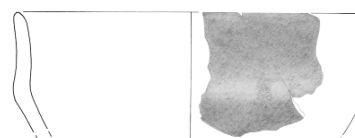

Randform 5

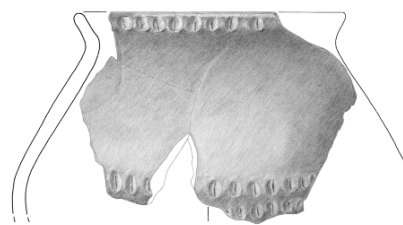
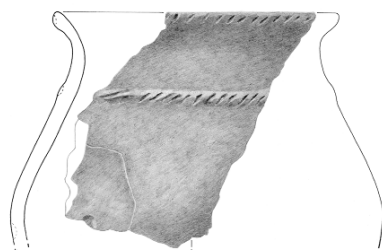

Randform 6

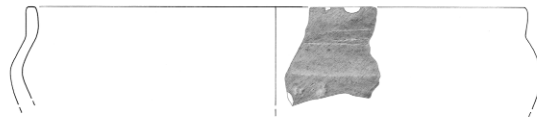

Randform 7

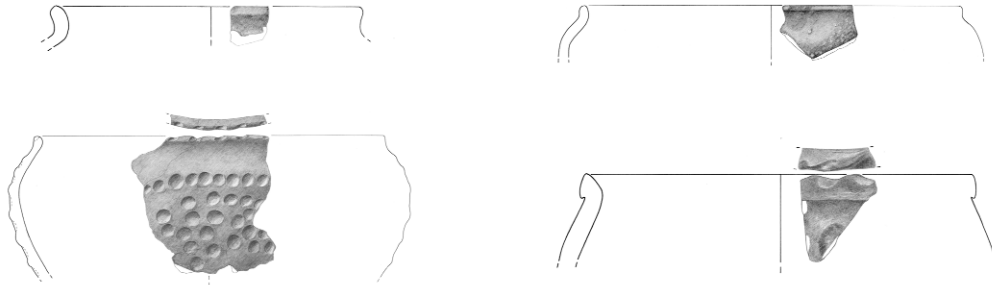

Randform 8



Randform 9

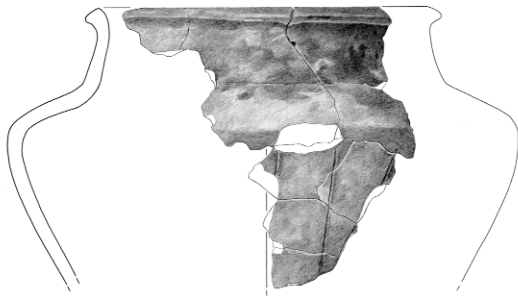

Randform 9a

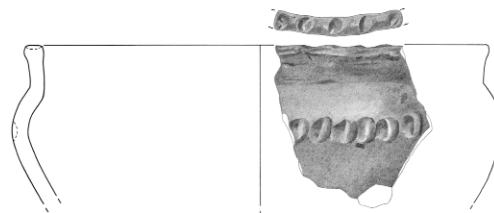

Randform 10a

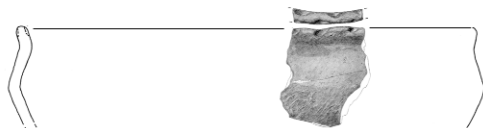

Randform 10b

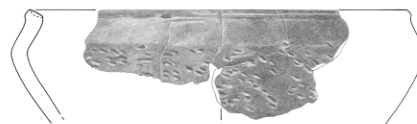

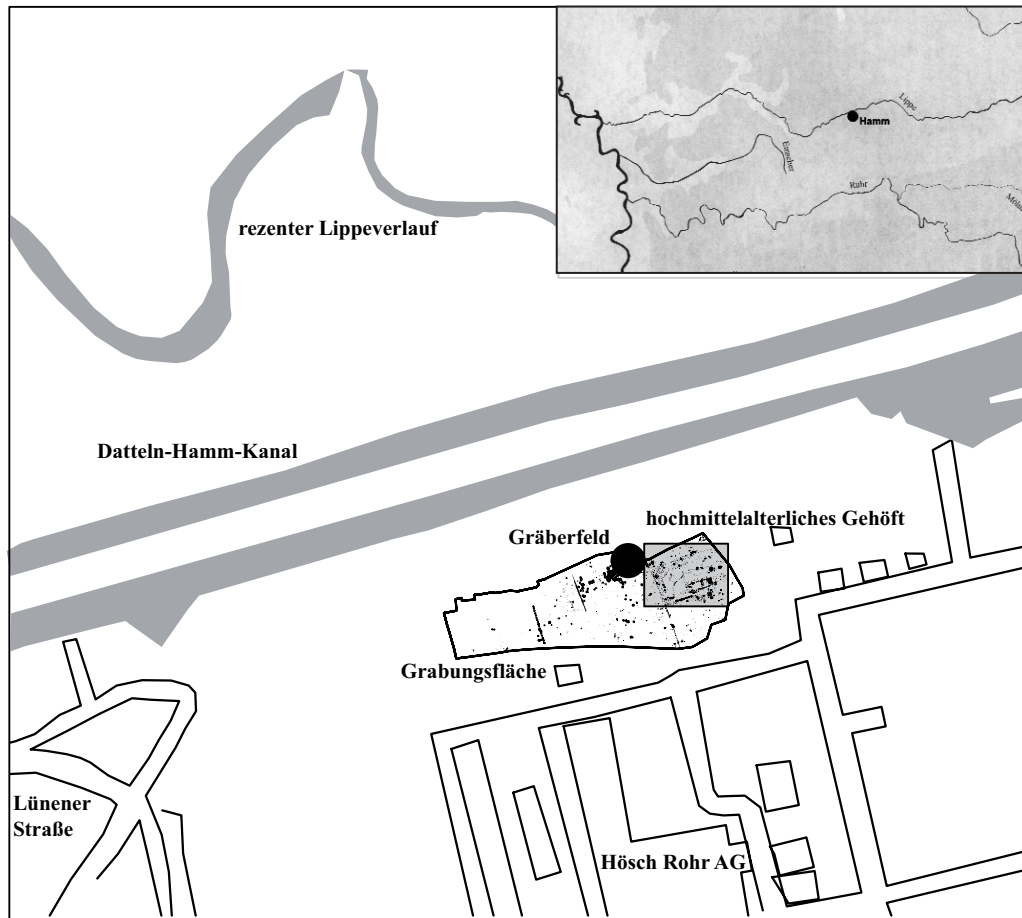

Geografische Lage des Fundplatzes. M 1:10.000, Übersichtskarte unmaßstäblich.

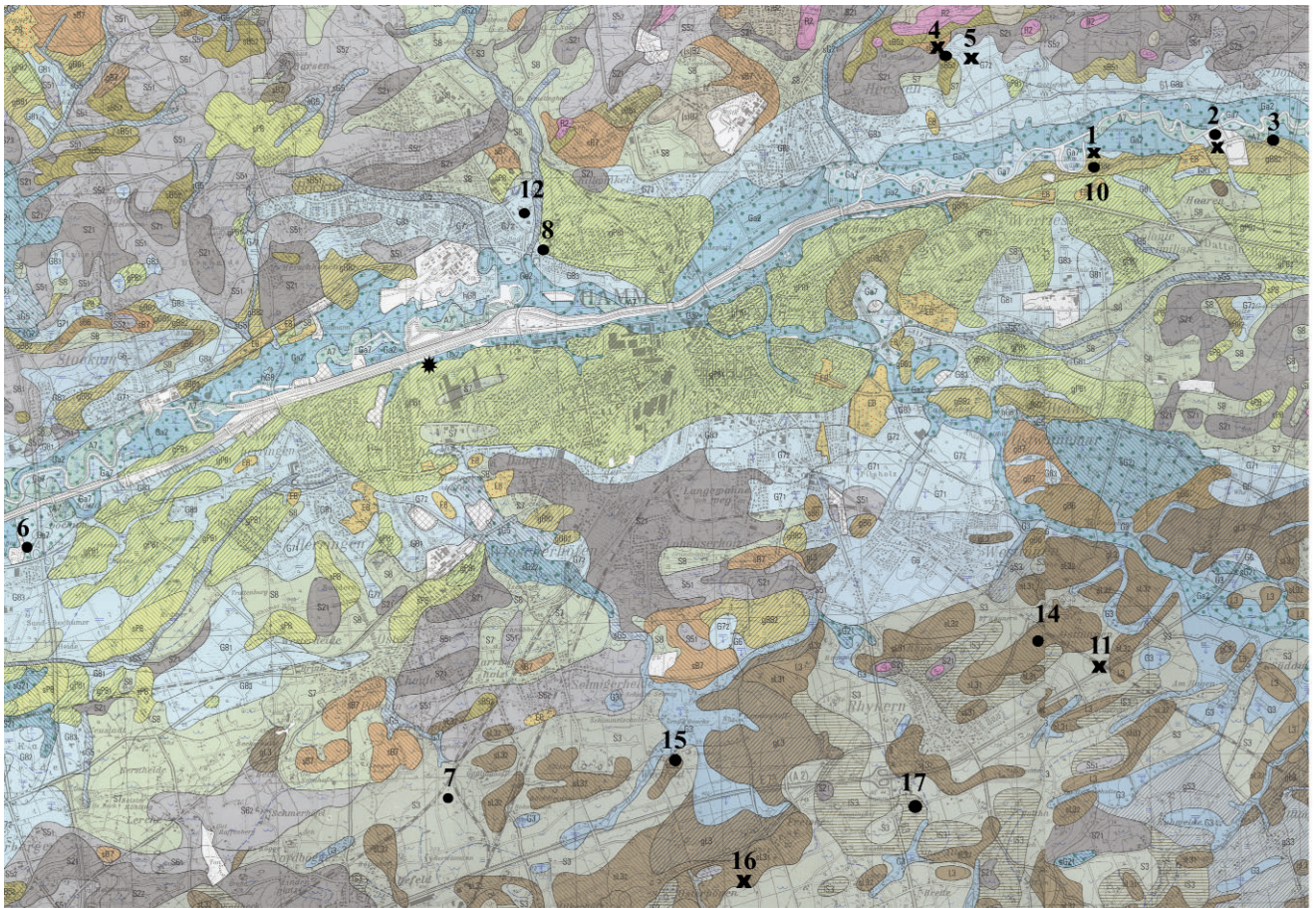

- eisenzeitliche Fundstellen * Fundplatz Hamm-Westhafen
- ✕ kaiserzeitliche Fundstellen

- 1: Werries, AKZ 4213,8: neolithische, eisenzeitliche, kaiserzeitliche und frühgeschichtliche Lesefunde von Bänfer 1939 protokolliert
- 2: Werries, AKZ 4213,10: Abbau einer Sandgrube, die stellenweise in einen alten Lippearm eingriff; geborgen wurden Scherben der vorrömischen Eisenzeit und der römischen Kaiserzeit
- 3: Haaren, AKZ 4213,13: eisenzeitliche Lesefunde
- 4: Heessen, AKZ 4213,14: eisenzeitliche und kaiserzeitliche Lesefunde
- 5: Heessen, AKZ 4213,15: Lesefunde, zeitlich in den Übergangshorizont eingeordnet
- 6: Sandbochum, AKZ 4312,14: vor- und frühgeschichtlicher Siedlungsplatz zwischen Bumannsburg und AB A1
- 7: Pelkum, AKZ 4312,19: eisenzeitlicher Siedlungsplatz
- 8: Hövel, AKZ 4312,35: Urnenfriedhof und Siedlung der Eisenzeit, Lesefunde von der Oberfläche,
- 9: Rhynern, AKZ 4313,6: Brandgrube mit Rautopfscherben der römischen Kaiserzeit
- 10: Werries, AKZ 4313,40: eisenzeitliche und kaiserzeitliche Lesefunde
- 11: Osttünen, AKZ 4313,67: Siedlung der älteren Kaiserzeit nach einem Hinweis aus dem Messtischblatt Beck
- 12: Herringen, AKZ 4312,7: germanische Siedlungsgrube des 1. Jahrhunderts
- 13: Osterflerich, AKZ 4413,3: Gruben mit stark holzkohlehaltigem Inhalt in die Übergangszeit datiert
- 14: Osttünen, AKZ 4313,12 u. 13: Grube mit stark holzkohlehaltigem Inhalt und Keramik der vorrömischen Eisenzeit
- 15: Weetfeld, AKZ 4312,22: Gruben mit Holzkohle und Rotlehm sowie eisenzeitlichen Scherben
- 16: Freiske, AKZ 4312,9: große Grube mit Brandschutt, Funde der jüngeren Kaiserzeit
- 17: Rhynern, AKZ 4313,16: eisenzeitliches Gräberfeld

Kartierung der eisenzeitlichen und kaiserzeitlichen Fundstellen im Stadtgebiet von Hamm. Legende siehe auch Liste 1, S. 171.

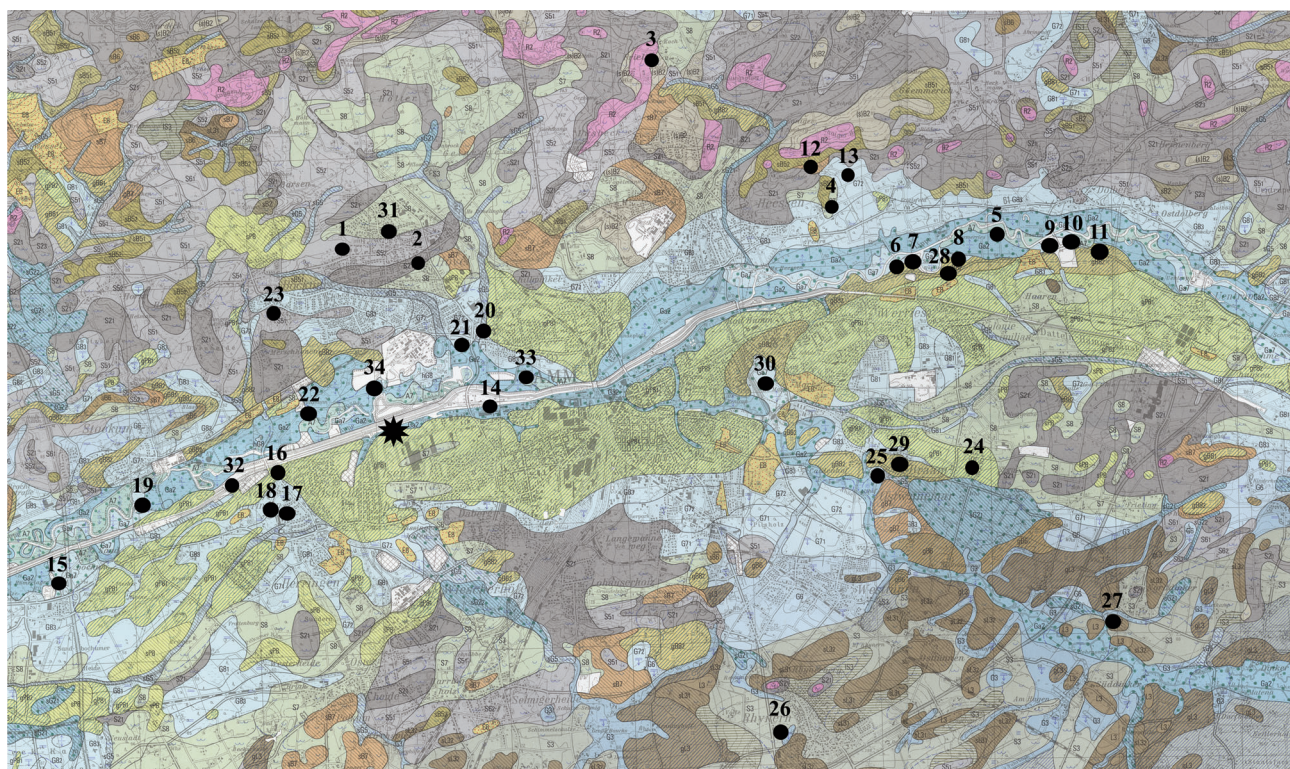

● mittelalterliche Fundstellen ★ Fundplatz Hamm-Westhafen

- | | |
|---|--|
| 1: Bockum-Hövel, AKZ 4215,5: Leseefunde | 21: Bockum-Hövel, AKZ 4312,52: Leseefunde nach Katasterplan Schauerte 1957 |
| 2: Bockum-Hövel, AKZ 4212,6: Leseefunde | 22: Bockum-Hövel, AKZ 4312,58: Scherben, Skelettfund, Steigbügel und Schwert |
| 3: Heessen, AKZ 4212,13: Leseefunde, darunter graublau Kugeltopfware und Siegburger Ware | 23: Bockum-Hövel, AKZ 4312,59: Baumsärge mit Skeletten |
| 4: Heessen, AKZ 4213,2: Leseefund | 24: Braam, AKZ 4313,14: Leseefunde: Kugeltopfscherben, rheinisches Steinzeug und grauschwarze Ware |
| 5: Haaren, AKZ 4213,5: Leseefund | 25: Braam, AKZ 4313,19: Leseefunde, geschmauchte und rote Ware nach Abschrift Bänfer |
| 6: Werries, AKZ 4213,6: Körperfriedhof | 26: Rhyern, AKZ 4313,20: schwarzgeschmauchte Ware, darunter Wellenfußfragmente |
| 7: Werries, AKZ 4213,7: Leseefunde | 27: Frielinghausen, AKZ 4313,33: Leseefunde |
| 8: Werries, AKZ 4213,8: Leseefunde | 28: Werries, AKZ 4313,40: Leseefunde |
| 9: Haaren, AKZ 4213,10: Leseefunde | 29: Braam, AKZ 4313,50: Leseefunde |
| 10: Haaren, AKZ 4213,12: Leseefunde | 30: Mark, AKZ 4313,57: Burg Mark |
| 11: Haaren, AKZ 4213,13: Leseefunde | 31: Bockum-Hövel, AKZ 4212,20: Burg Hövel |
| 12: Heessen, AKZ 4213,14: Leseefunde | 32: Herringen, AKZ 4312,15: Homburg |
| 13: Heessen, AKZ 4213,15: Leseefunde | 33: Bockum-Hövel, AKZ 4312,44: mit den Flurnamen »Steinwinkel« oder »Borgstätte« belegt, eventuell ehemaliger Standort der Burg Nienbrügge |
| 14: Hafen, AKZ 4312,8: Leseefunde | 34: Bockum-Hövel: Burg Hövel der Grafen von Berg(?) |
| 15: Sandbochum, AKZ 4312,14: Siedlung Eisenzeit, Kaiserzeit und Mittelalter | |
| 16: Herringen, AKZ 4312,24: ehem. Haus Herringen/Urnenfriedhof. | |
| 17: Herringen, AKZ 4312,27: Siedlung | |
| 18: Herringen, AKZ 4312,33: Leseefunde | |
| 19: Sandbochum, AKZ 4312,42: Haus Stockum. | |
| 20: Bockum-Hövel, AKZ 4312,51: Burg Geinegge. Funde: geschmauchte, grauschwarze Ware und Pingsdorfer Ware | Außerhalb des Kartenausschnitts: |
| | 35: Ostflierich: Brandgruben unter anderem mit grauen, grob-gemagerten Kugeltöpfen |

Kartierung der mittelalterlichen Fundstellen im Stadtgebiet von Hamm. Ausführliche Legende siehe Liste 2, S. 172.

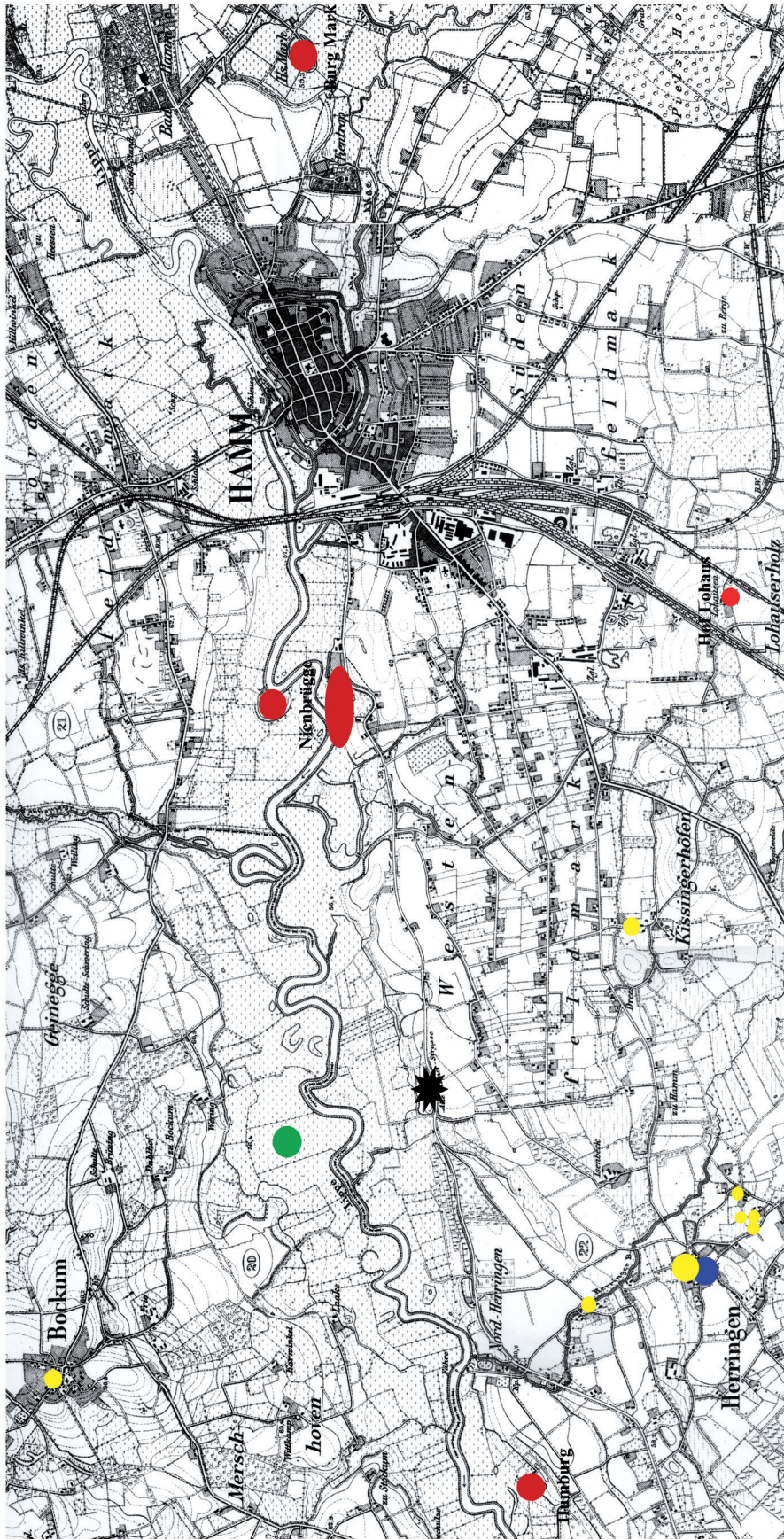

Das Kirchspiel Herringen und seine Entwicklung vom 10. bis zum 12. Jahrhundert. M 1:40.000.
 Kartengrundlage: Königl. Preuss. Landesaufnahme 1895, hsg. 1897, Blätter 2361, 2362, 2434, 2435.

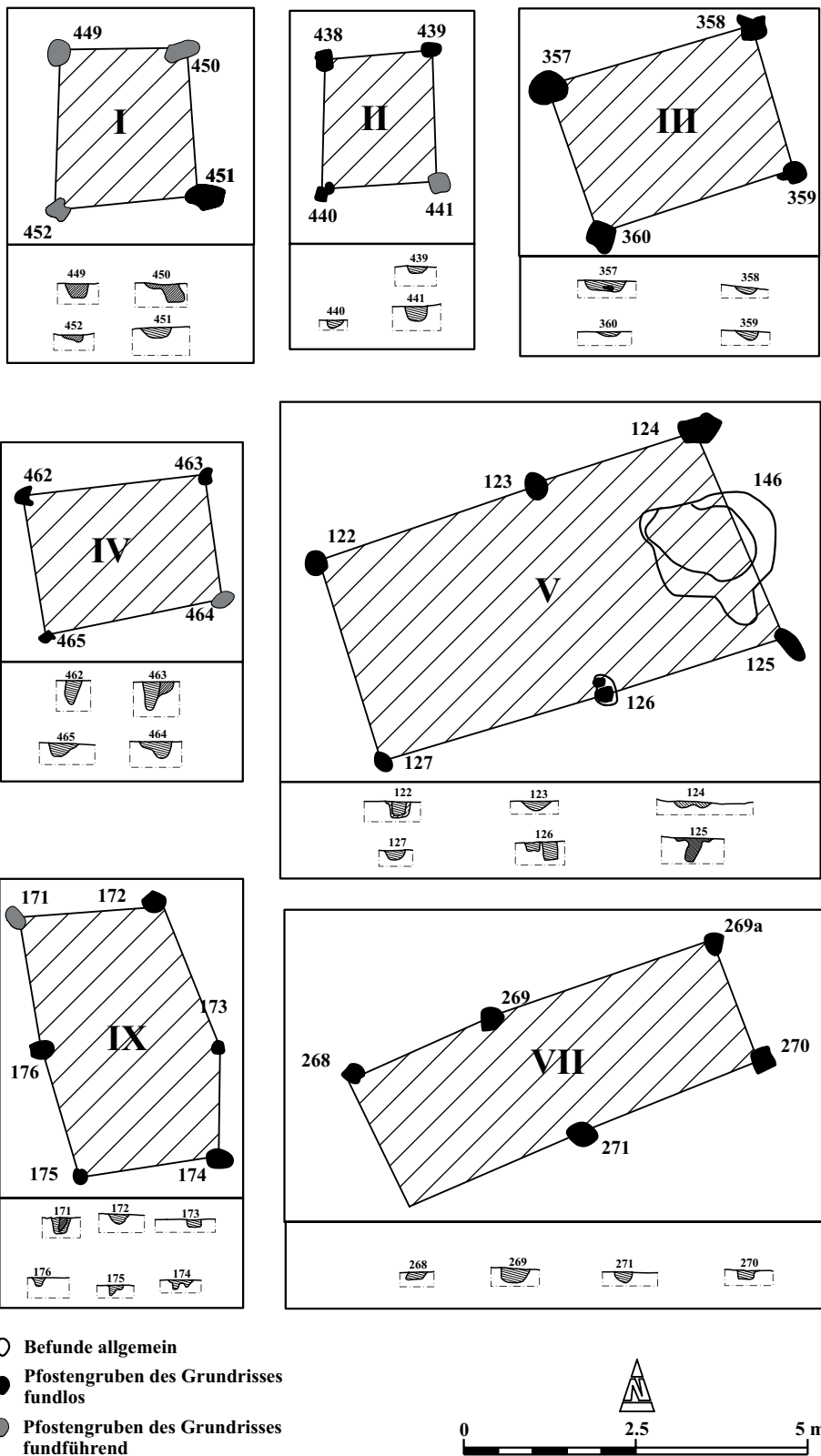

Bauten I, II, III, IV, V, VII, IX der vorrömischen Eisenzeit und der römischen Kaiserzeit. M 1:100.

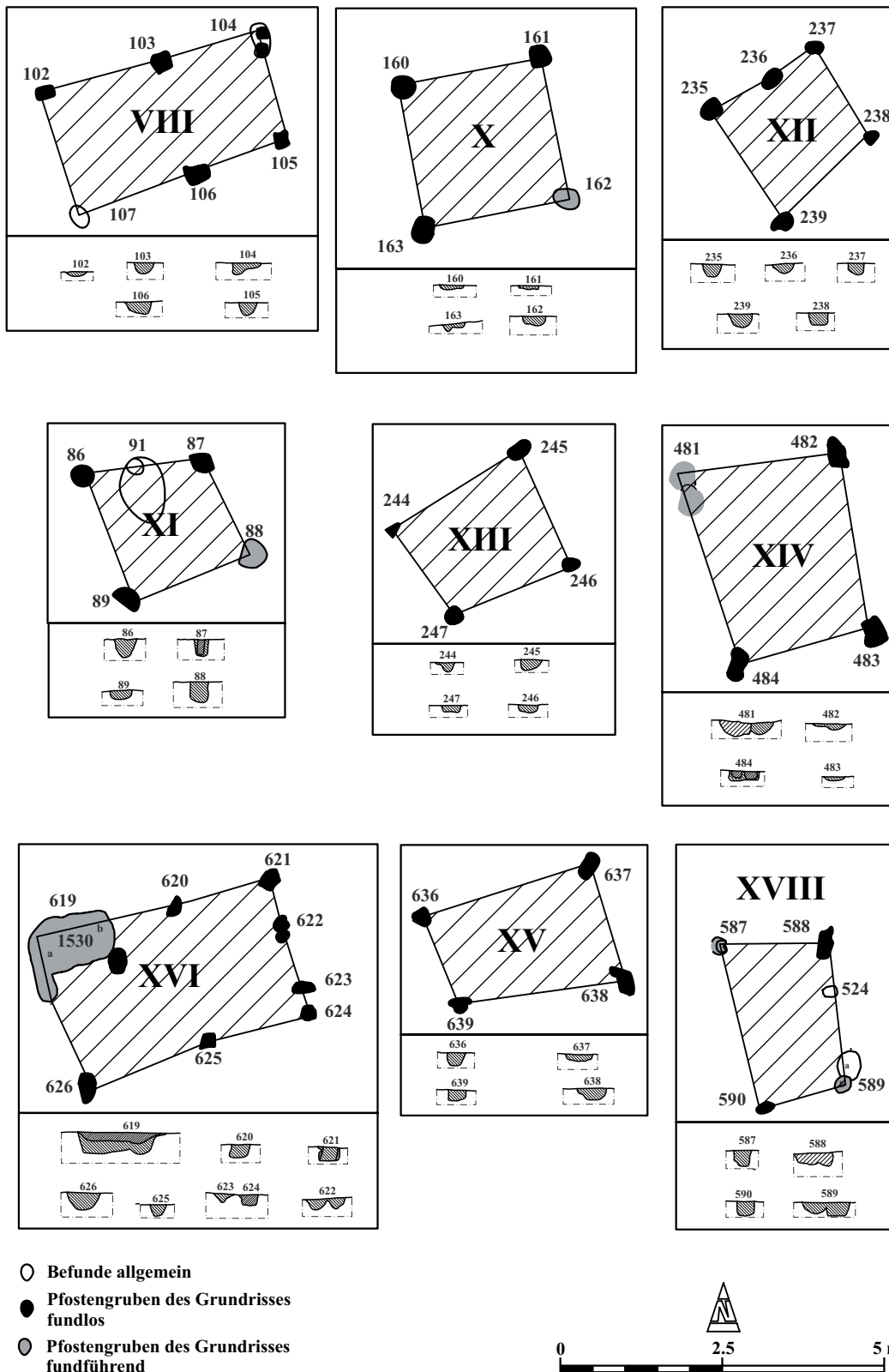

Bauten VIII, X–XVI, XVIII der vorrömischen Eisenzeit und der römischen Kaiserzeit. M 1:100.

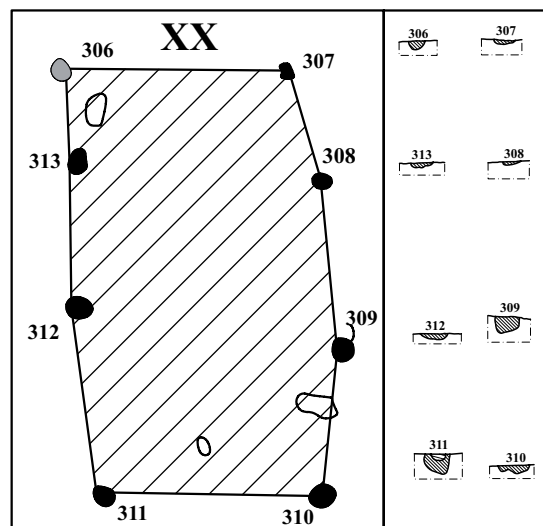
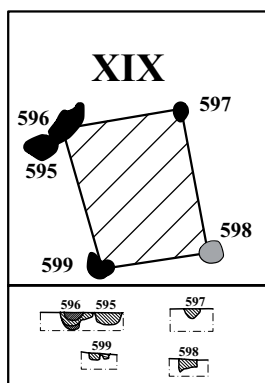
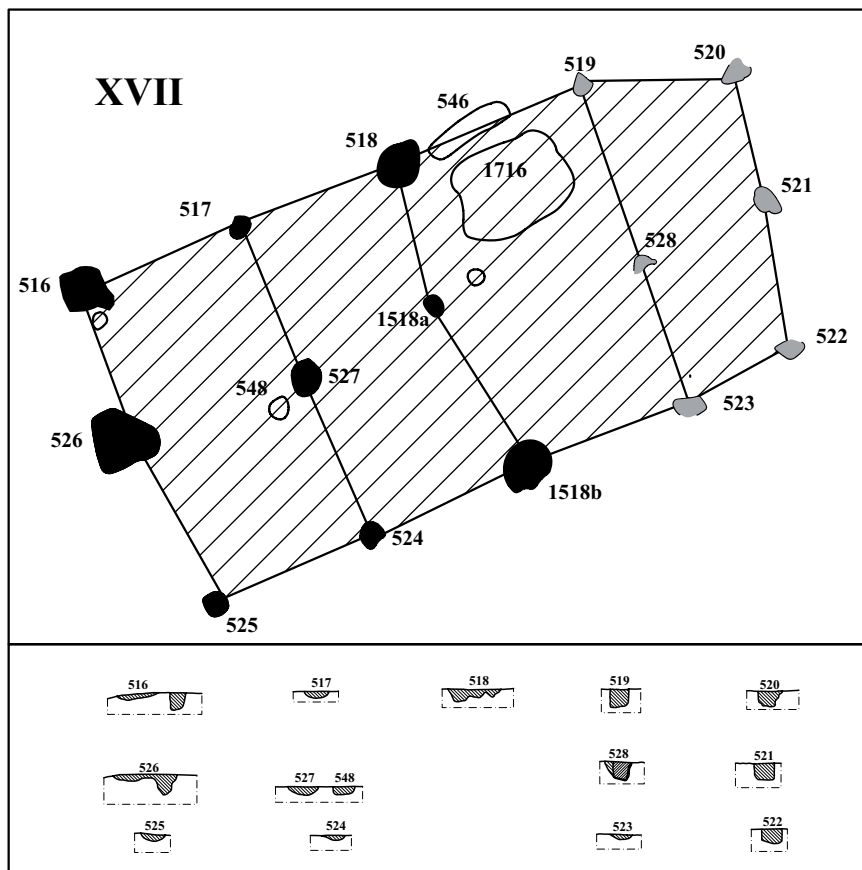

- Befunde allgemein
- Pfostengruben des Grundrisses fundlos
- Pfostengruben des Grundrisses fundführend

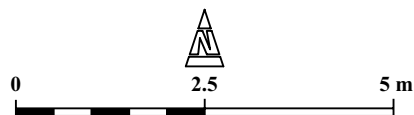

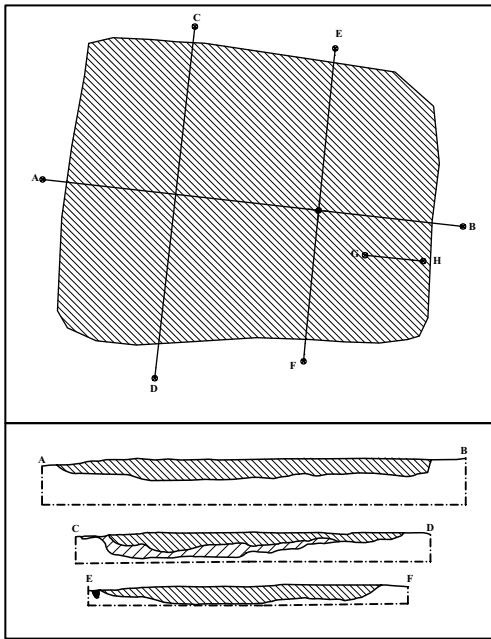

Bauten XVII, XIX, XX der vorrömischen Eisenzeit und der römischen Kaiserzeit. M 1:100.

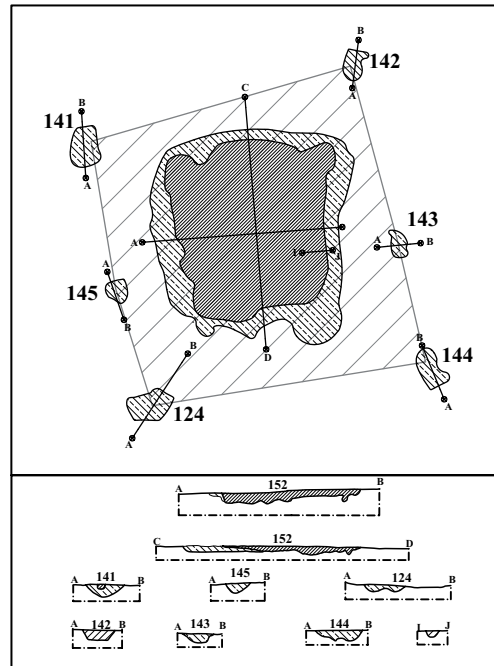

Grubenhaus 558



Grubenhaus 152 und Pfostenstellung 124, 141–145
(Bau VI)

-  schwarzgrauer Sand
-  grauer Sand
-  hellgrauer Sand

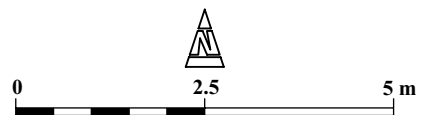

Eisen- bis kaiserzeitliche Grubenhäuser 558 und 152. M 1:100.

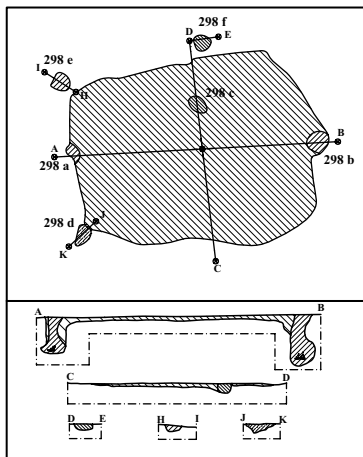



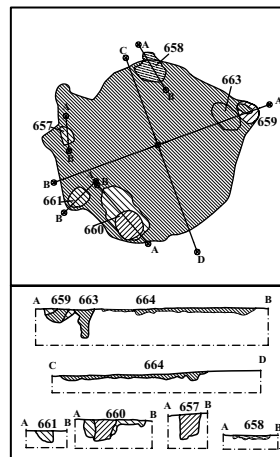

Grubenhaus 298

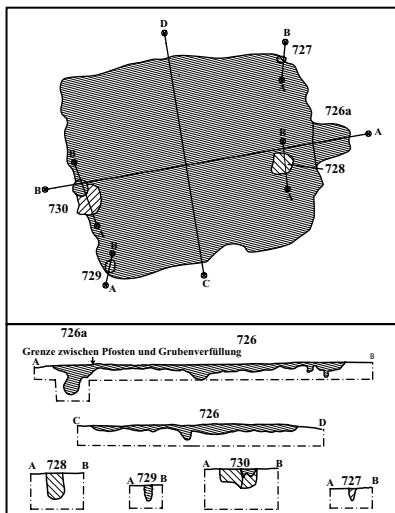

Grubenhaus 664



Grubenhaus 726

-  schwarzgrauer Sand
-  grauer Sand
-  hellgrauer Sand
-  dunkelgrauer Sand
-  brauner Sand

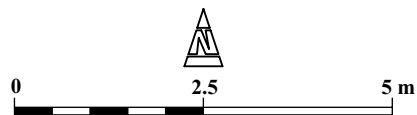

Eisen- bis kaiserzeitliche Grubenhäuser 298, 664, 726. M 1:100.

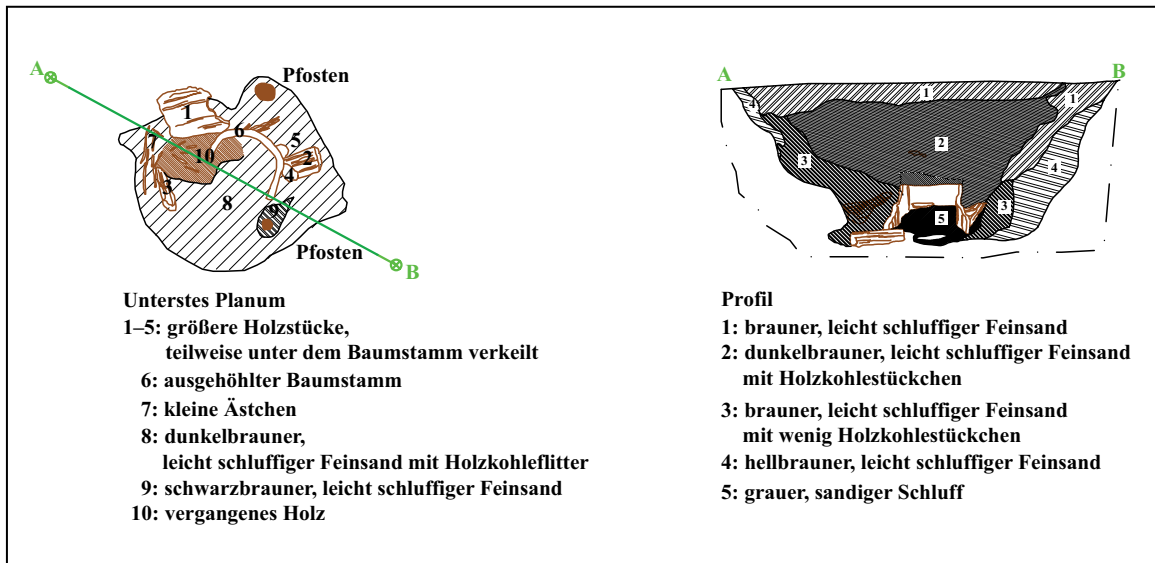

Brunnen 25

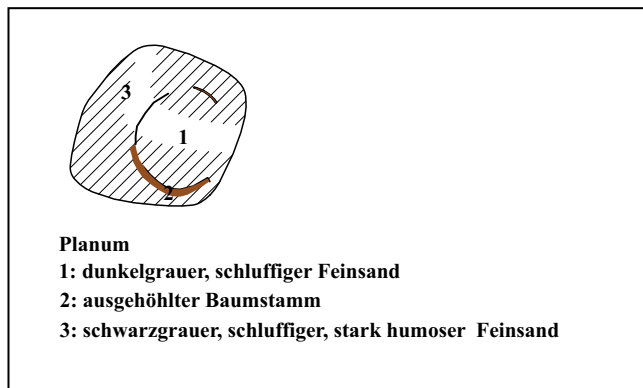

Brunnen 1167

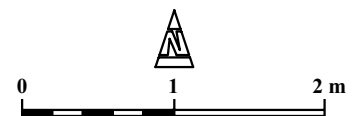

Eisen- bis kaiserzeitliche Brunnen 25 und 1167. M 1:50.

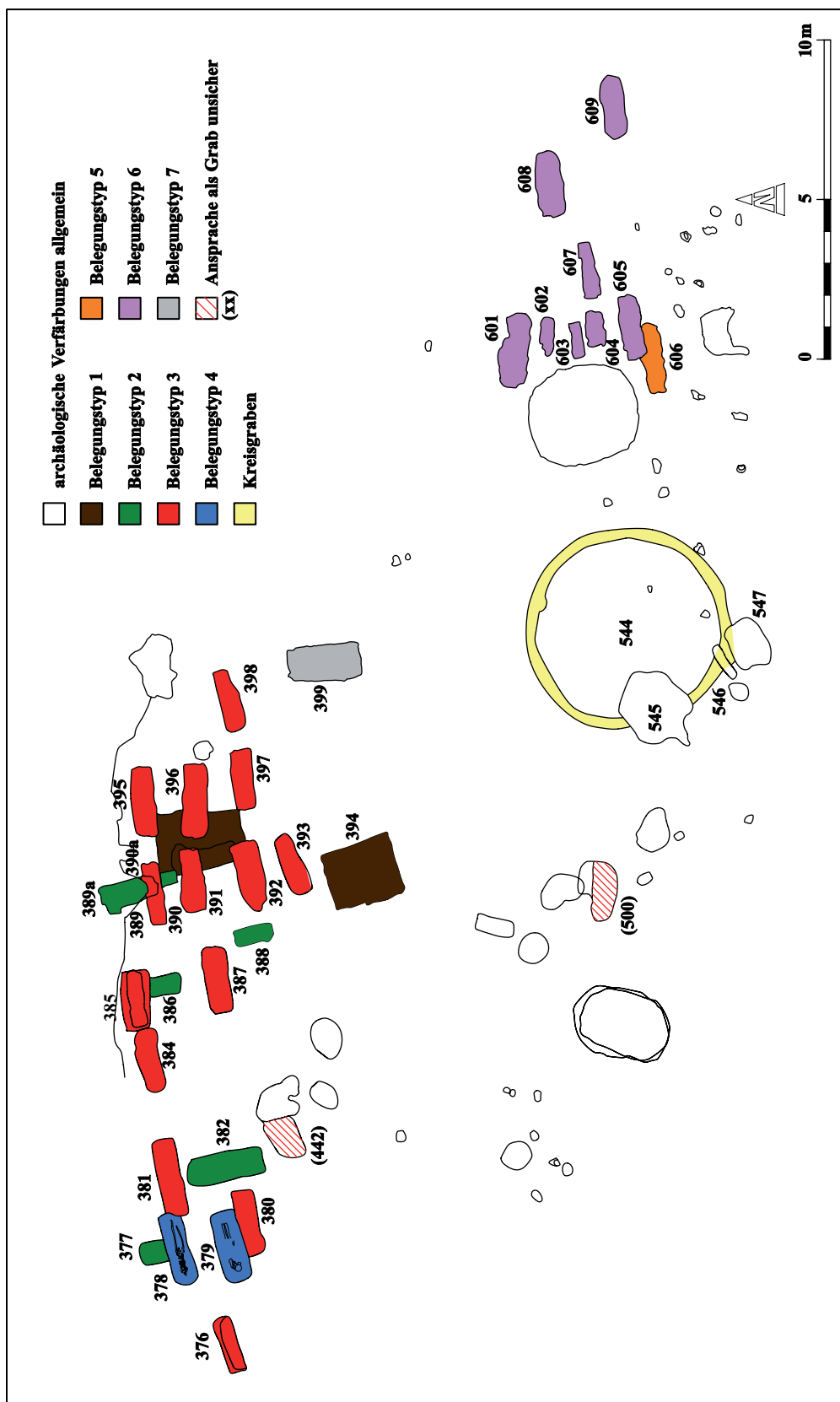

Ausschnitt aus dem Gesamtplan mit den Befunden des frühmittelalterlichen Gräberfelds. M 1:200.



Kammergrab 394

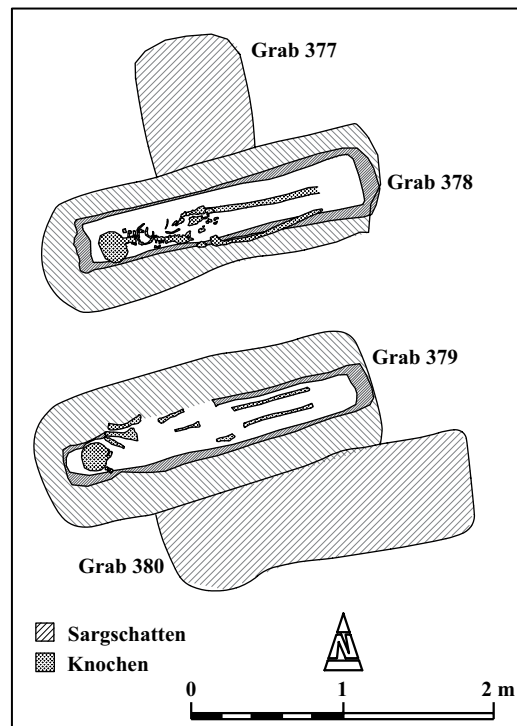

Frühmittelalterliche Körpergräber mit Skeletterhaltung

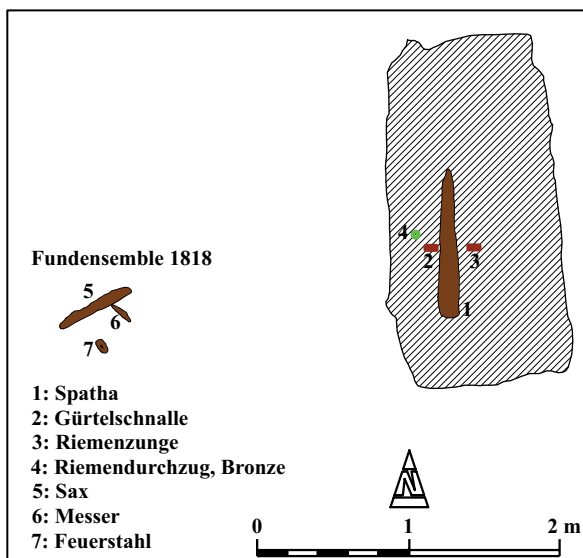

Grab 399

Frühmittelalterliche Gräber. M 1:50.

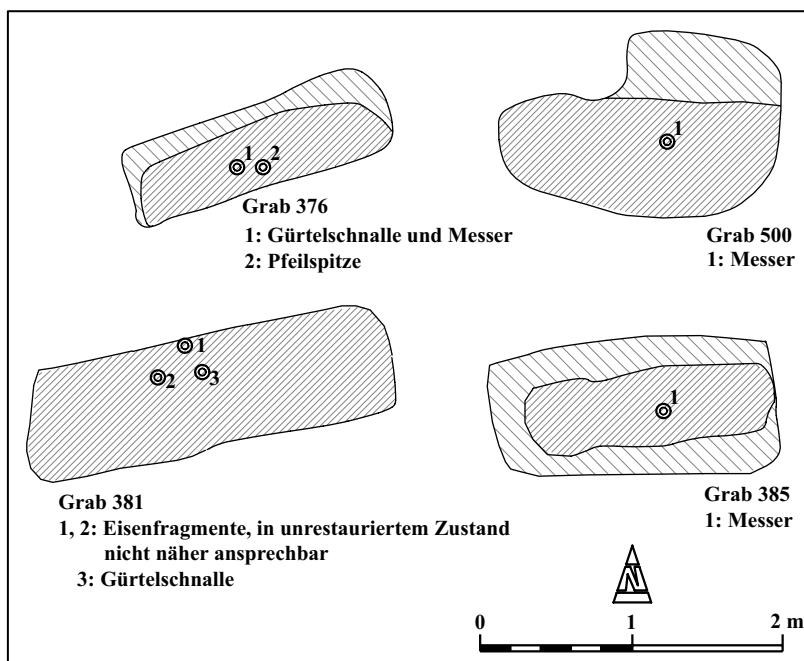
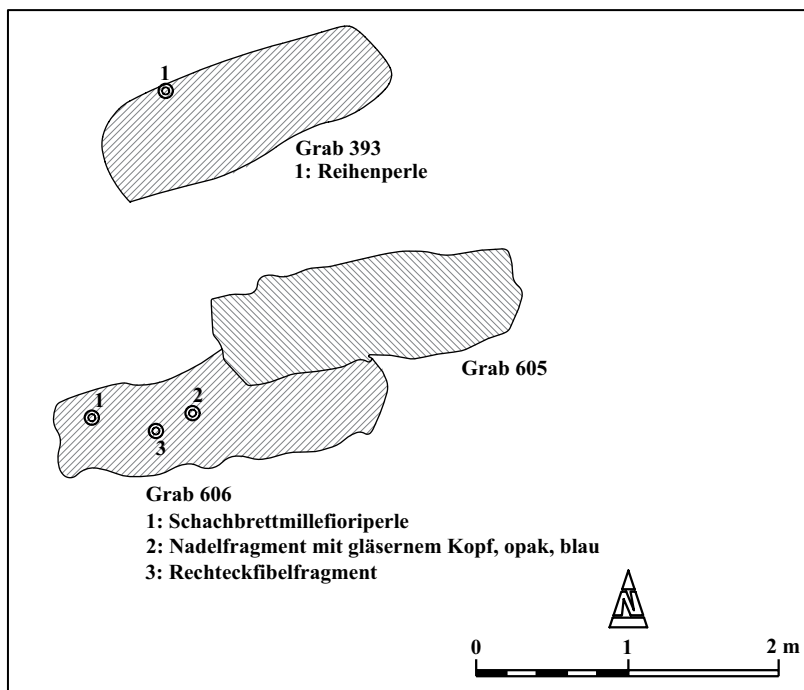

Lage der Beigaben/Trachtbestandteile in den frühmittelalterlichen Gräbern. M 1:50.

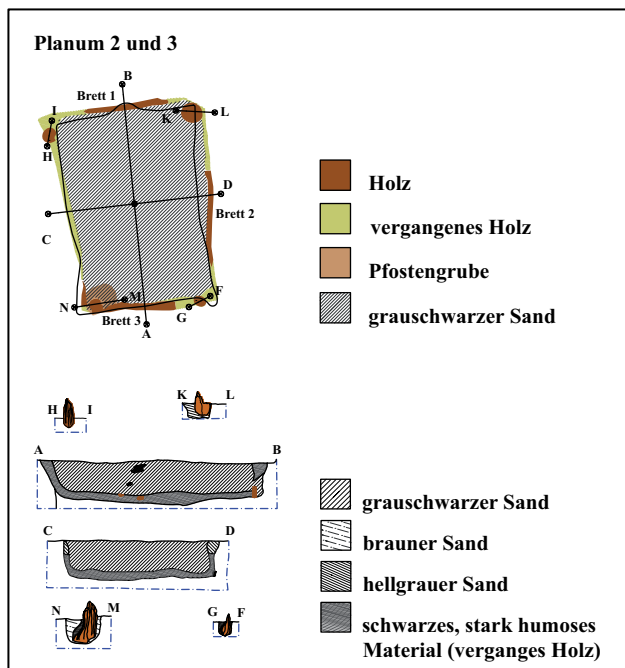

Grubenhaus 1129

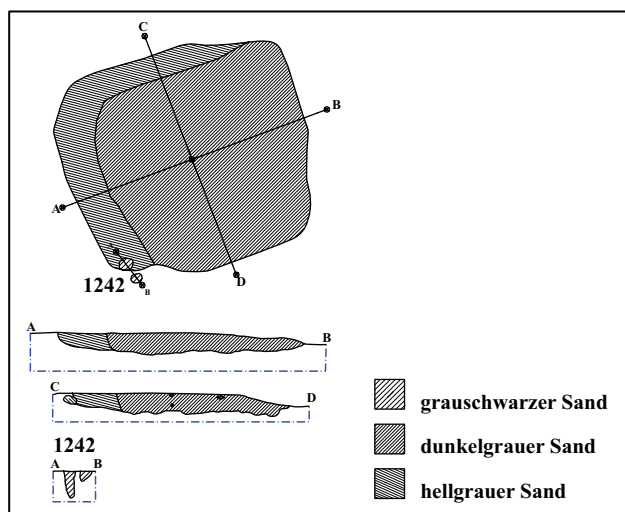

Grubenhaus 1243

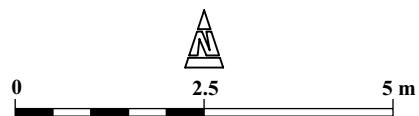

Hochmittelalterliches Grubenhaus 1129 und frühmittelalterliches Grubenhaus 1243. M 1:100.

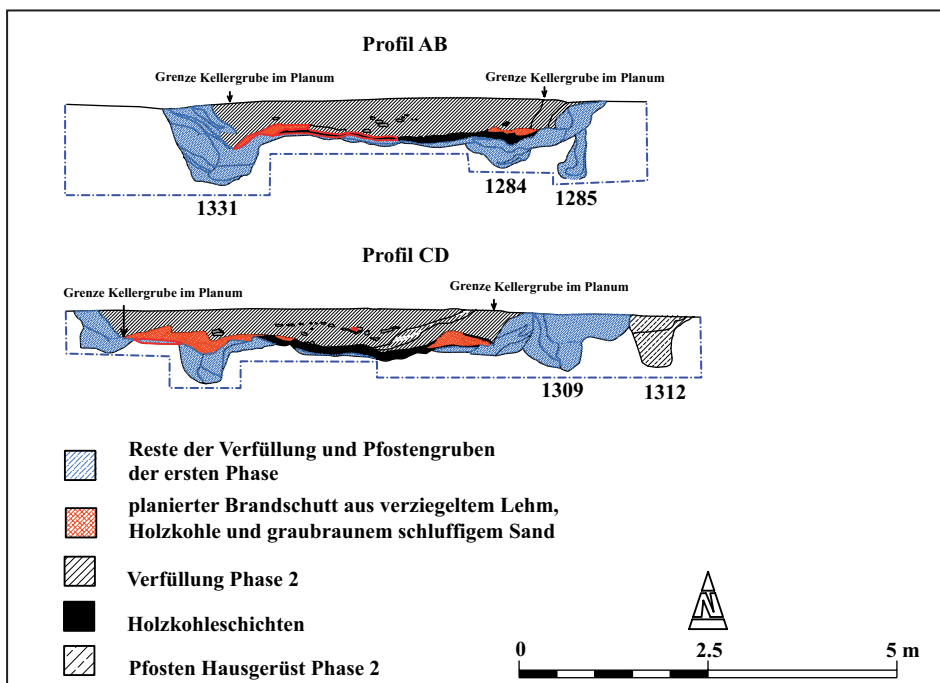
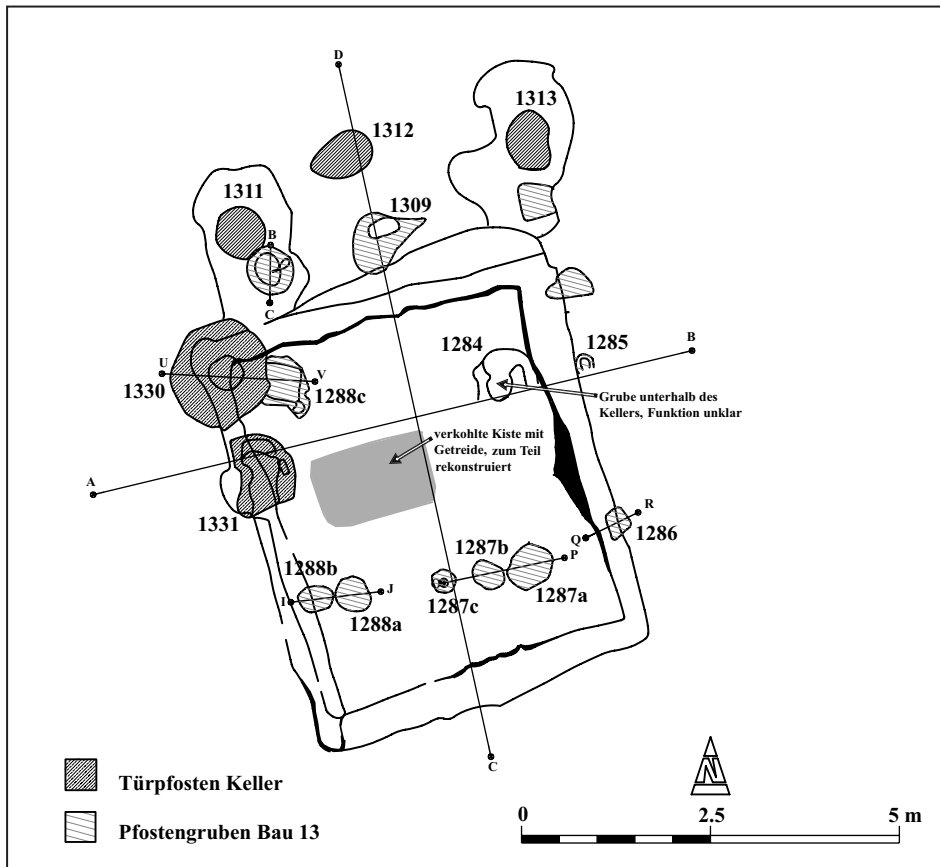

Hochmittelalterlicher Grubenkeller 1283 und Bau 13. M 1:100.

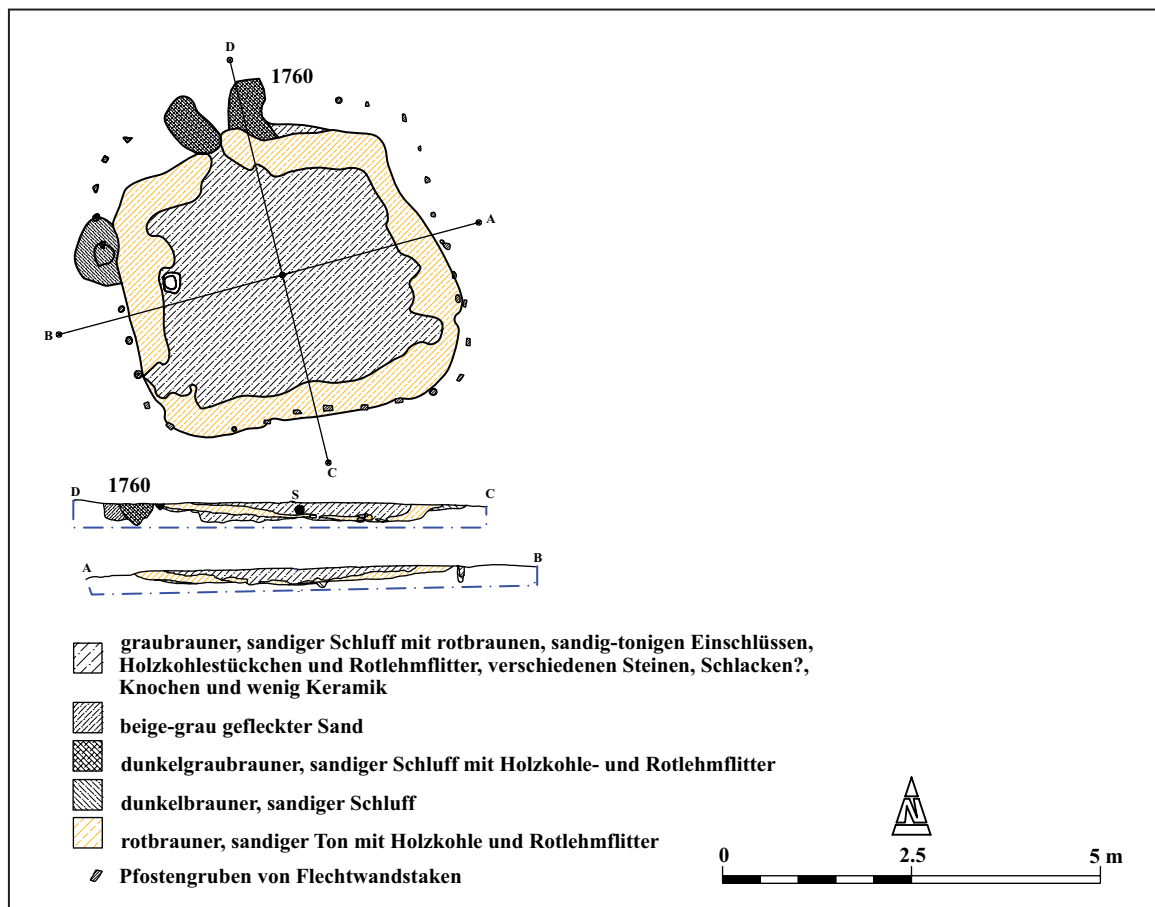

Hochmittelalterliches Grubenhaus 1759, 3. Planum. M 1:100.

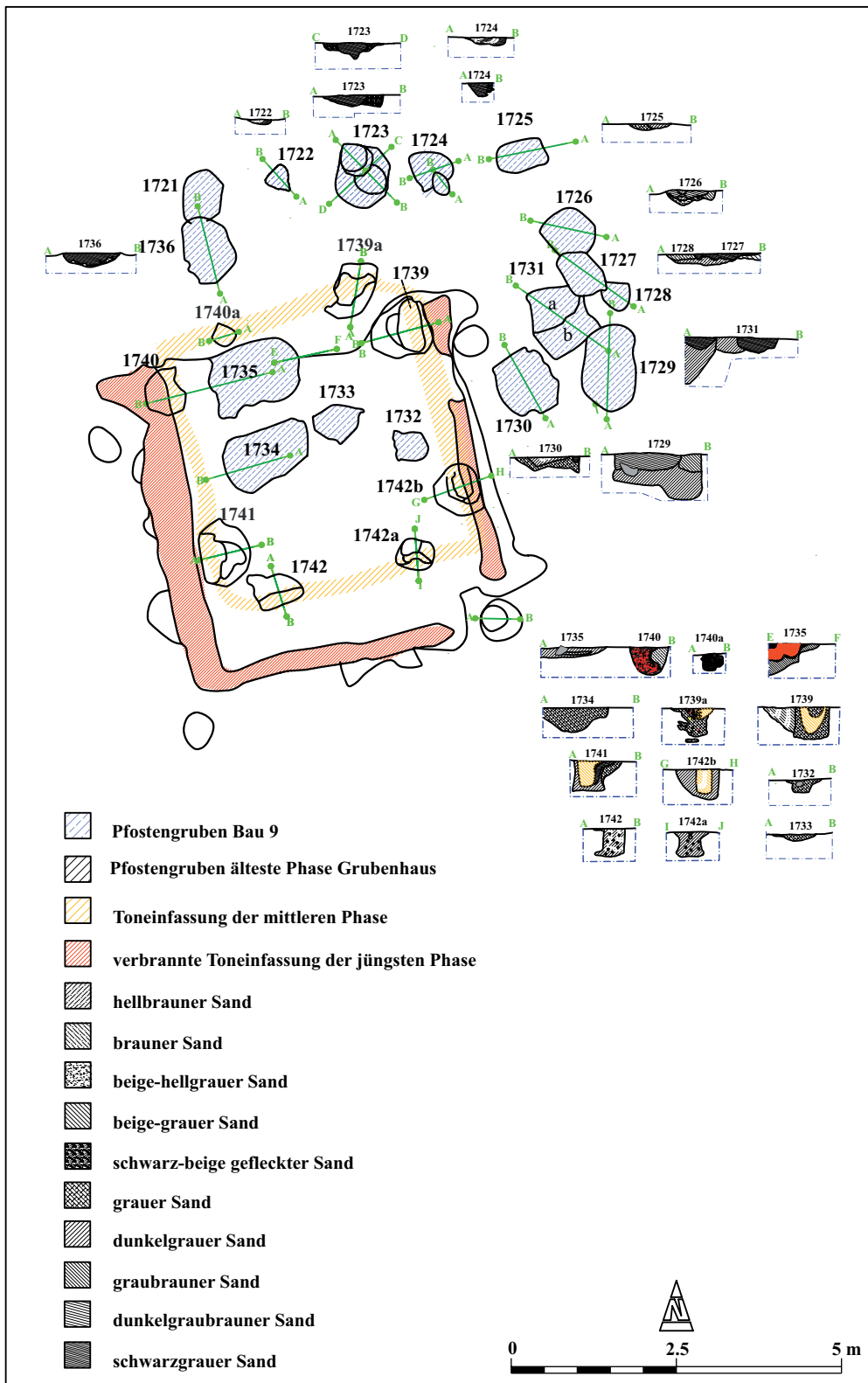

Die Pfostengruben der drei Phasen des hochmittelalterlichen Grubenhauses 1738 und des Kleinbau 9. M 1:100.

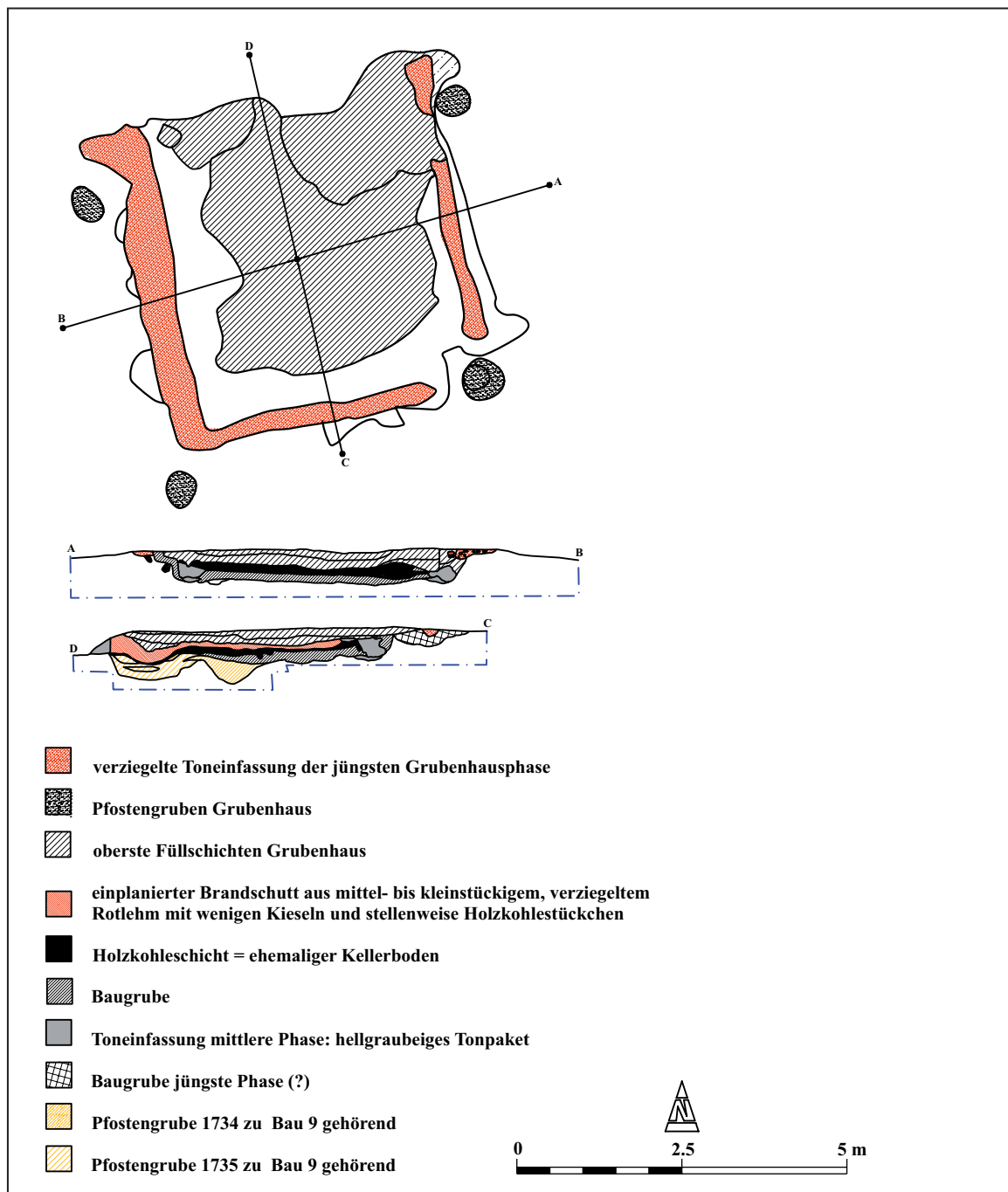

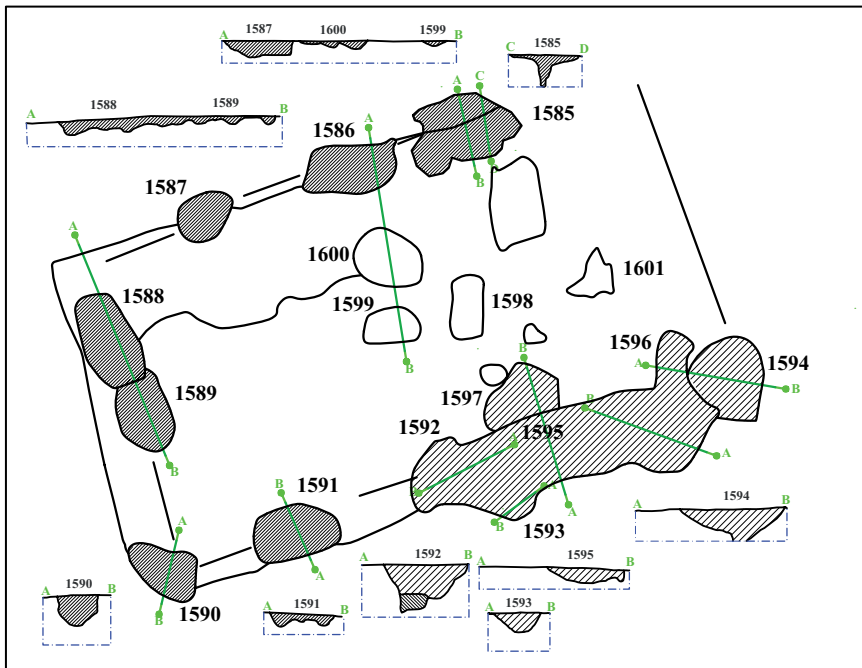

Hochmittelalterliches Grubenhaus 1738, jüngste Phase. M 1:100.

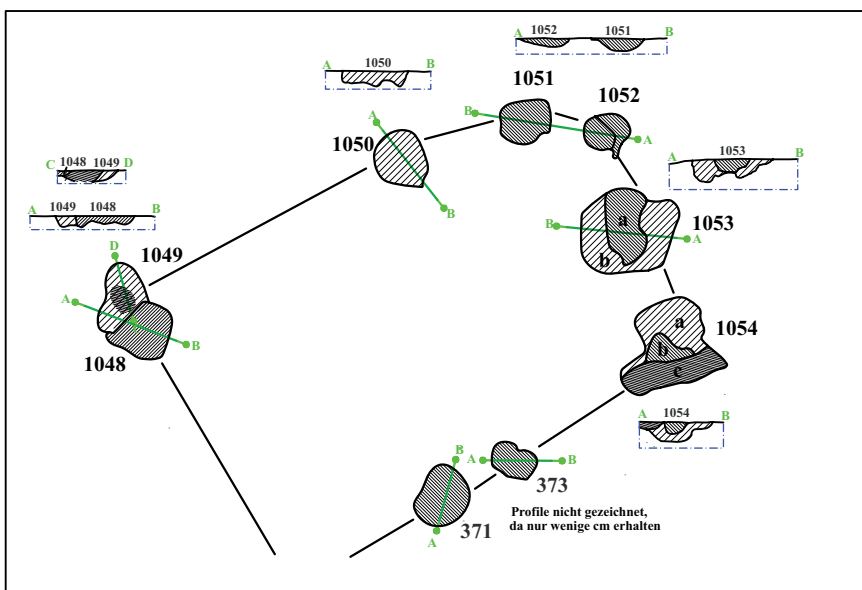

Bau 8



Bau 10

-  grauer Sand
-  hellgrauer Sand
-  dunkelgrauer Sand

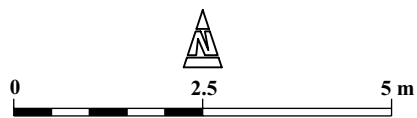



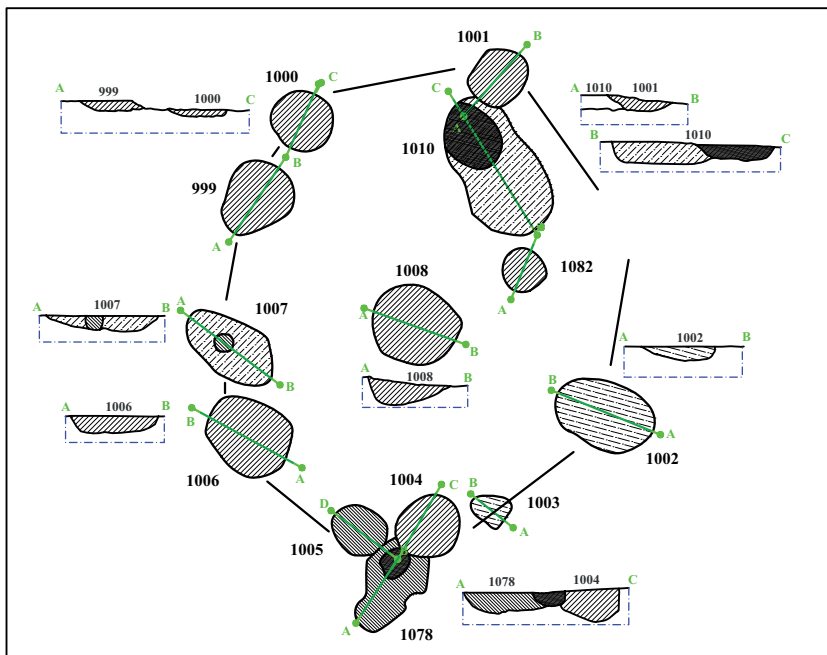

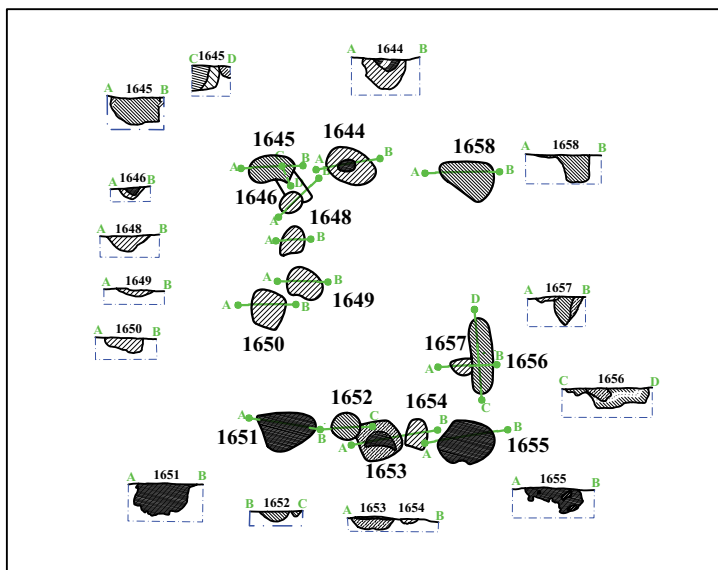

Hochmittelalterliche Kleinbauten 8 und 10. M 1:100.



Bau 11



Bau 12

-  brauner Sand
-  ocker-grau gefleckter Sand
-  hellgrauer Sand
-  grauer Sand
-  dunkelgrauer Sand
-  schwarzgrauer Sand

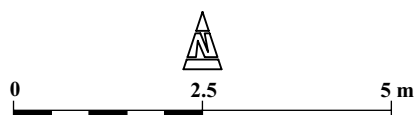

Hochmittelalterliche Kleinbauten 11 und 12. M 1:100.

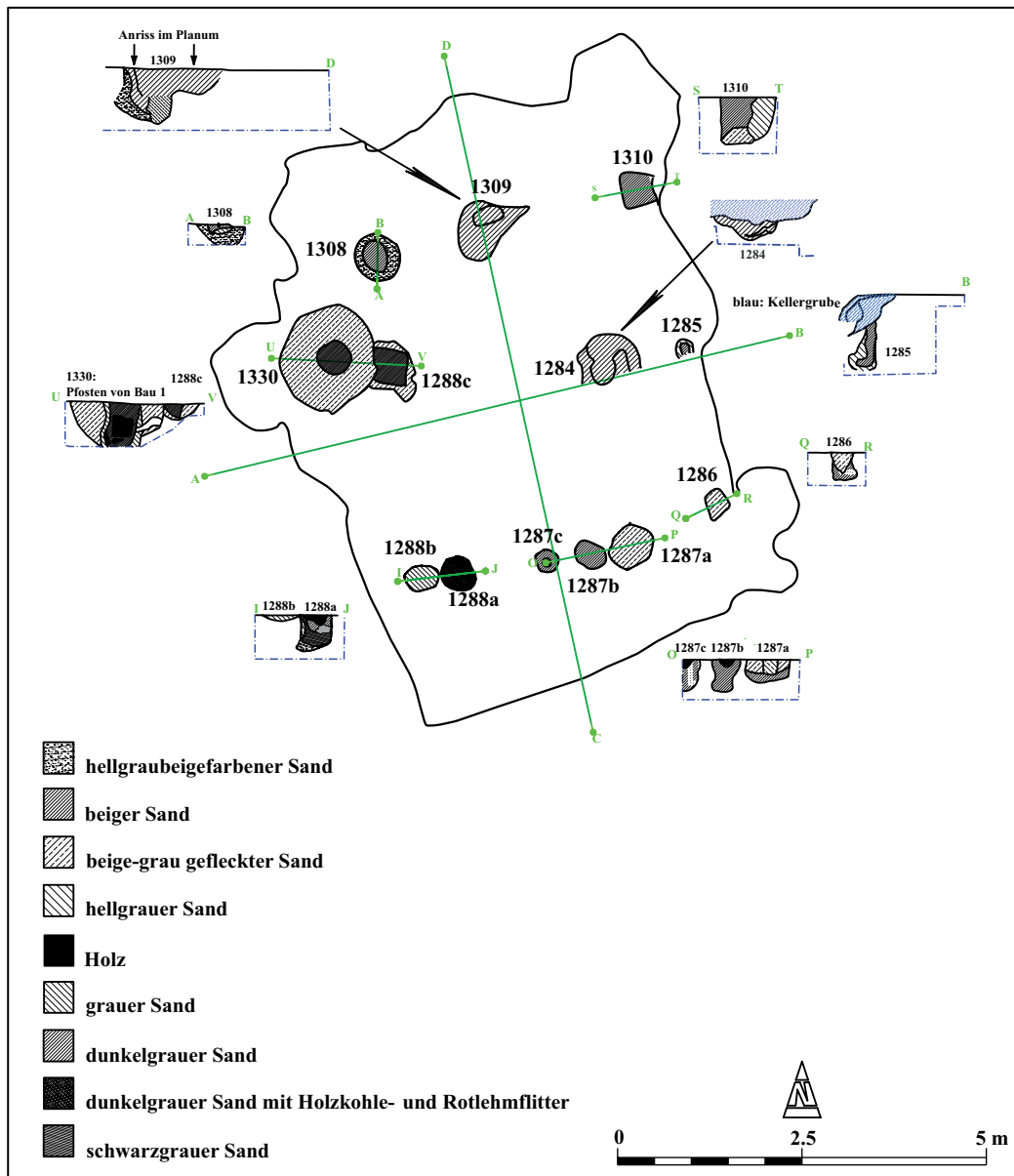

Pfostengruben der älteren Kellerphase des hochmittelalterlichen Kleinbaus 13. M 1:100.

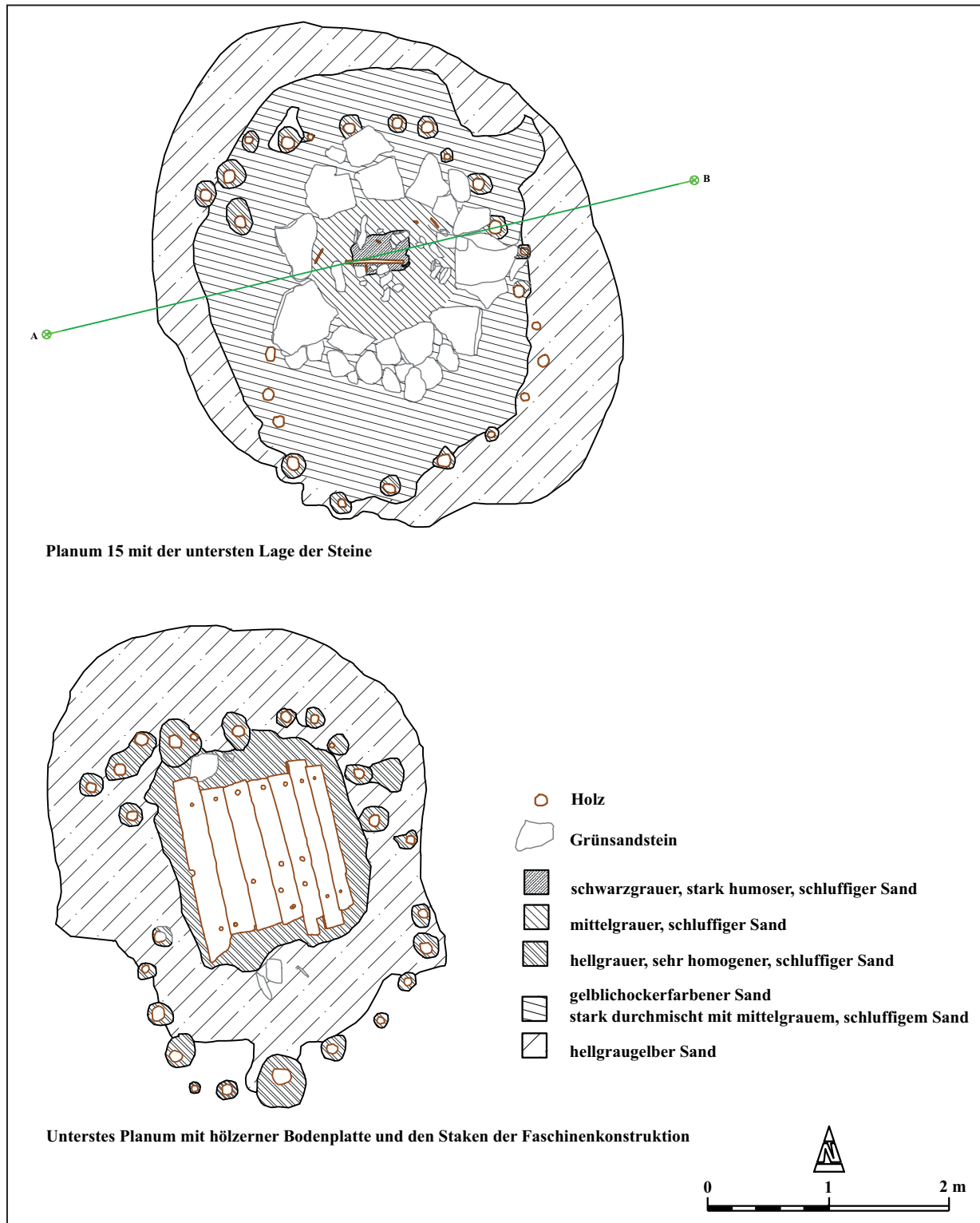

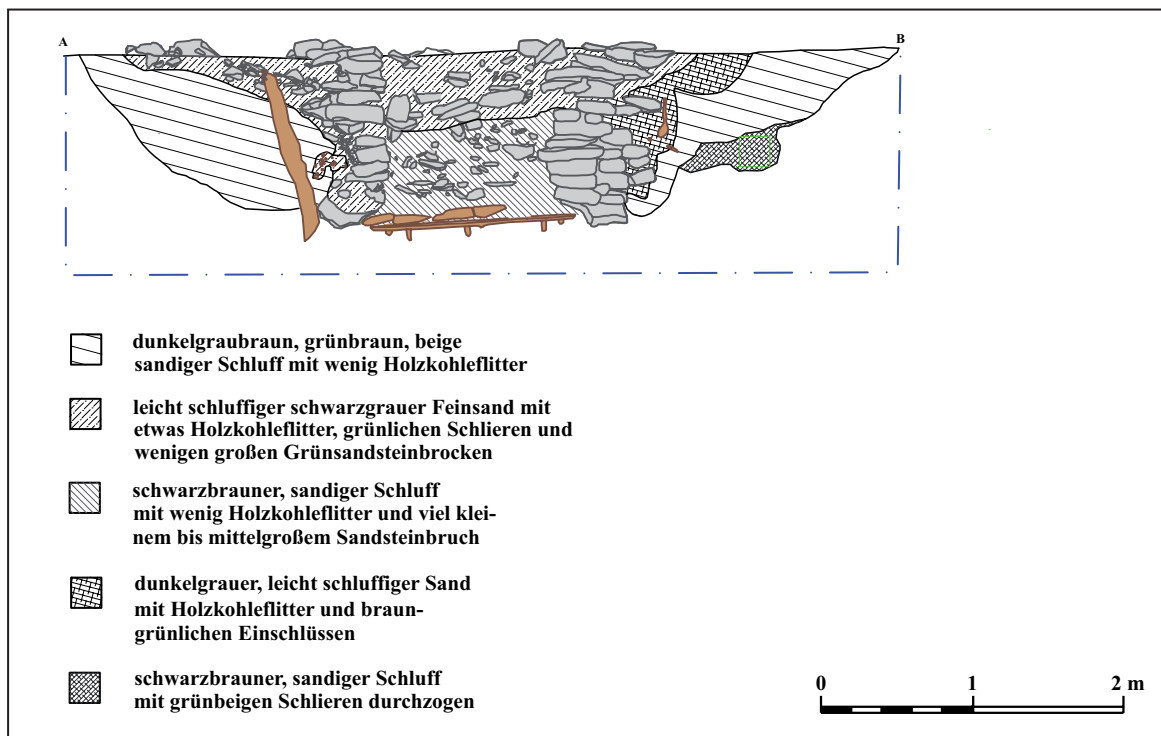

Hochmittelalterlicher Brunnen 1753, Profil. M 1:50.

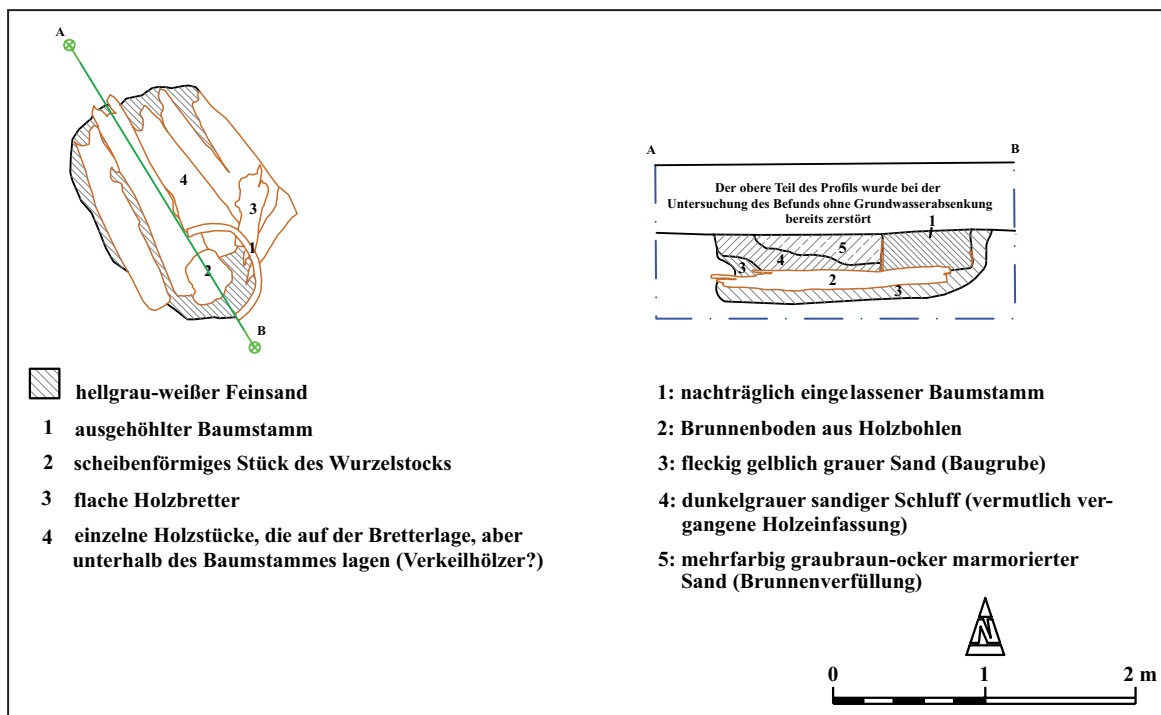

Hochmittelalterlicher Brunnen 1806. M 1:50.