

XVI Fundtafeln

Die Abbildungsnummern auf den Tafeln entsprechen den Objektnummern im Katalog.

Die Zeichnungen sind, sofern nicht anders angegeben, im Maßstab 1/2 publiziert.

Besondere Darstellungsweisen sind durch folgende nebenstehende Buchstabenkürzel gekennzeichnet:

B = Zeichnung der Objekte in Fundlage

R = Umzeichnung eines Röntgenbildes

B/R = Kombination einer Zeichnung von Objekten in Befundlage und einem Röntgenbild

T = technische Zeichnung bzw. Rekonstruktionszeichnung

V = Zeichnungen verschiedener Restaurierungszustände

Die Perlen sind im Maßstab 2/3 publiziert.

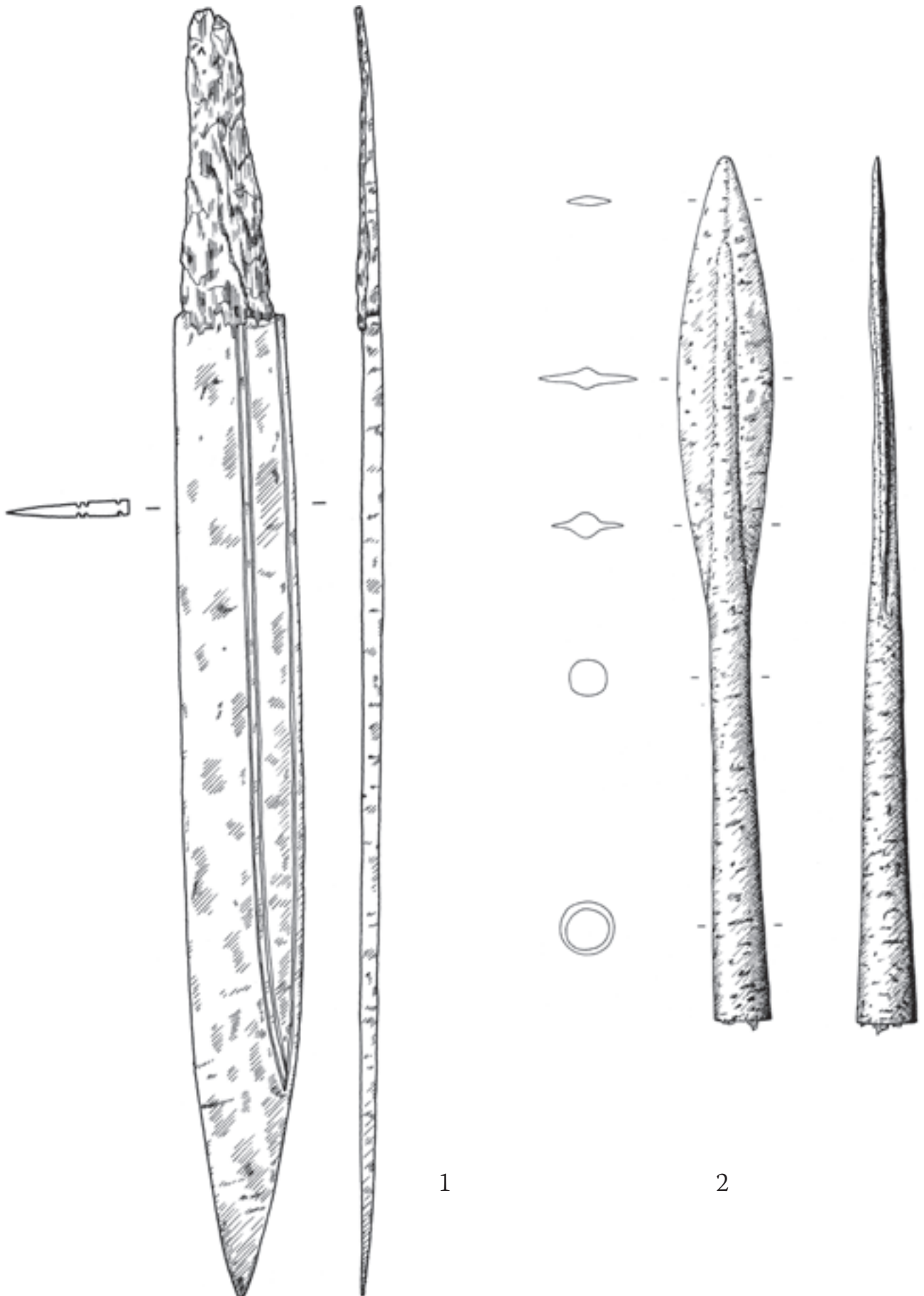

1

2

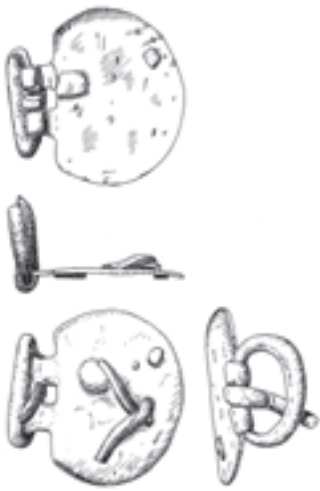

3

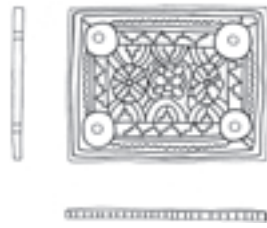

4



5



6

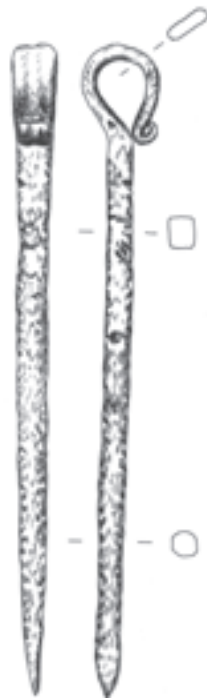

7

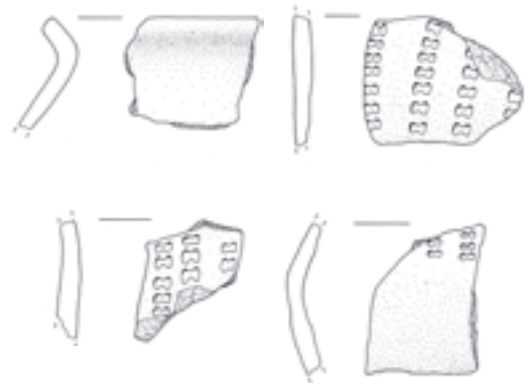

8



9

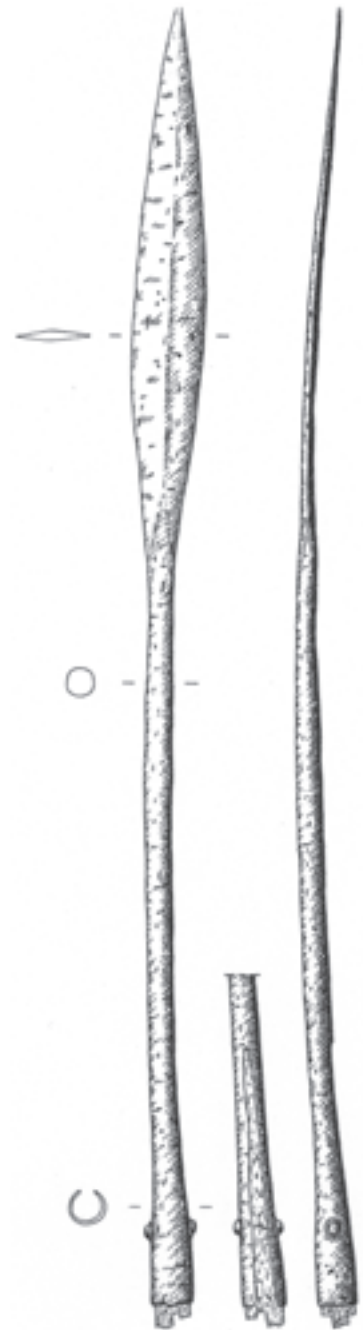
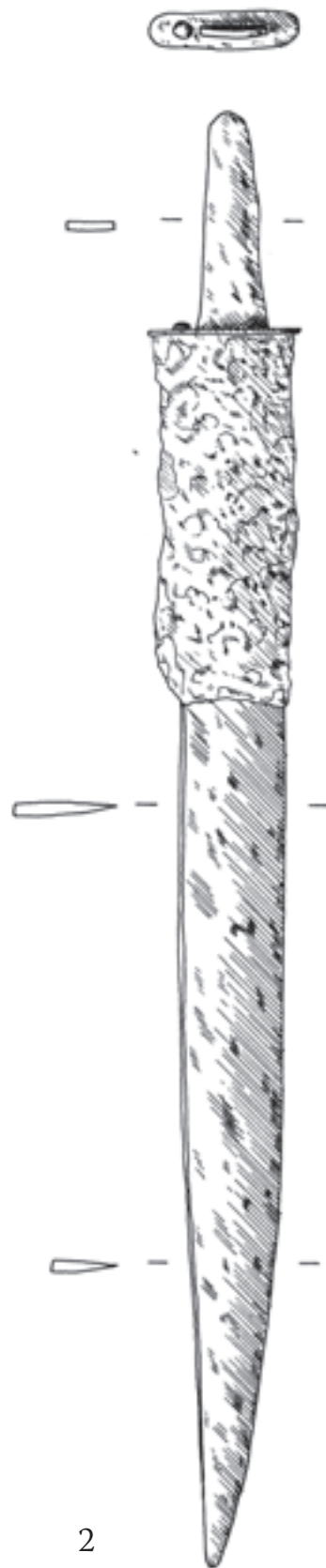
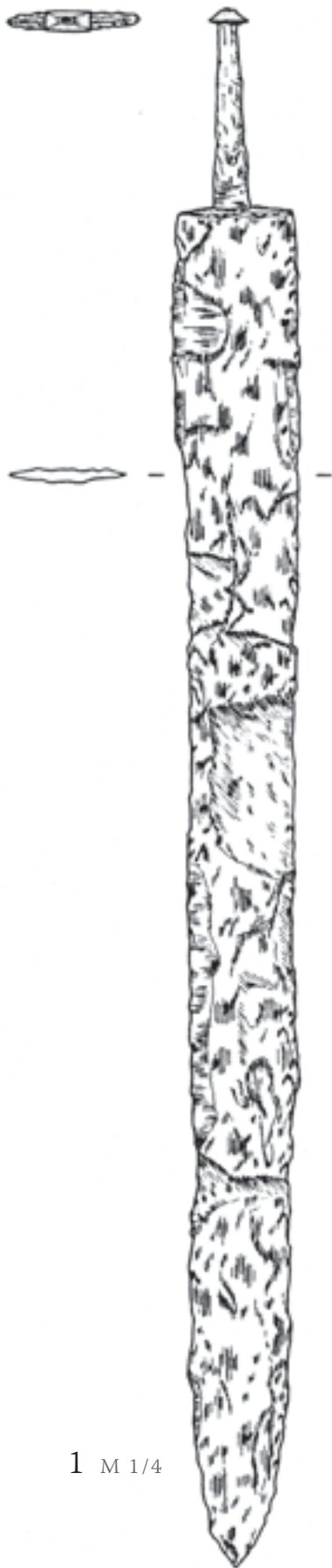

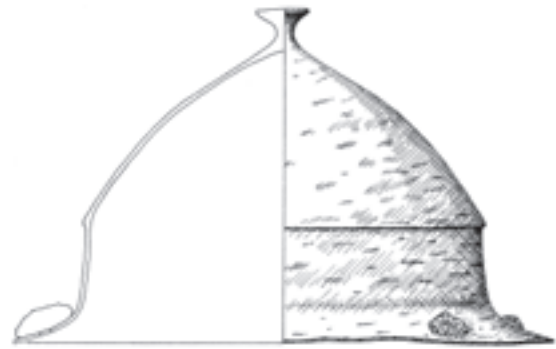
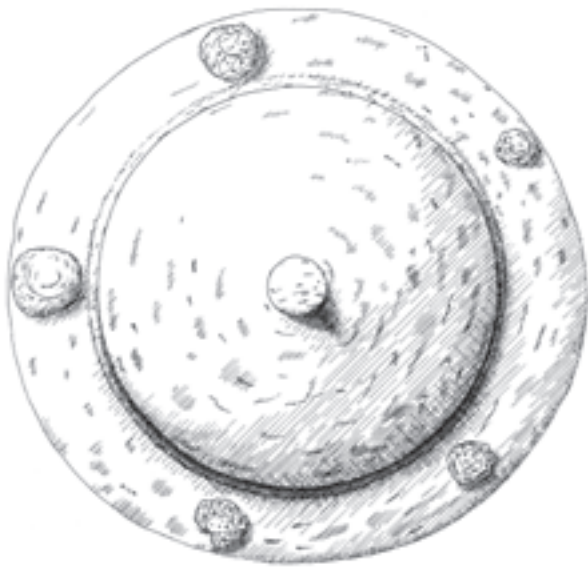

4a

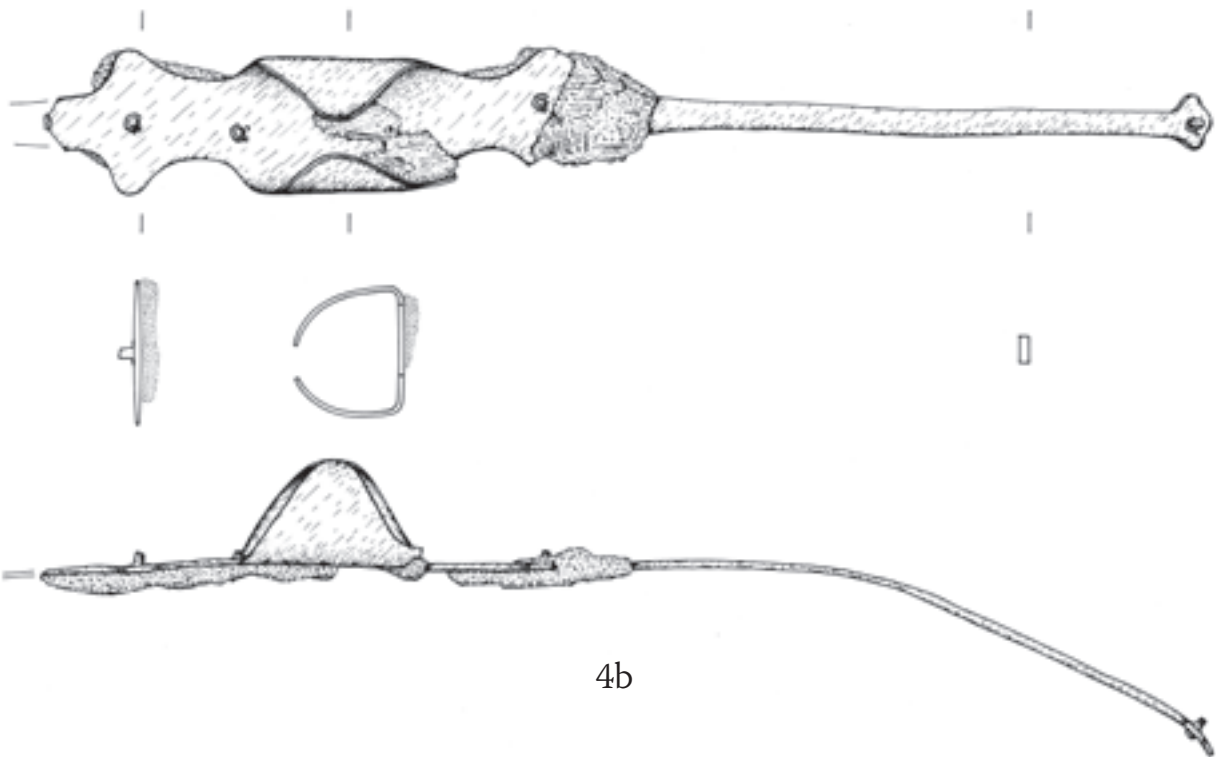

4b



4c



5 (R)

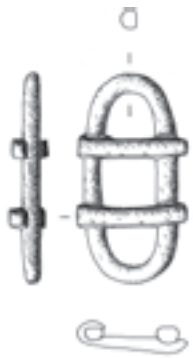

6



8

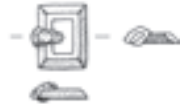

9

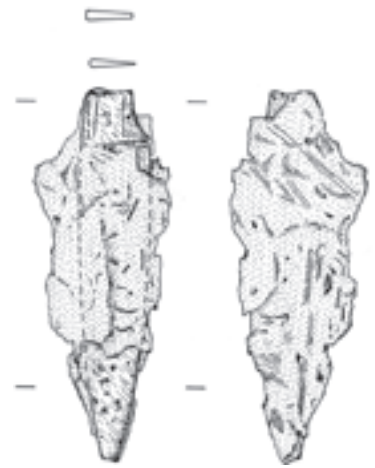

10



11



12a

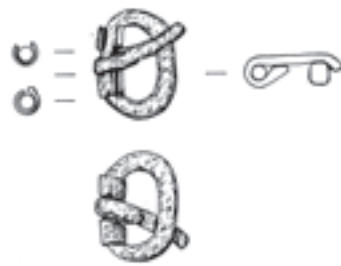

12d

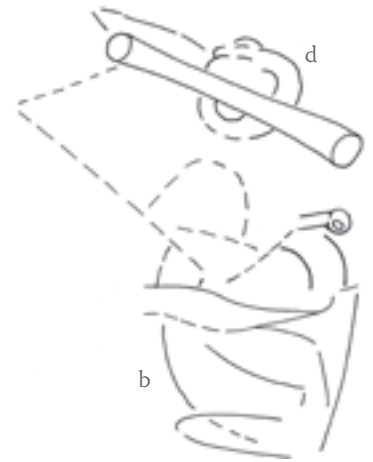

12(R)

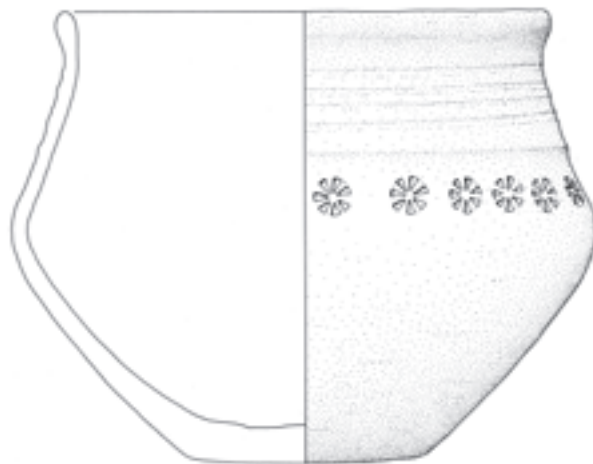

13

Grab St 12

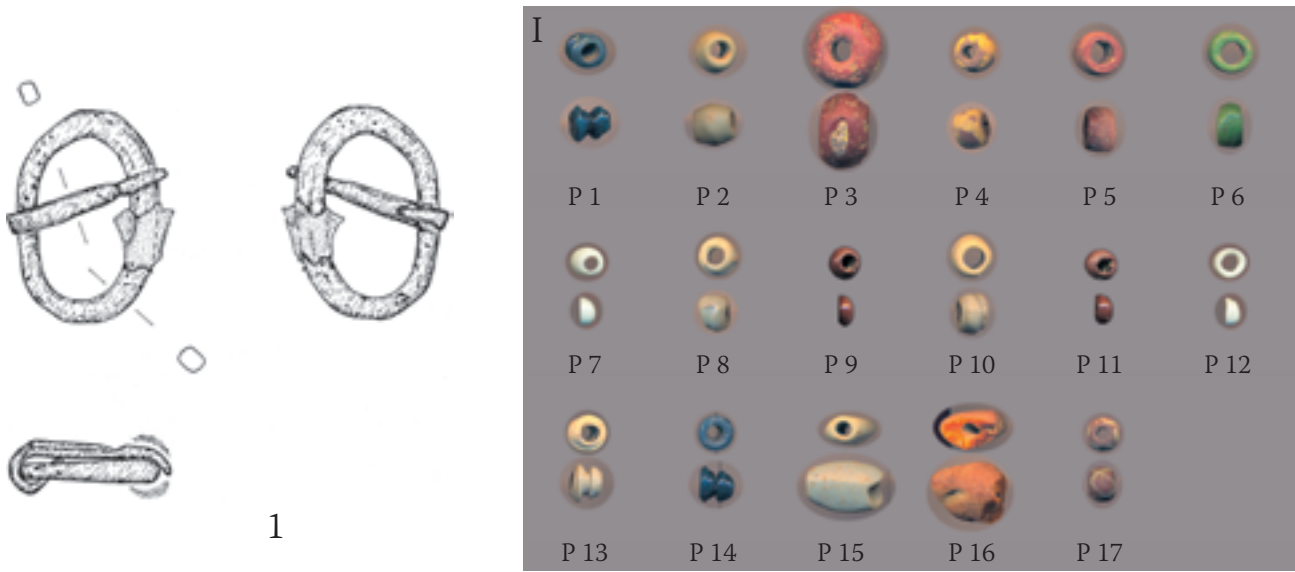

Grab St 18

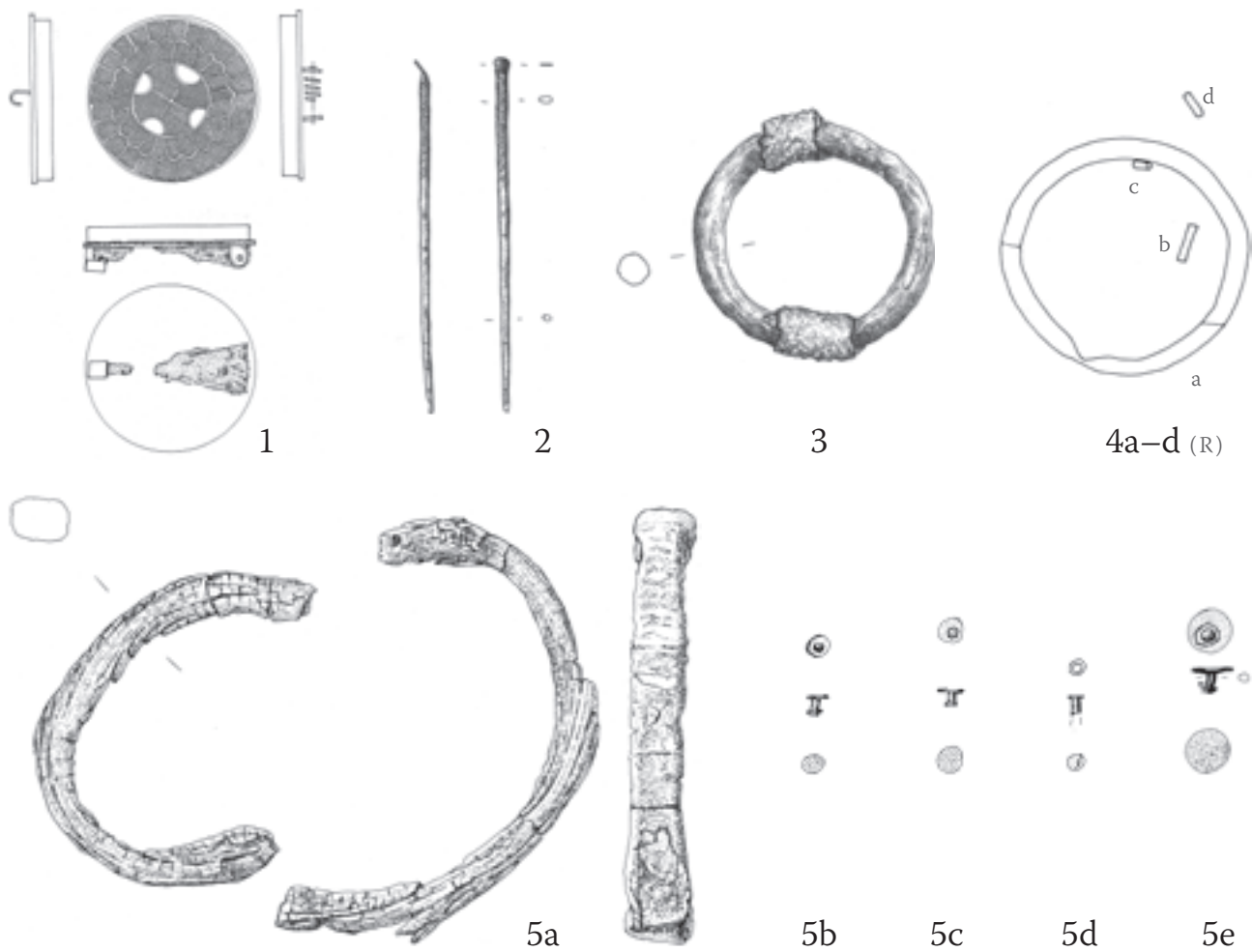



6

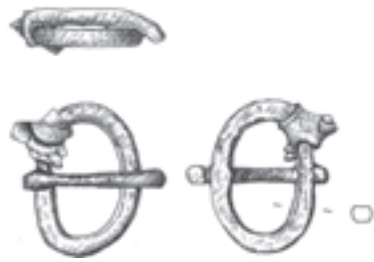

7



8



9

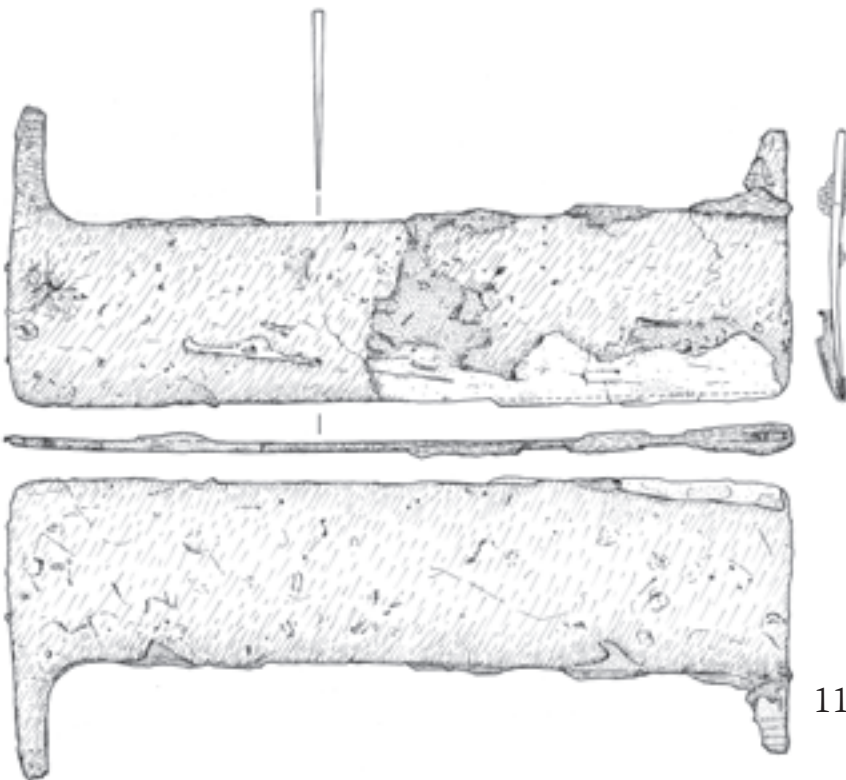

11a



10



11b

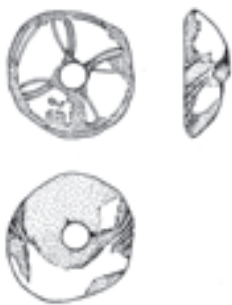

12



13



14



15

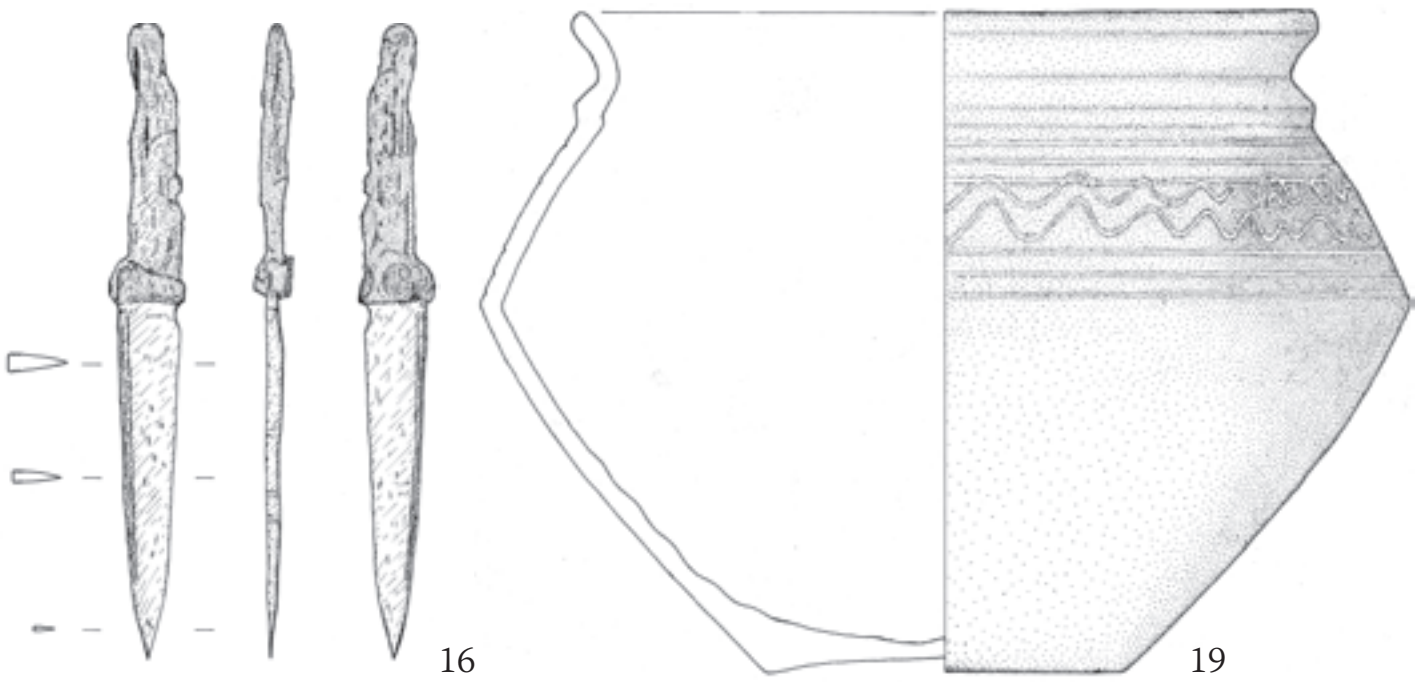

16

19

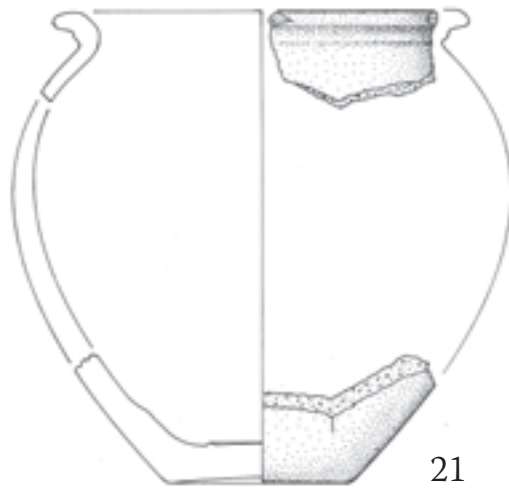

21

I-XI

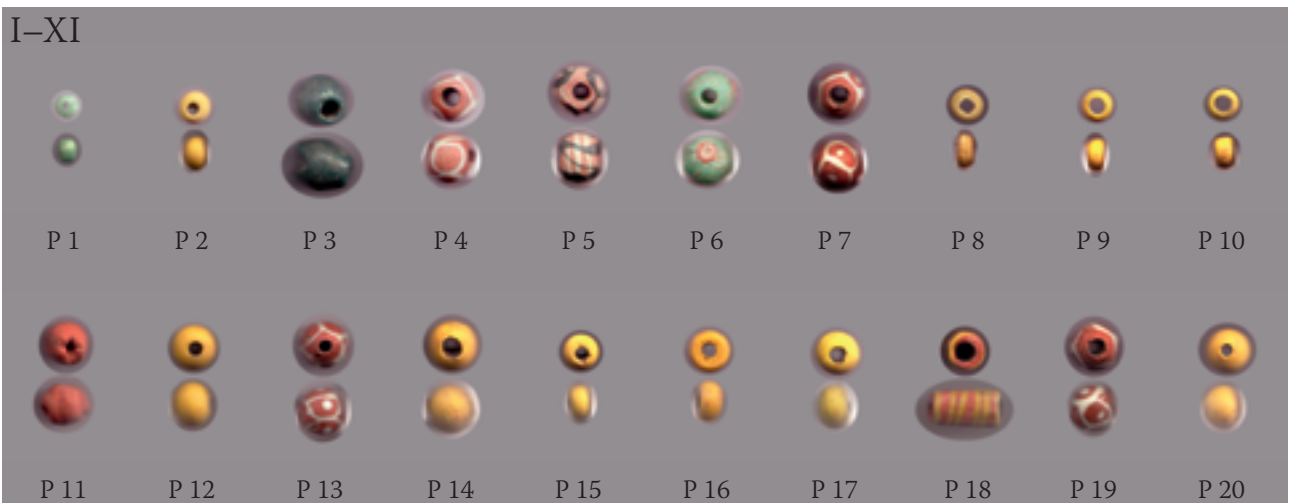

P 1

P 2

P 3

P 4

P 5

P 6

P 7

P 8

P 9

P 10

P 11

P 12

P 13

P 14

P 15

P 16

P 17

P 18

P 19

P 20

TAFEL 9

I–XI



I-XI



I–XI

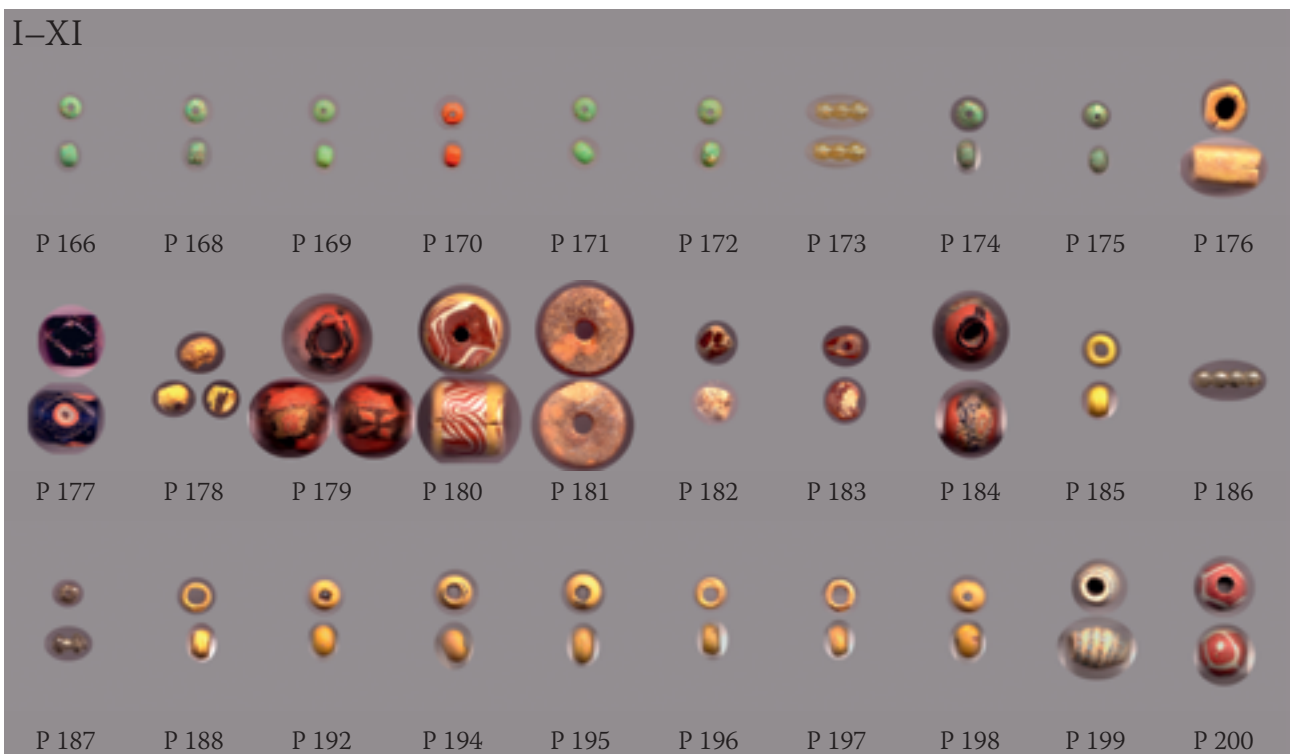

Grab St 19

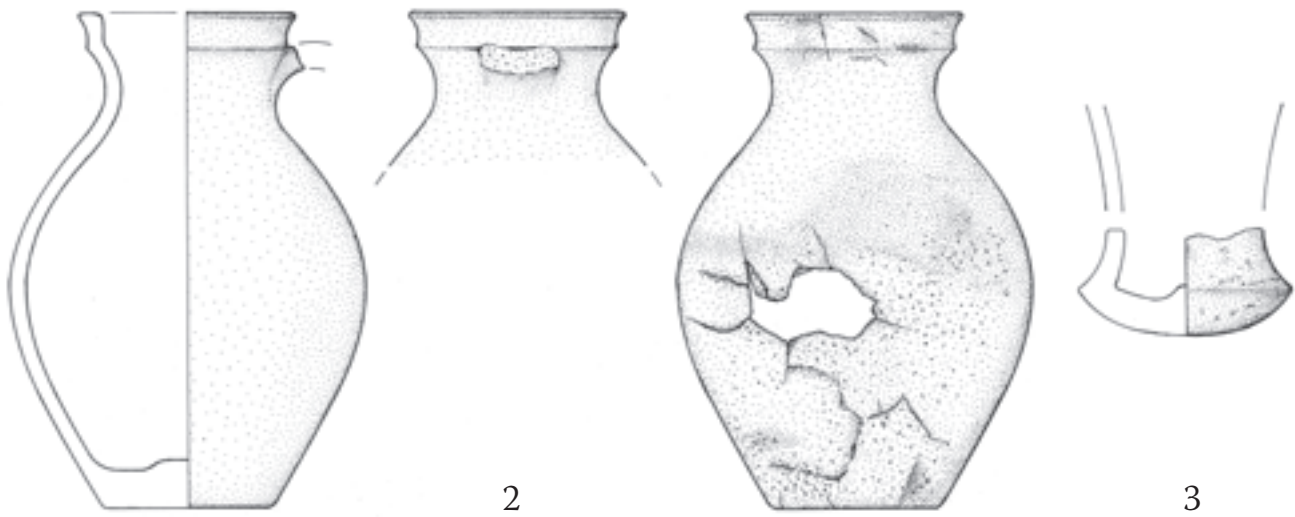

I-III



Grab St 20



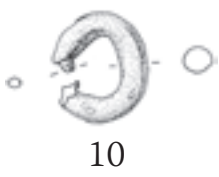
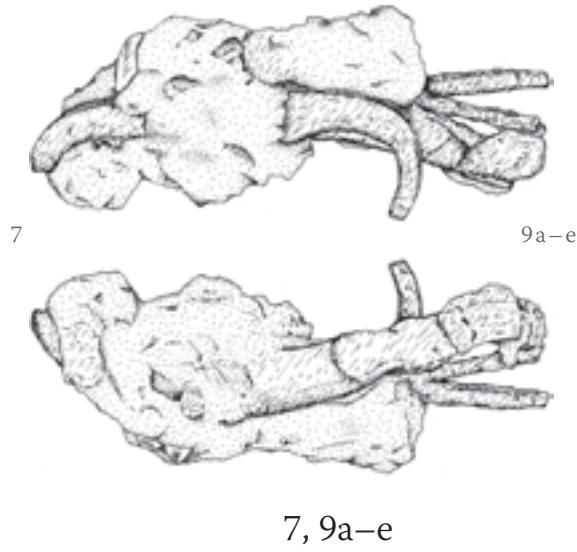
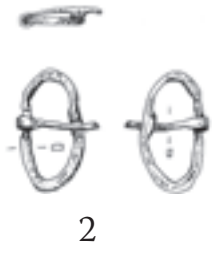

Grab St 21

I-III



Grab St 23

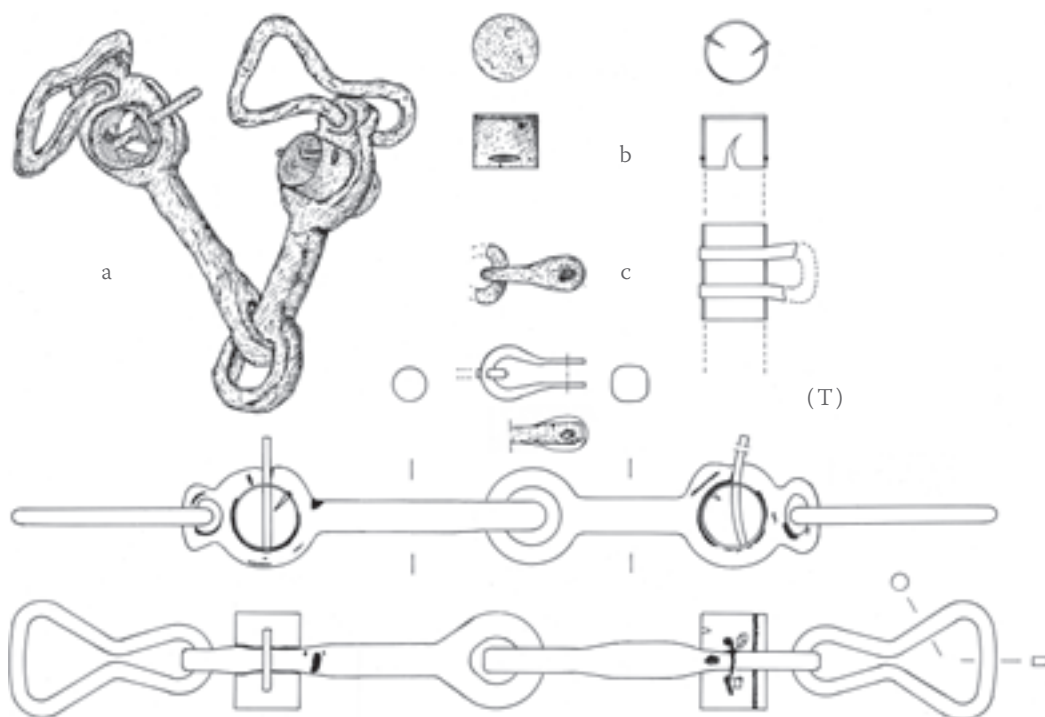

1a-c

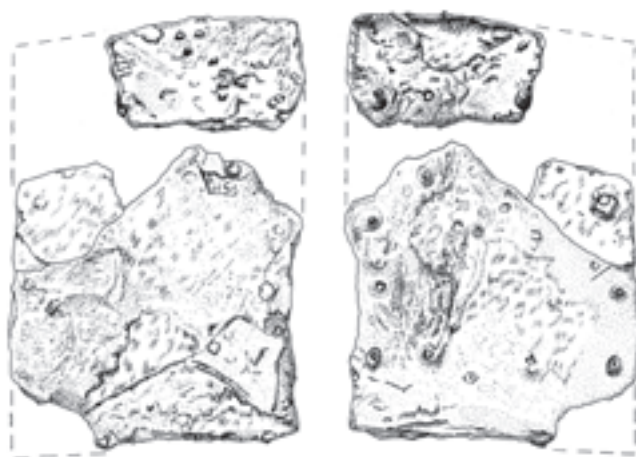

2a



2b



2c



2d



2e



2f



2g

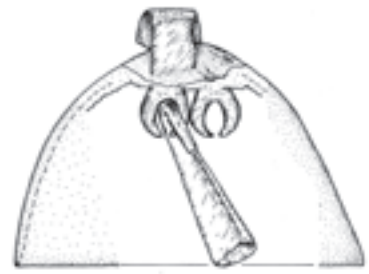

2h



2i

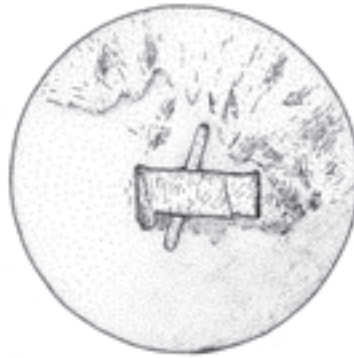

3



4



5



6



7



8



9



10

Grab St 26

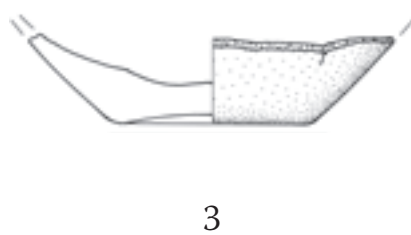
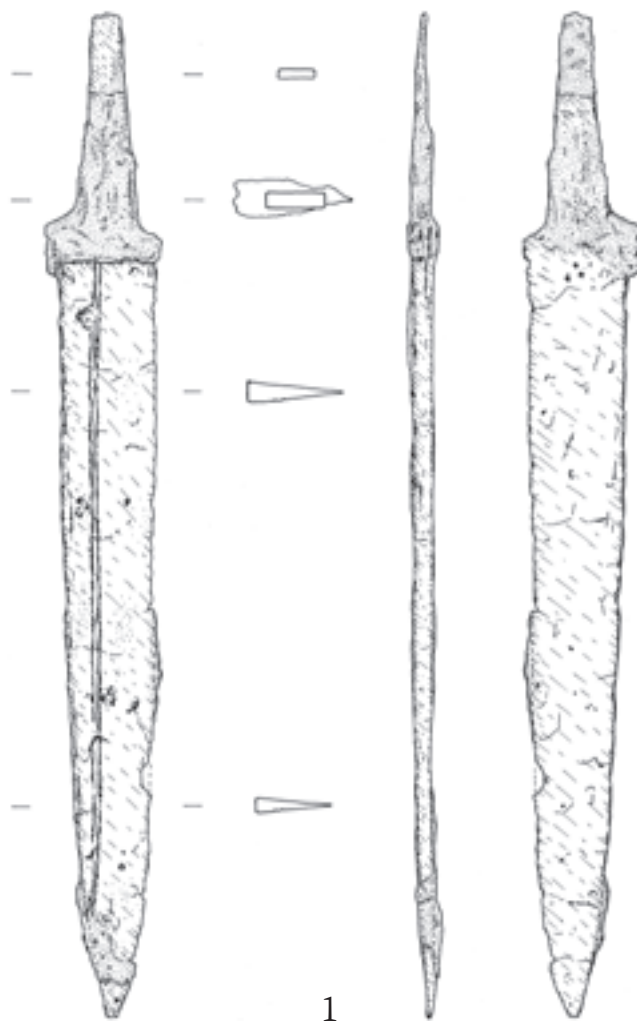

I-IV



P 1

P 2

P 3

P 4

P 6

P 7

P 8

P 9

P 10

Grab St 36

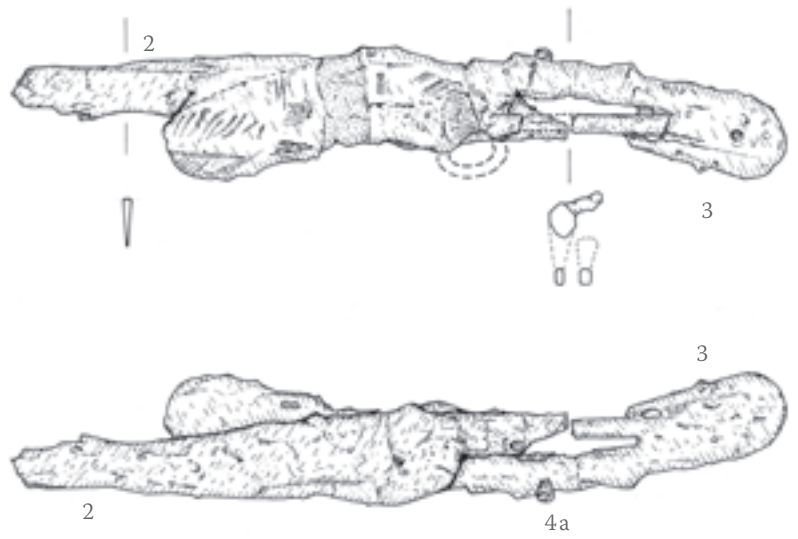

2, 3, 4a

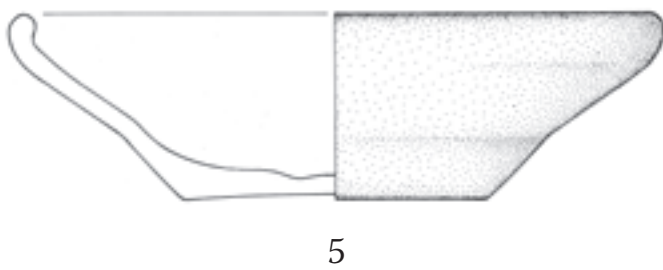
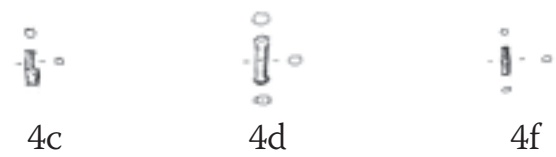

Grab St 169

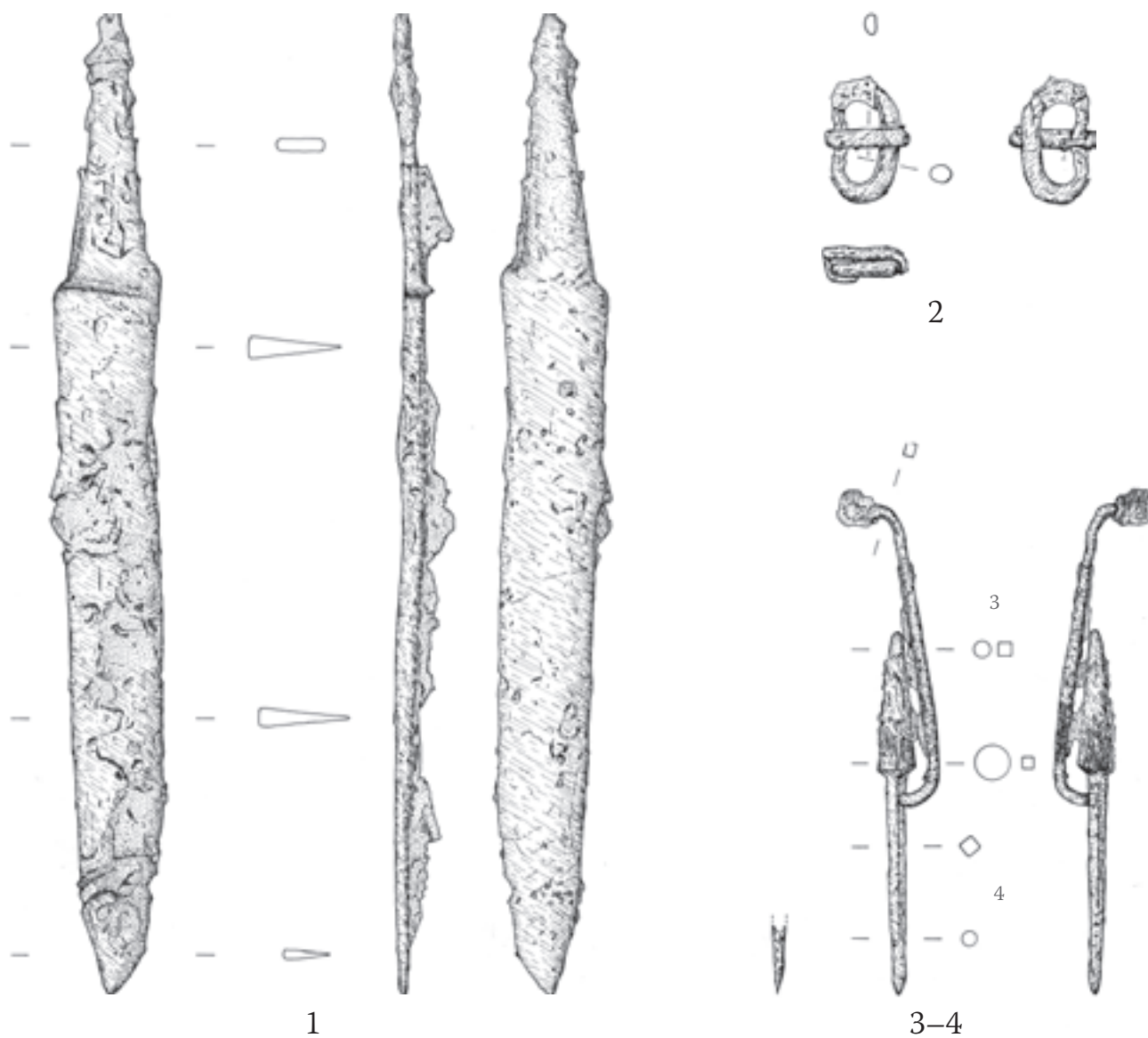

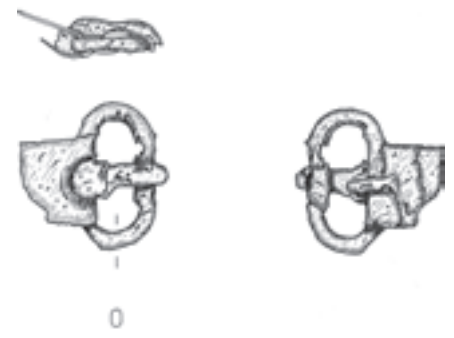

2



3



4



5

Grab St 172



1



2 (v)



3

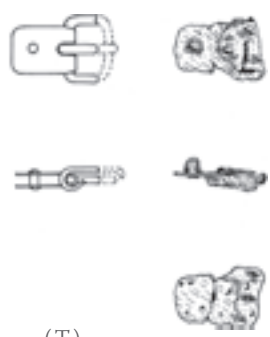

(T)

4

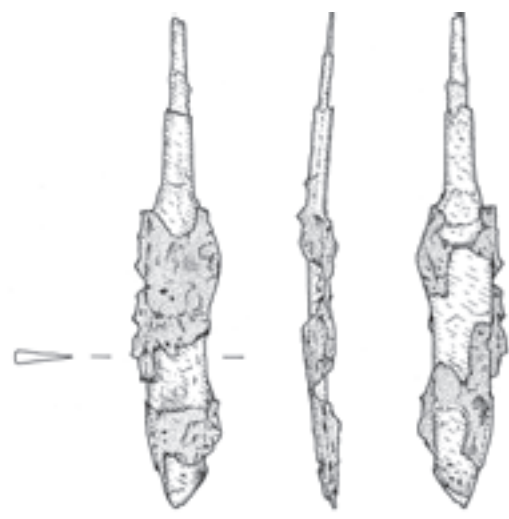

5



6a-d

I-II



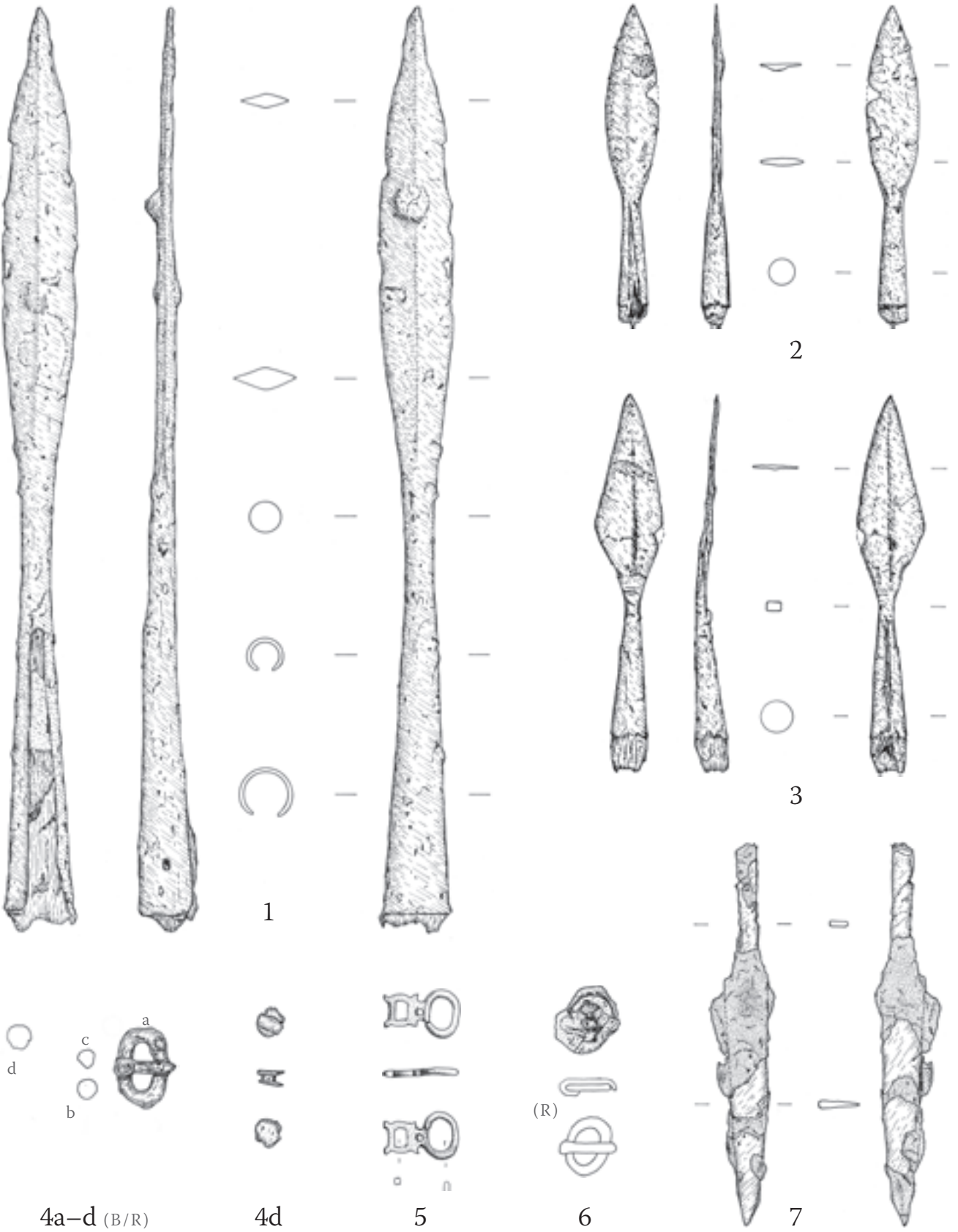

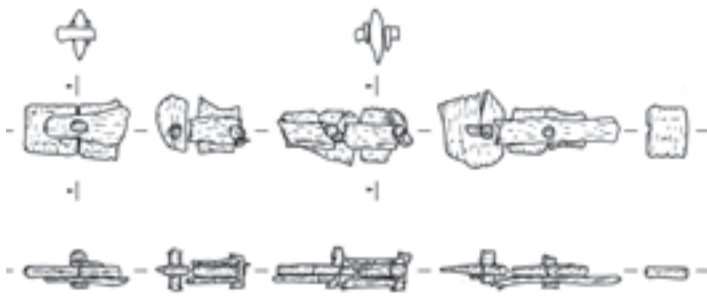

8



10 M 1/1

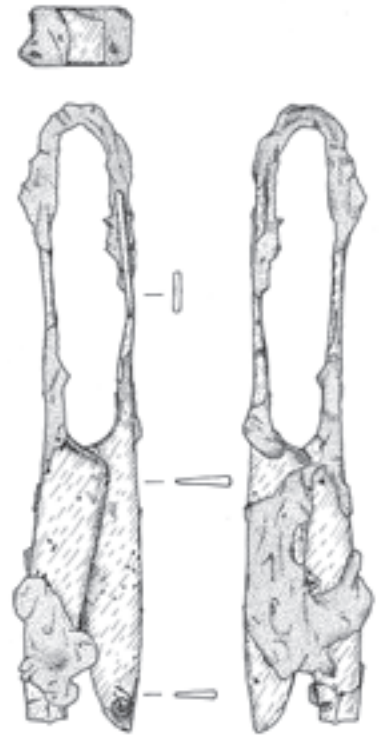

9



11

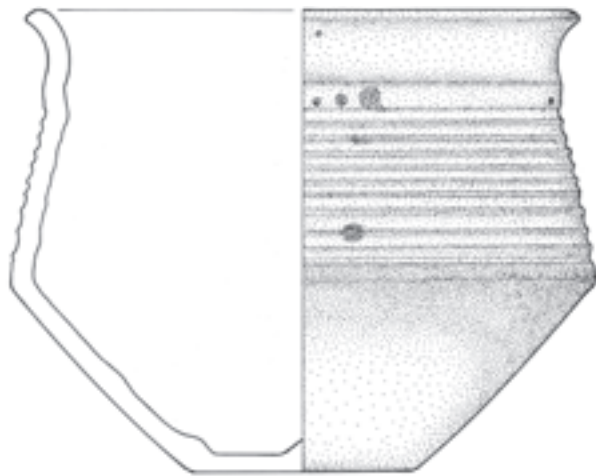

12



13



14



15

Grab St 174

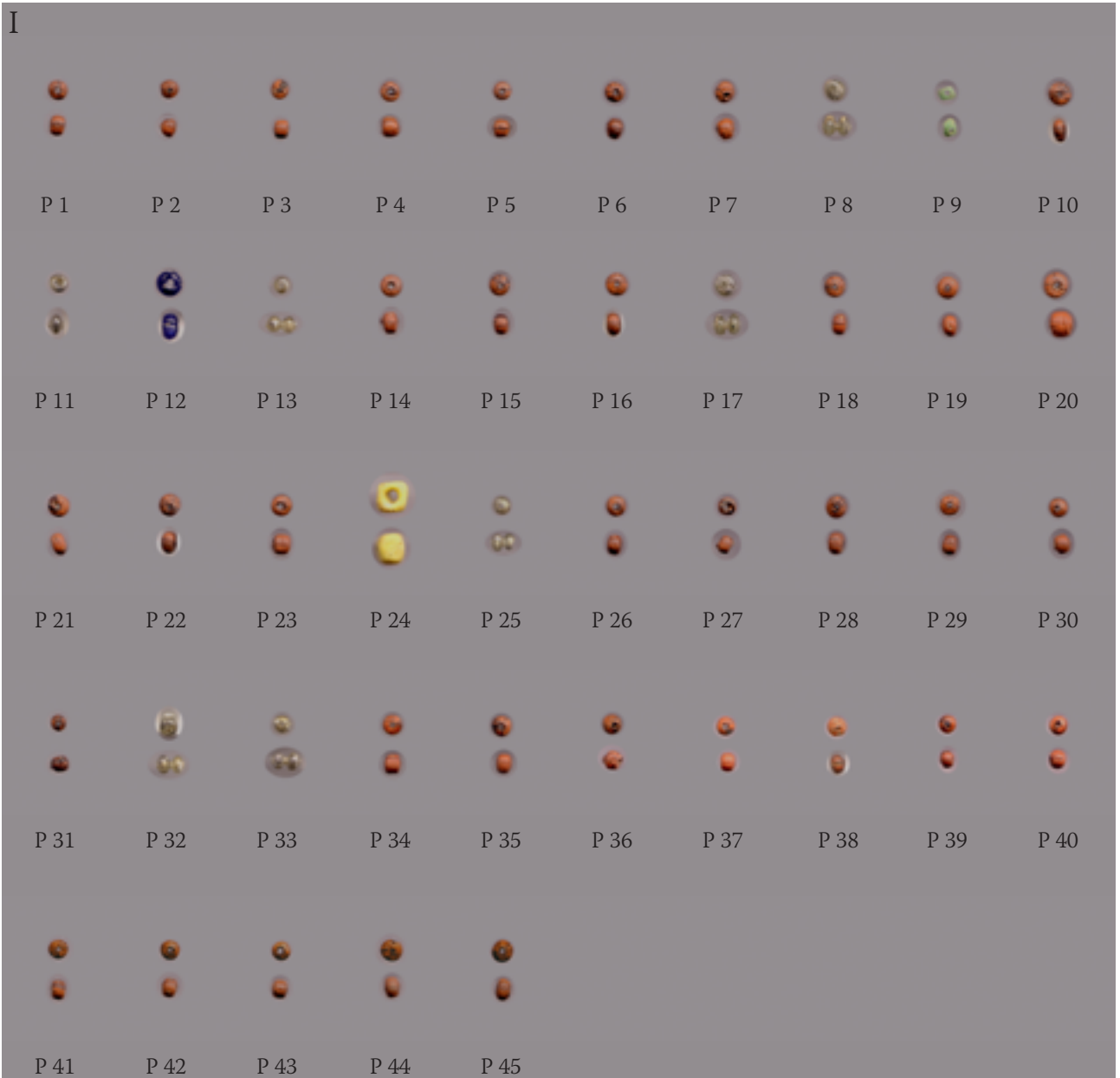
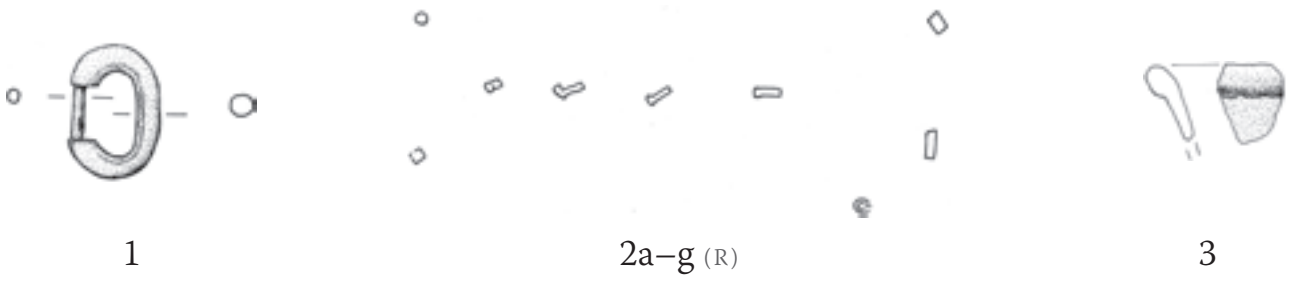

Grab St 176

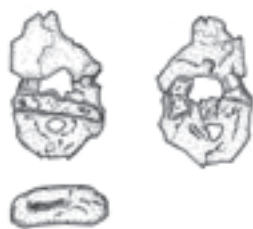

1



2

I-IV



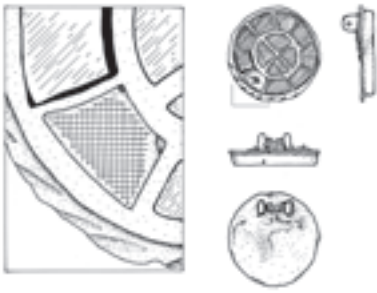

1 (Detail M 5/2)

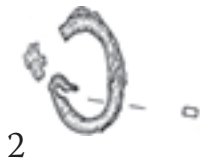

2



5



(B)

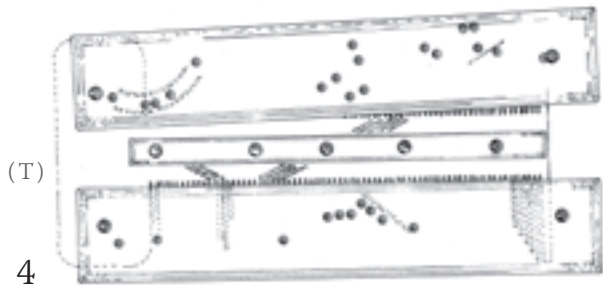

(T)

4

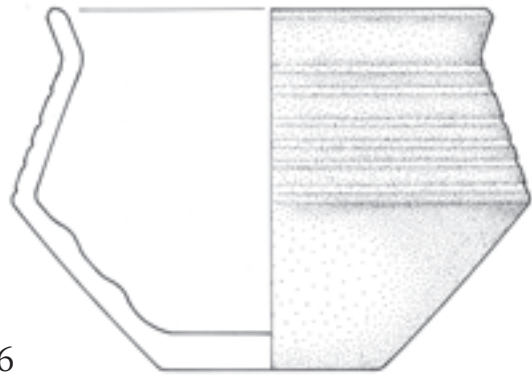

6

I-III



I-III



I-III



Grab St 180

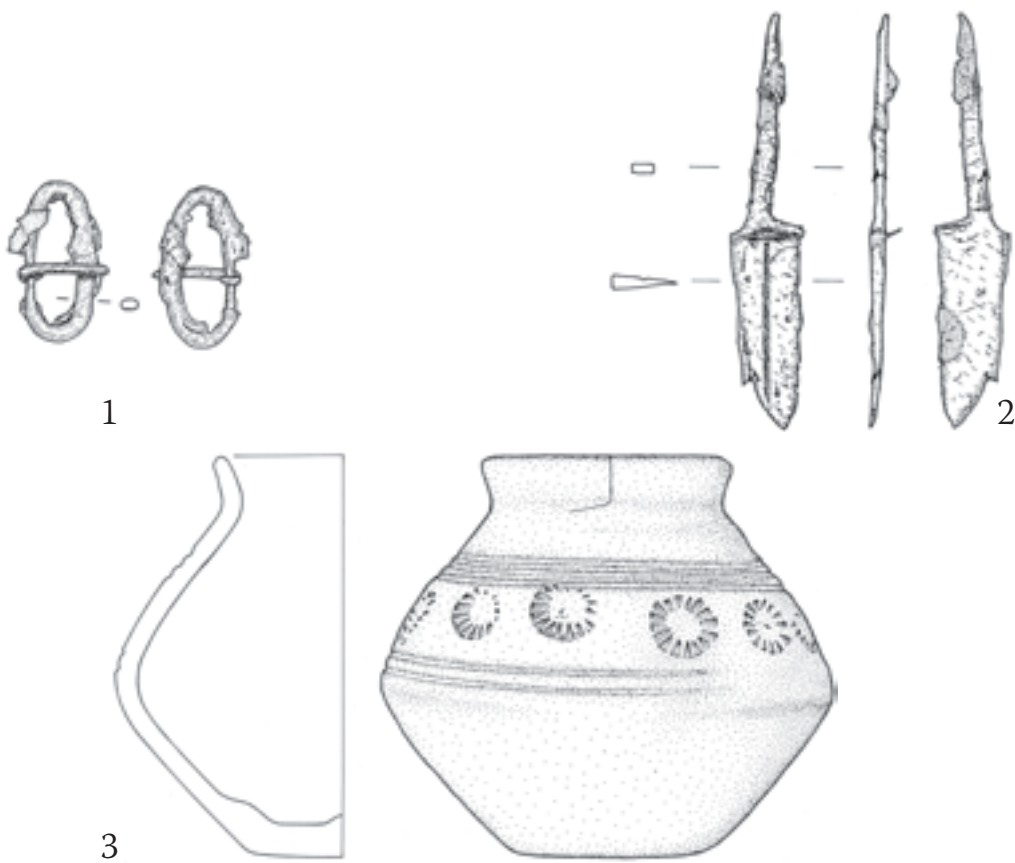

I-IV

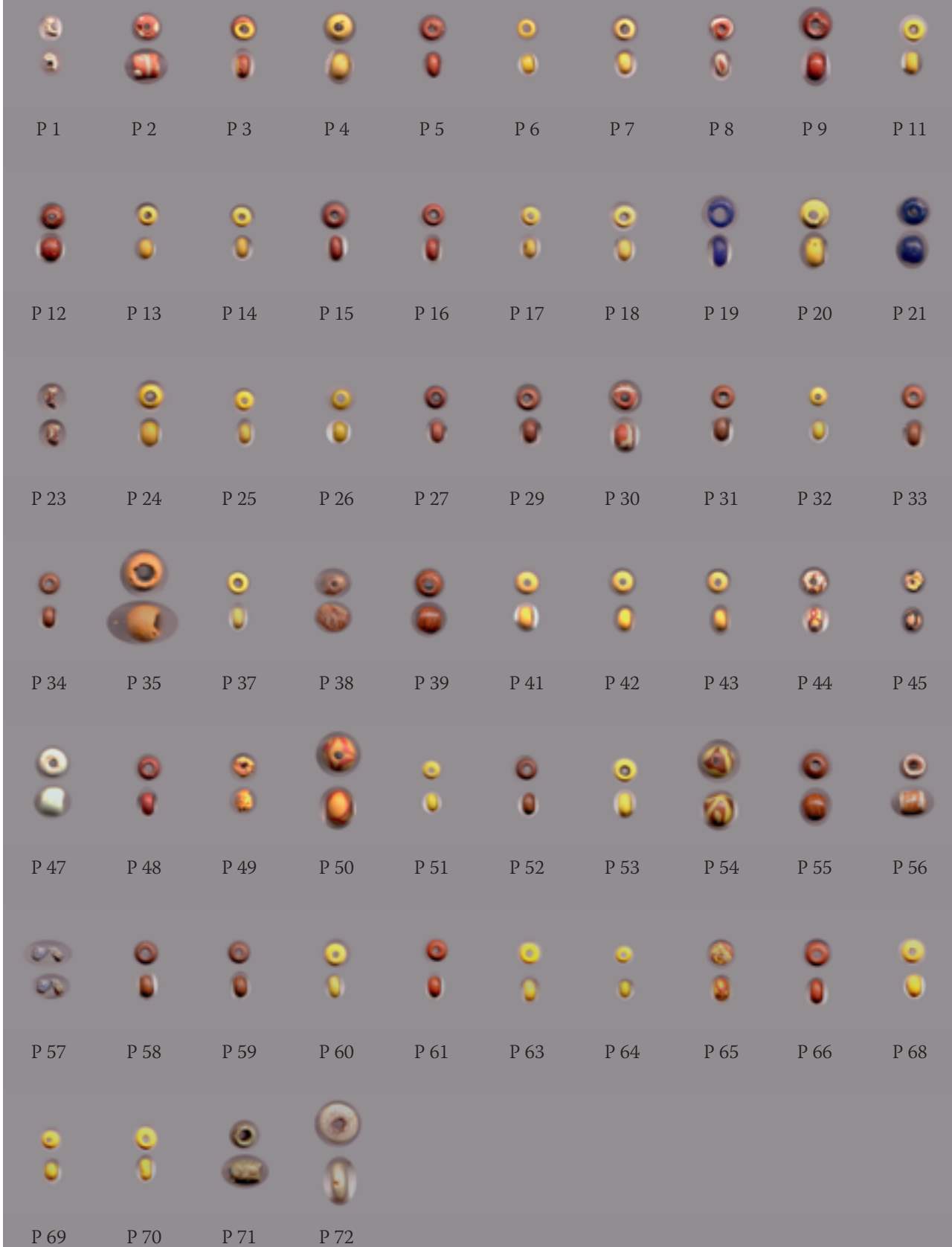

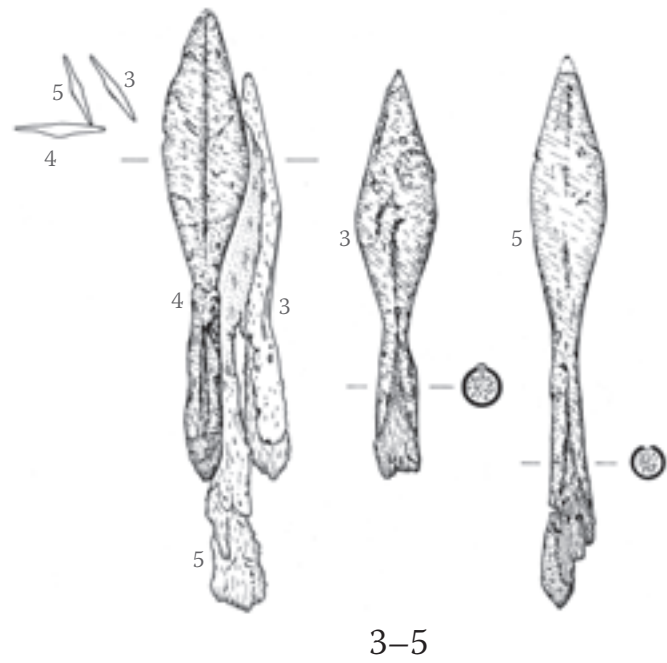
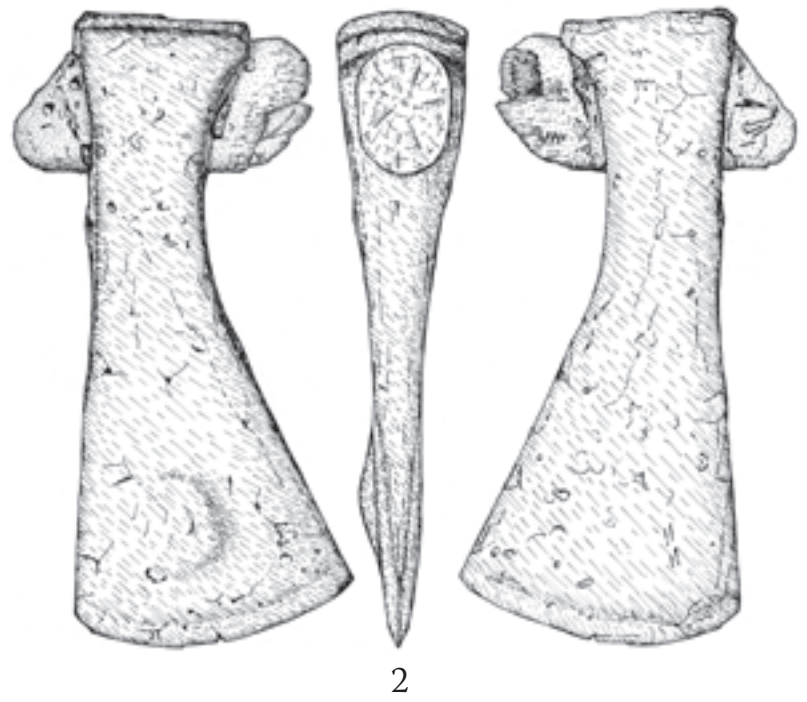
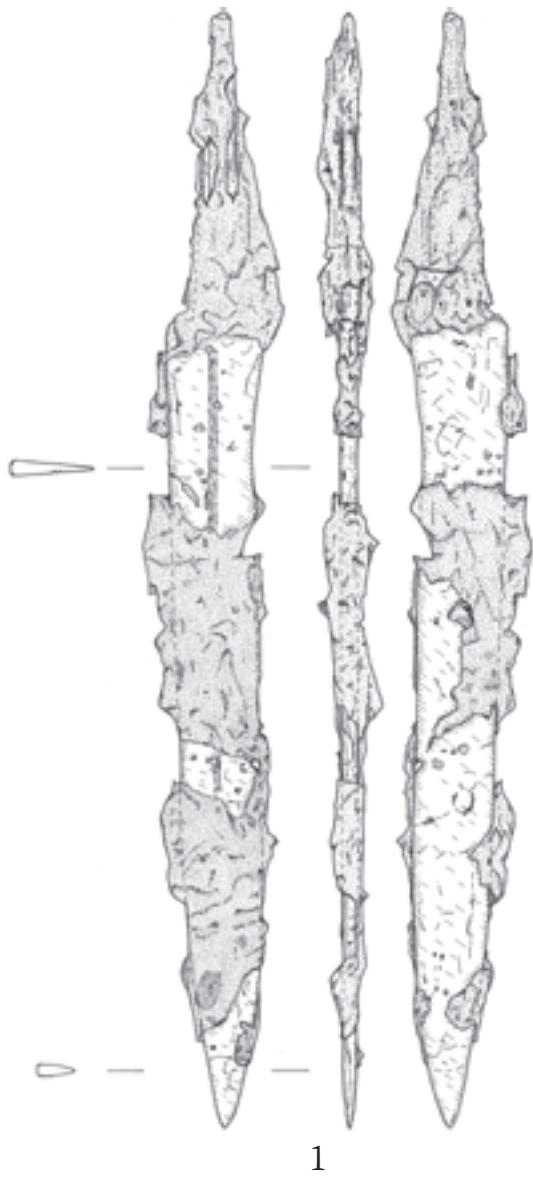

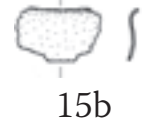
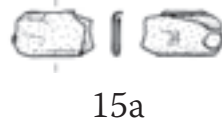
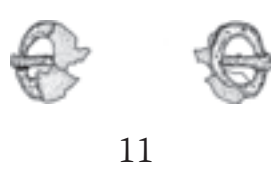
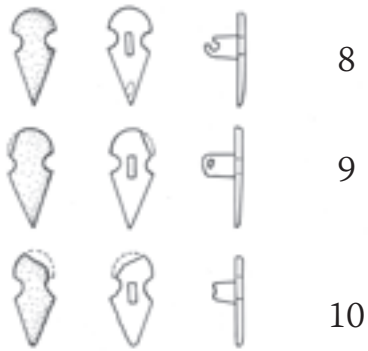
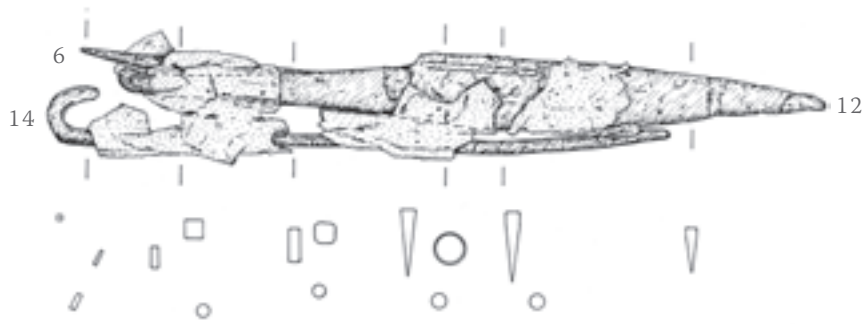

Grab St 185

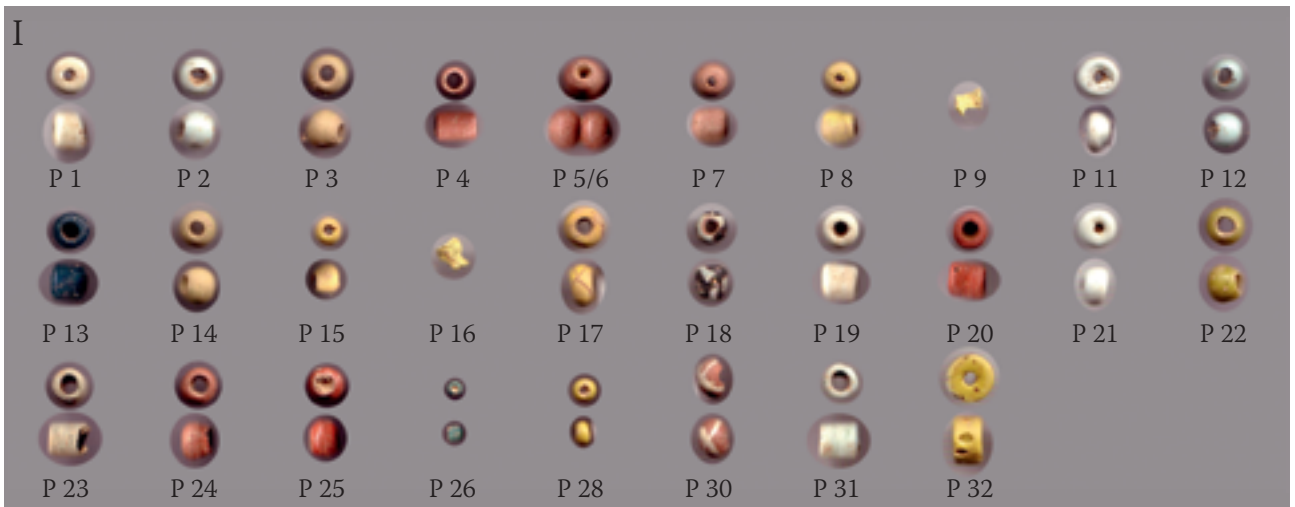
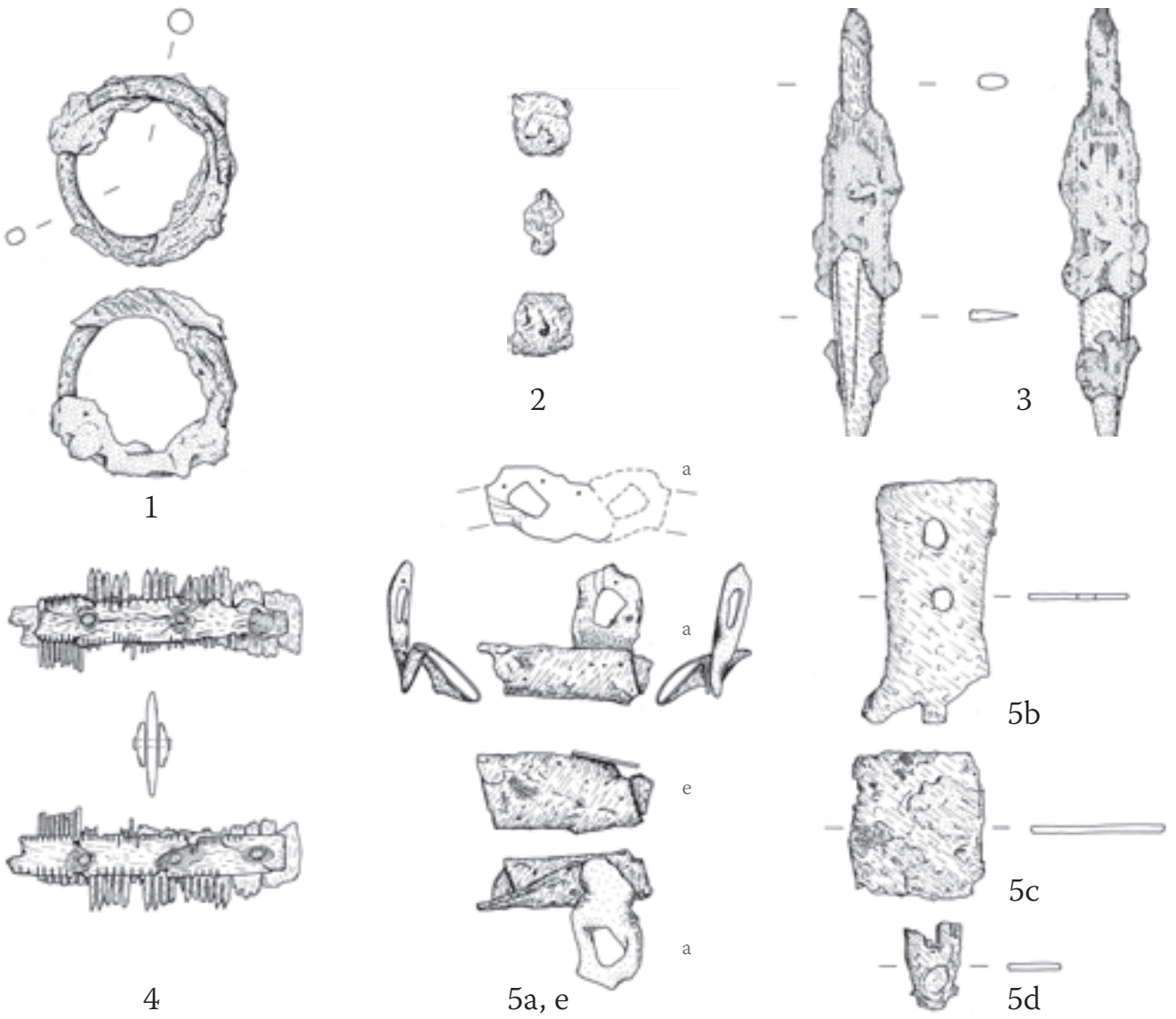

Grab St 186

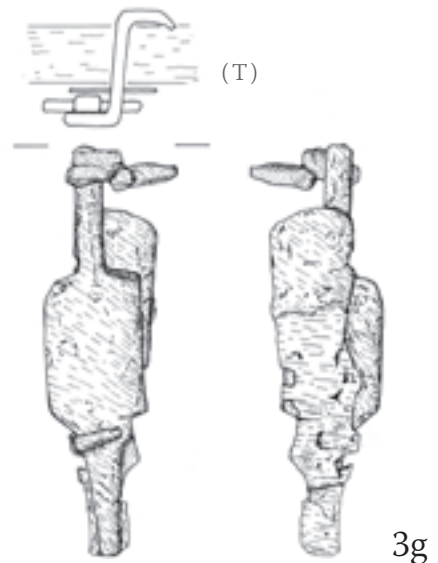
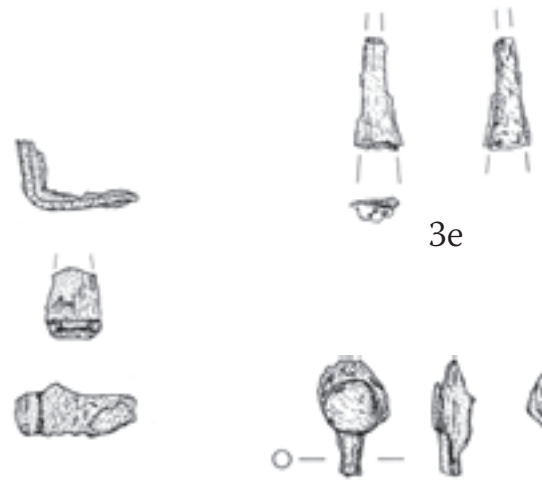

3d

3f

3g

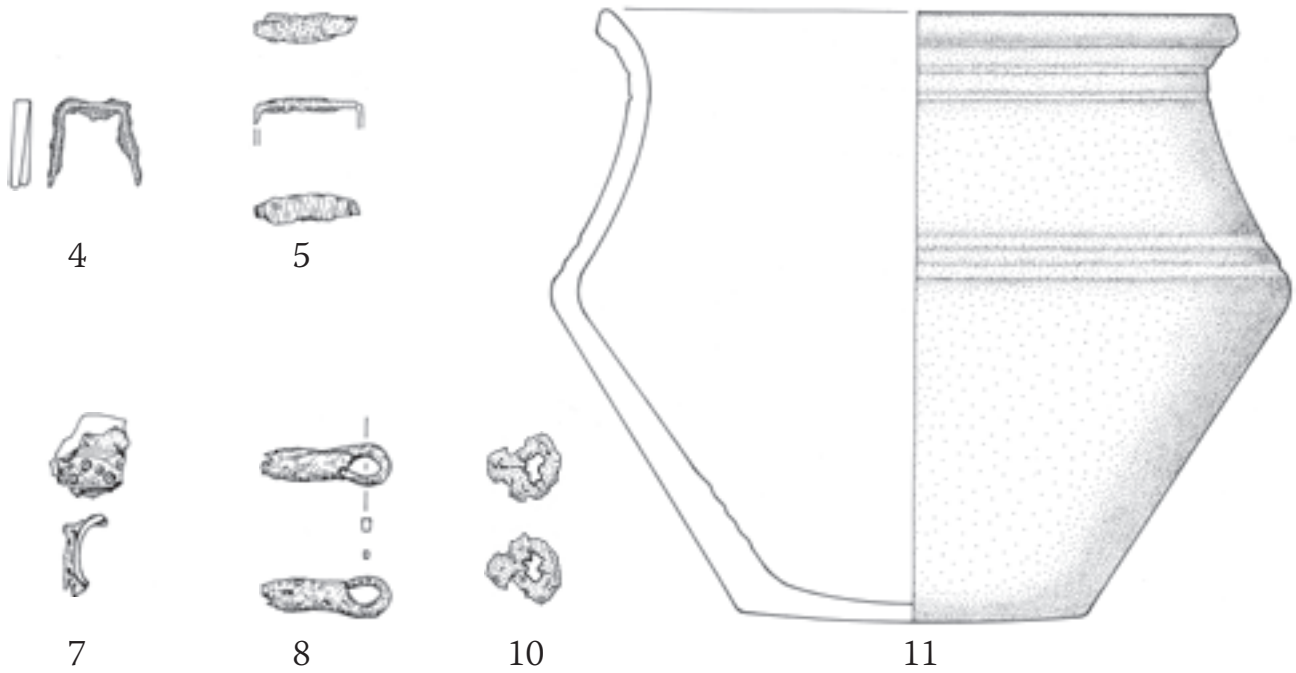

I-III

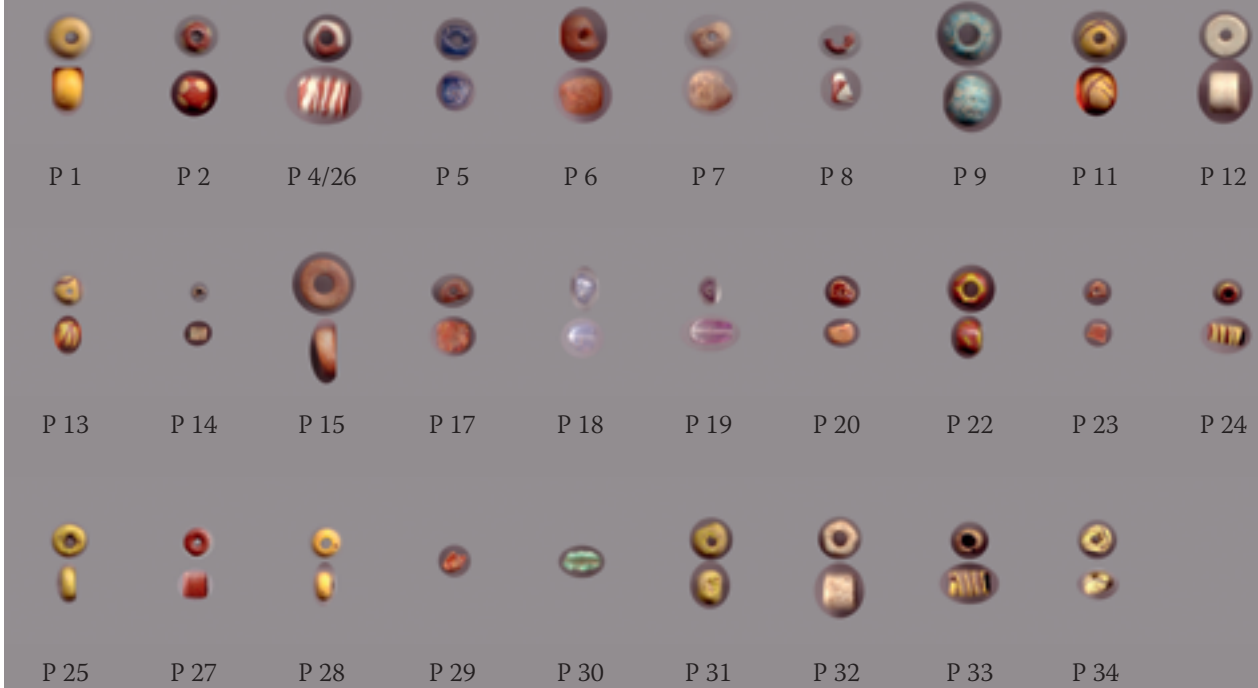

Grab St 187

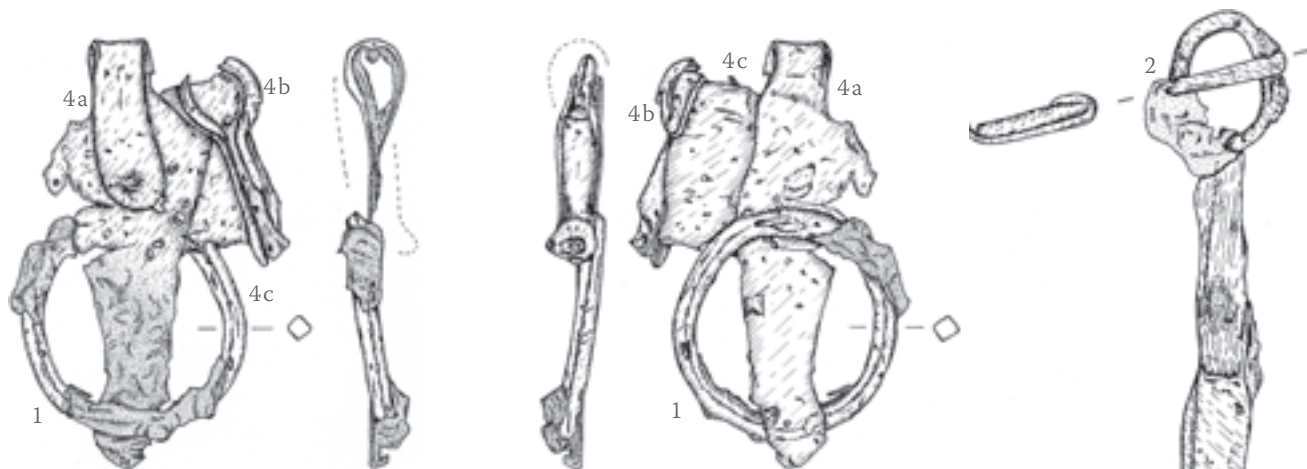

1, 4a-c

1, 4a-c

2, 3 (B)

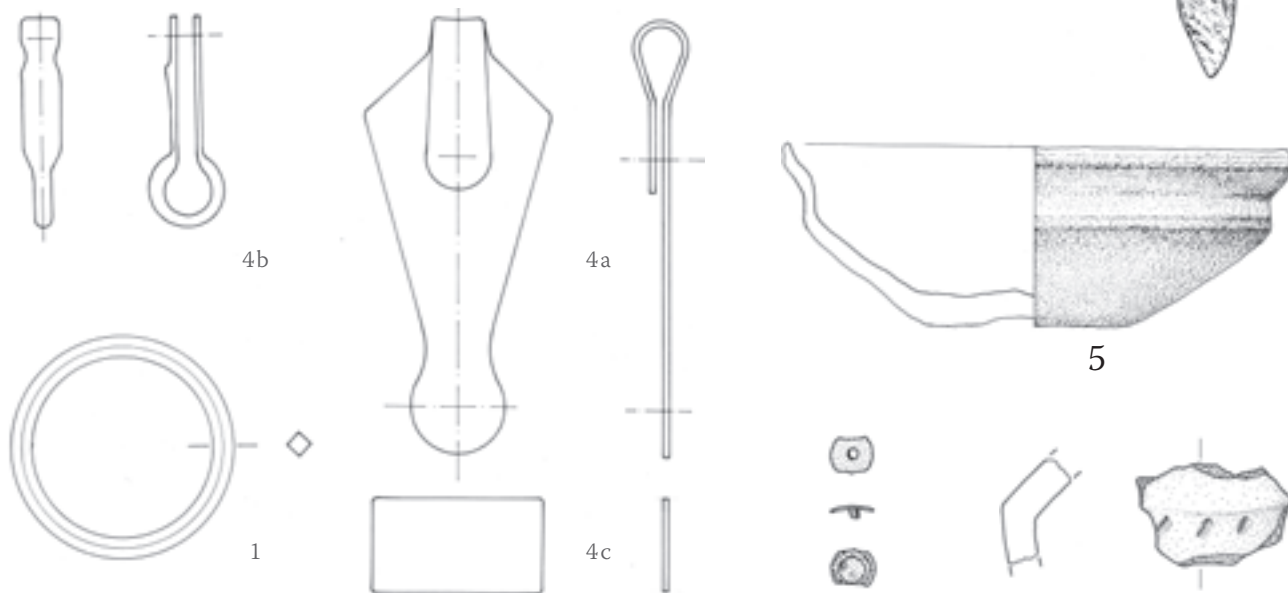

1, 4a-c (T)

6

7





1



2

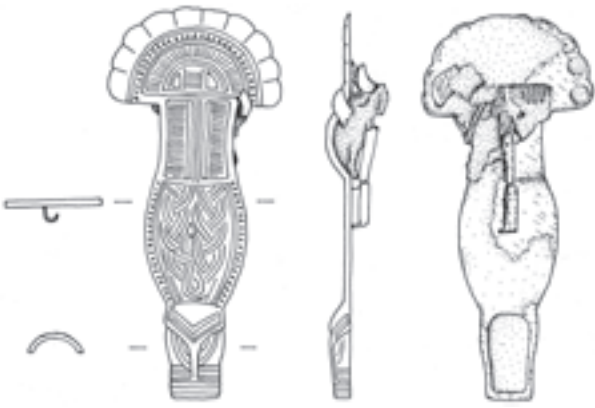

3

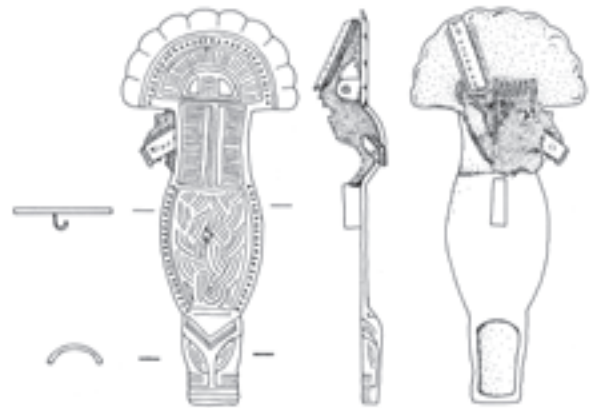

4



5



6

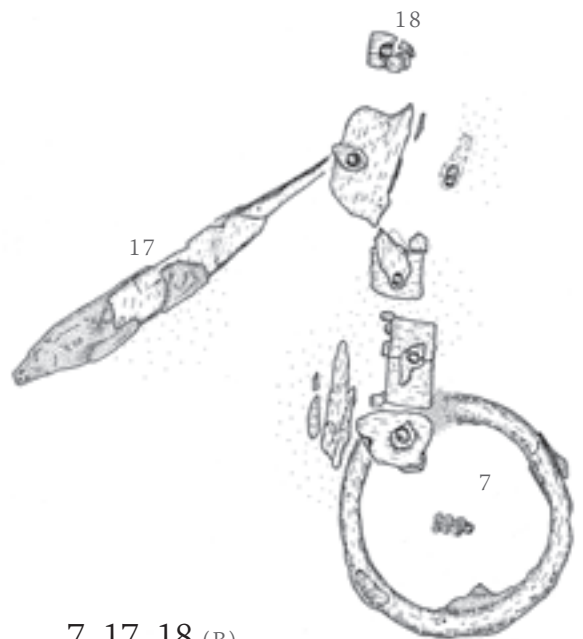

7, 17, 18 (B)



8



9



10



11



12

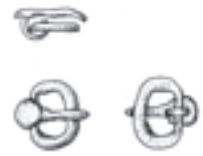

13

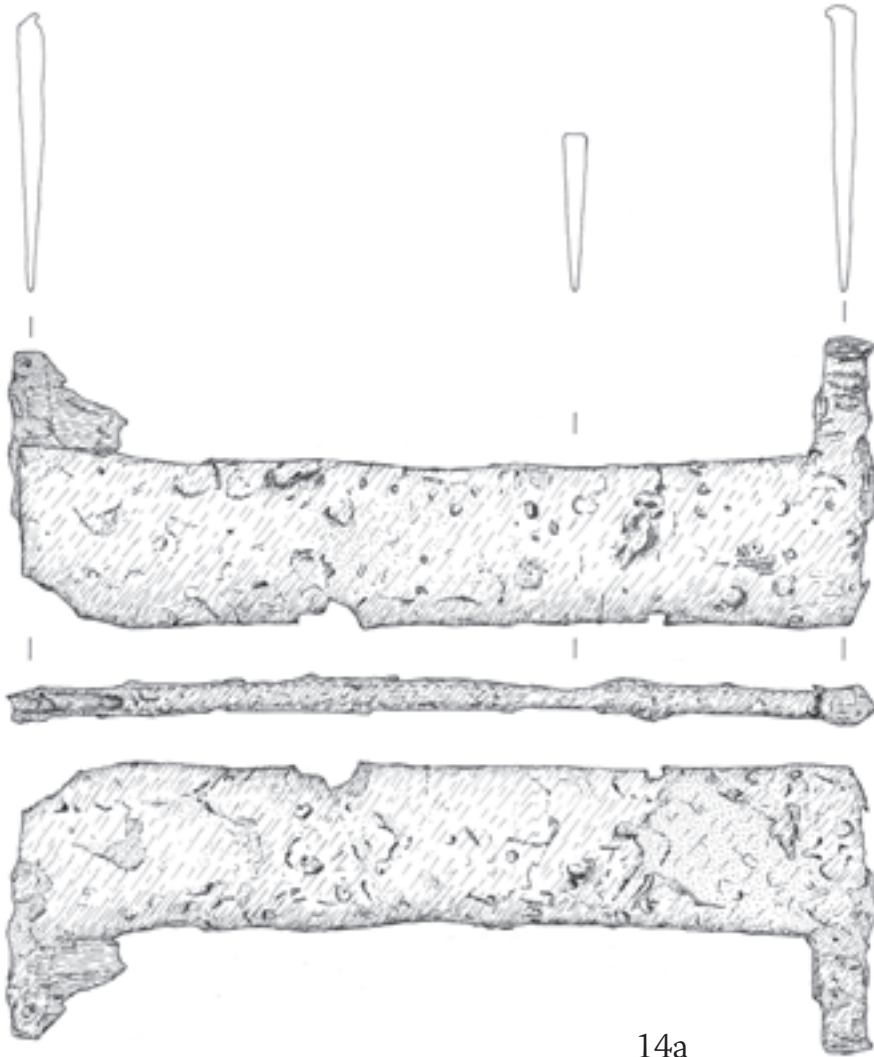

14a



14b



15



16



19



20



21 M 1/1

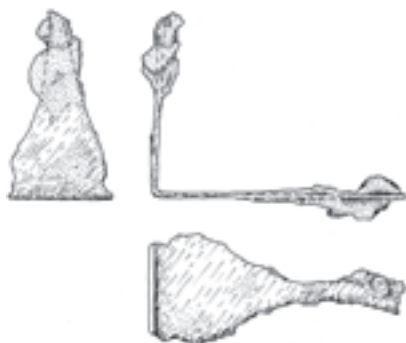

22a



22b



22c



22d



22e



22f



22h

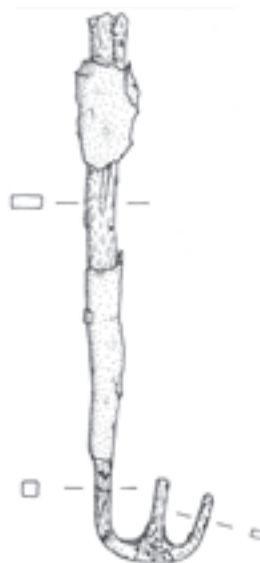

23



22g



24

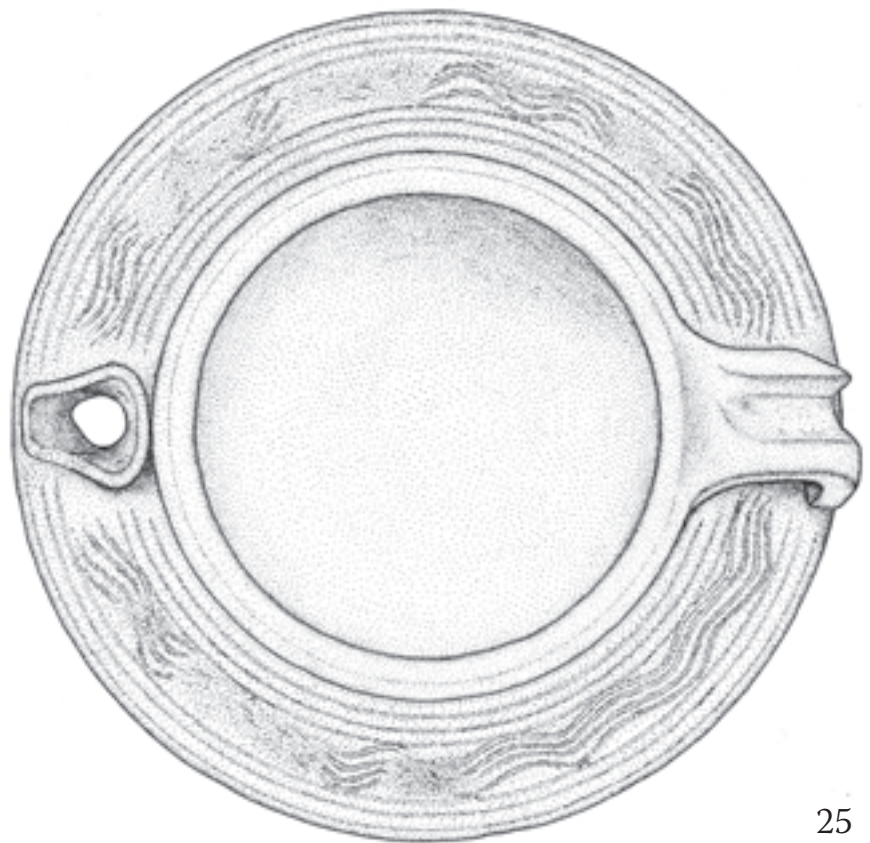

I-VI

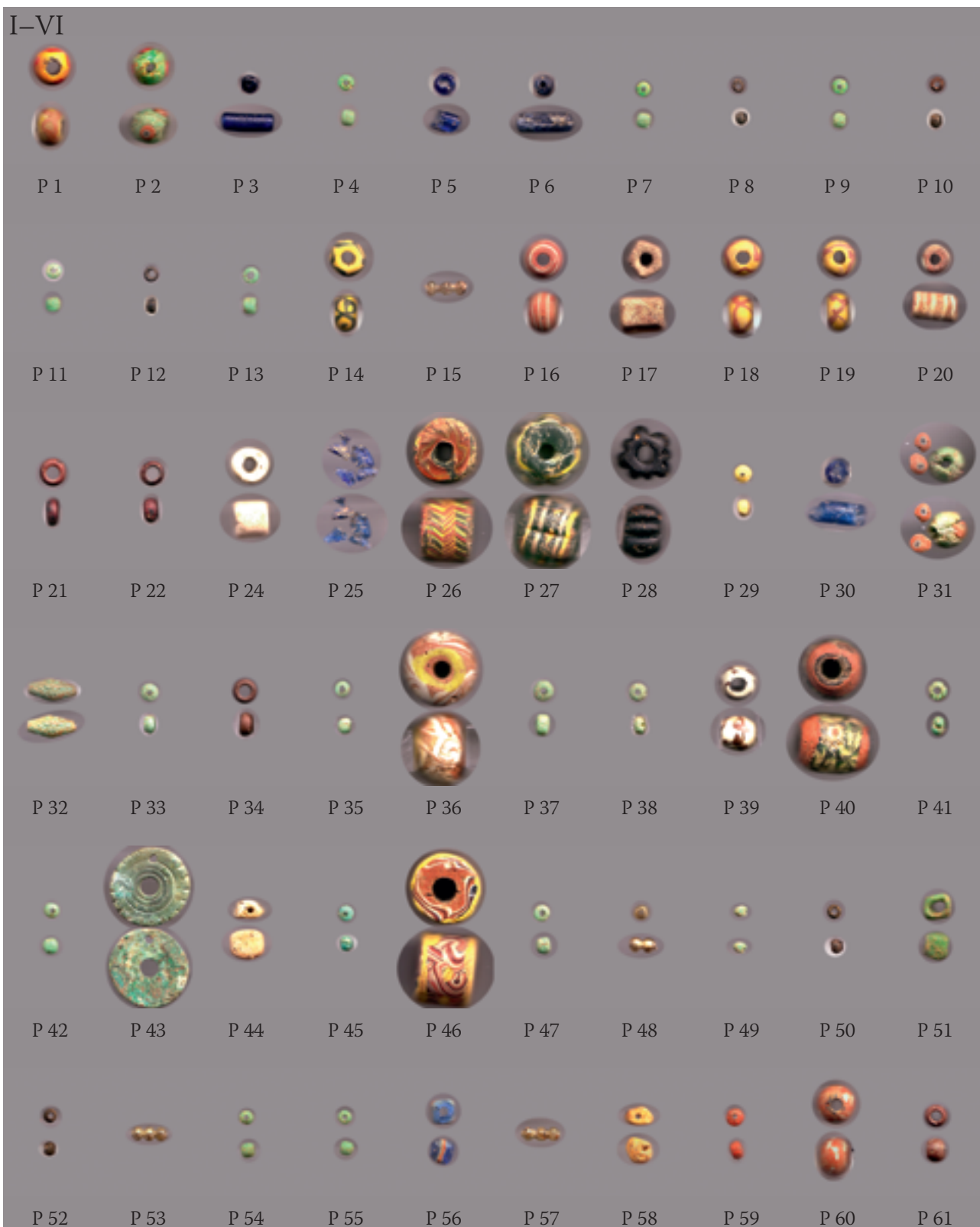

I-VI

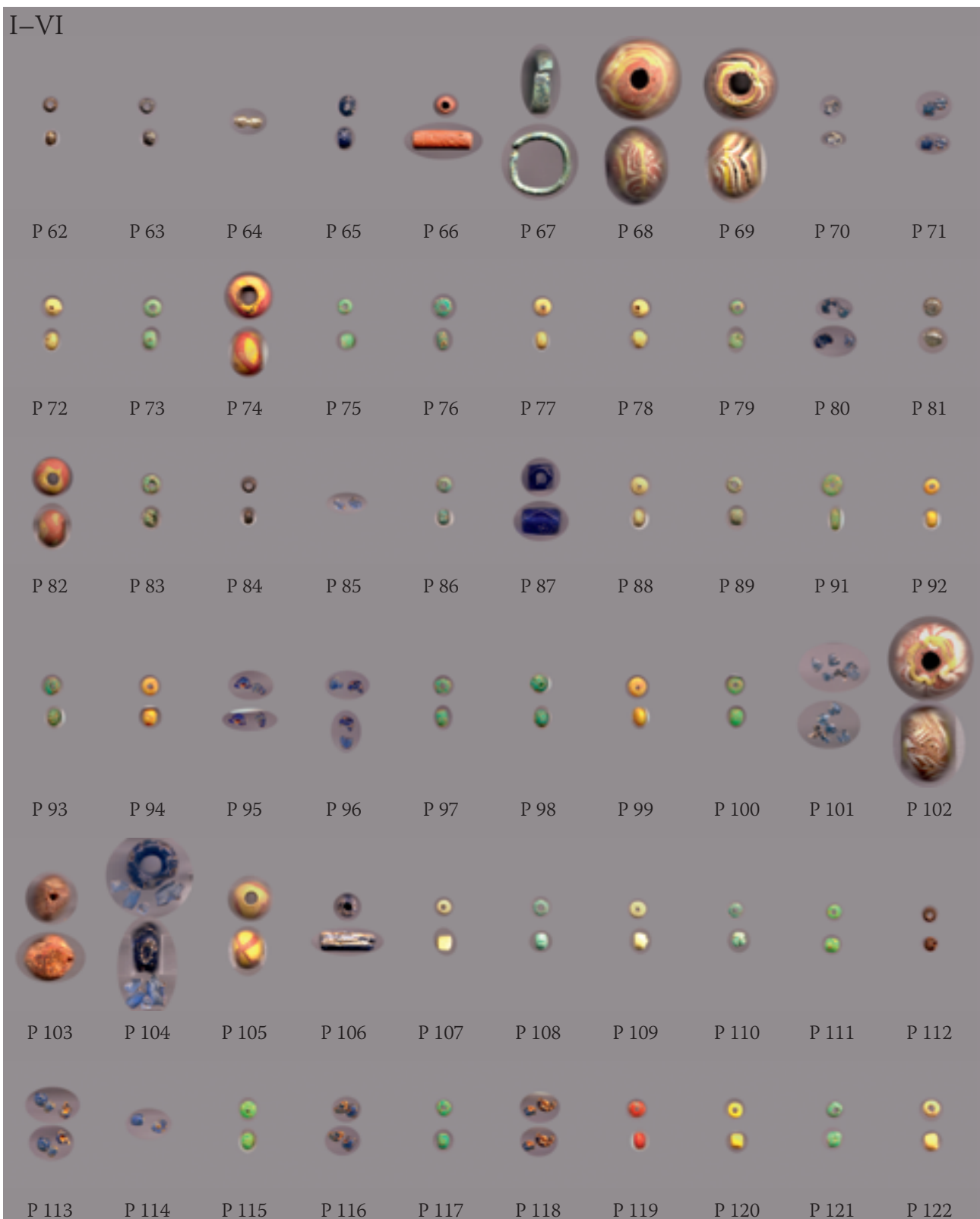

I-VI



I-VI

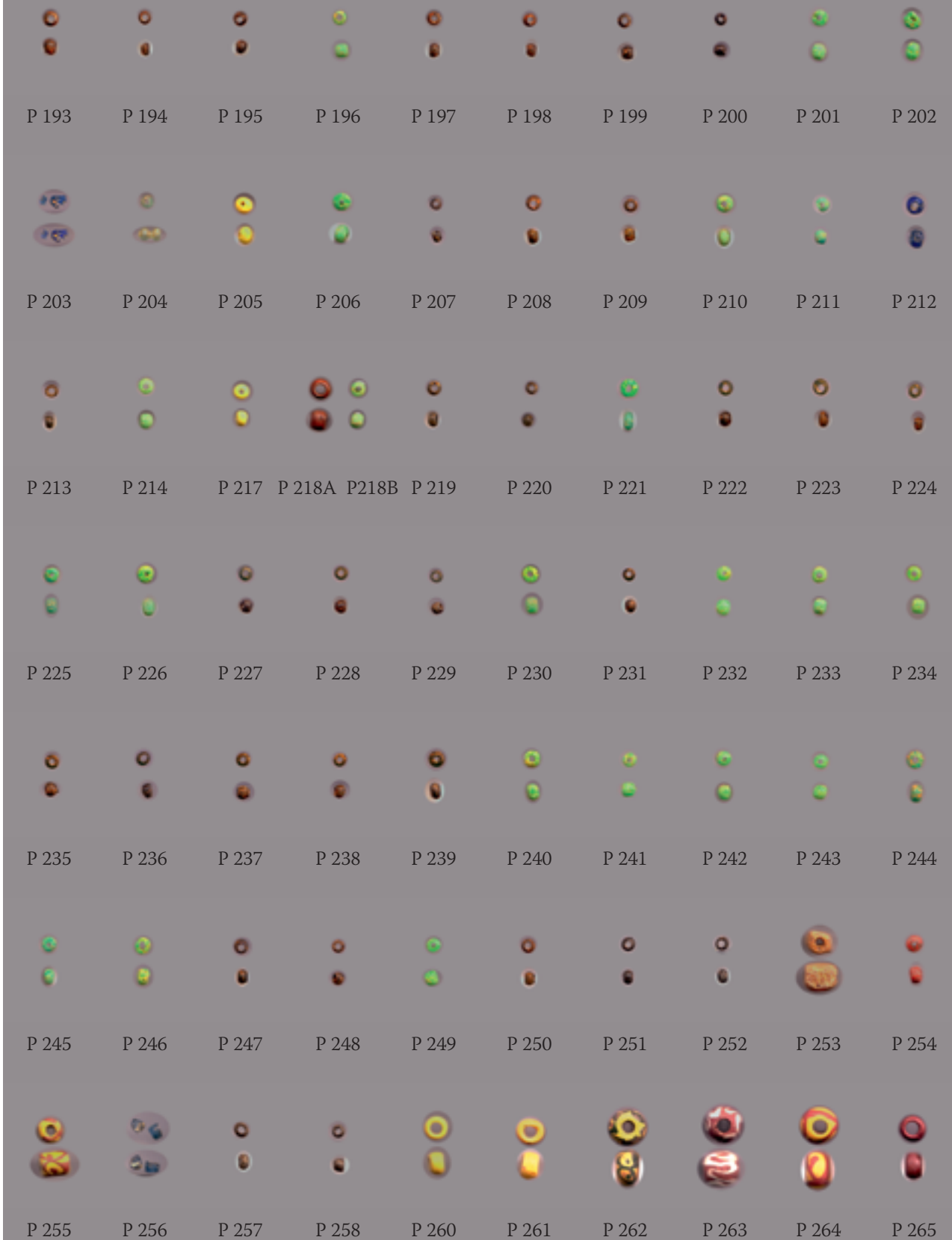

I-VI



P 266



P 267



P 268



P 269



P 270



P 271



P 272



P 273



P 274



P 275



P 276



P 277



P 278



P 279



P 280



P 281



P 282



P 283



P 284



P 285



P 286



P 287



P 288



P 289



P 290



P 291



P 292



P 293



P 294



P 295



P 296



P 297



2



4a



4b



4c



4d



4e-g



4g

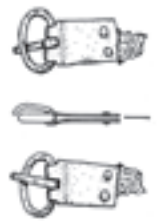

4h

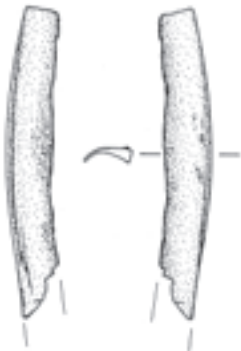

4i

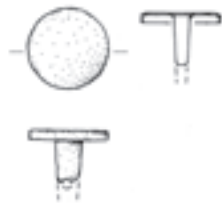

4j

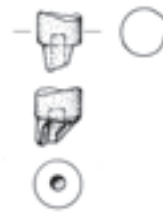

4k



4m



4n



4o, y



4p

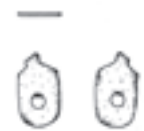

4r



4s



4t

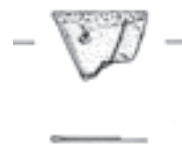

4v



4w

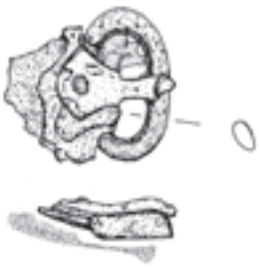

1a

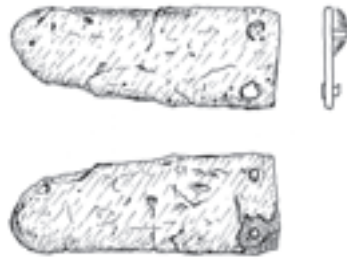

1b

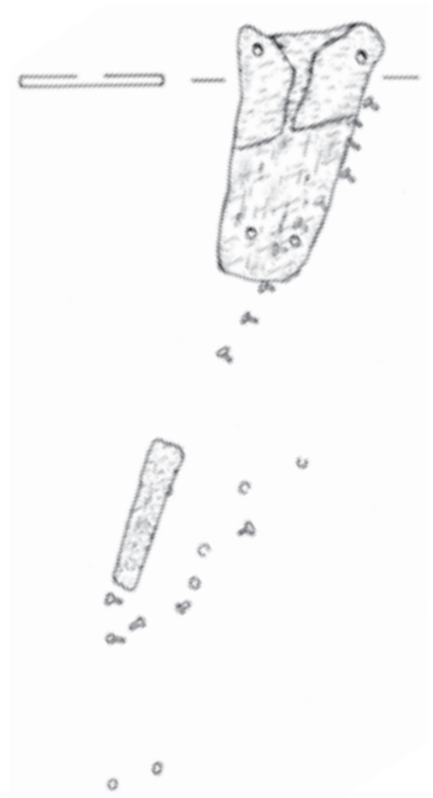

2 (B/R)



1d



1c



1e



1f



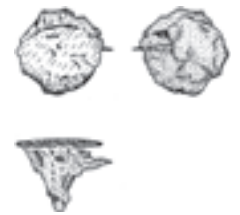
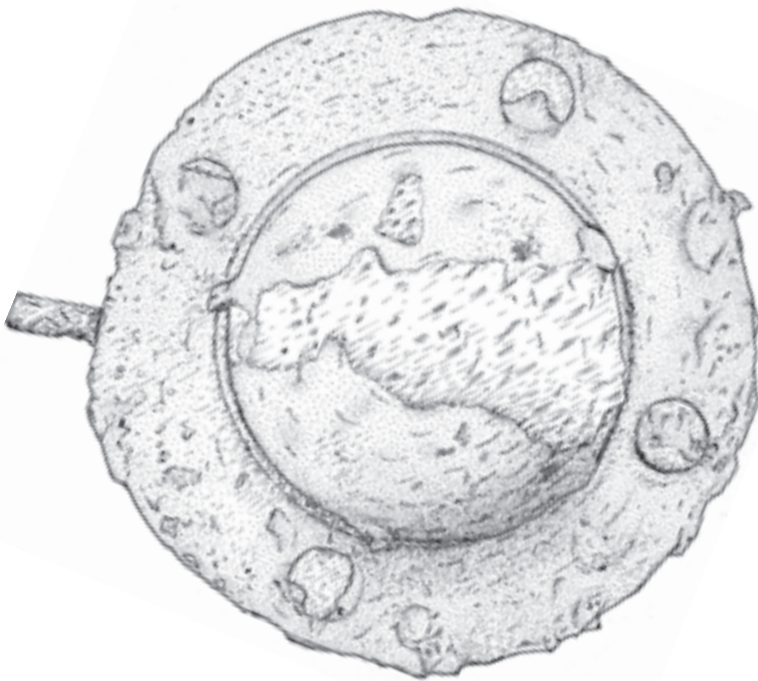

3b



3c

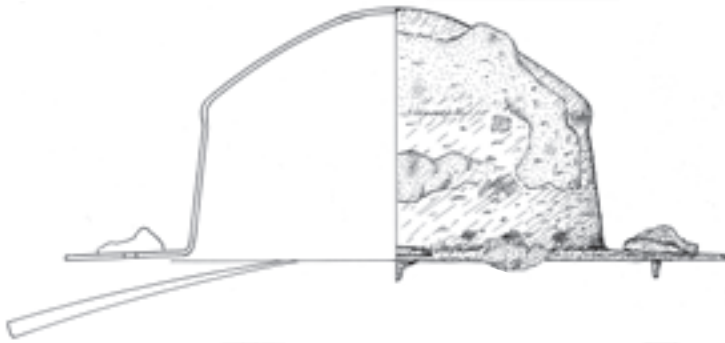

3d

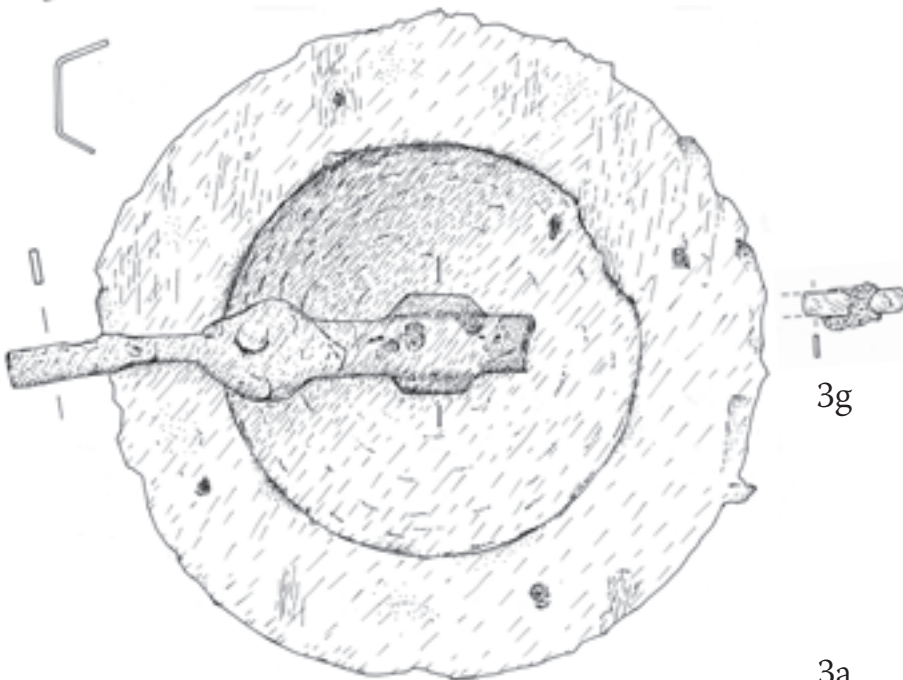

3g

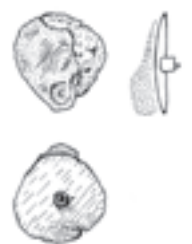

3e



3f

3a

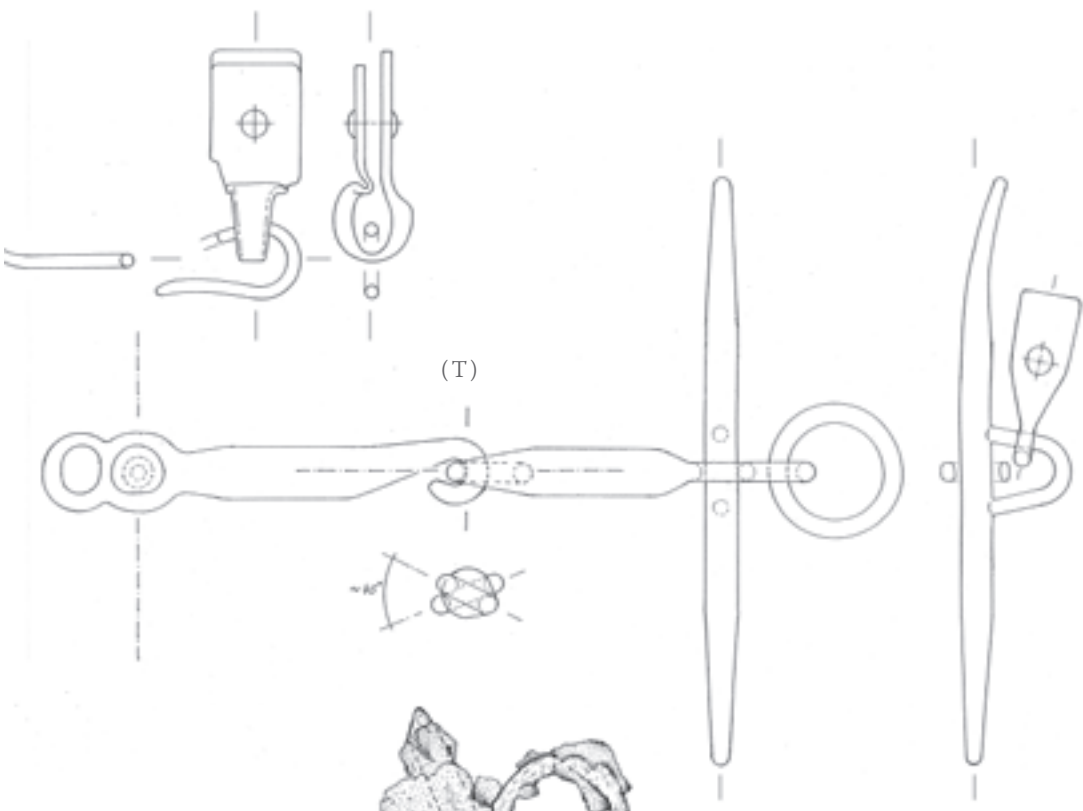
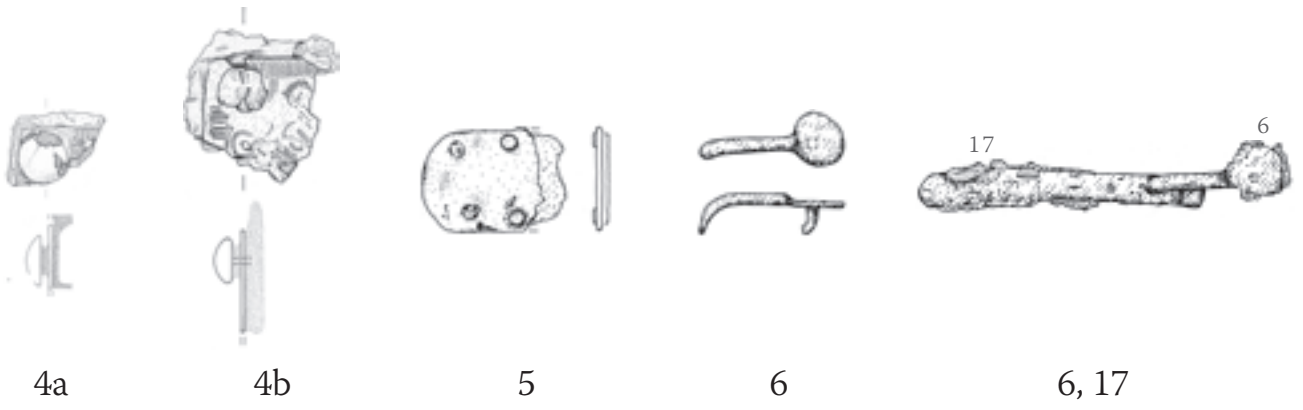

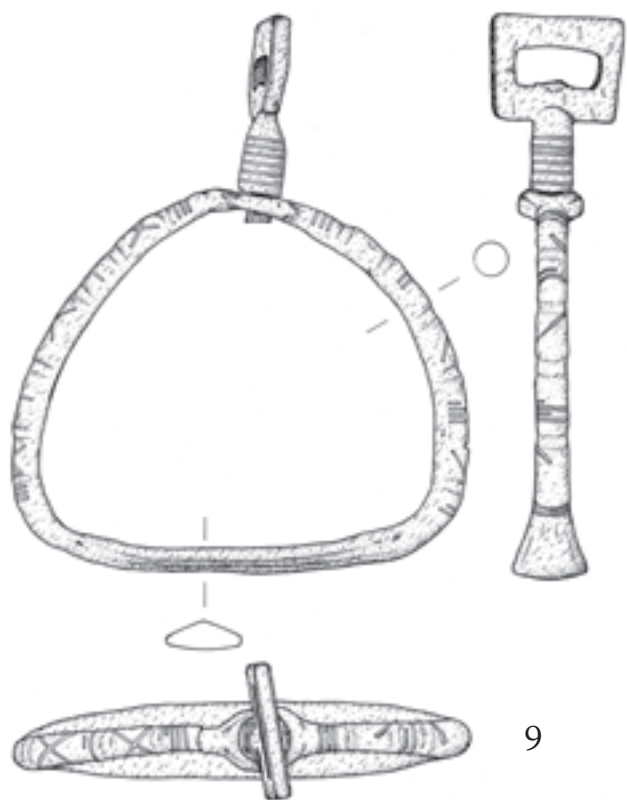

9



10

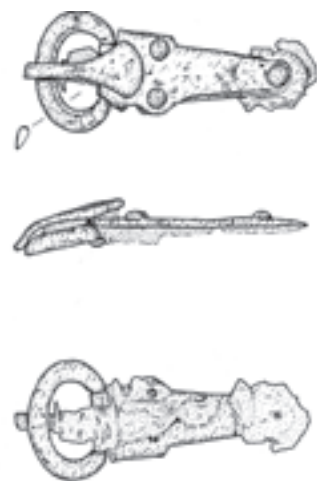

11



12



13

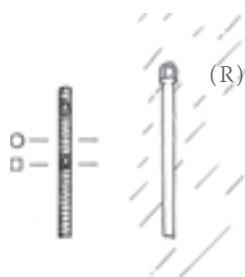

14



15

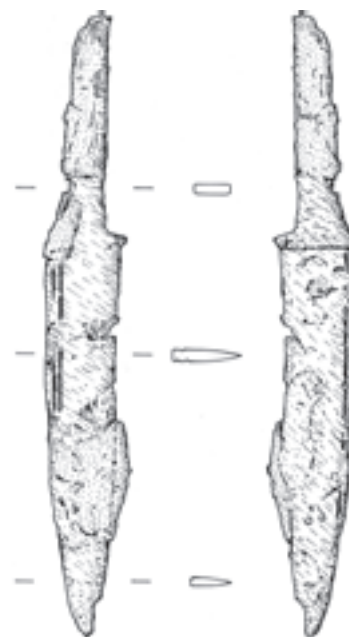

16



17



18b-e (R)



19

keine
Nutzungs-
rechte für
Open-Access-
Veröffent-
lichung

20 M 1/1

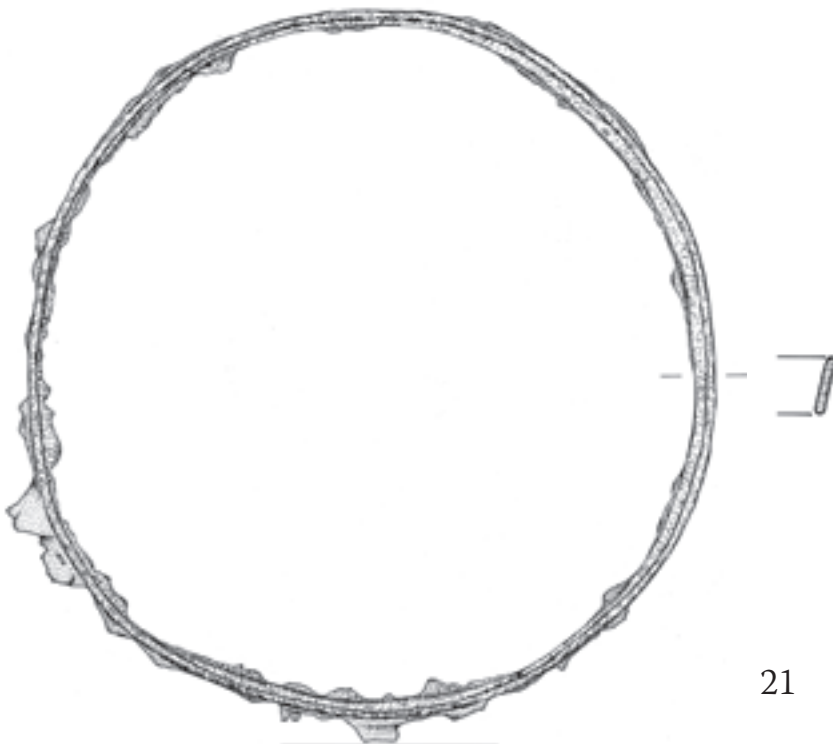

21



22a



22b

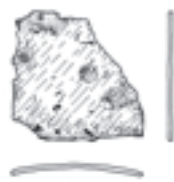

22c



22d



22e



23



25



26



28



29



30a

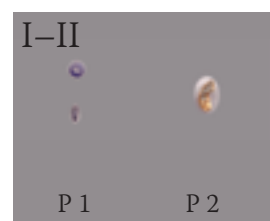

Streufund

