

TAFELN

BFJ

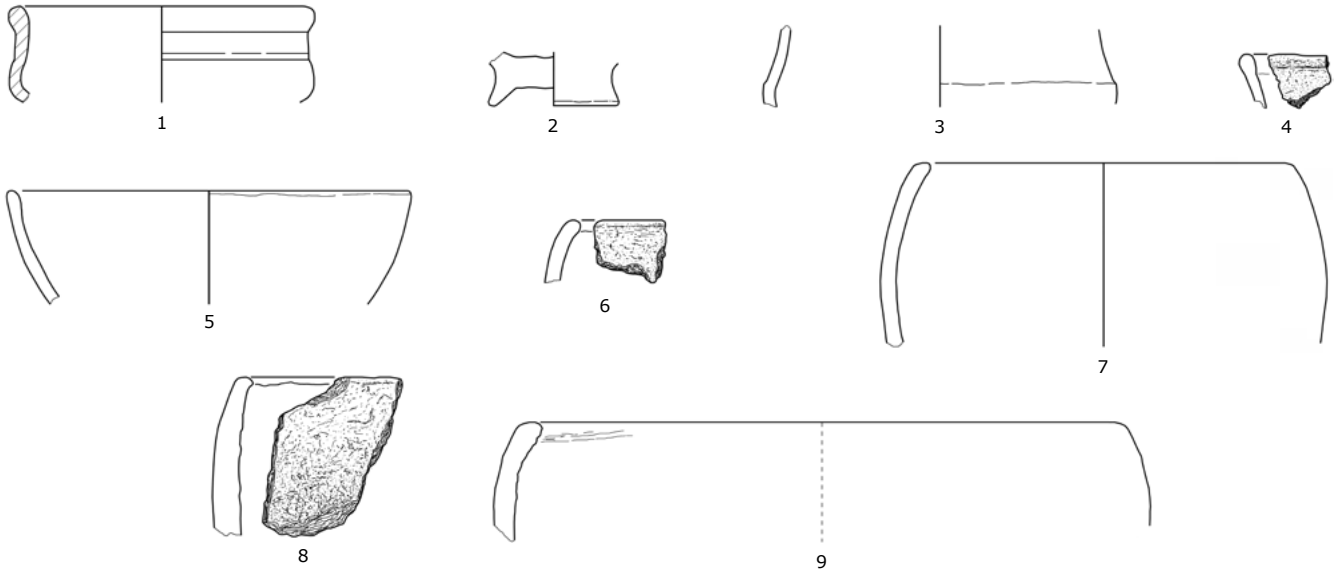

BAB BK 1



BAB BK 2

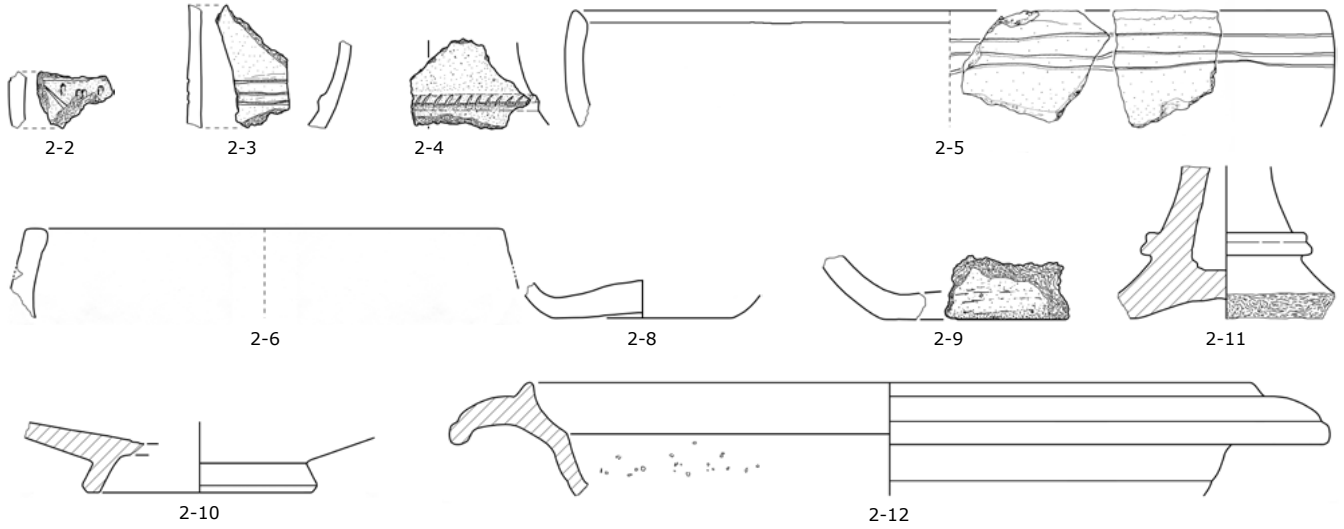

BAB BK 4

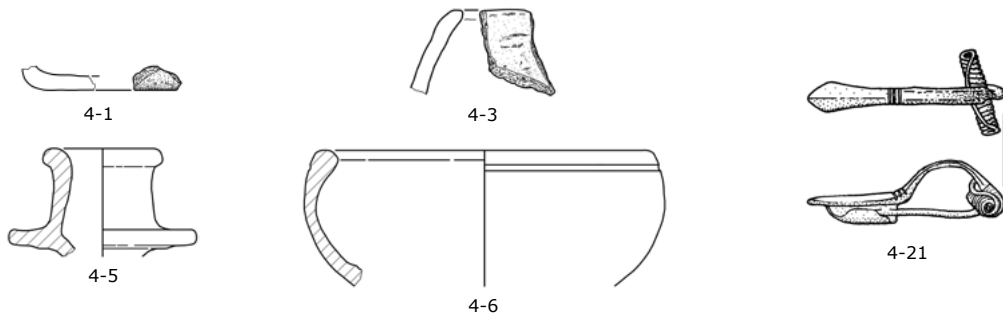

BAB BK 5

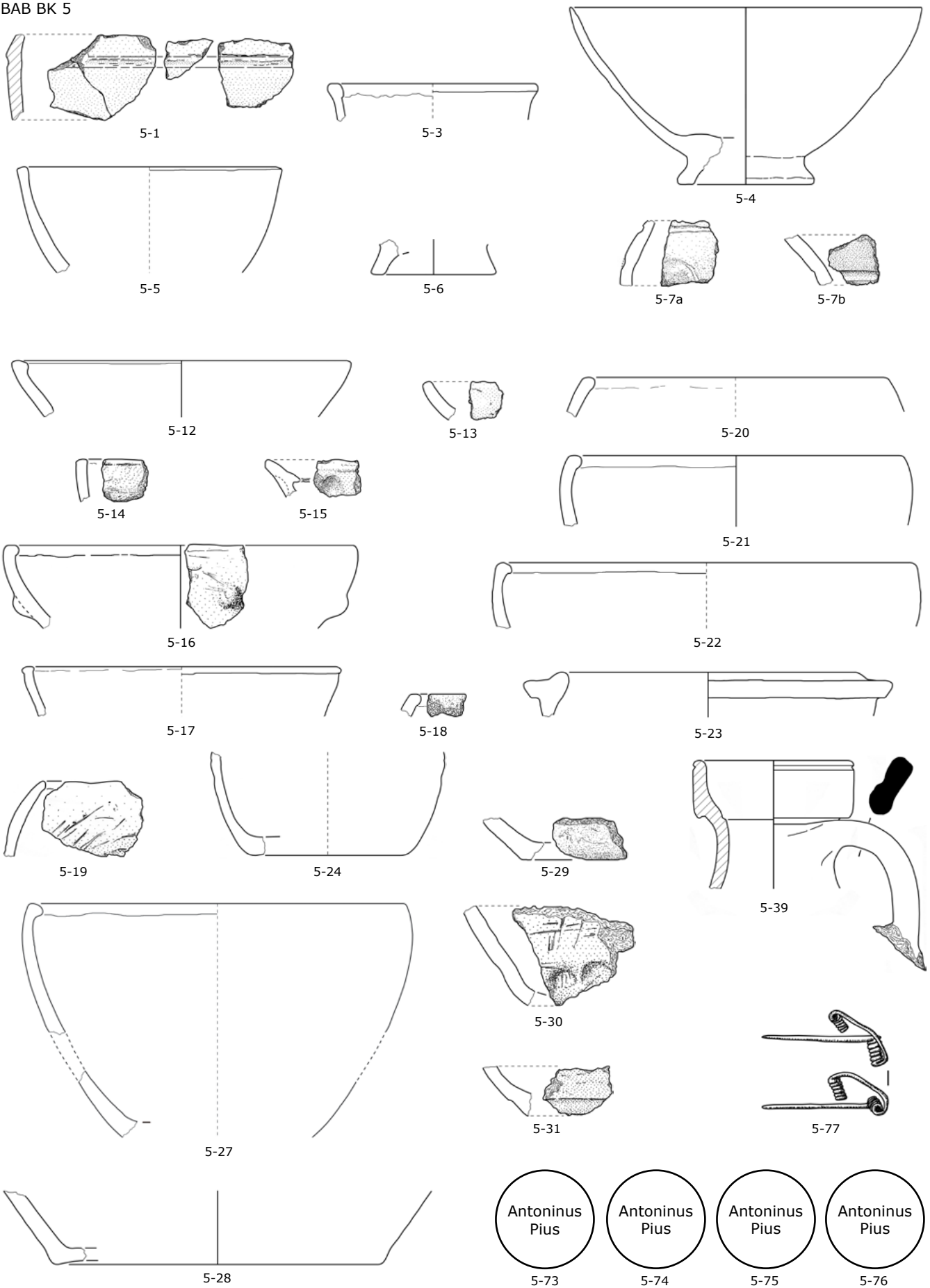

BAB BK 6

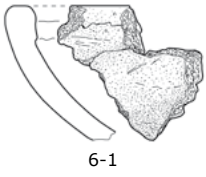

BAB BK 7

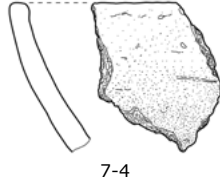
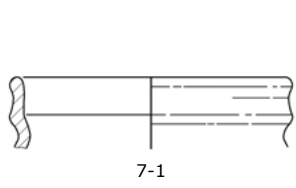

BAB BK 8

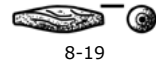
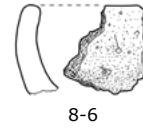
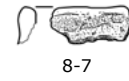
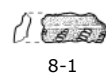

BAB BK 9

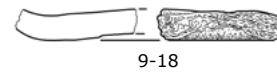
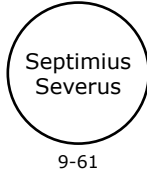
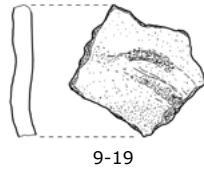
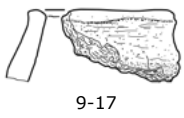
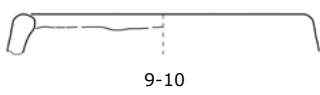
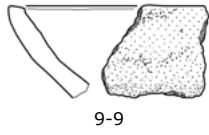
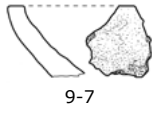
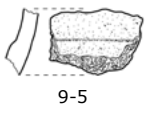
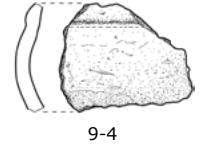
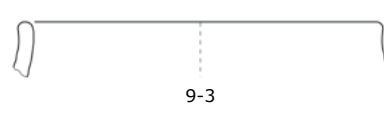
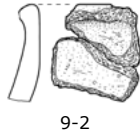
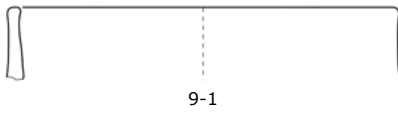

BAB BK 11



BAB BK 13

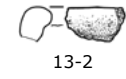
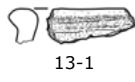

BAB BK 17

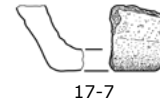
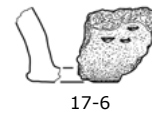
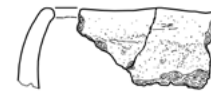
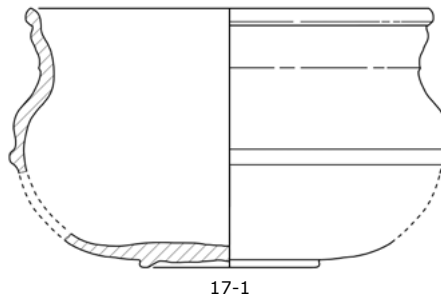

BAB BK 18

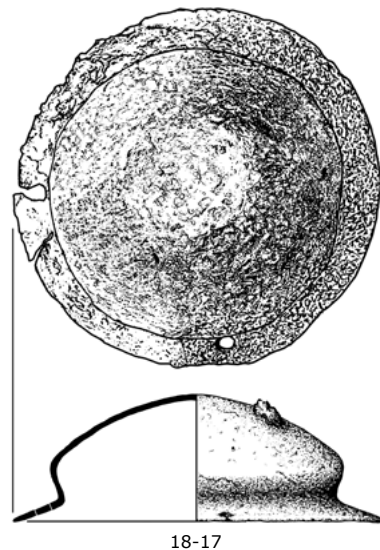
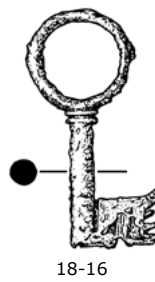
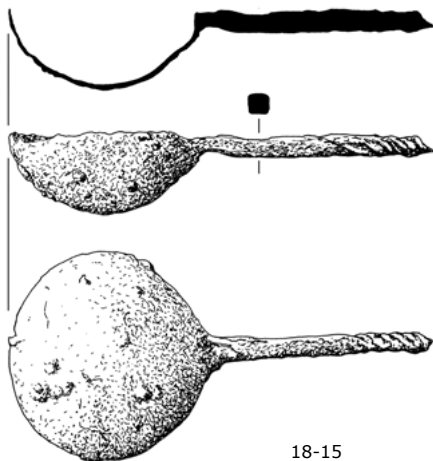

BAB BK 22

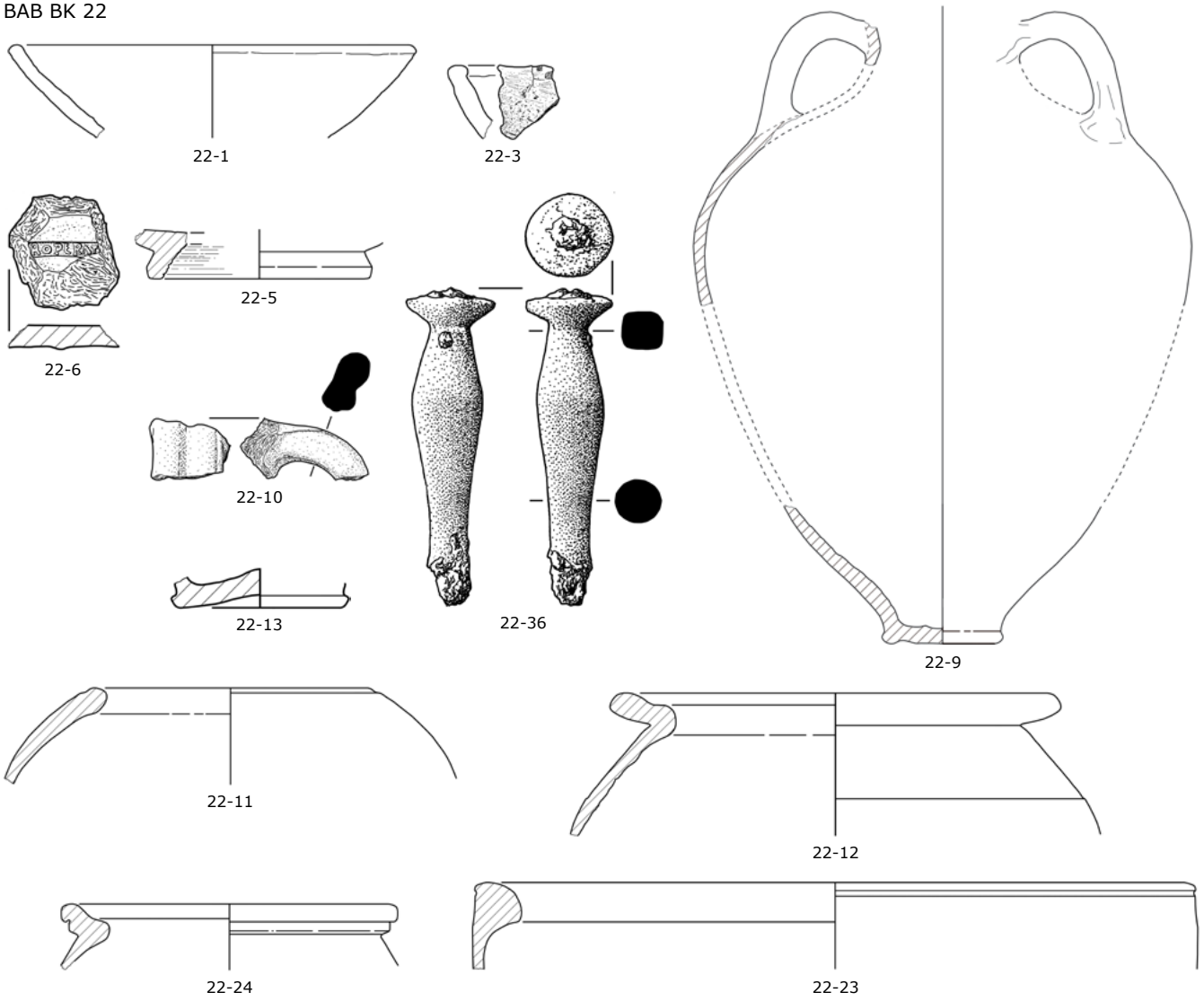

BAB BK 25

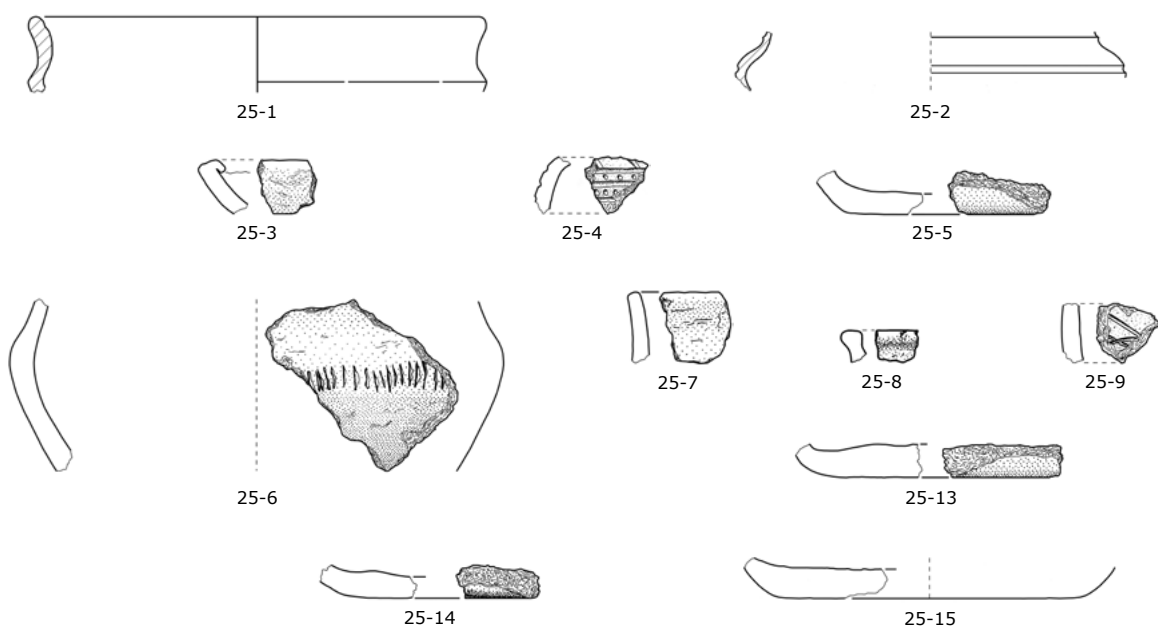

BAZ

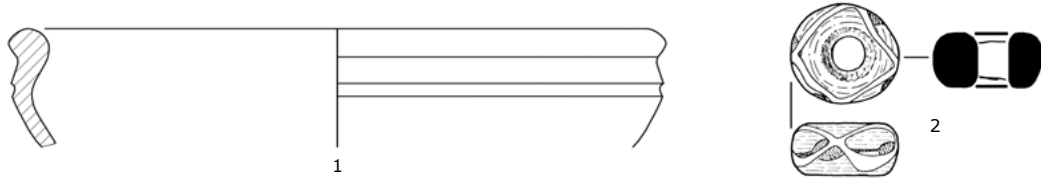

BAW

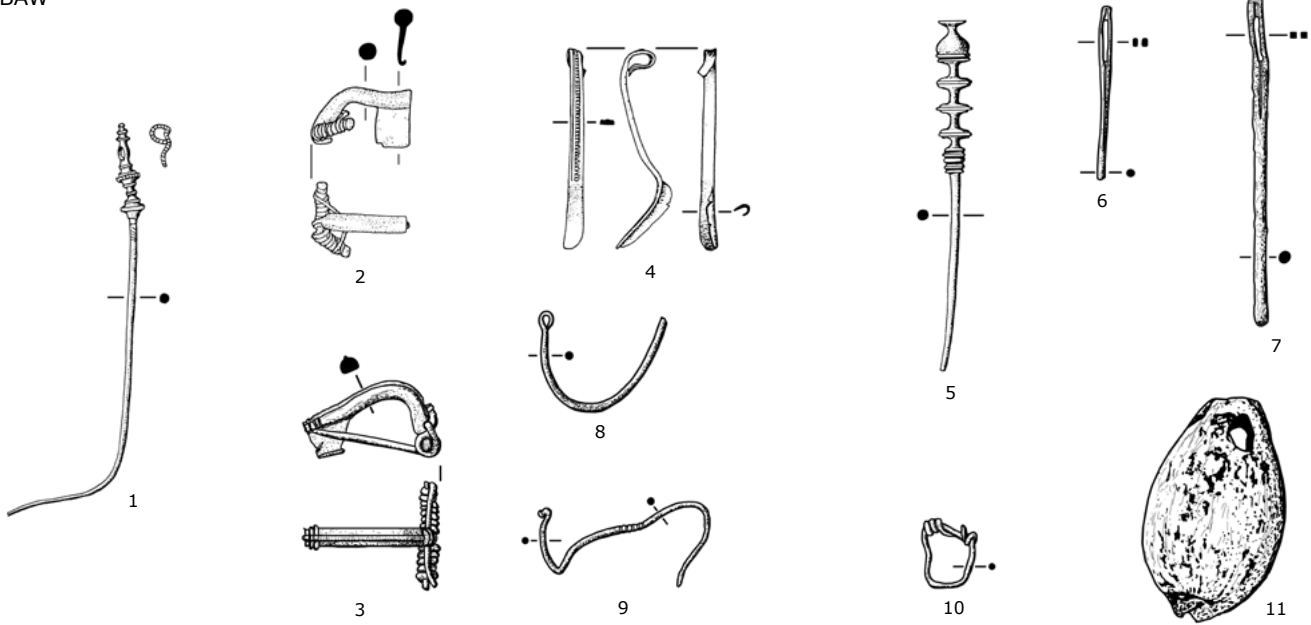

BRM-A

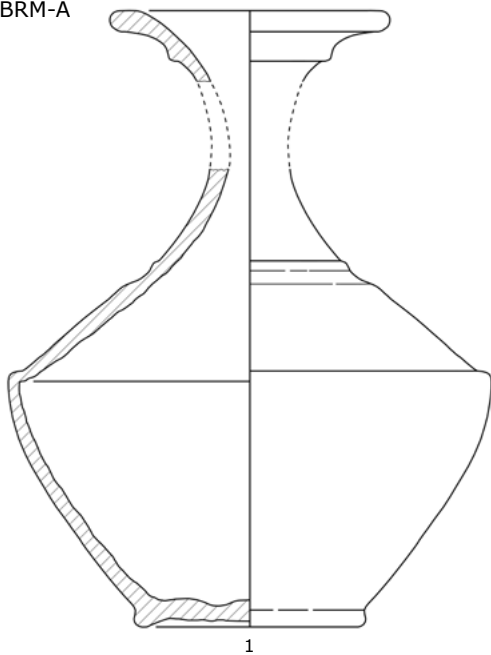

BRM-B

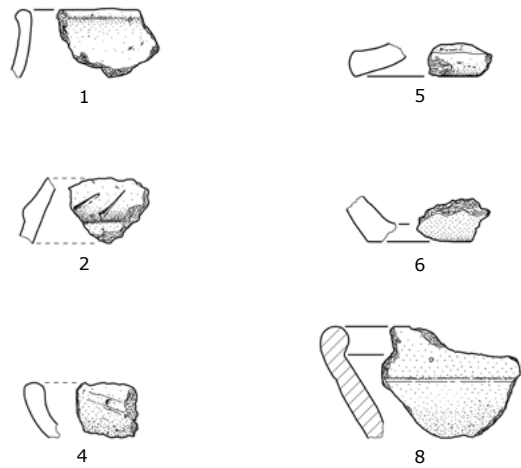

BRU

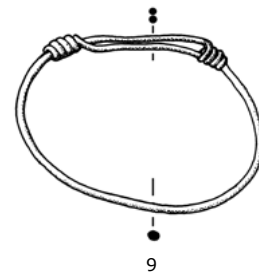
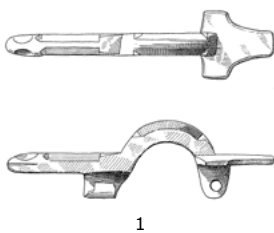

EBB

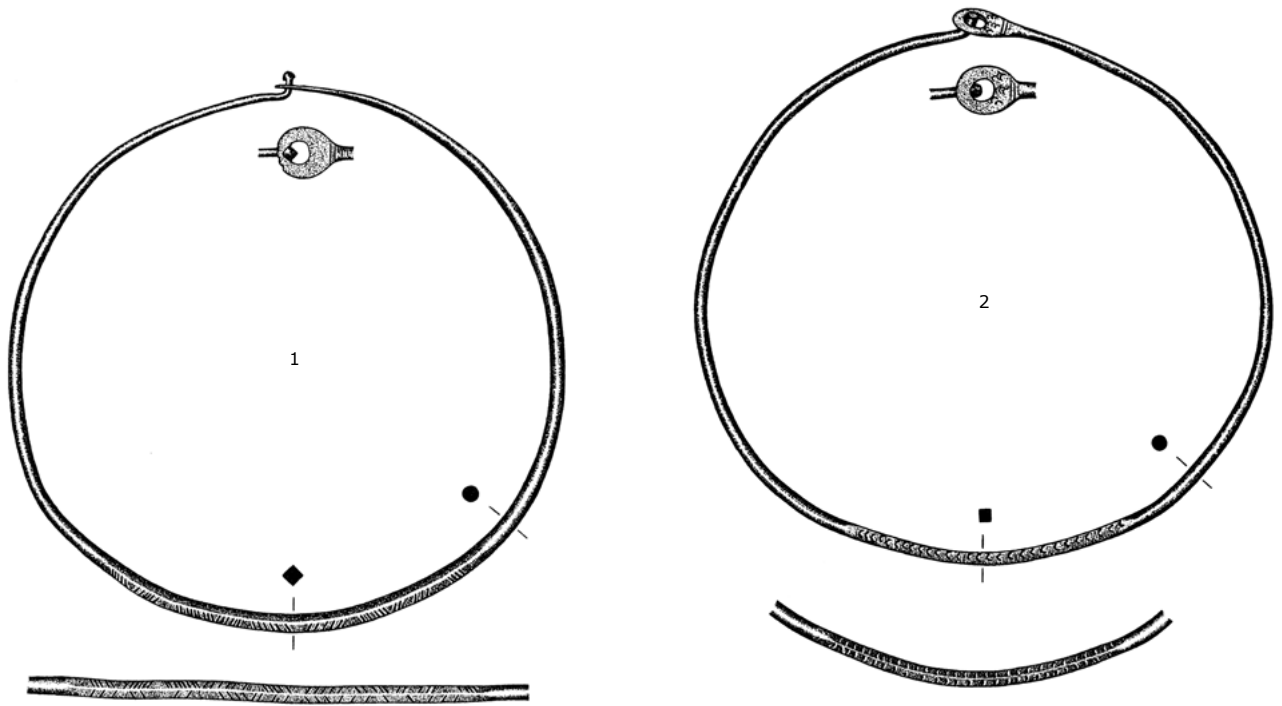

EGL

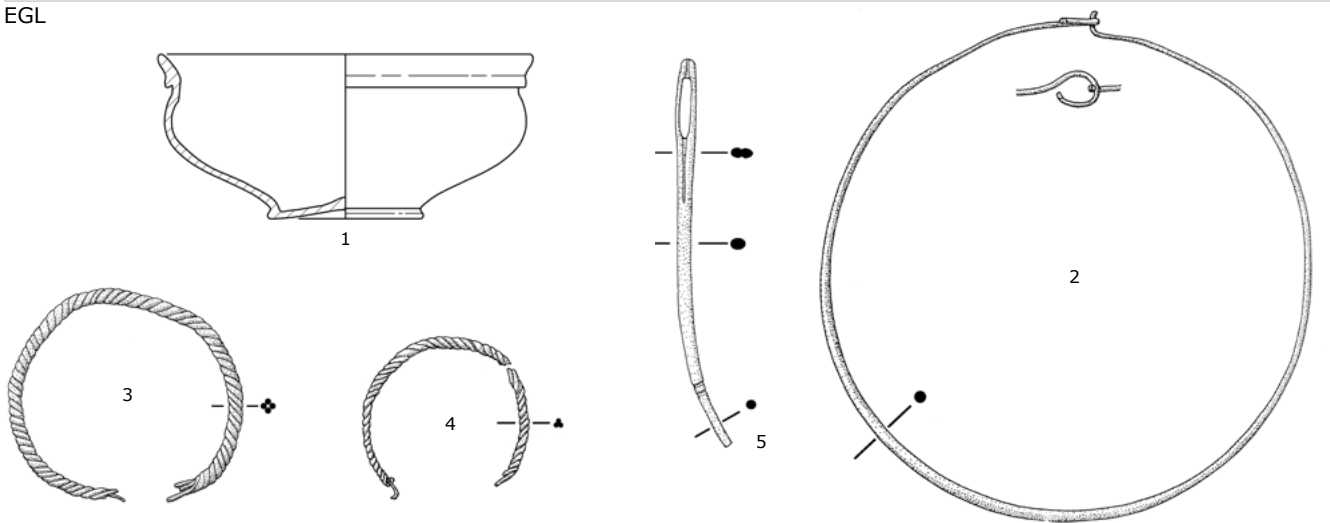

EPK-A

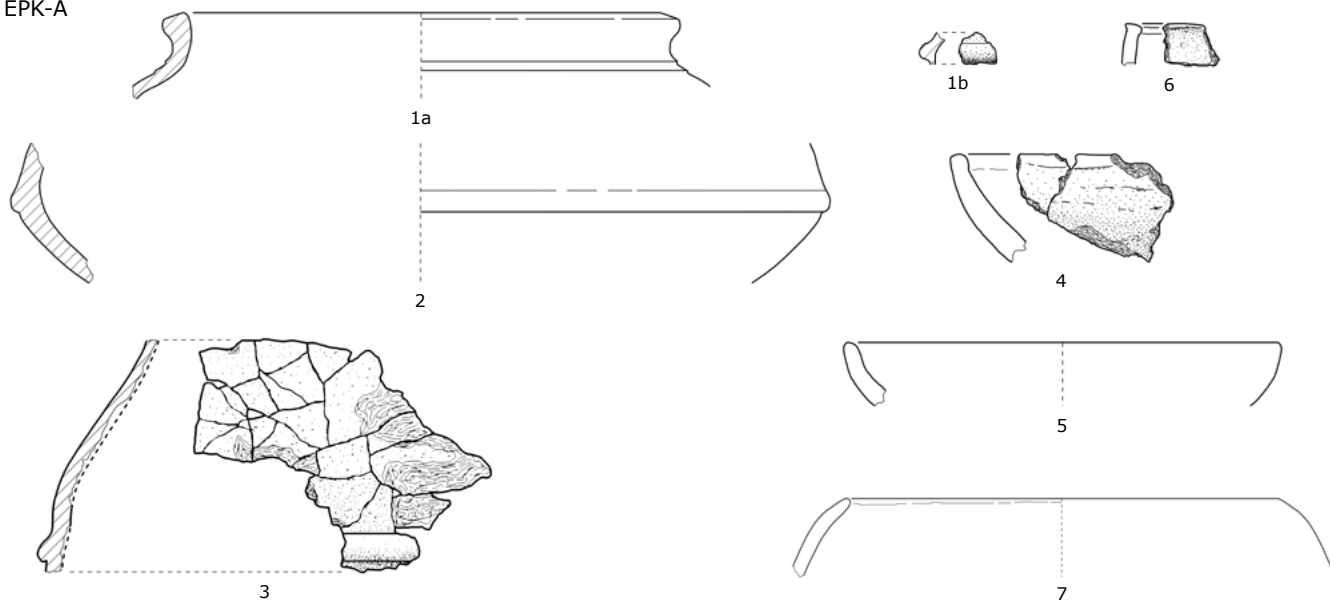

EPK-A

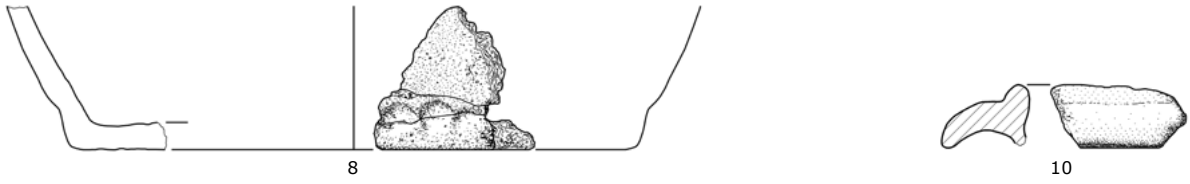

EPK-B

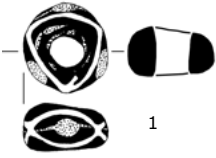

ETT-B



ETT-A



Foto von 1934

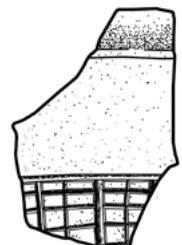

Versuch einer Umzeichnung

ESB

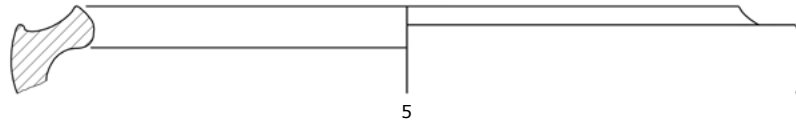
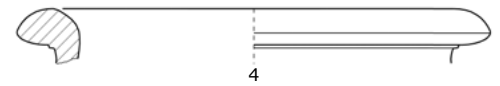
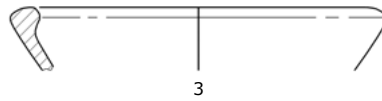
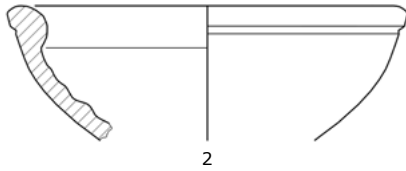

FÜR

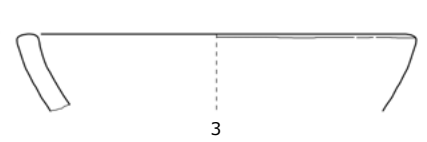
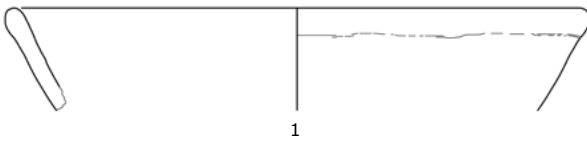

GEM BK 1

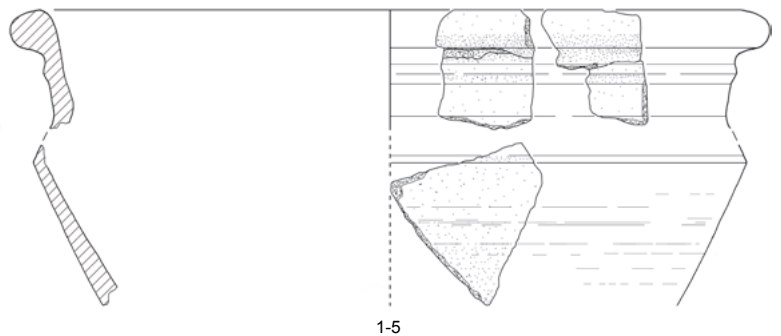
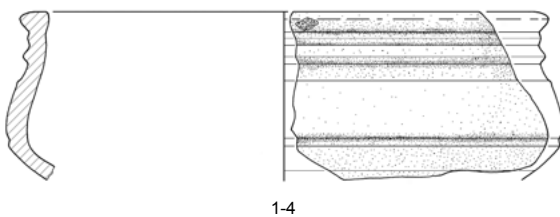
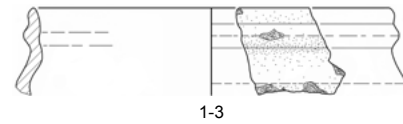
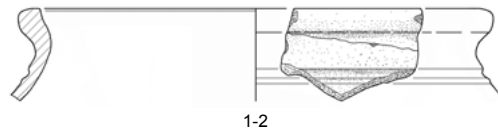
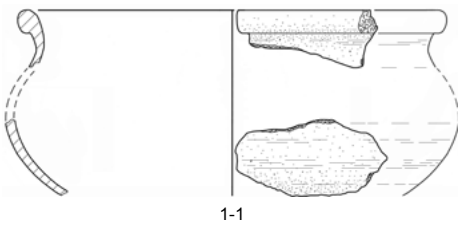

GEM BK 1

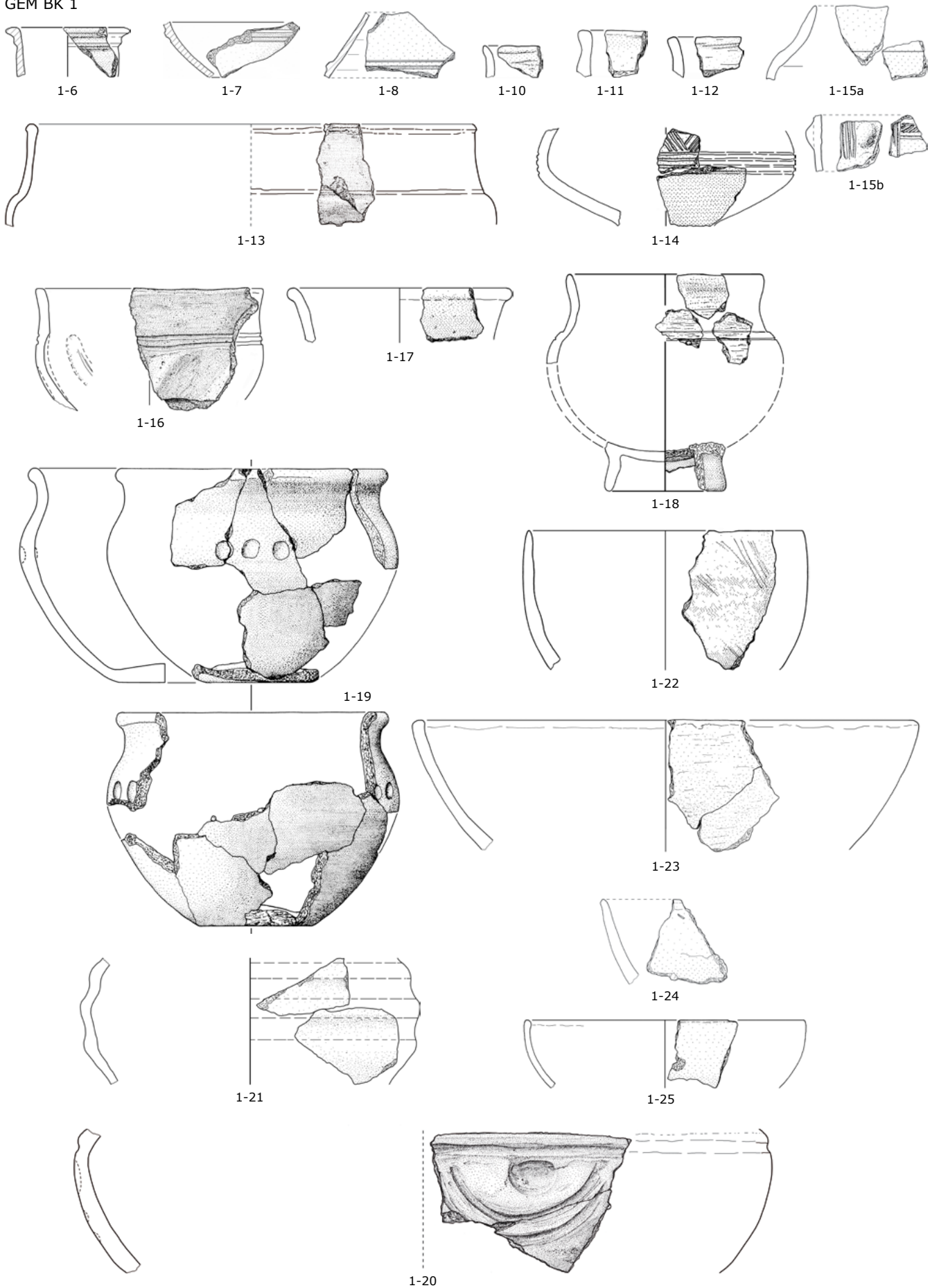

GEM BK 1

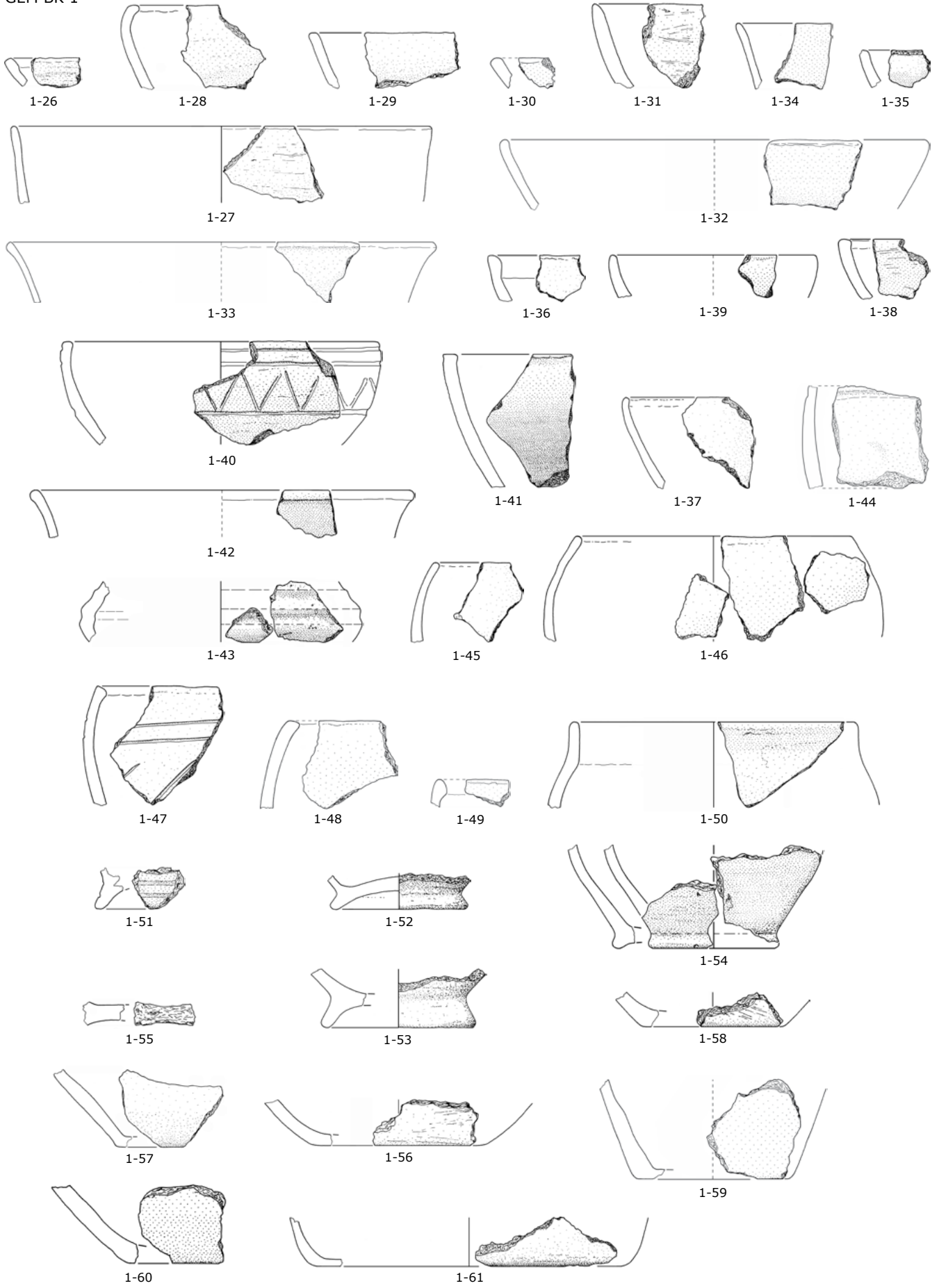

GEM BK 1

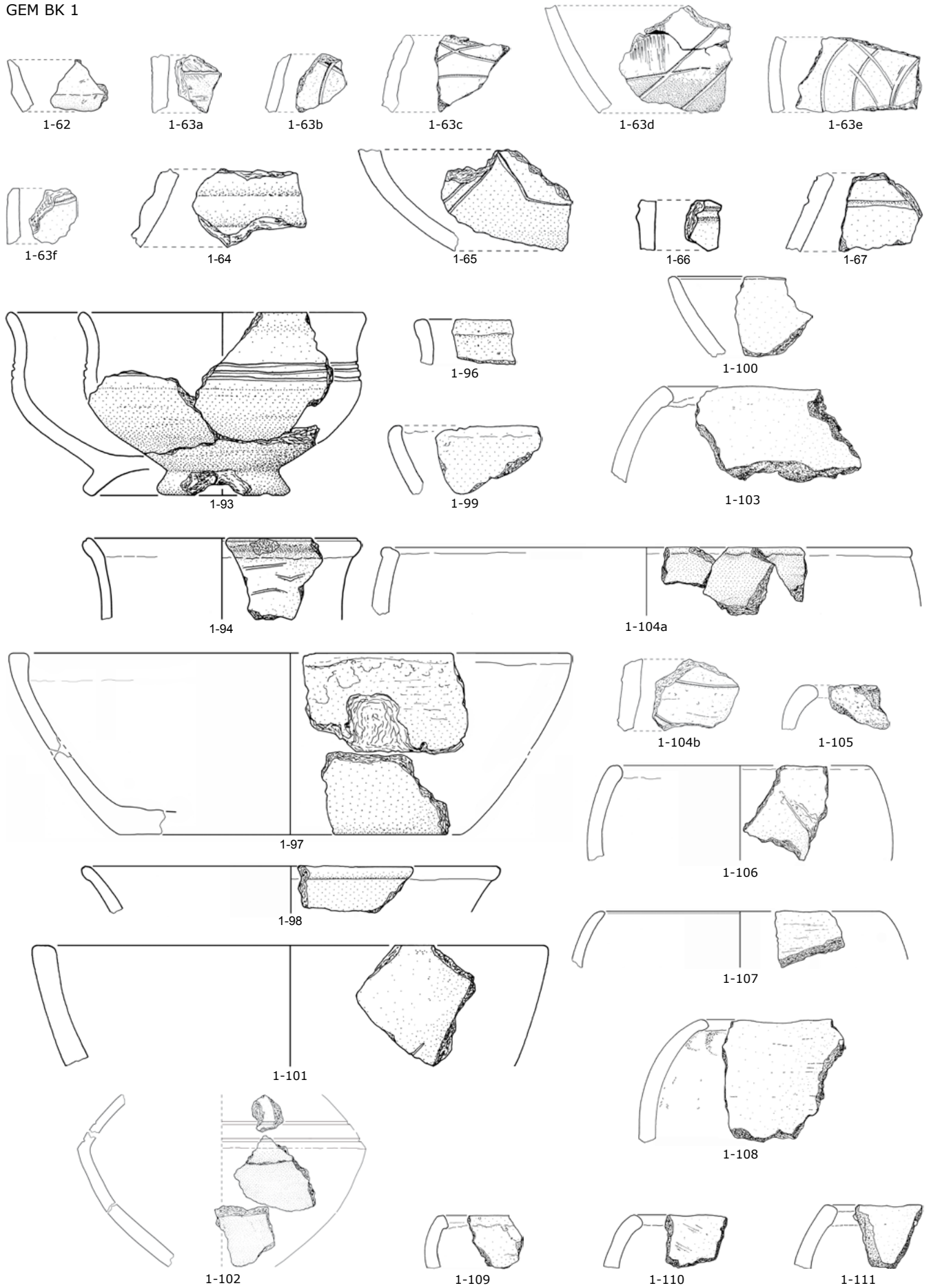

GEM BK 1



GEM BK 1

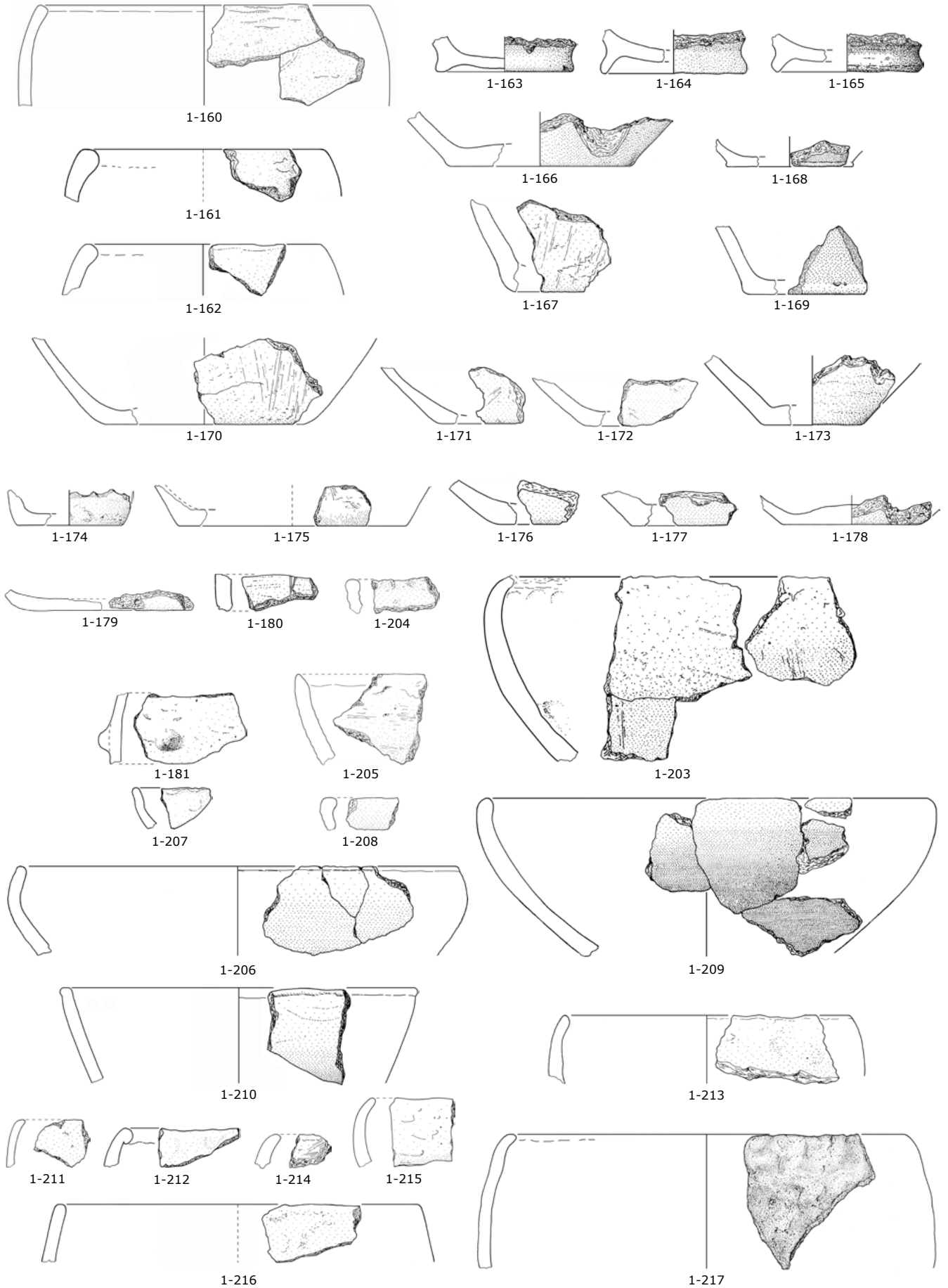

GEM BK 1

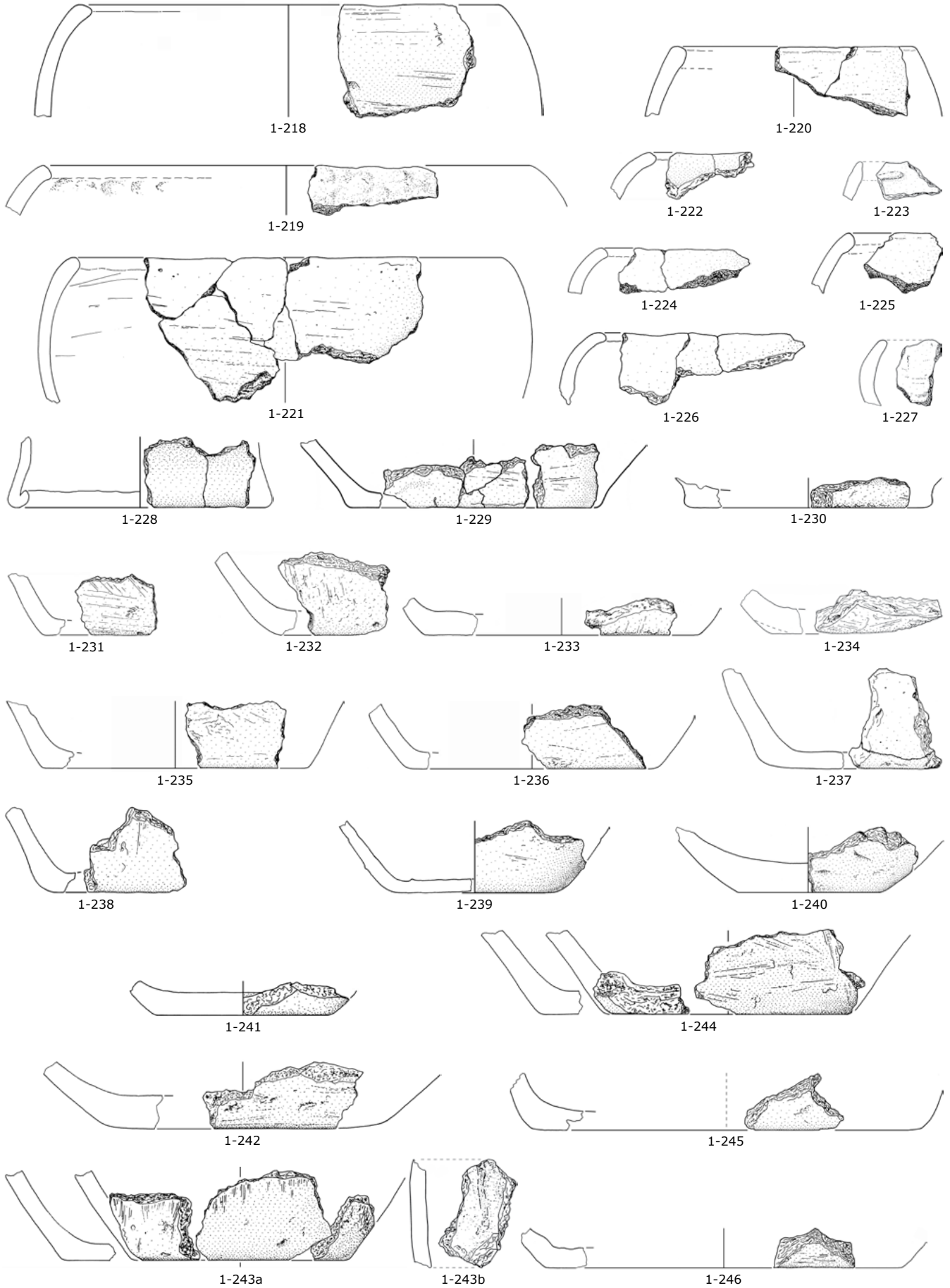

GEM BK 1

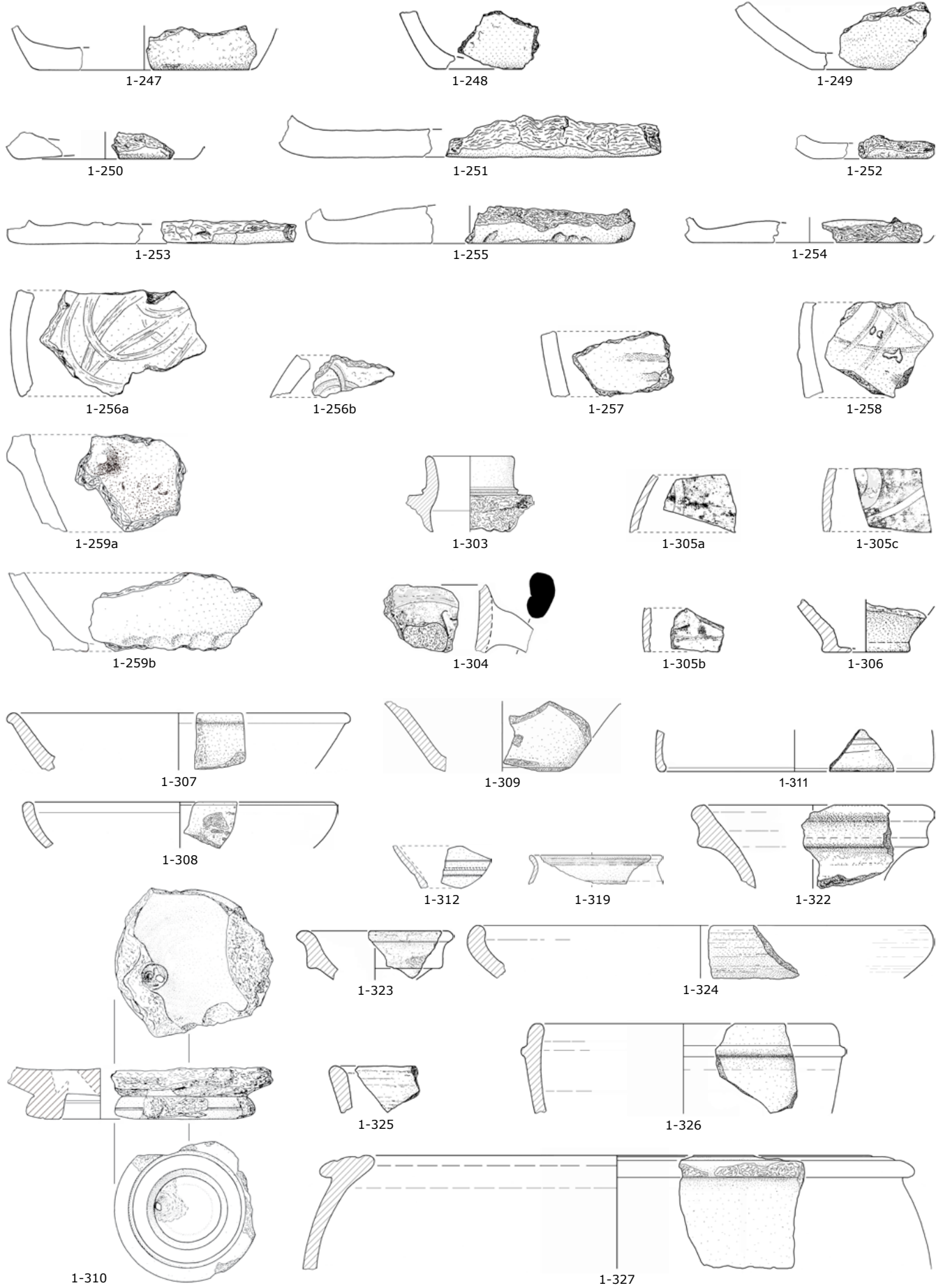

GEM BK 1

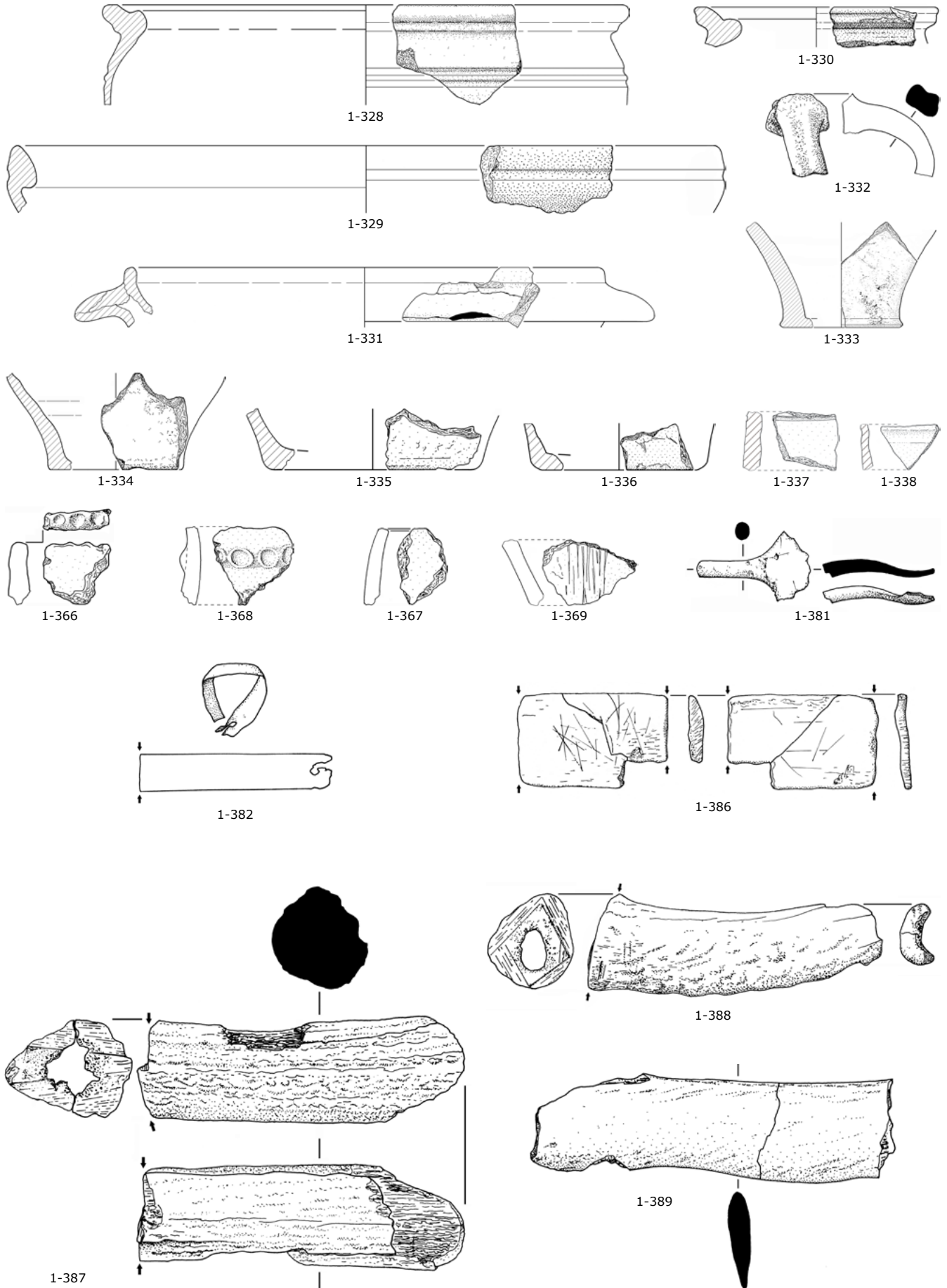

GEM BK 1

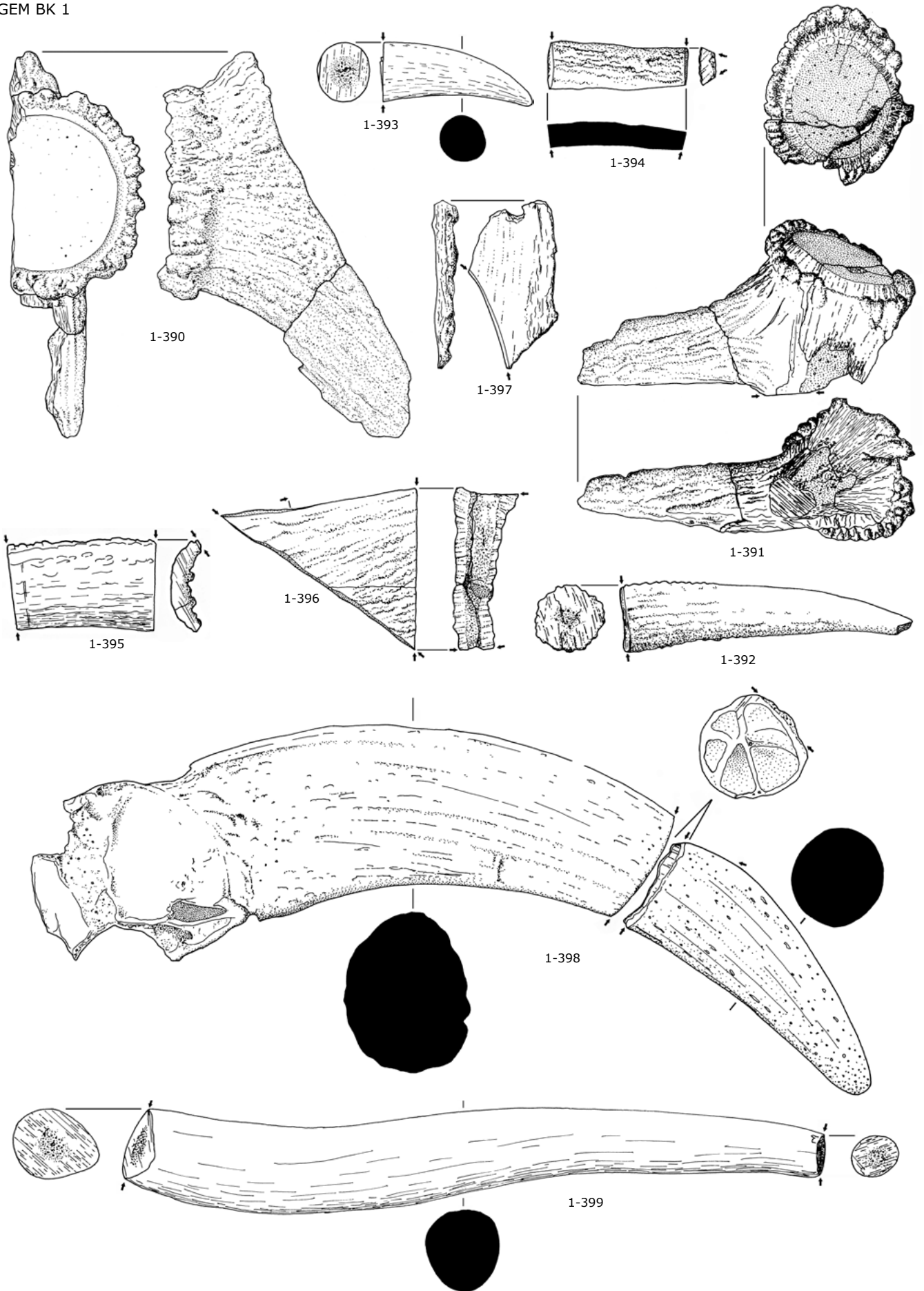

GEM BK 1

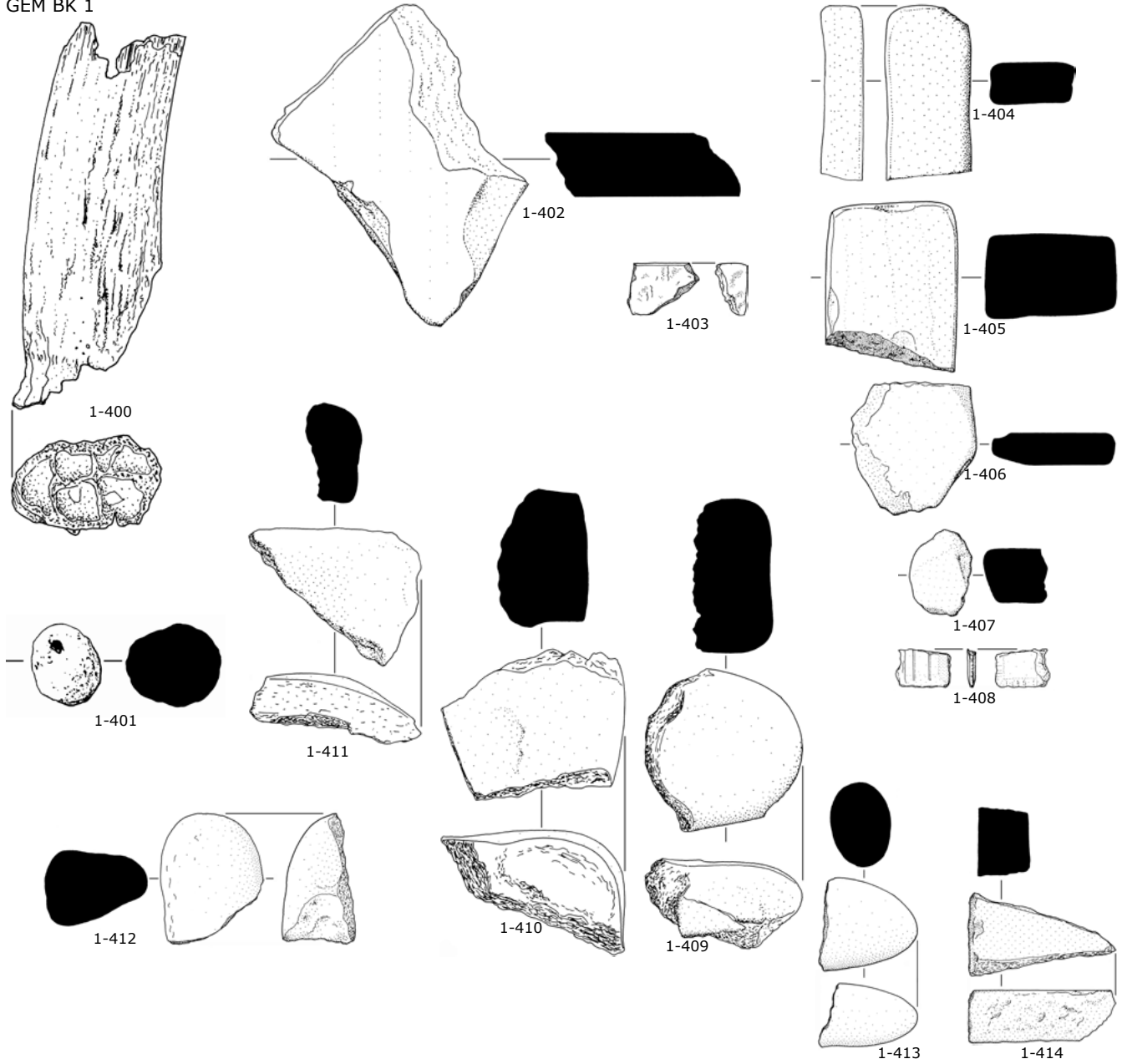

GEM BK 2

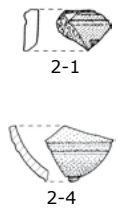

GEM BK 3

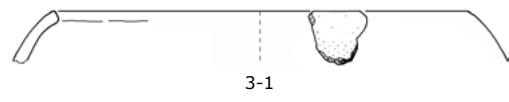

GEM BK 4

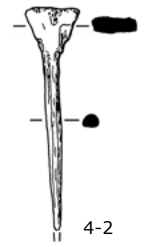

GÜG BK 2

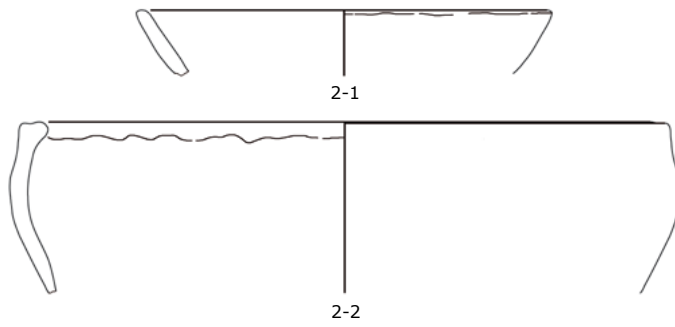

GÜG BK 6

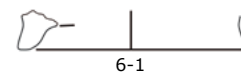

GÜG BK 3

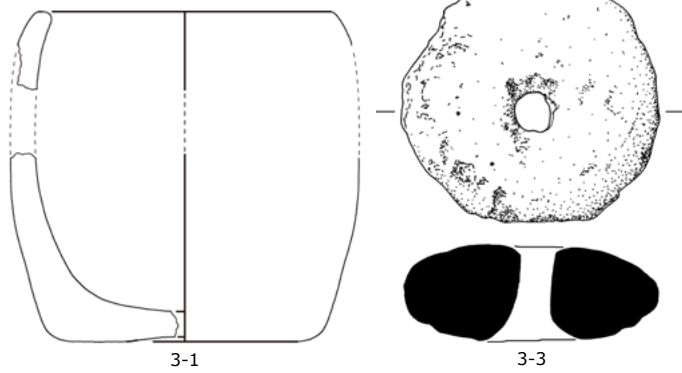

GÜG BK 7

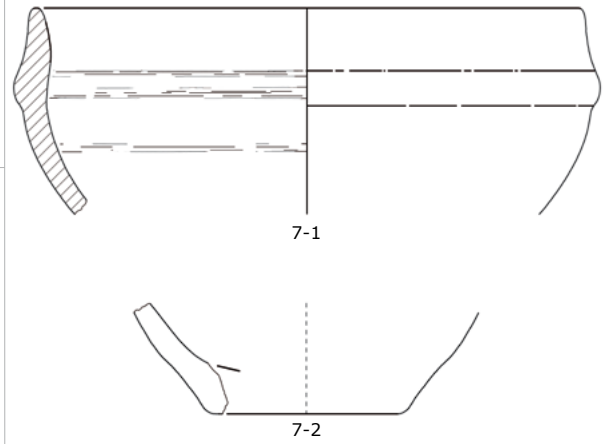

GÜG BK 5

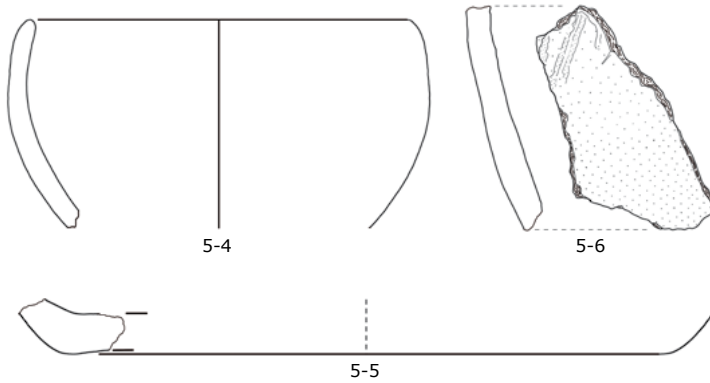

GÜG BK 8

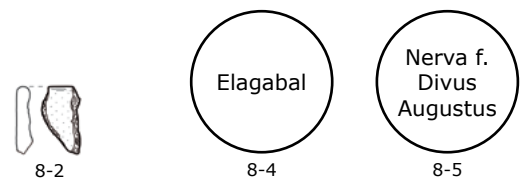

GÜG BK 9

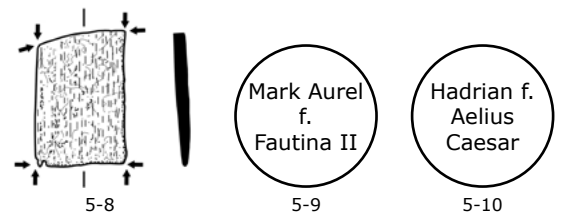

GÜG BK 11

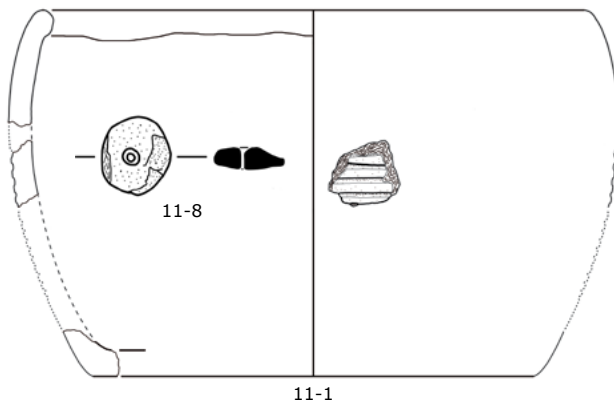

GÜG BK 12

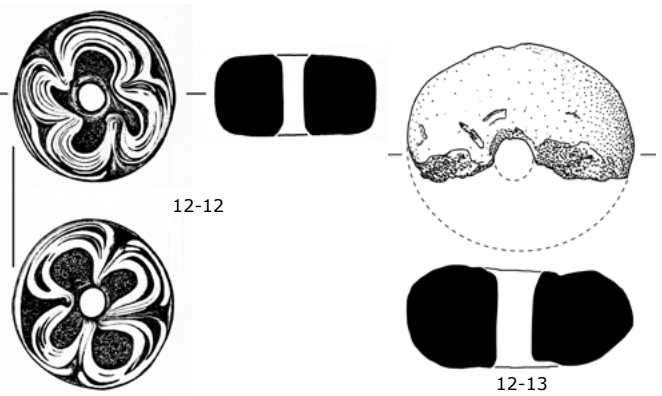

GÜG BK 13

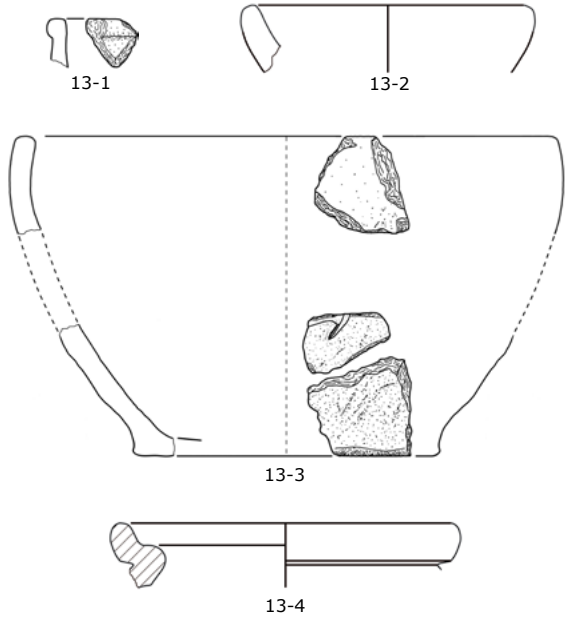

GÜG BK 17

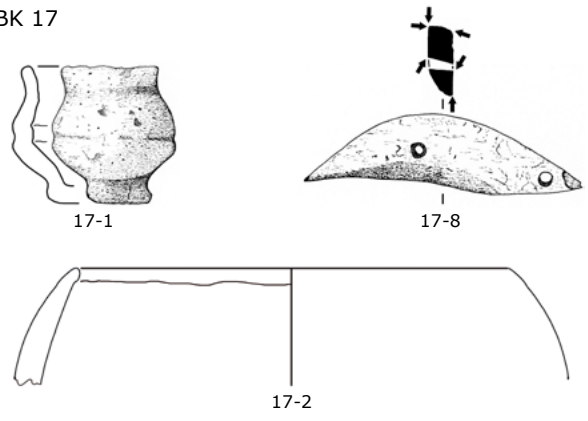

GÜG BK 18



GÜG BK 19



GÜG BK 20

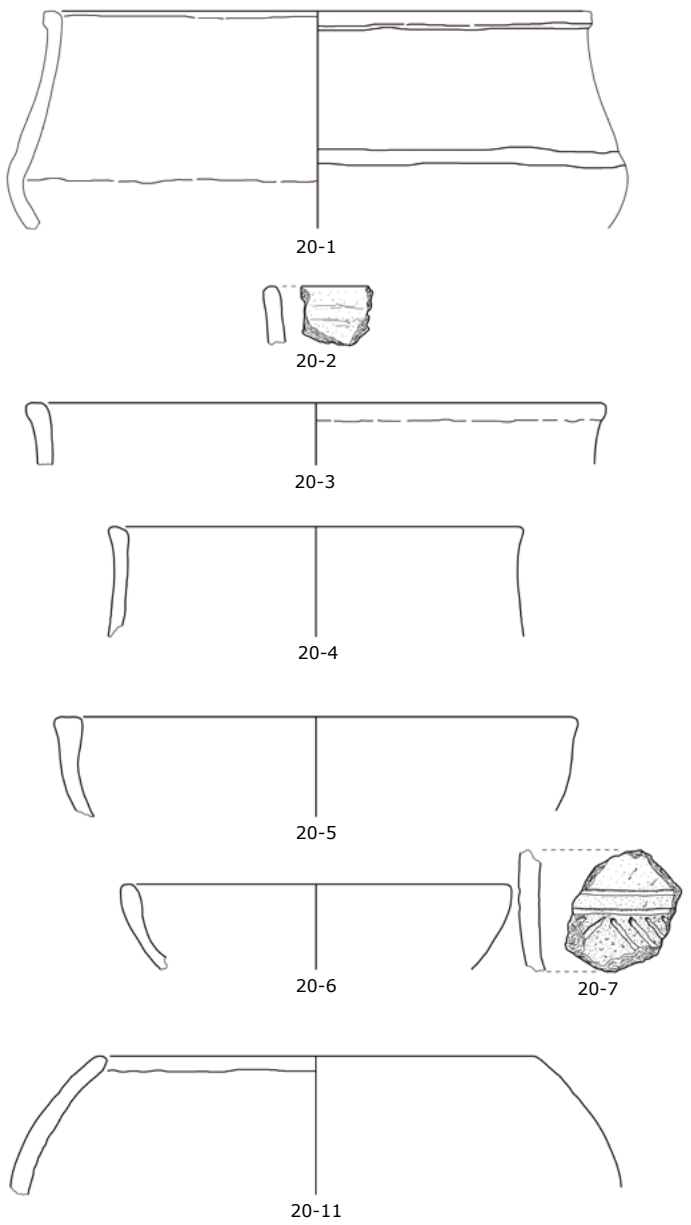

GÜG BK 15

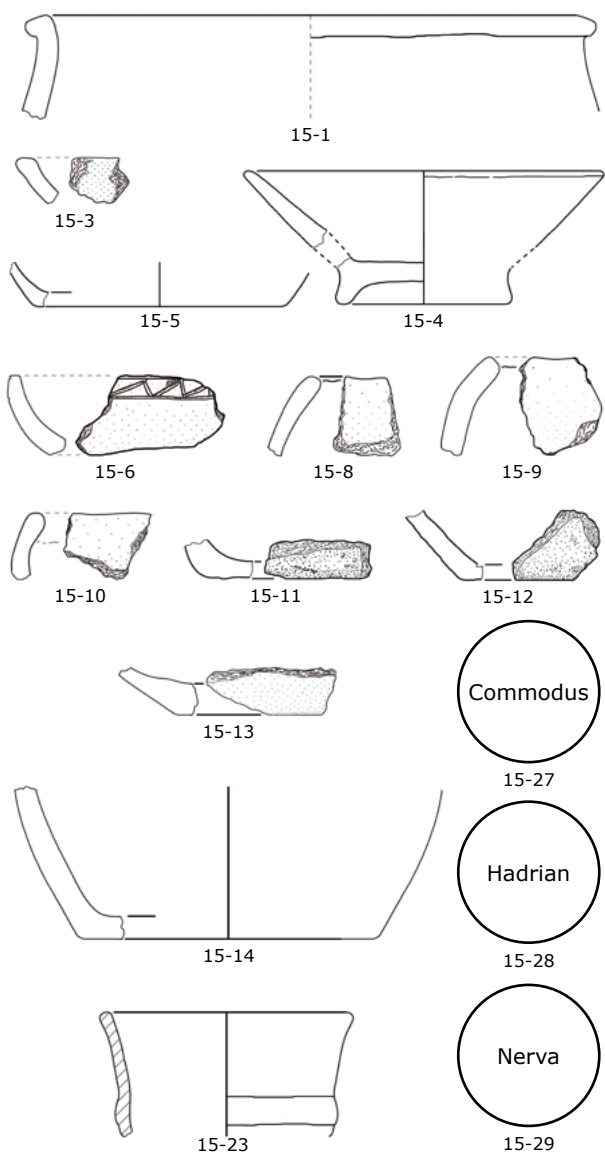

Commodus
15-27

Hadrian
15-28

Nerva
15-29

Güglingen. GÜG-17-8 M. 1:2, GÜG-20-1 M. 1:4, sonst M. 1:3.

GÜG BK 20

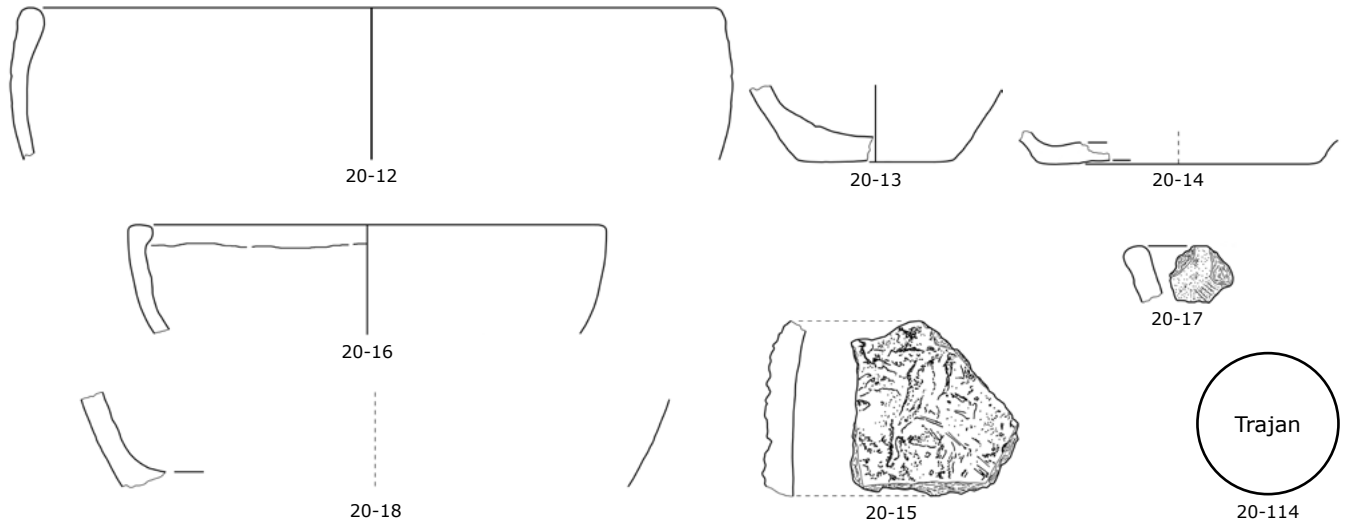

GÜG BK 21

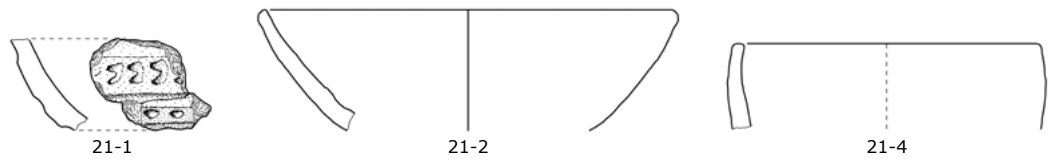

GÜG BK 23

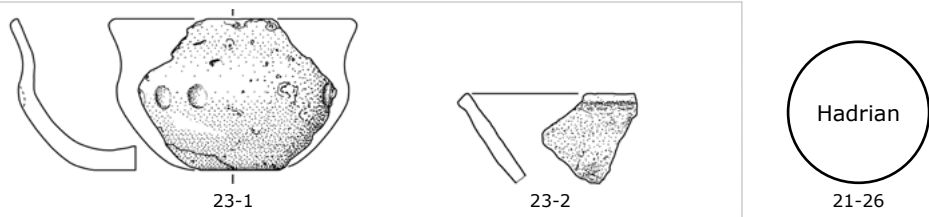

GÜG BK 24

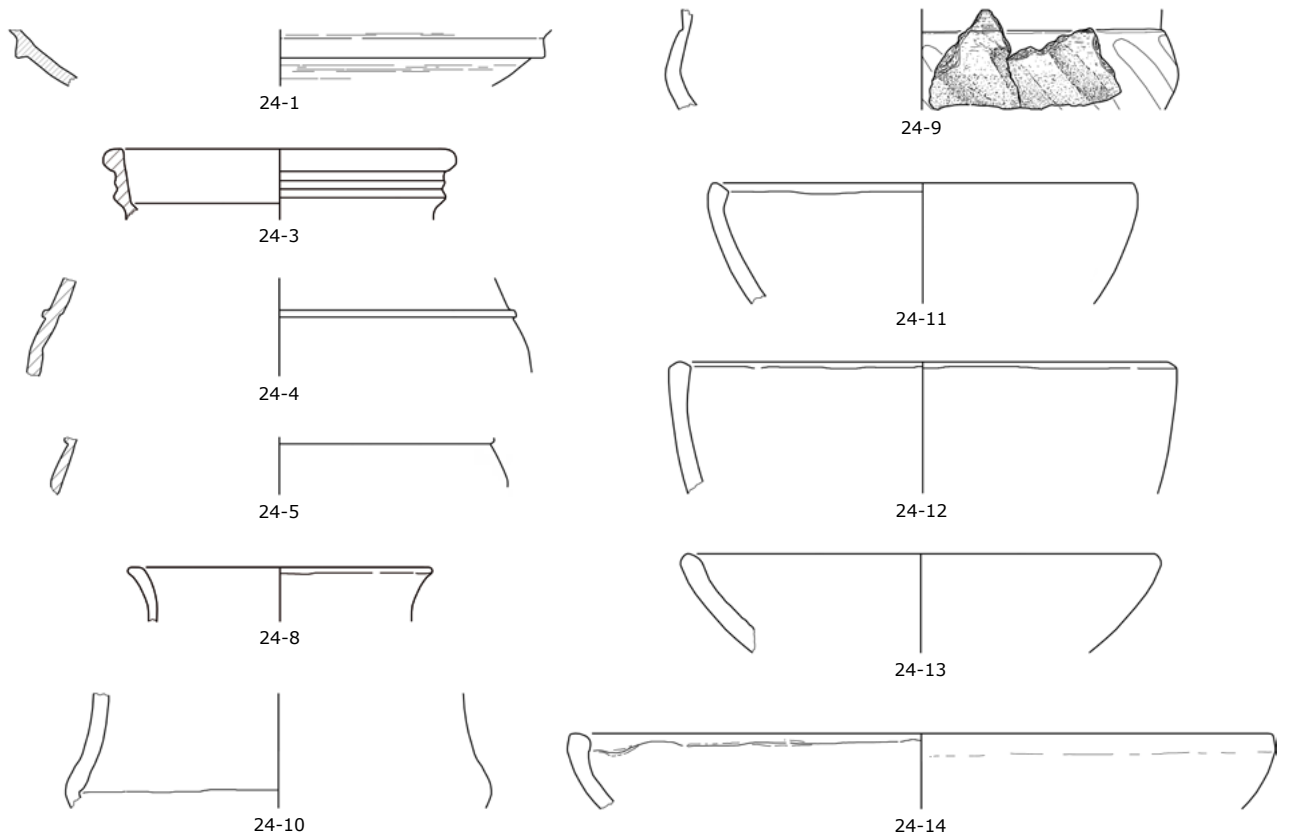

GÜG BK 24

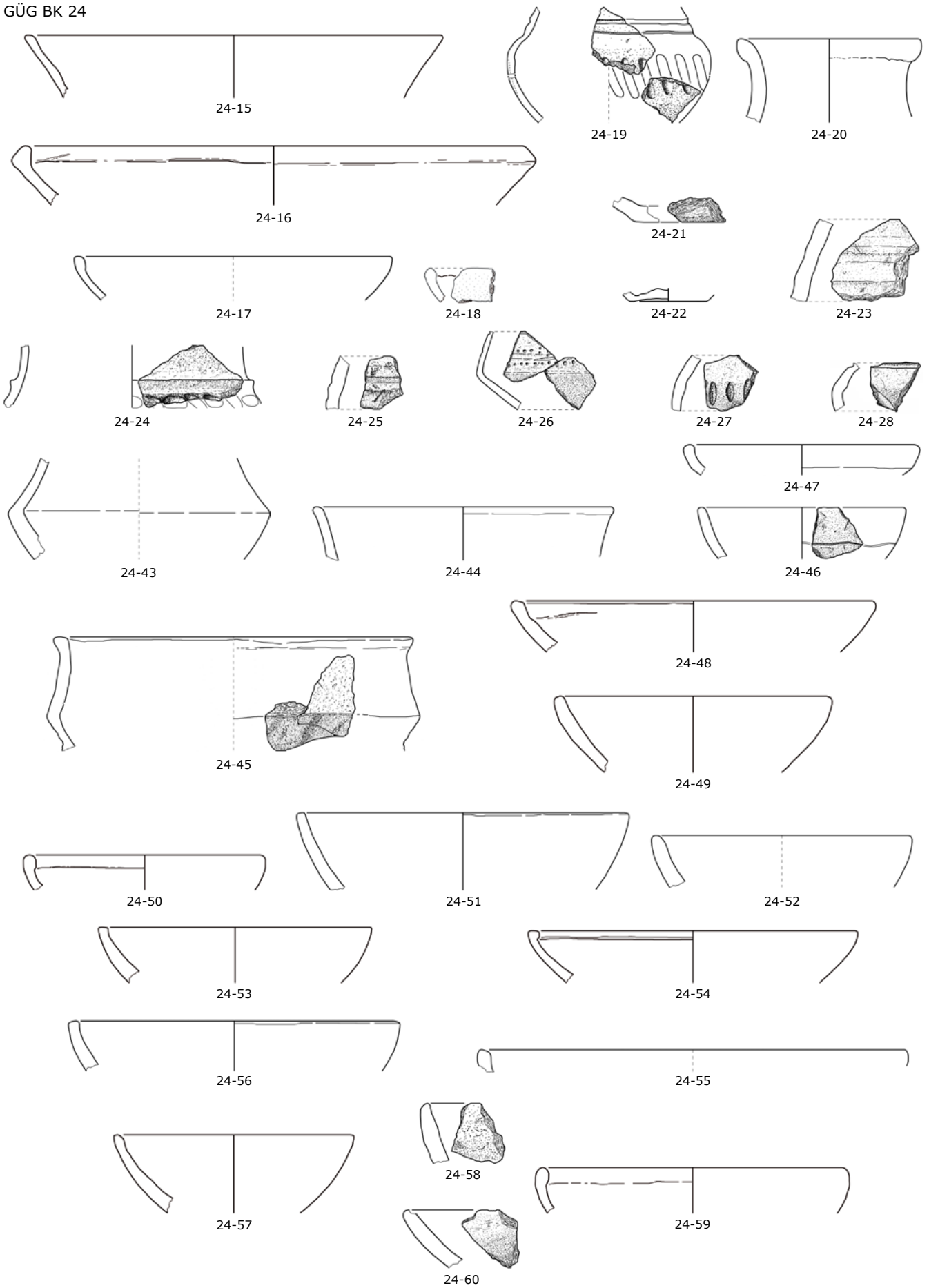

GÜG BK 24

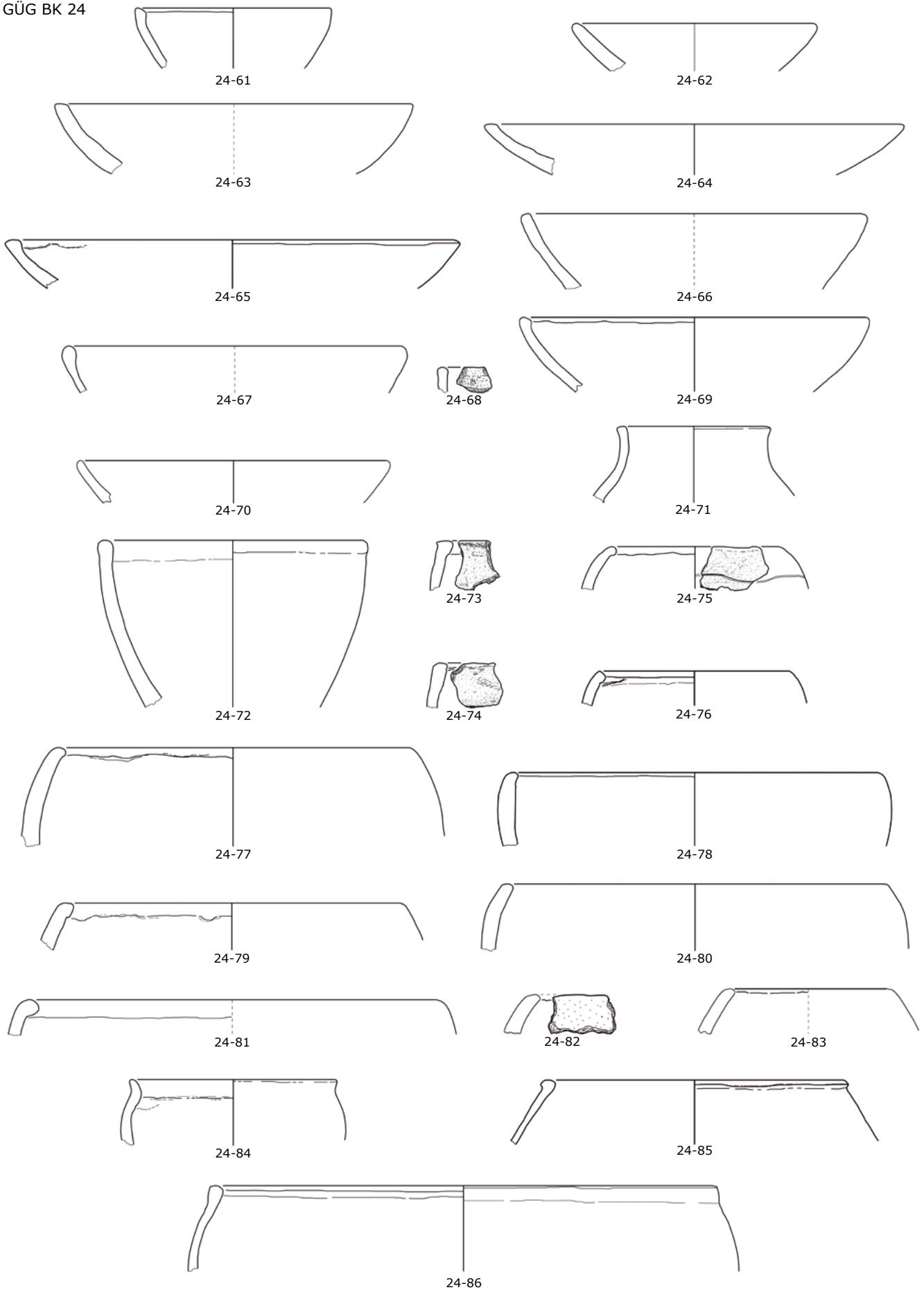

GÜG BK 24

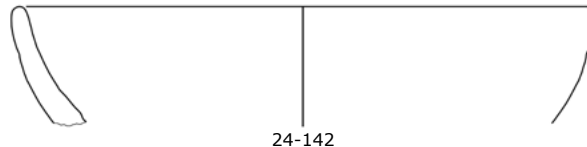
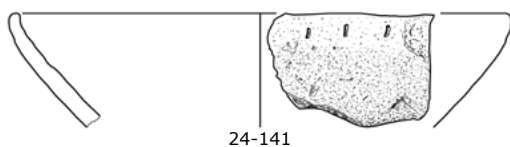
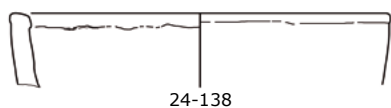
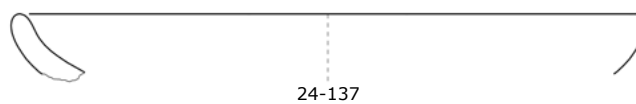
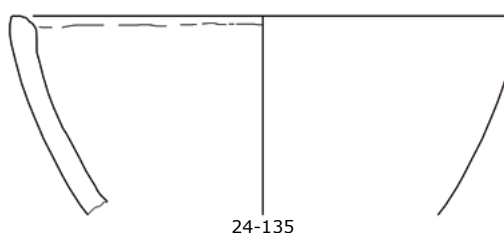
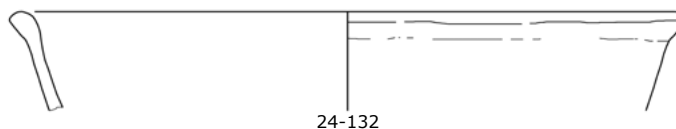
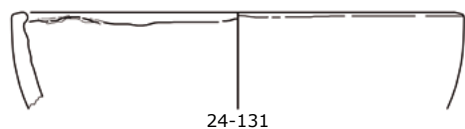
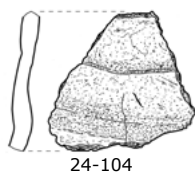
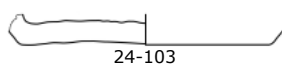
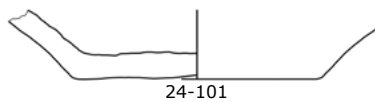
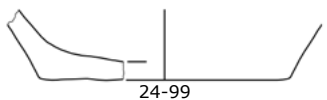
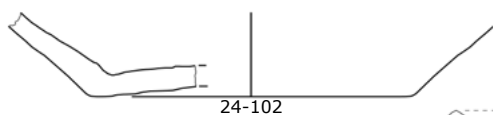
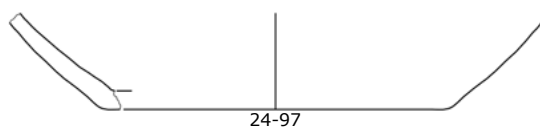
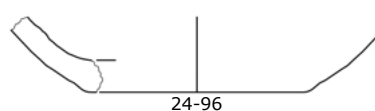
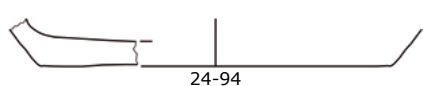
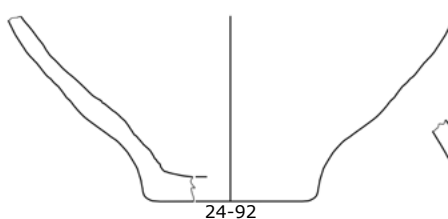
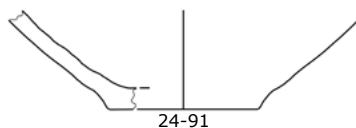
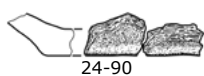
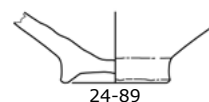
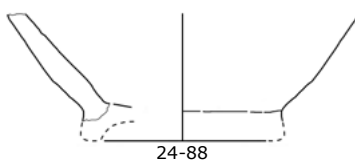
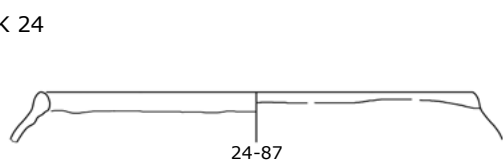

GÜG BK 24

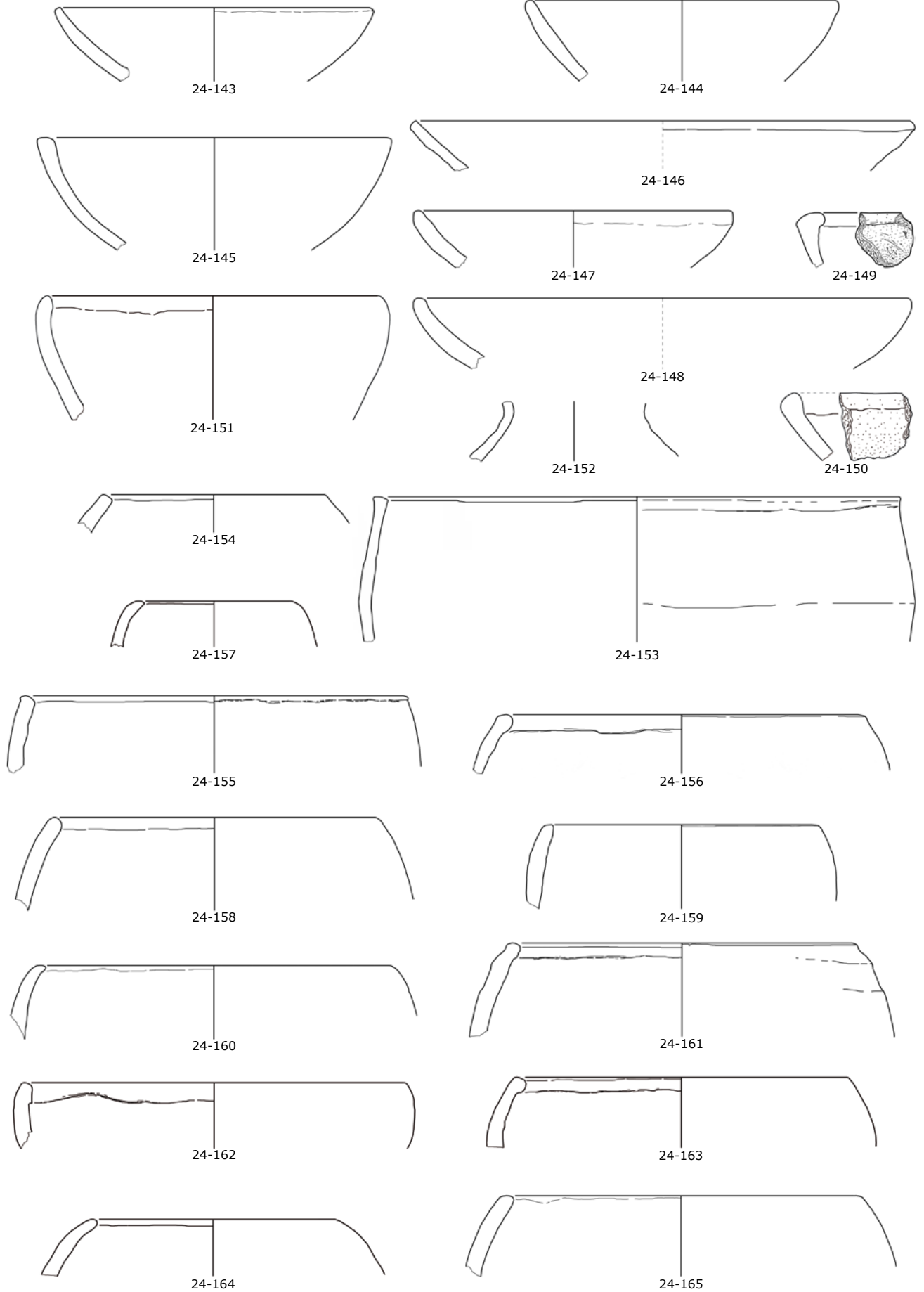

GÜG BK 24

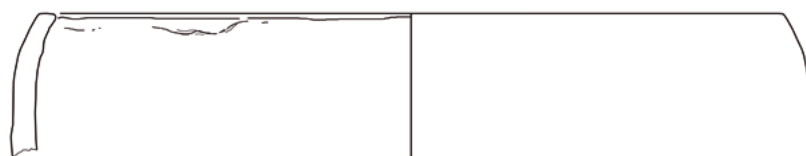

24-166



24-168

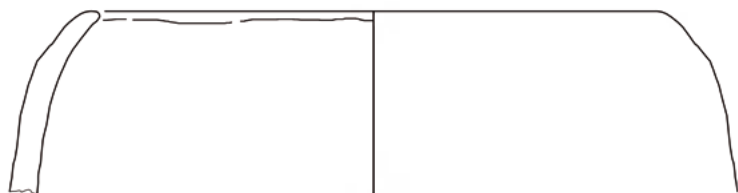

24-167

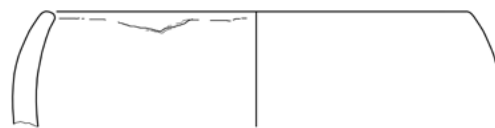

24-169

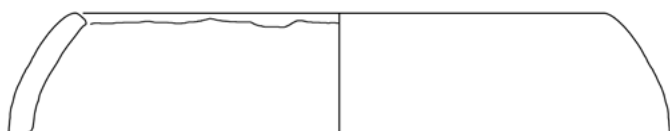

24-170



24-171

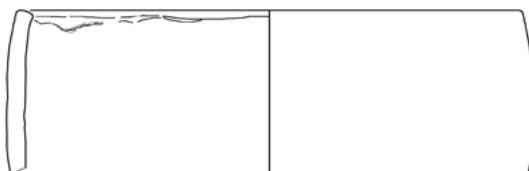

24-174



24-173



24-172

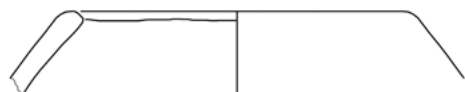

24-175

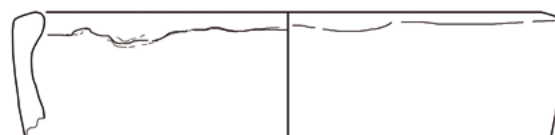

24-176

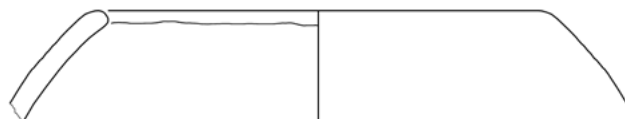

24-177

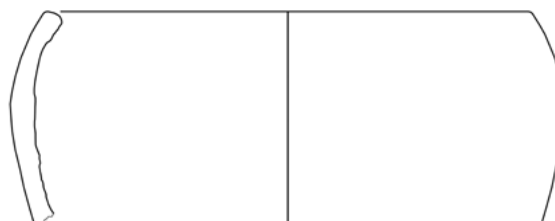

24-178



24-179

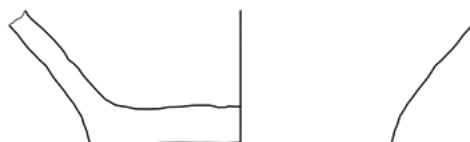

24-181



24-185



24-180



24-182



24-186



24-183



24-184



24-188



24-187



24-189



24-191



24-190

GÜG BK 24

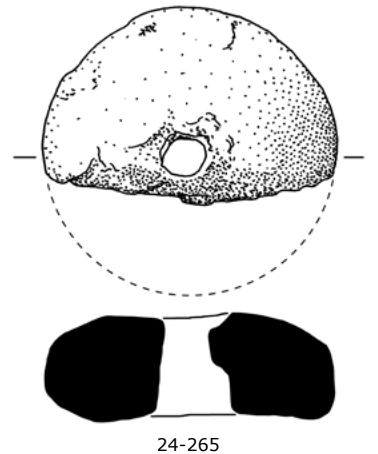
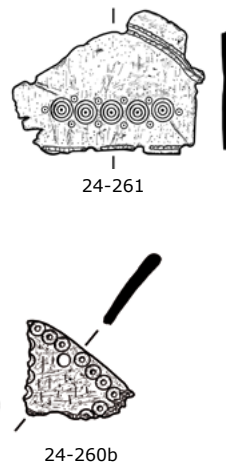
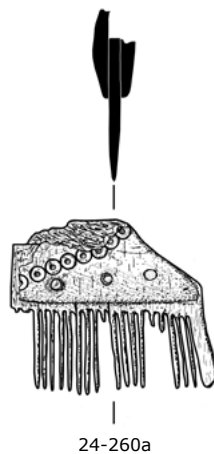
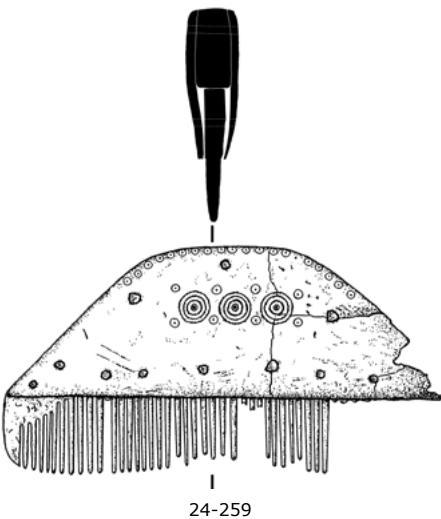
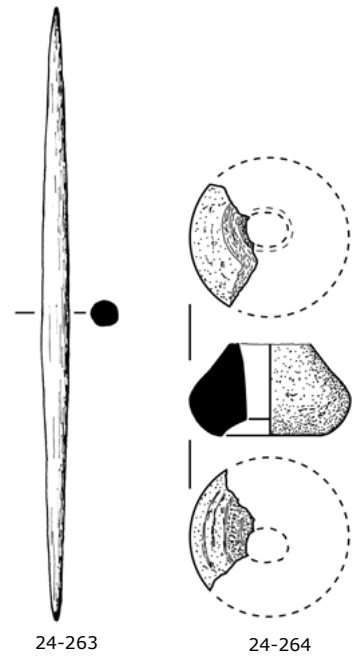
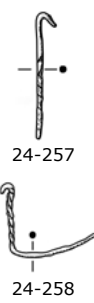
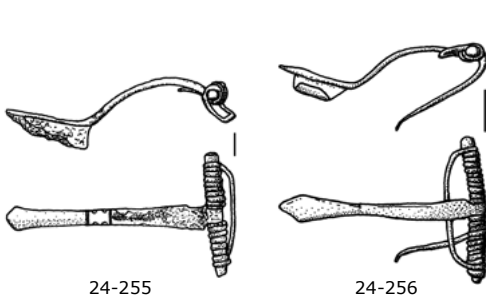
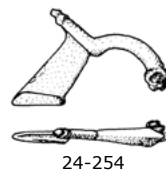
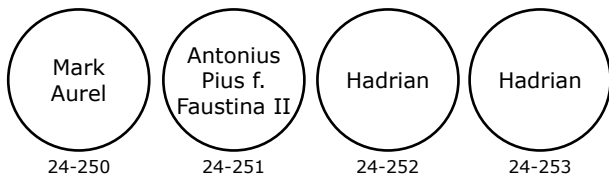
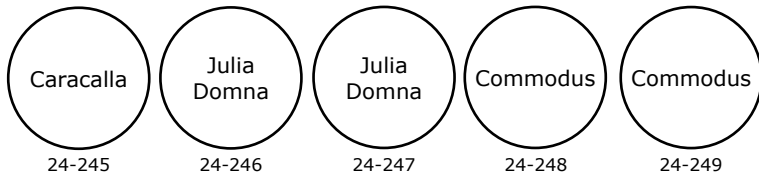
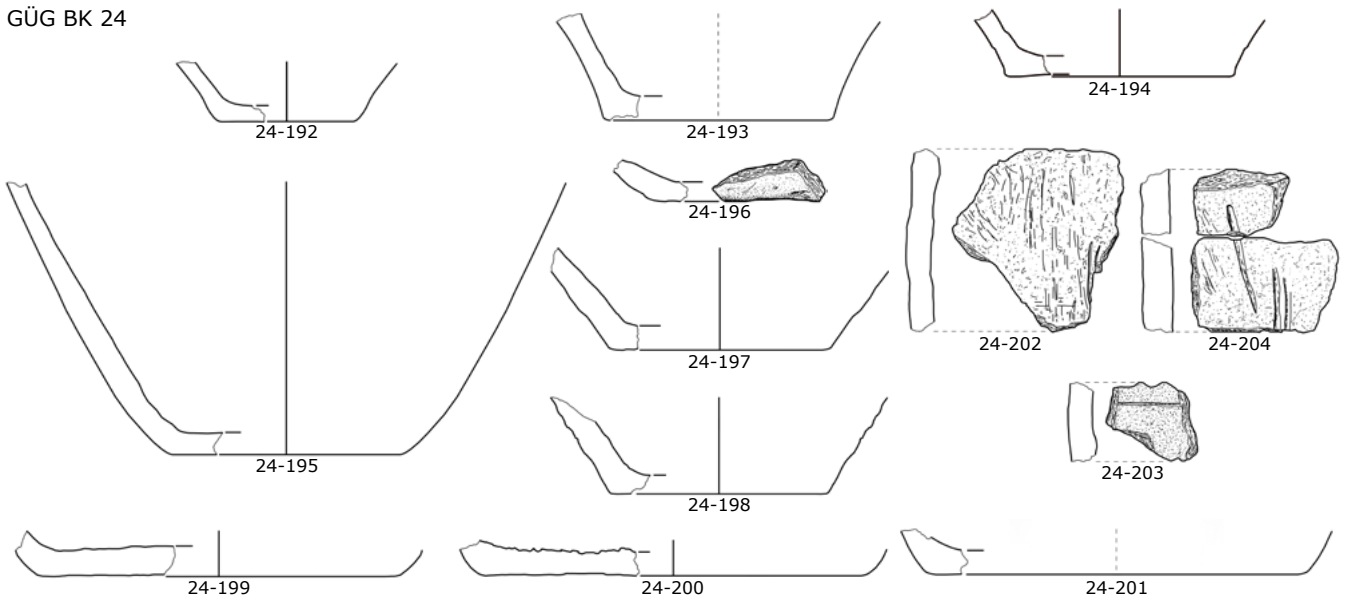

GÜG BK 25

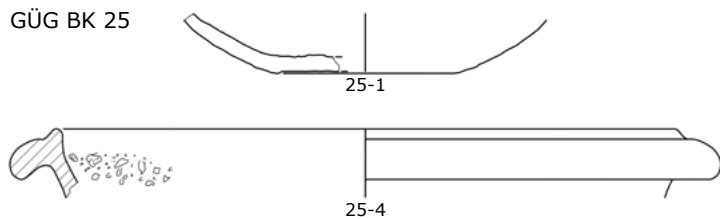

GÜG BK 26

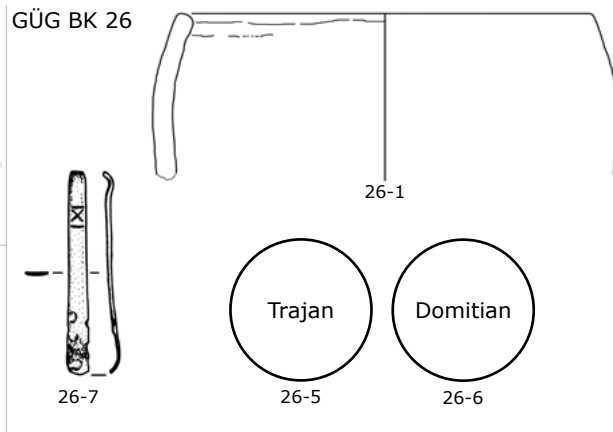

GÜG BK 27

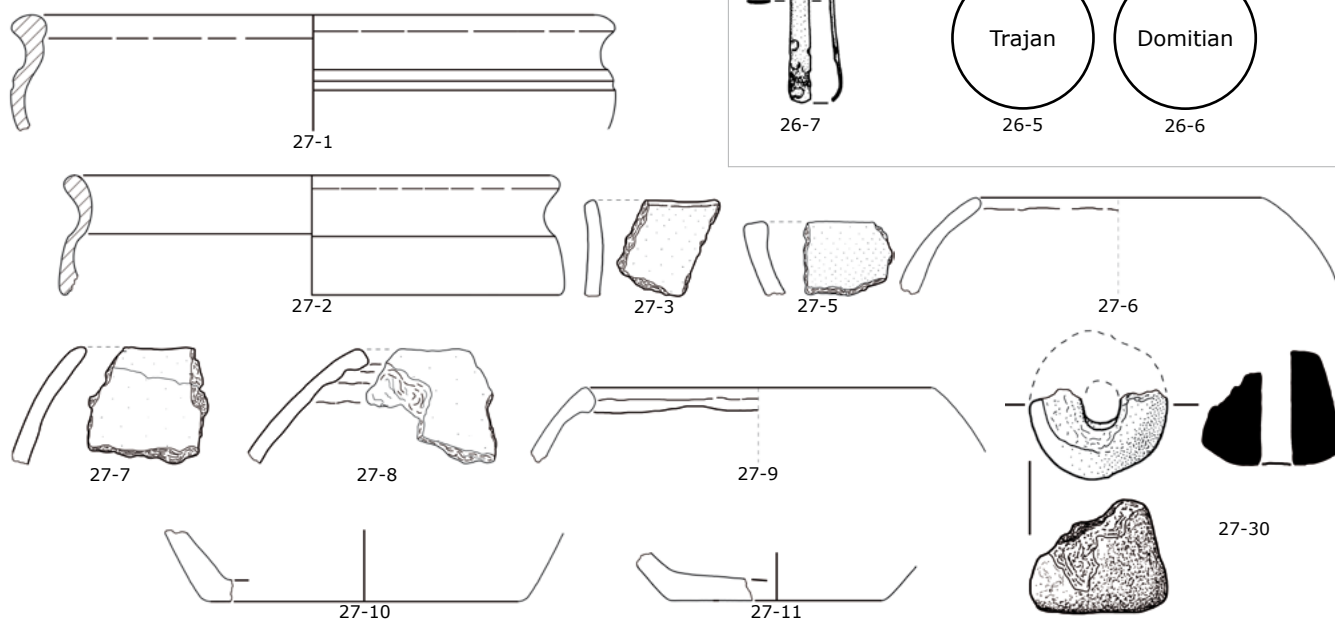

GÜG BK 28



GÜG BK 29



GÜG BK 29

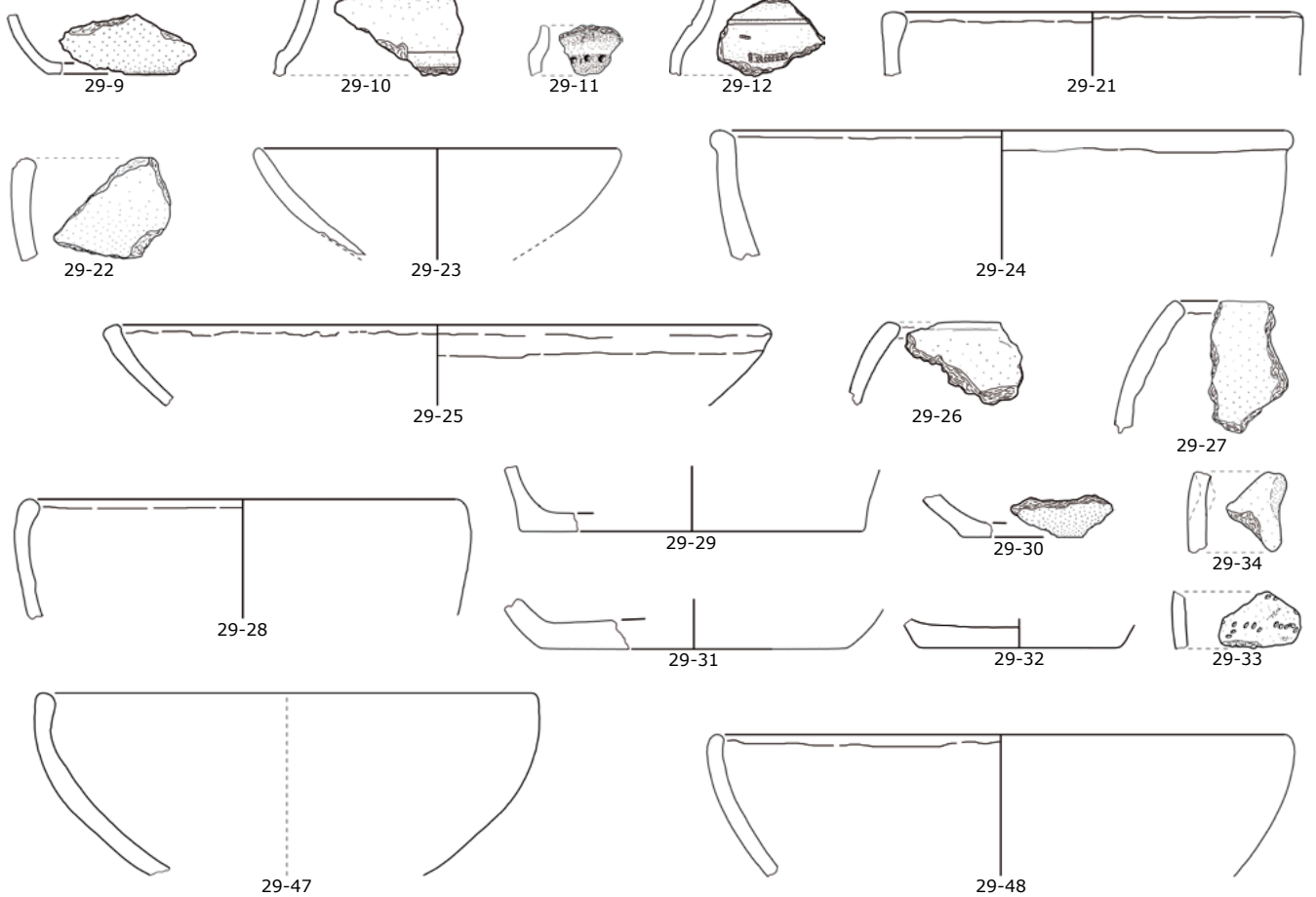

GÜG BK 30

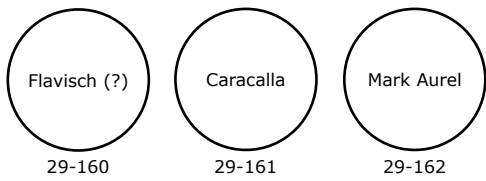
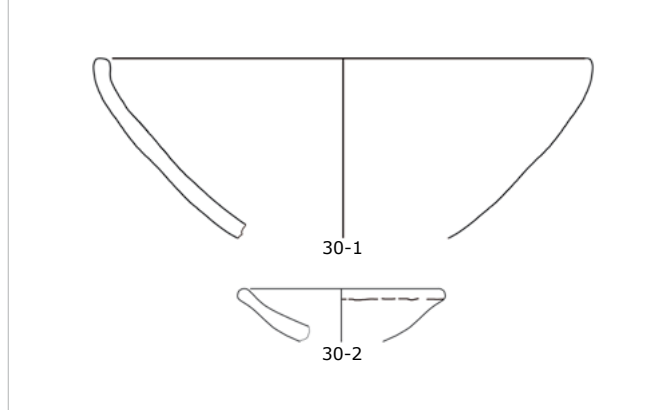

GÜG BK 31

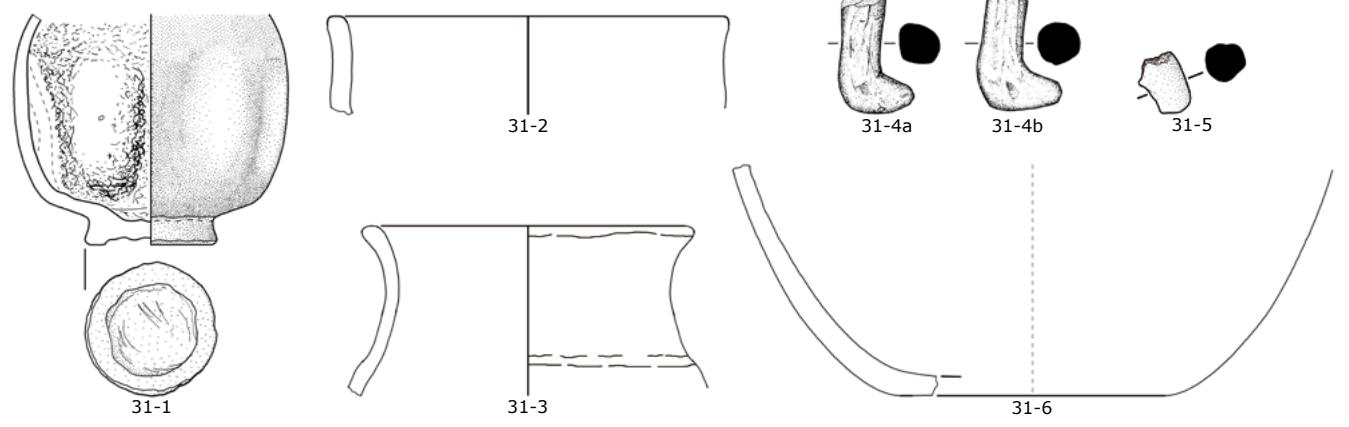

GÜG BK 31

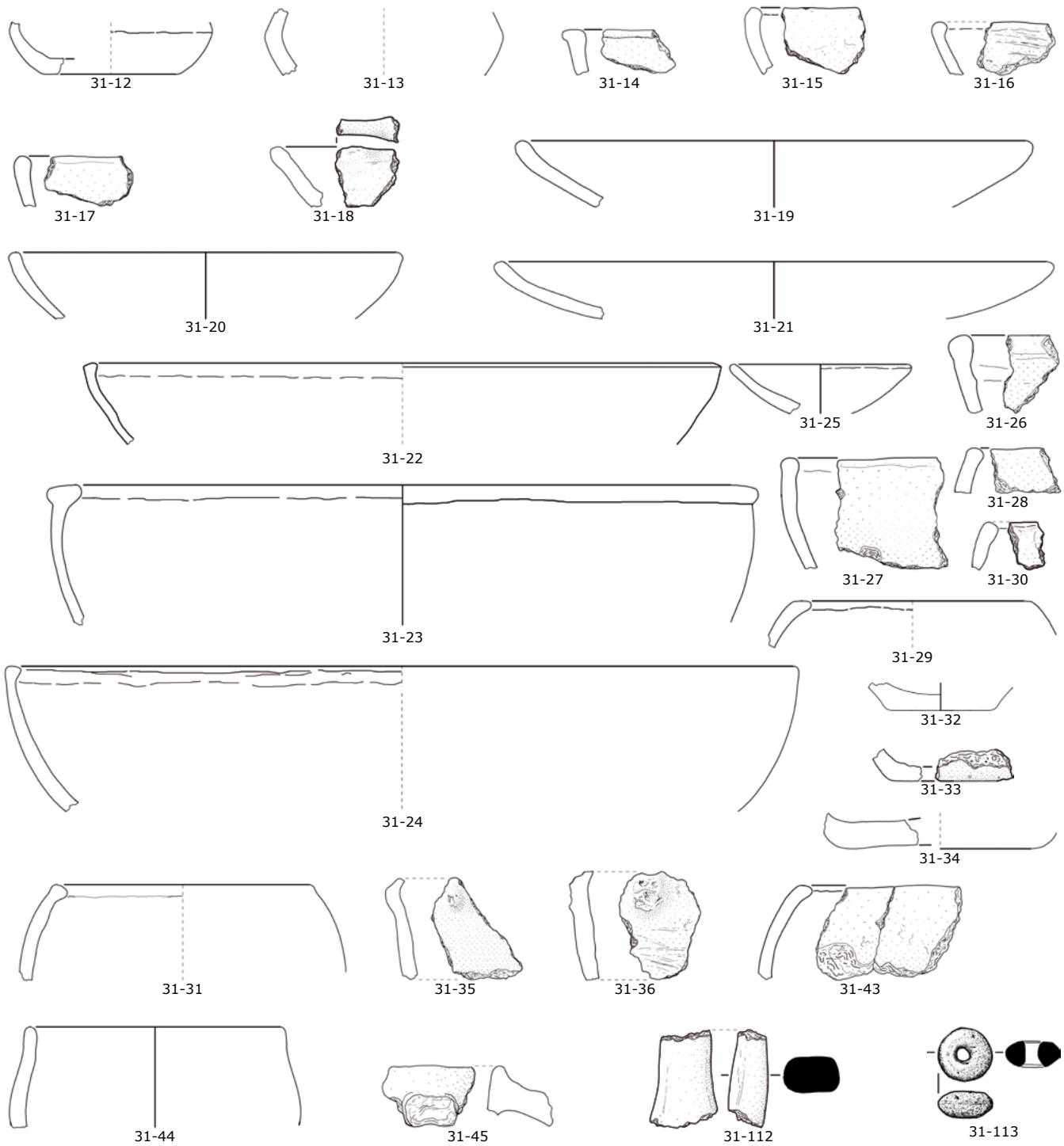

GÜG BK 32

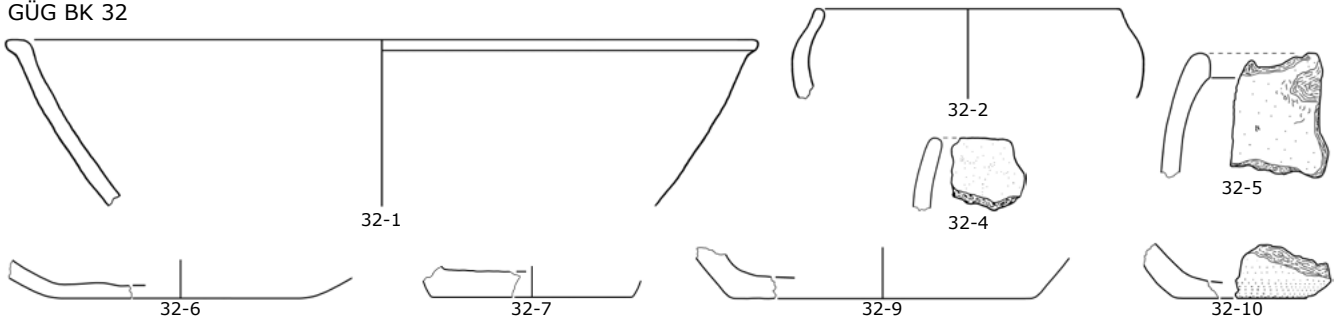

GÜG BK 33

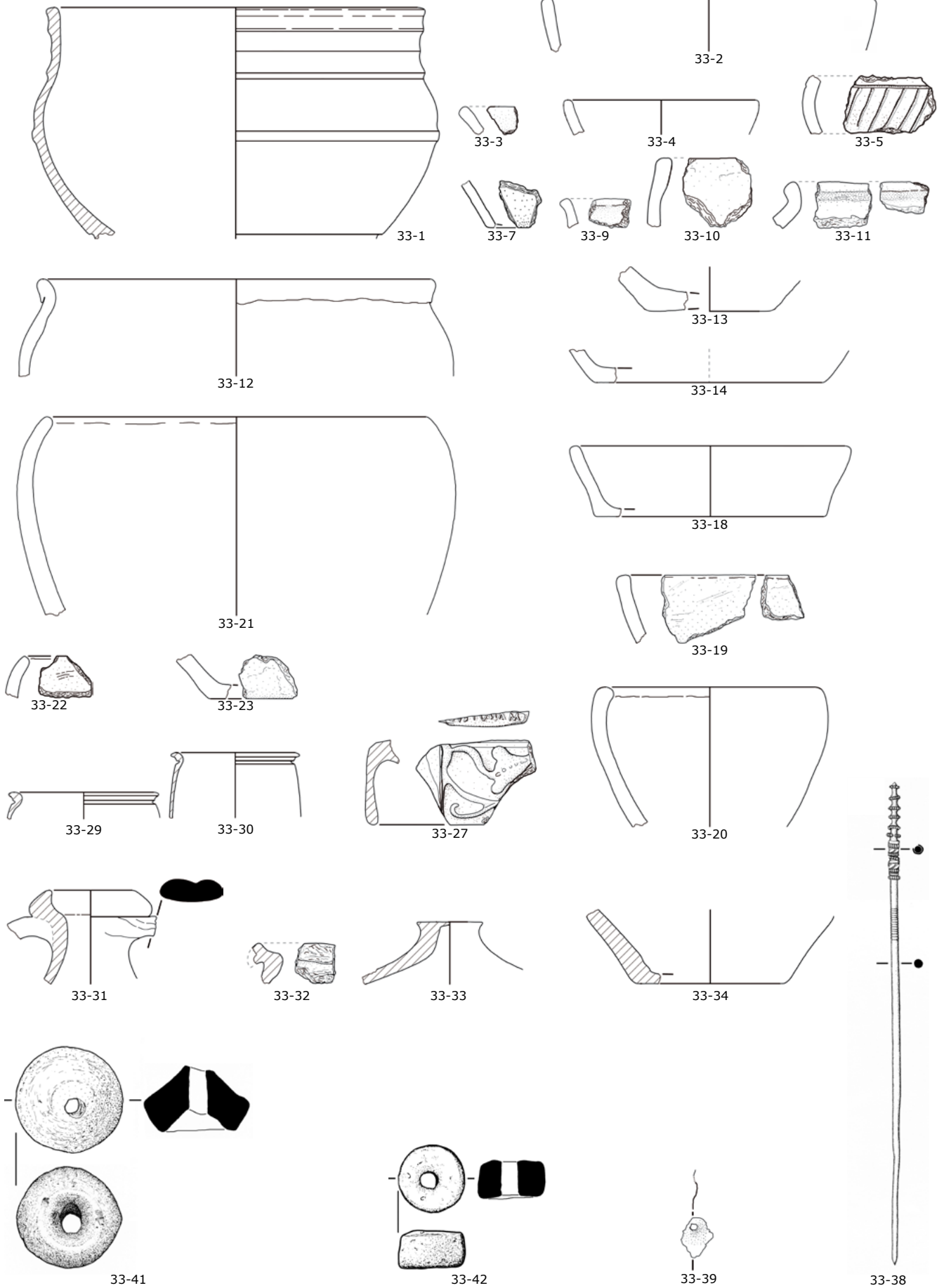

GÜG BK 34

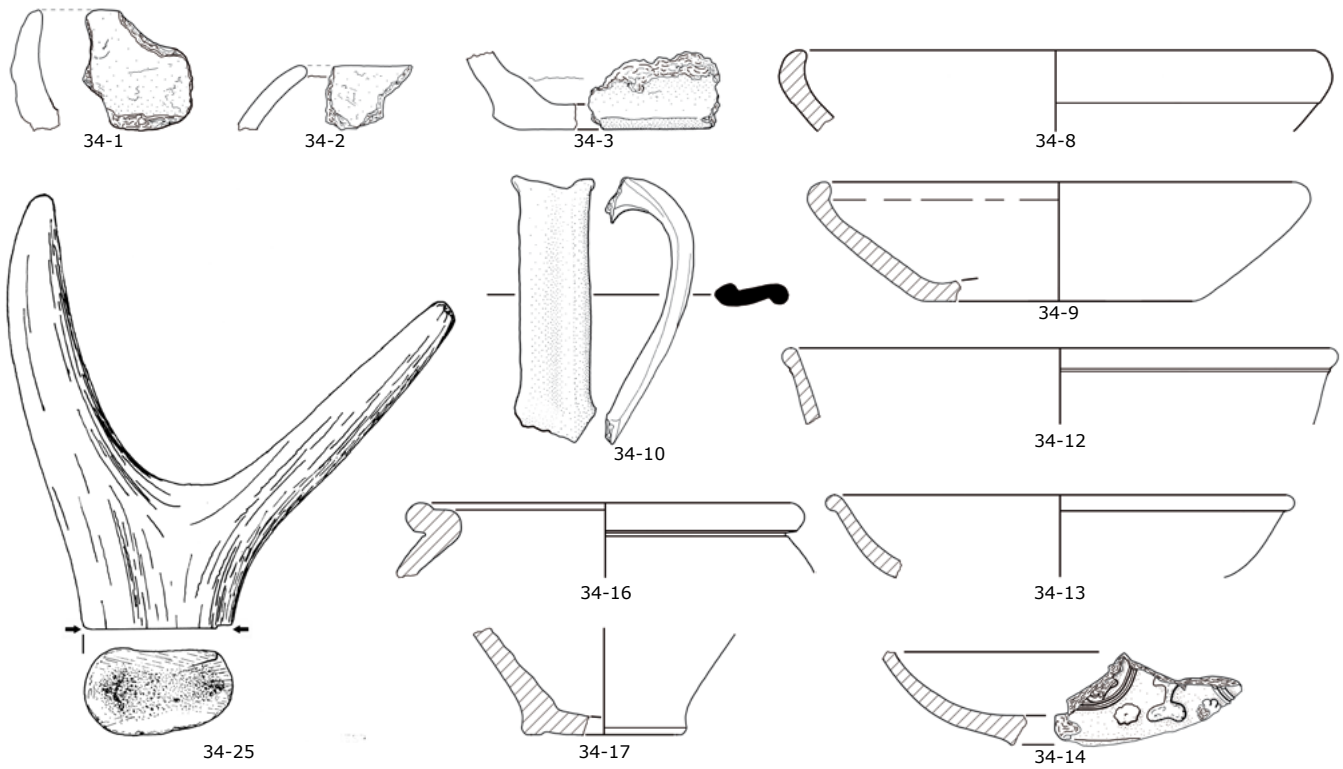

GÜG BK 36

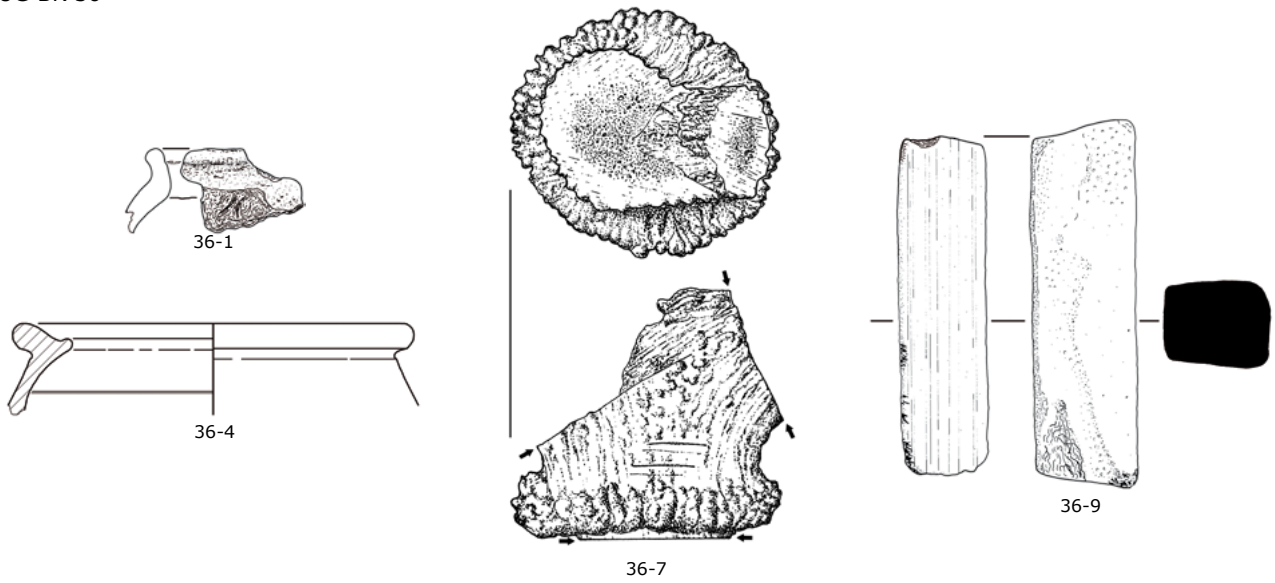

GÜG BK 37

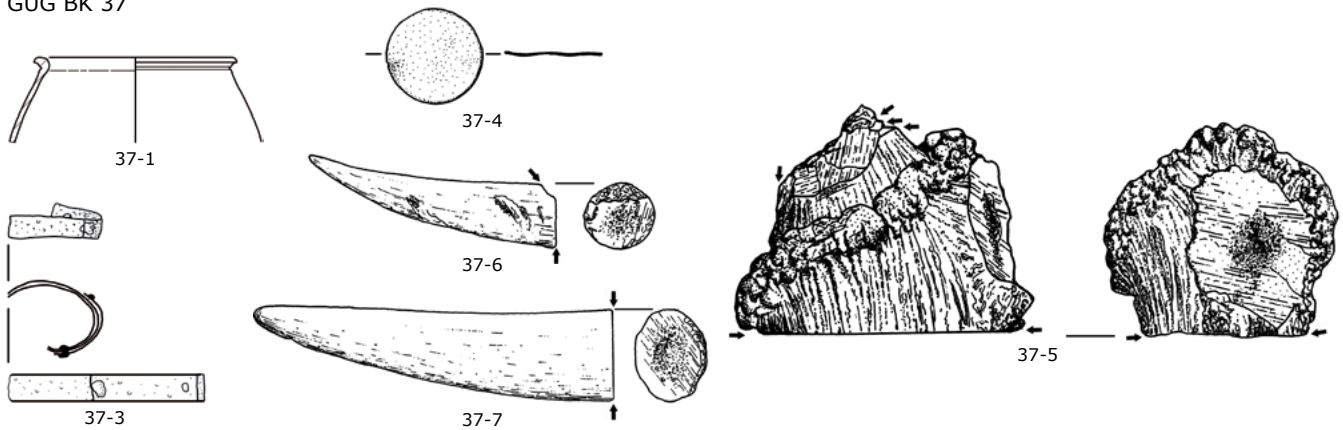

GÜG BK 38

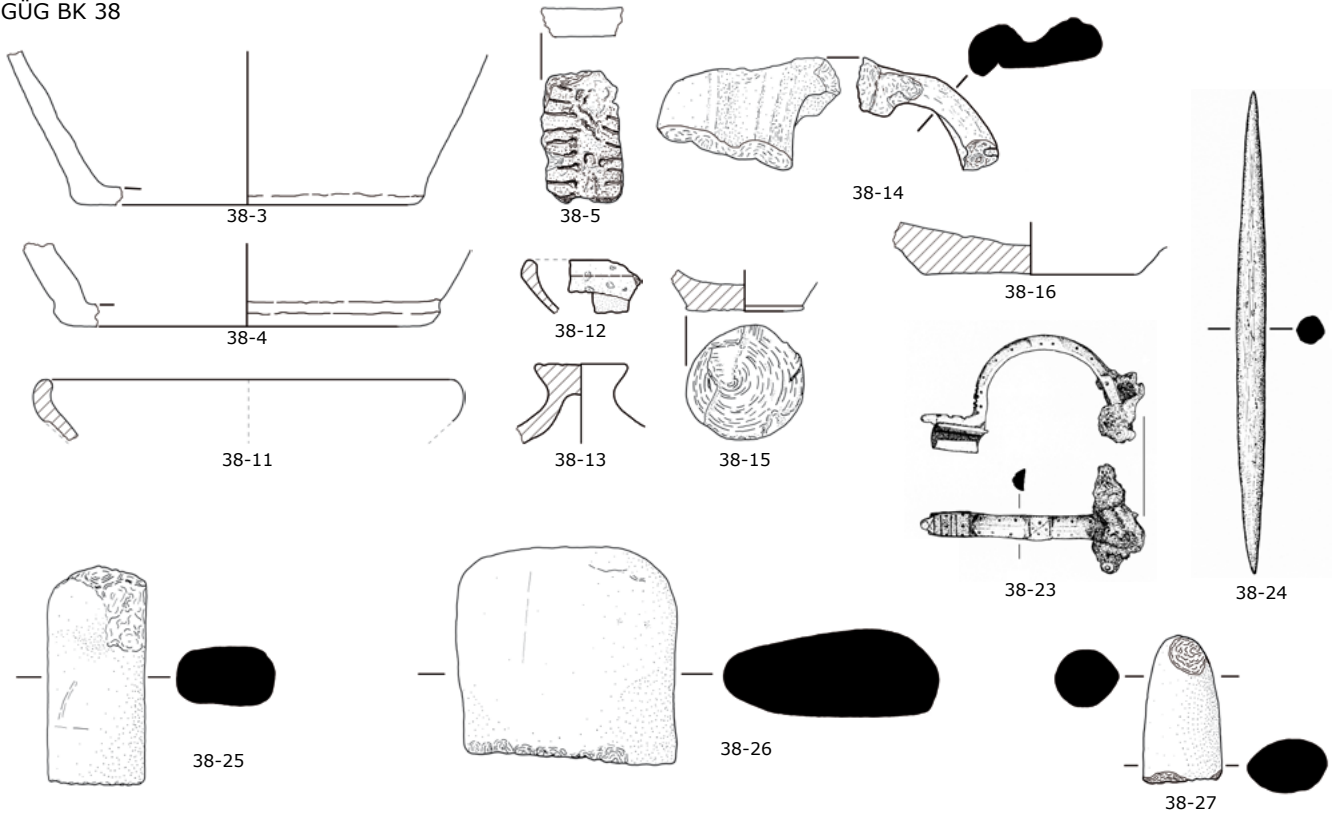

GÜG BK 39

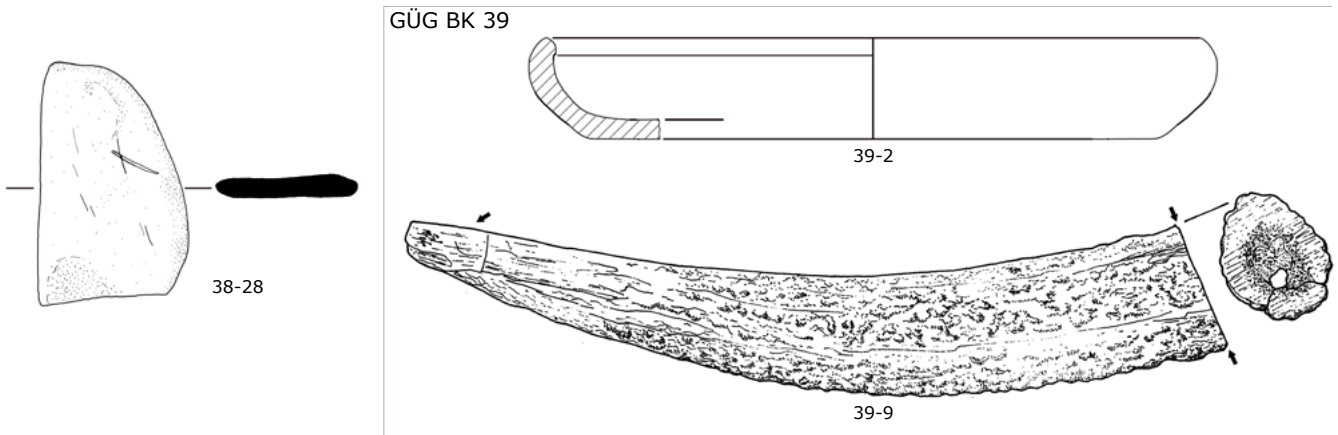

GÜG BK 40

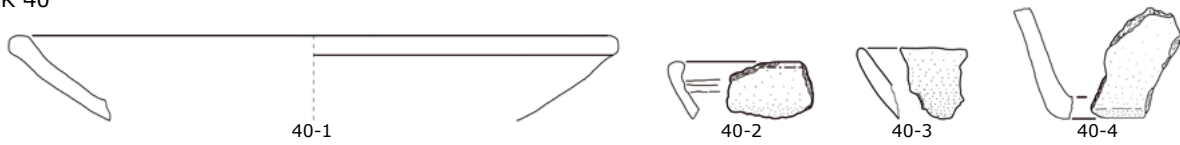

GÜG BK 42a

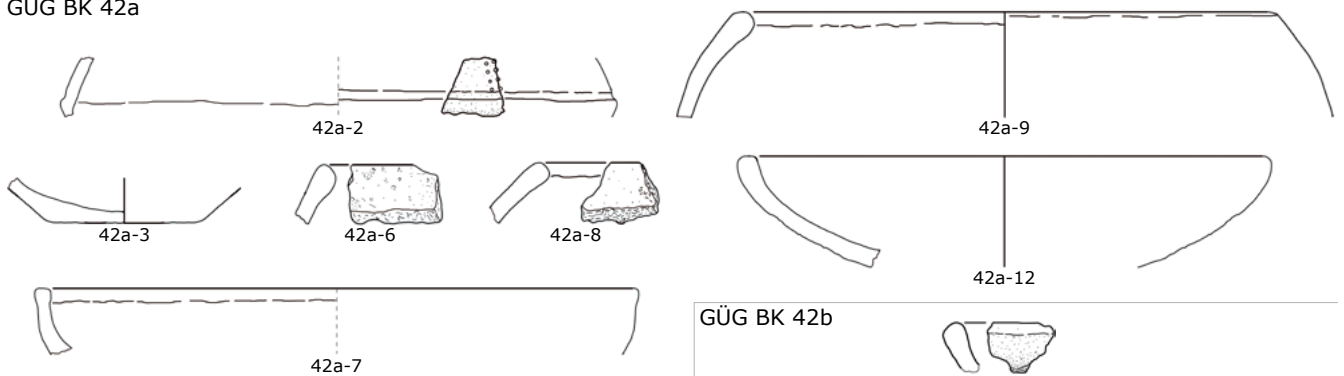

GÜG BK 42b



GÜG BK 43

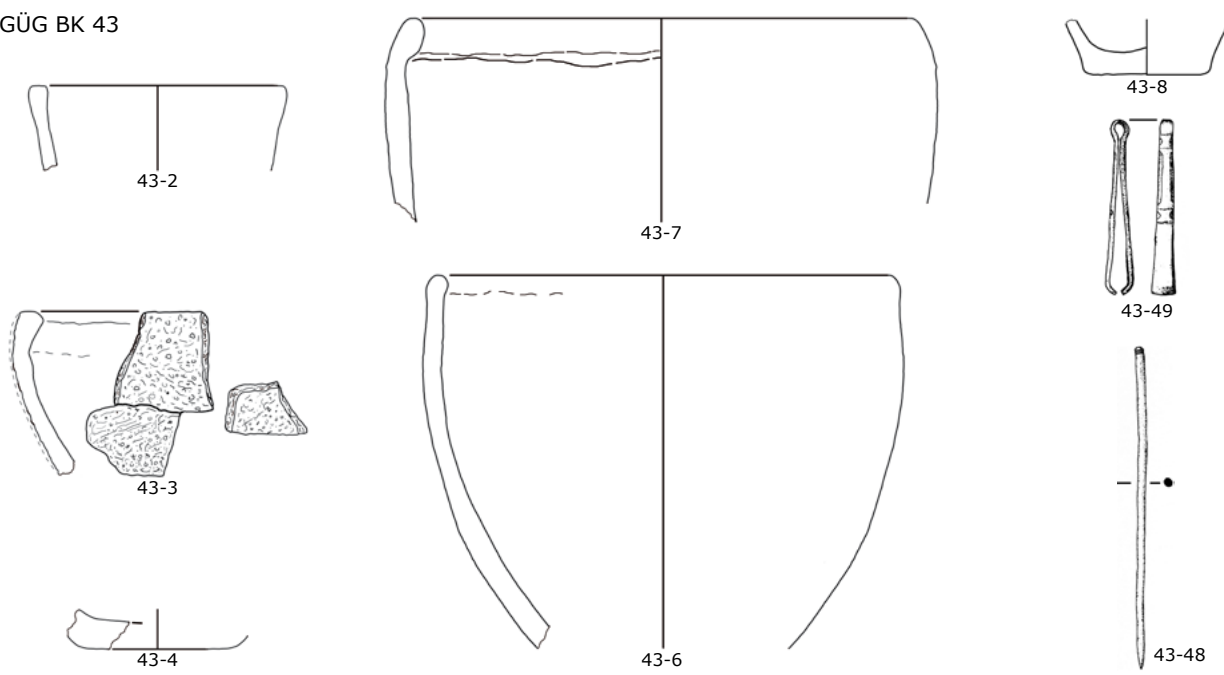

GÜG BK 44



GÜG BK 47

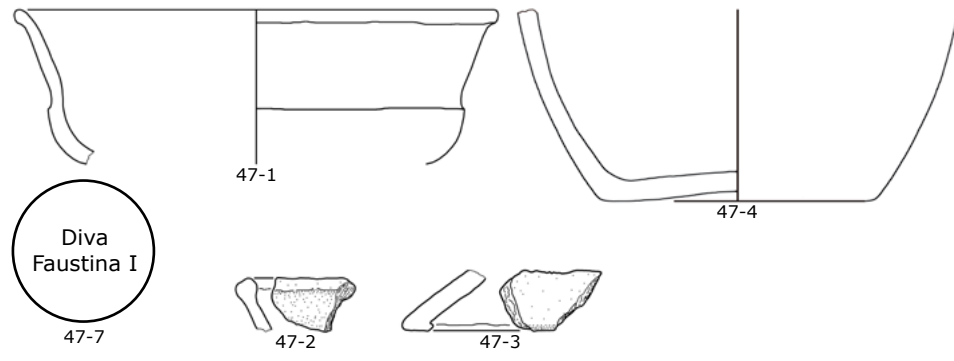

GÜG BK 48

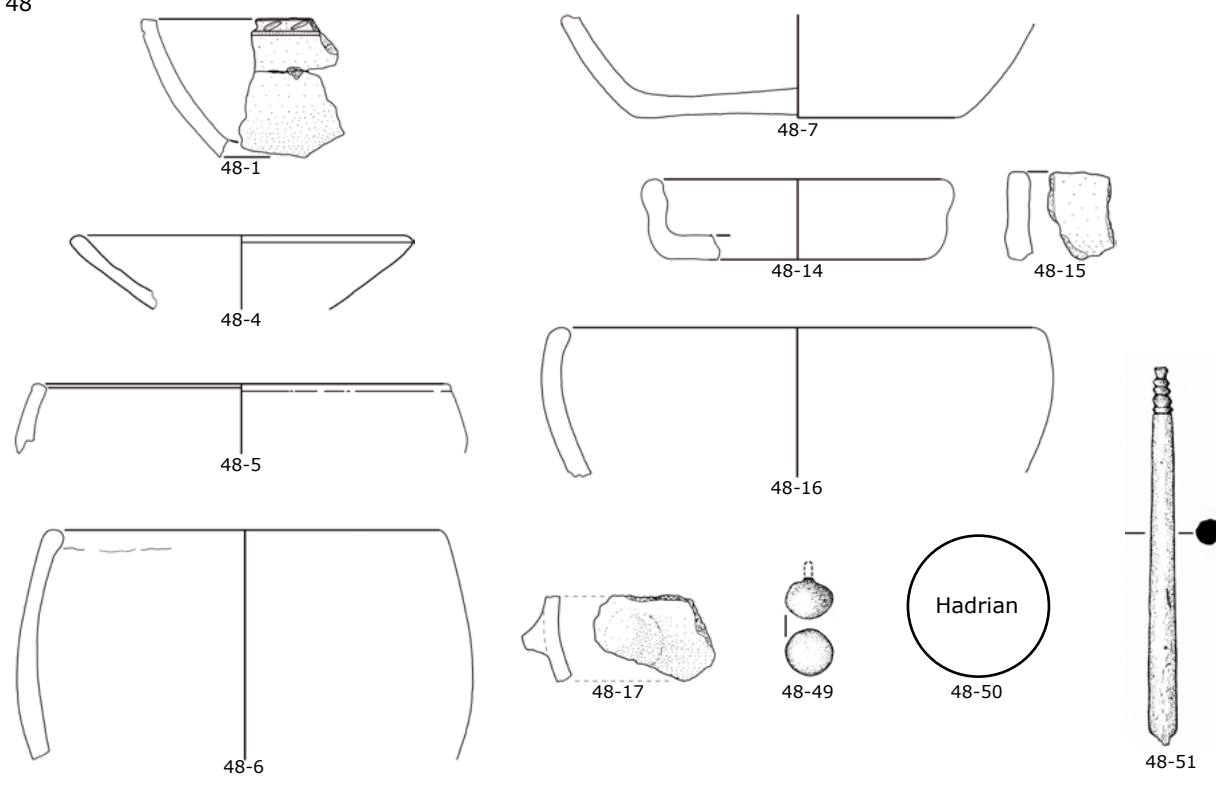

GÜG BK 49

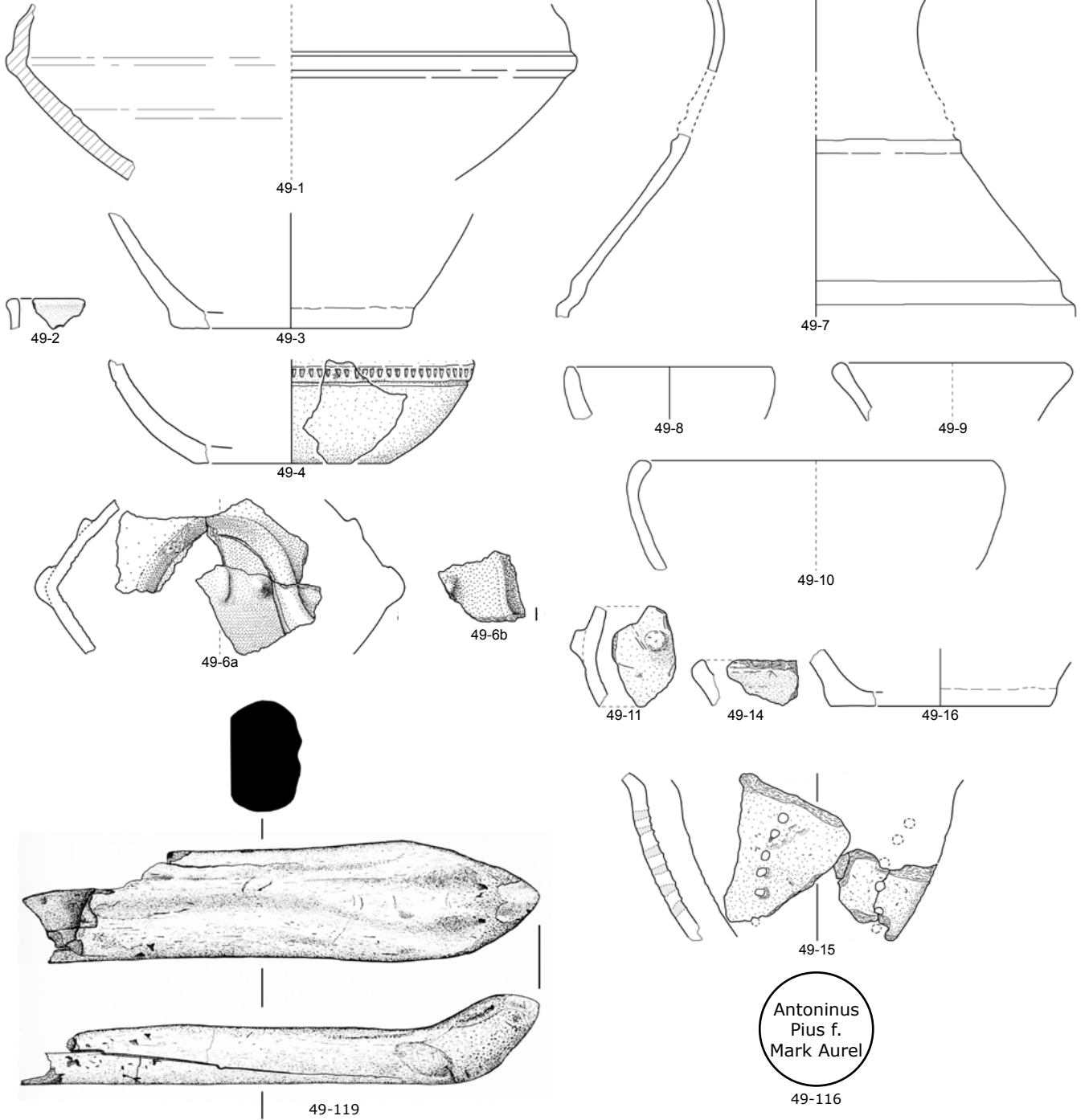

GÜG BK 50

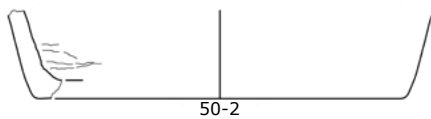

50-11

GÜG BK 51

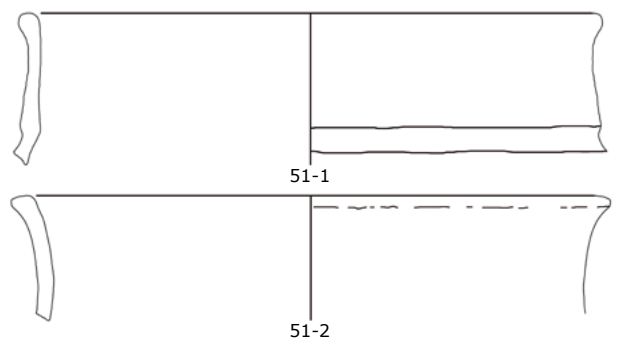

GÜG BK 51

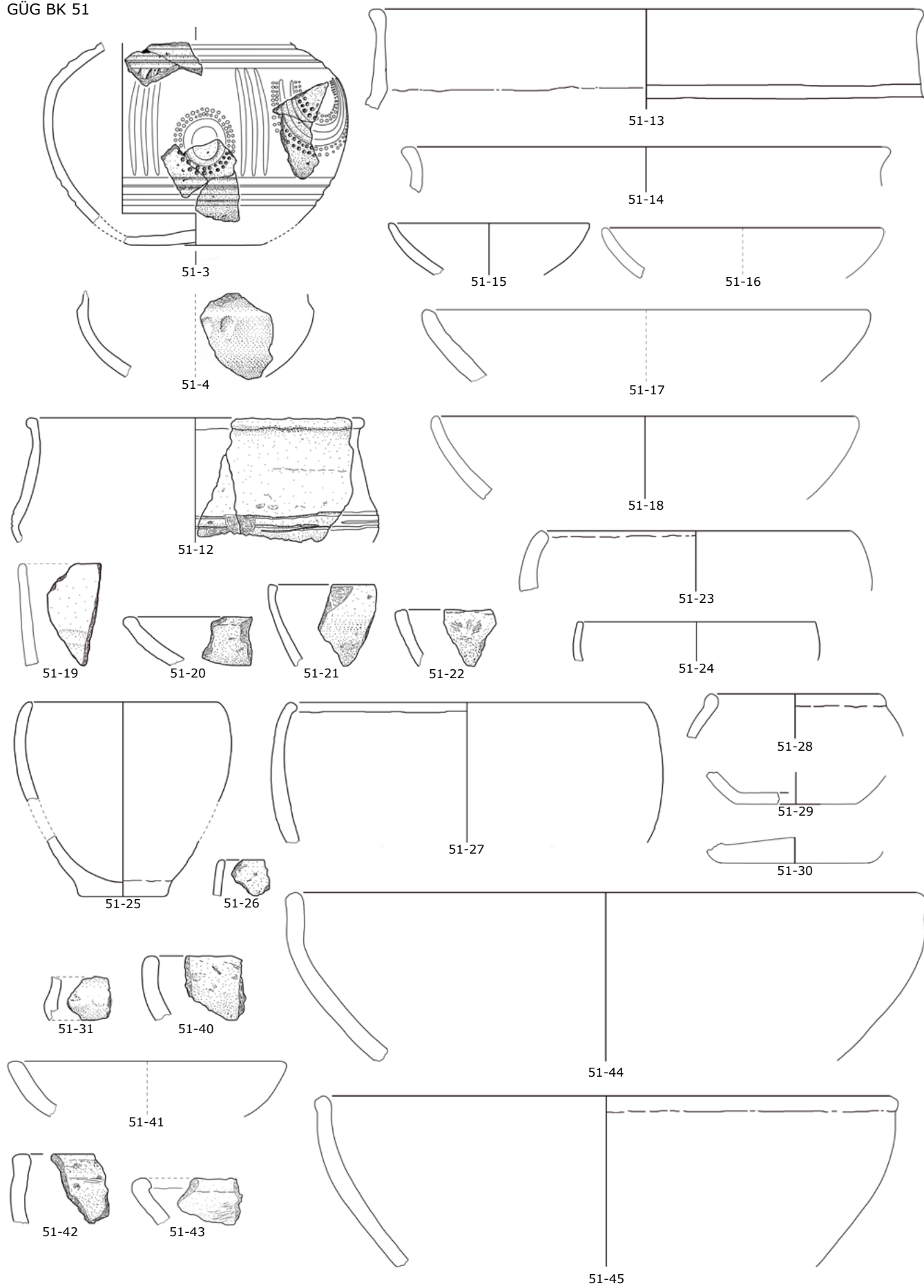

GÜG BK 51

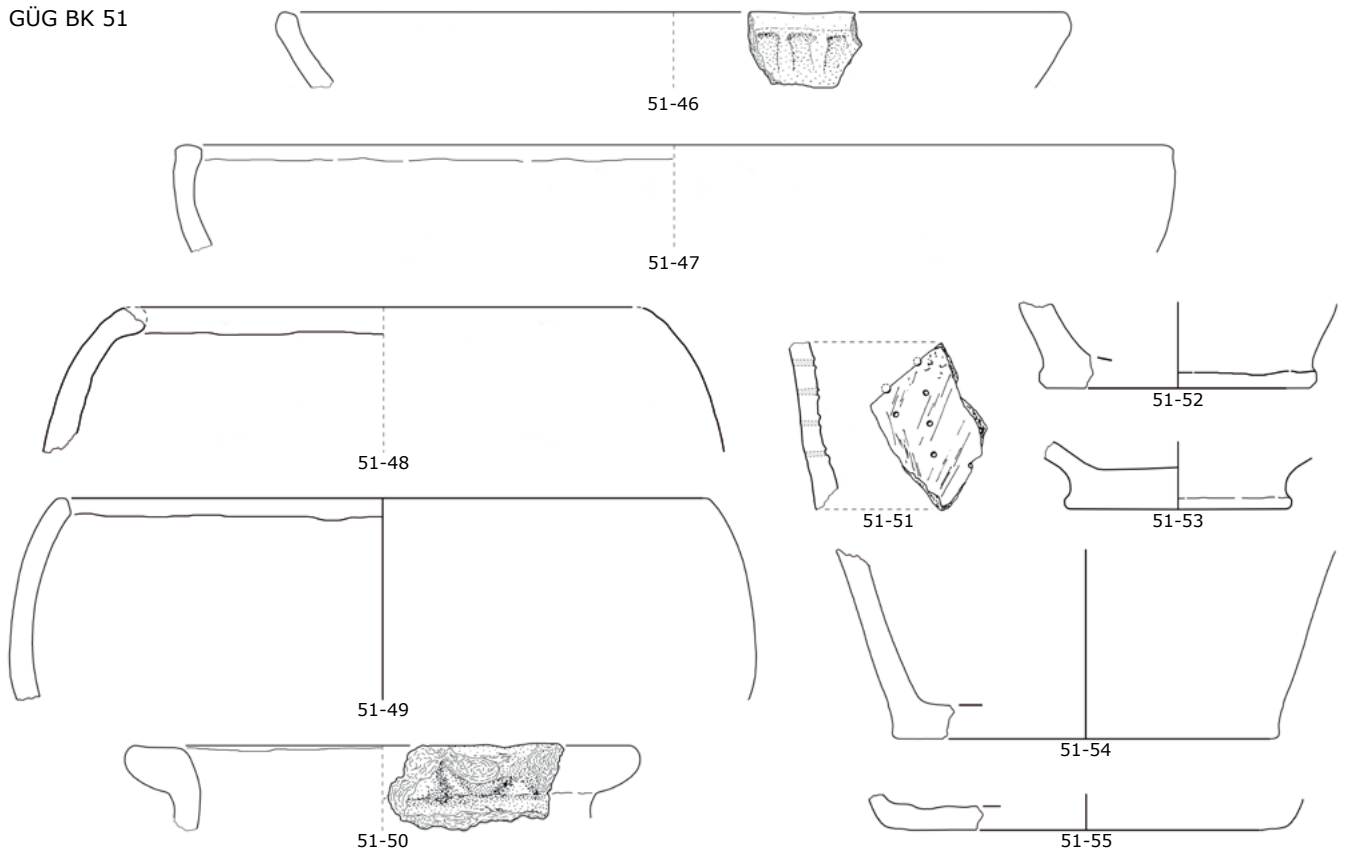

GÜG BK 51 - Depot

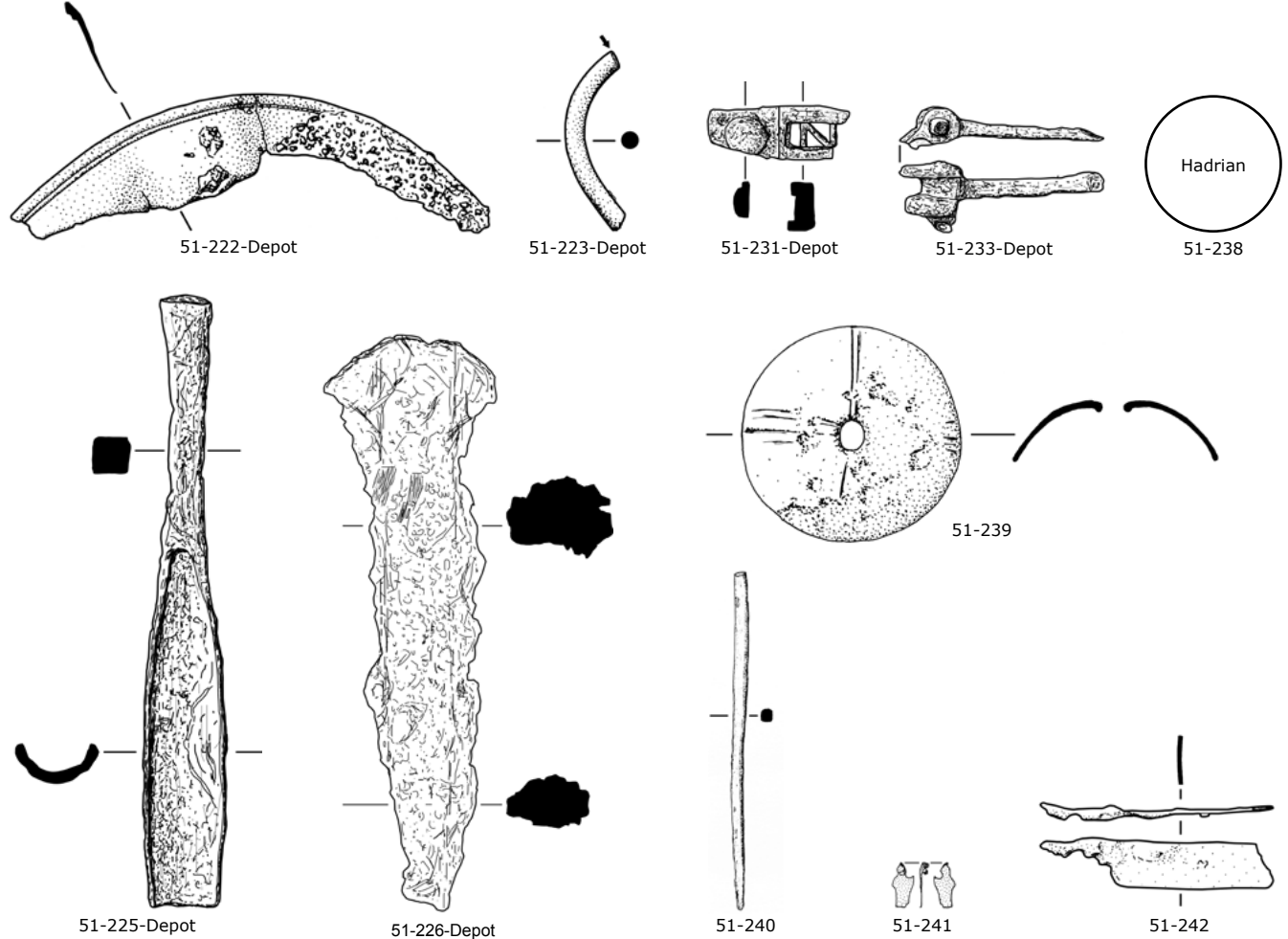

GÜG BK 51

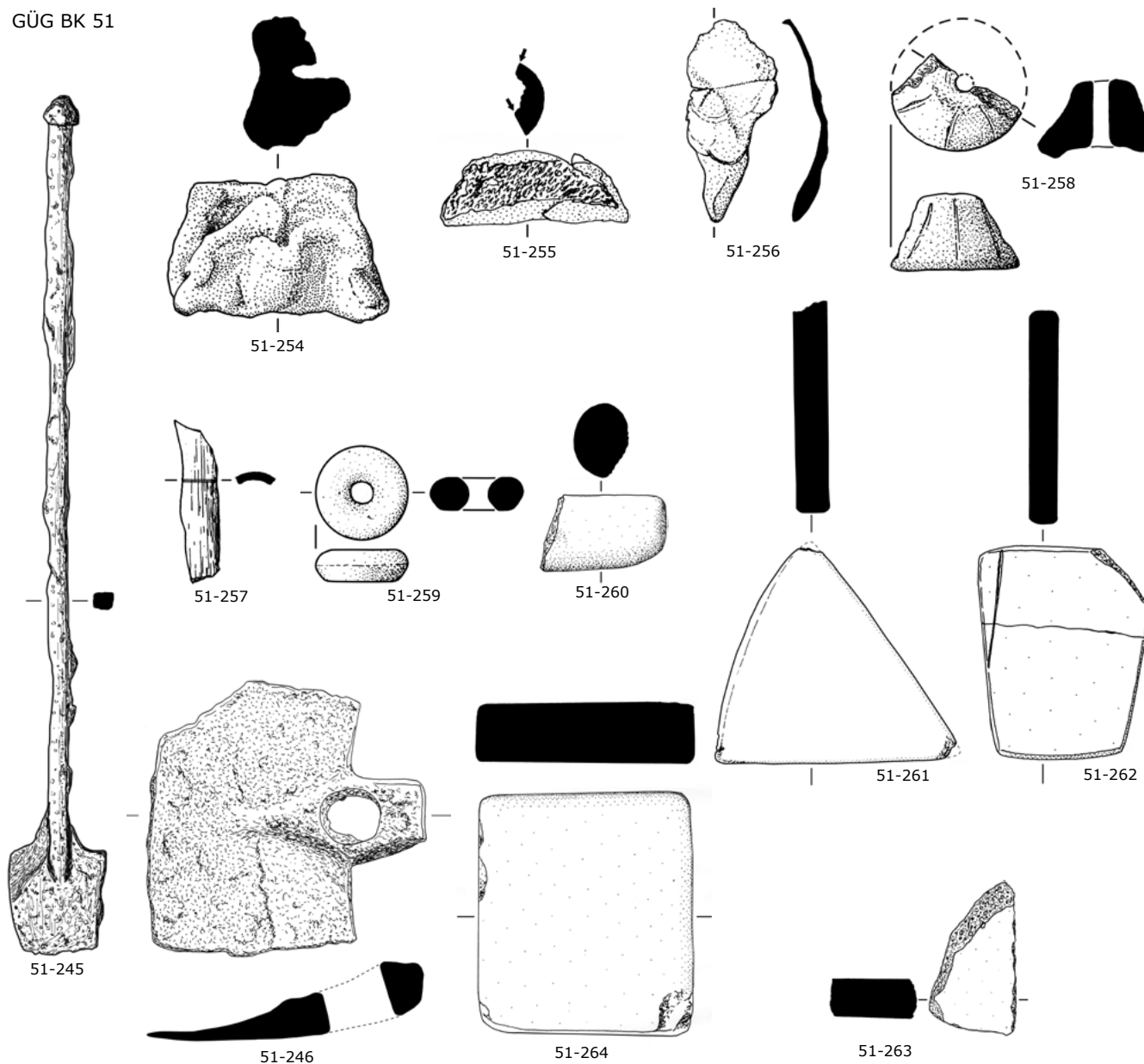

GÜG BK 56

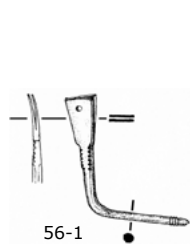

GÜG BK 57



GÜG BK 58

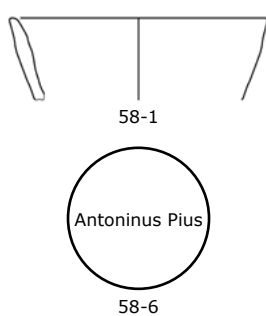

GÜG BK 59

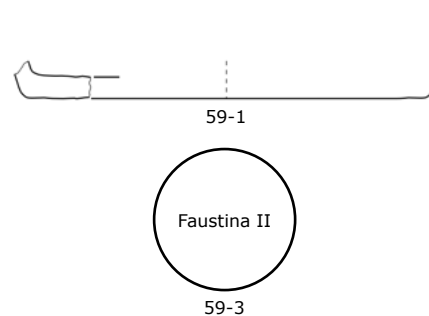

GÜG BK 60

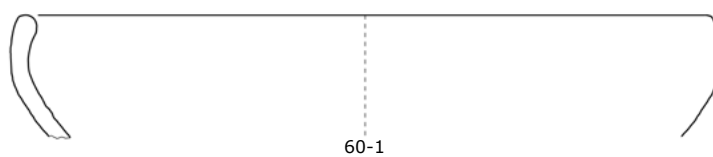

GÜG BK 63

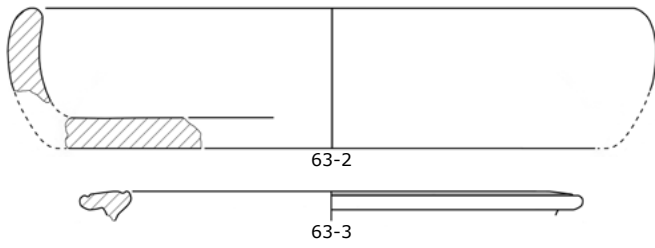

GÜG BK 64a

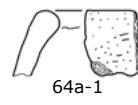

GÜG BK 64c

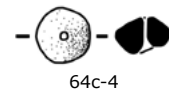

GÜG BK 64d



GÜG BK 64e

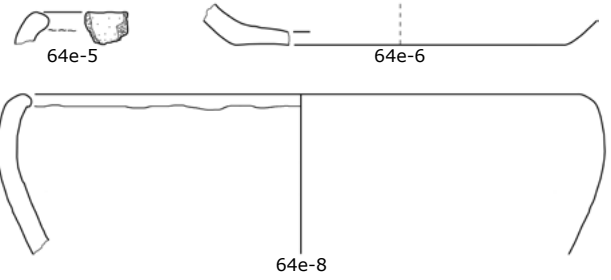
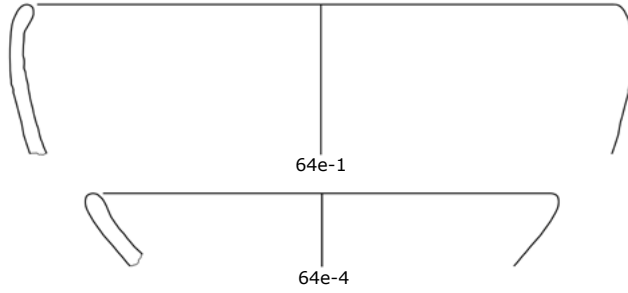

GÜG BK 64g

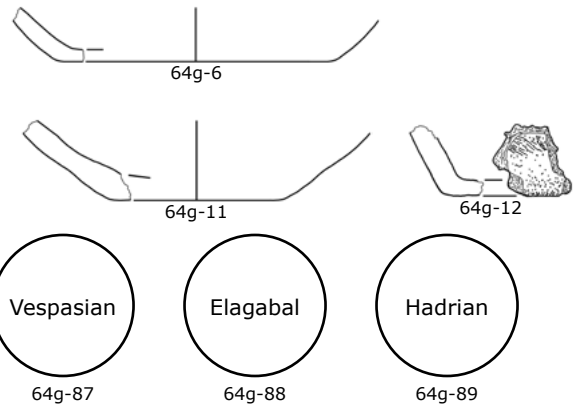
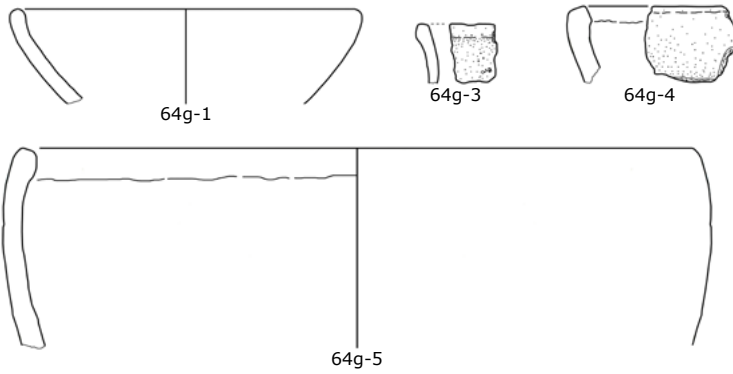

GÜG BK 64h

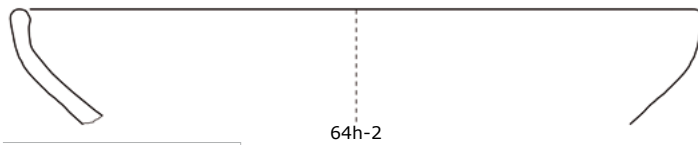

GÜG BK 66

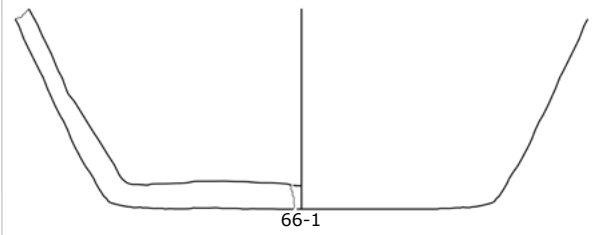

GÜG BK 67

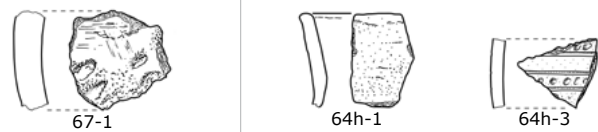

GÜG BK 68

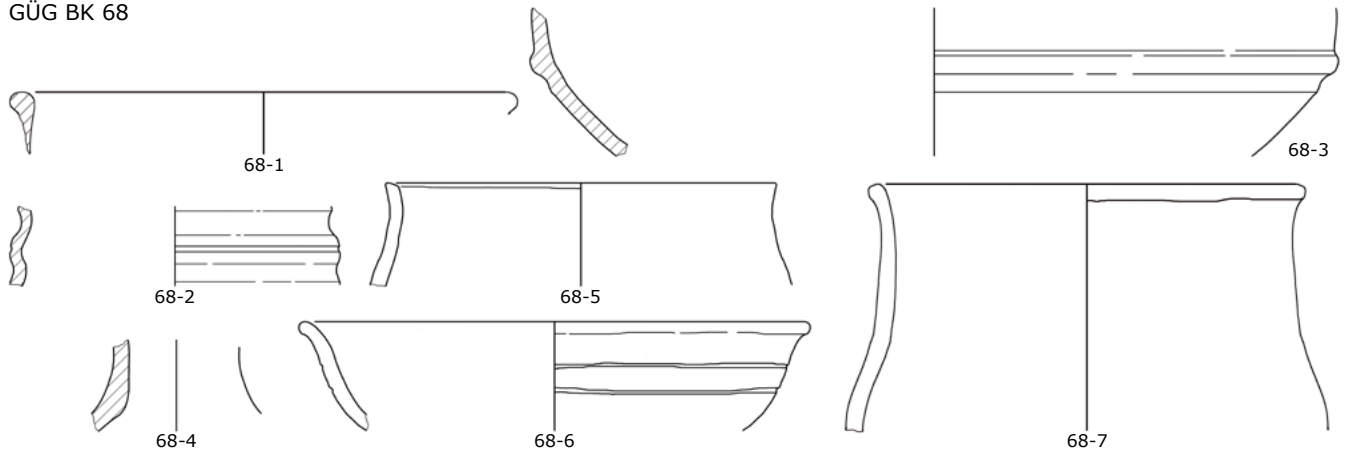

GÜG BK 68

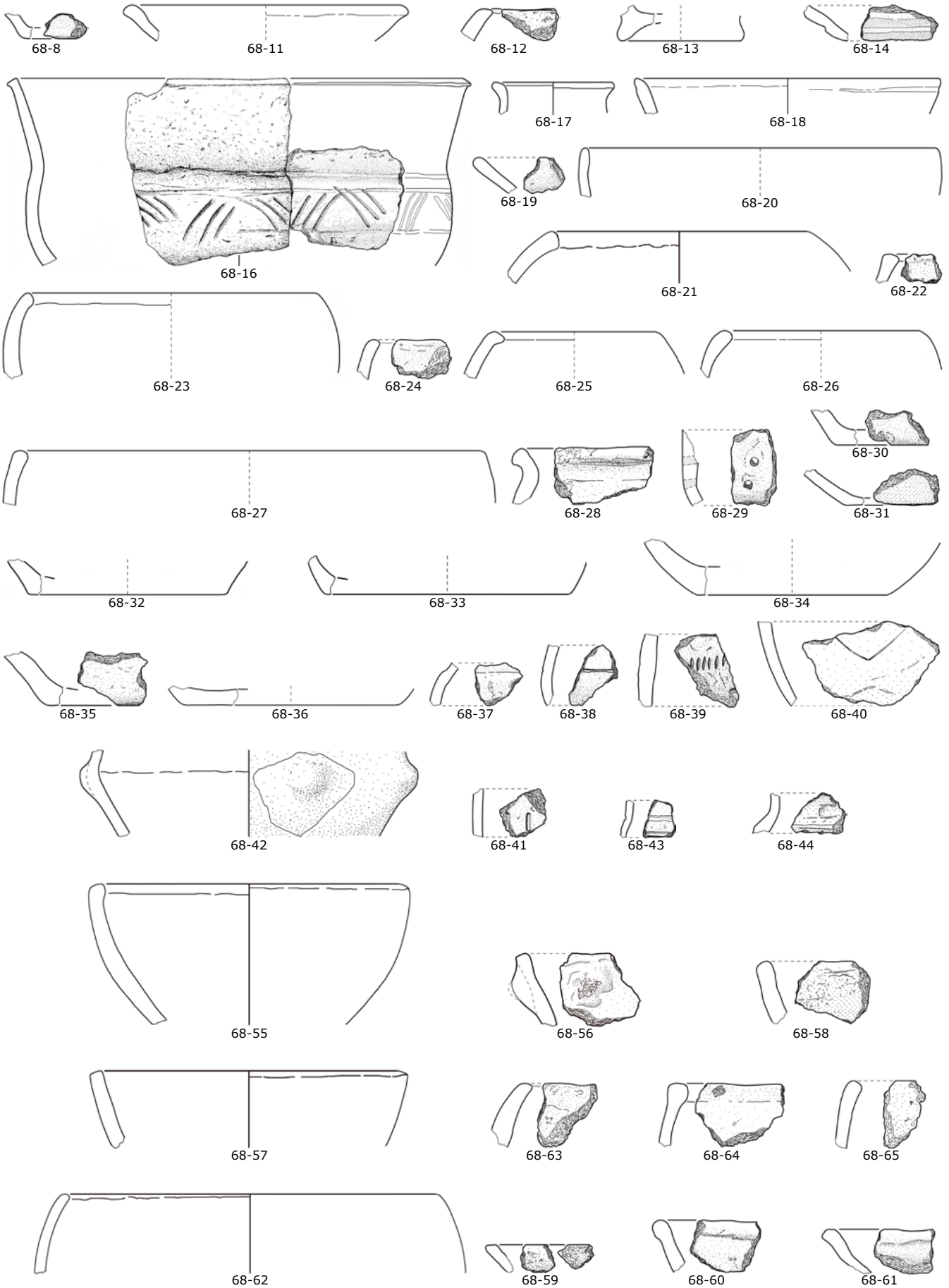

GÜG BK 68

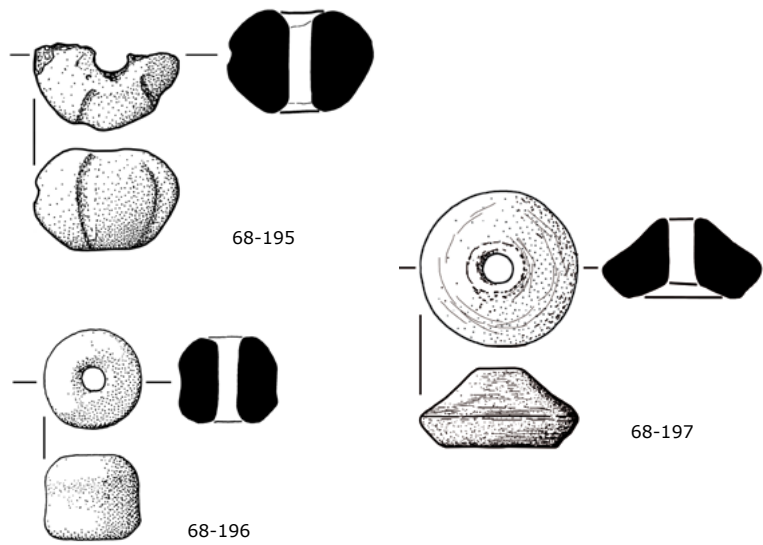
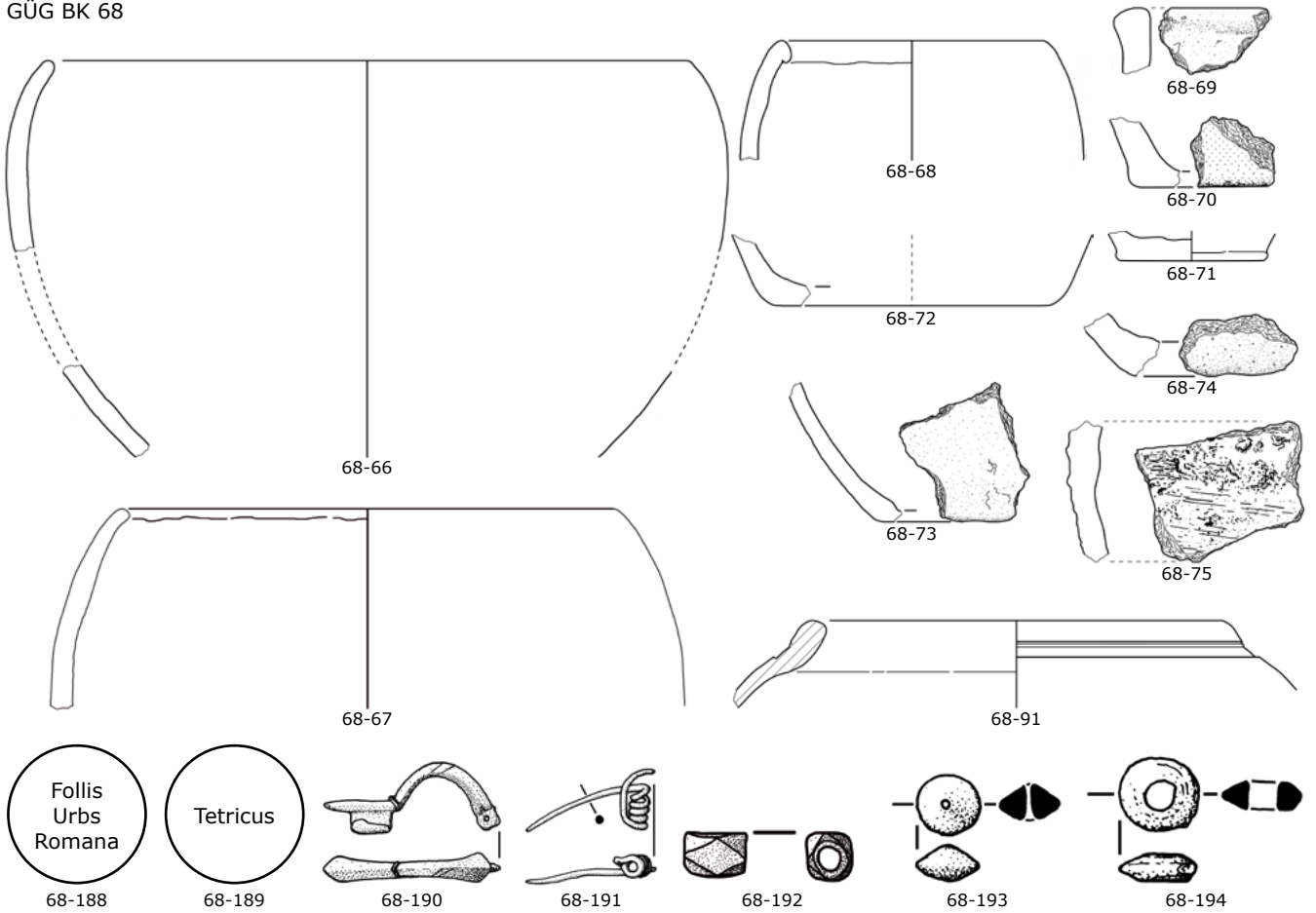

GUN

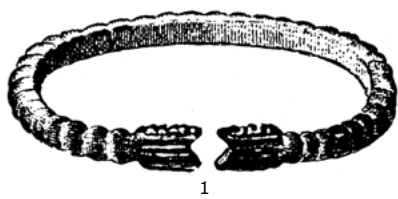

HEB

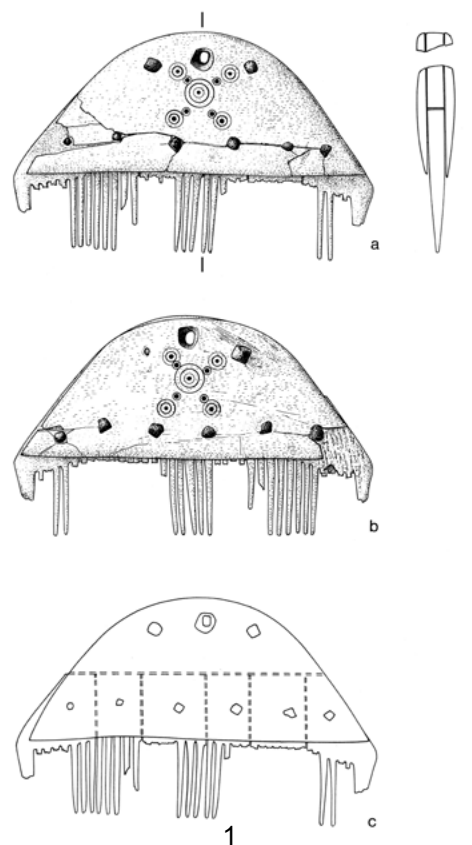

IHG

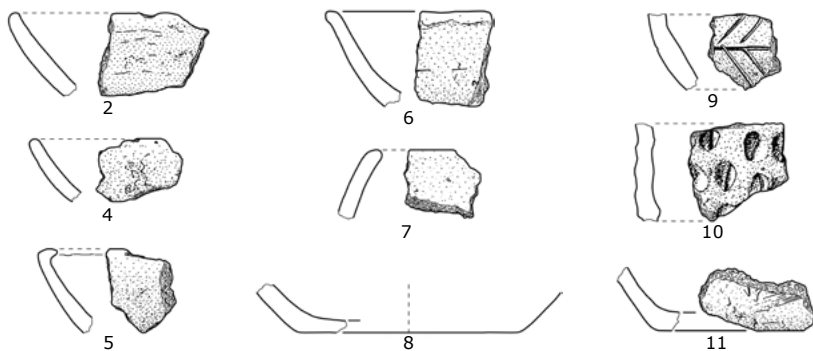
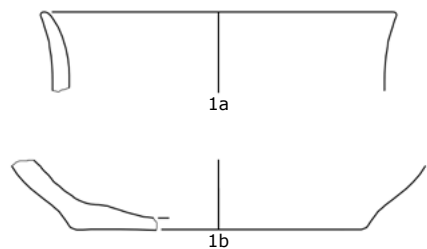

KIH

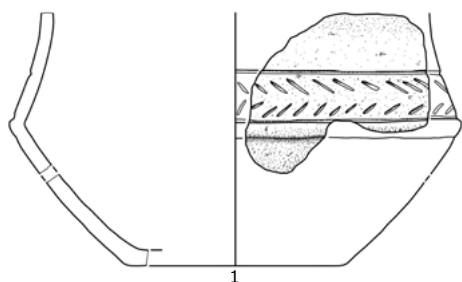

KNI

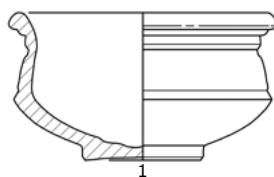

KÜR

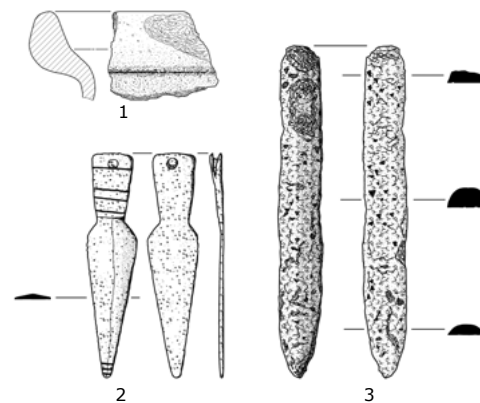

LAU-C

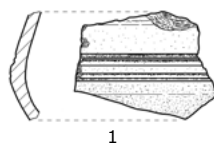

LAU-A

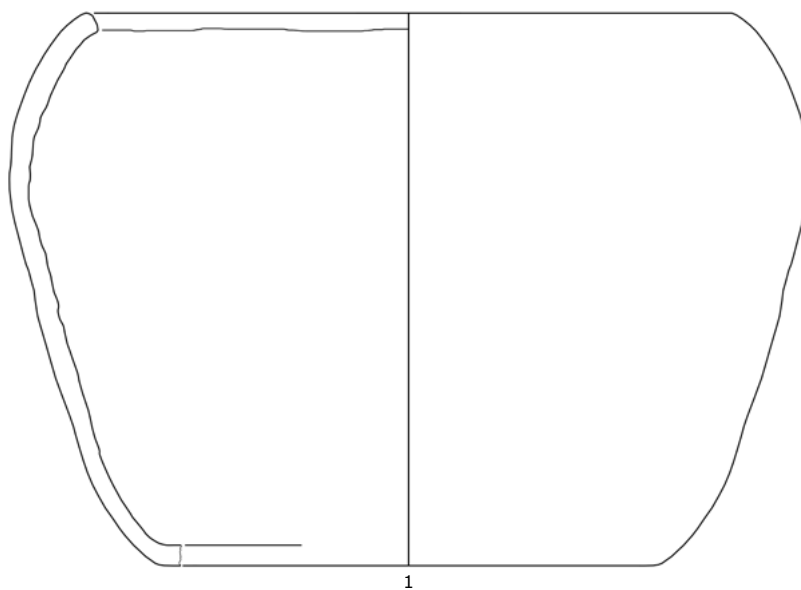

LAU-D BK 1

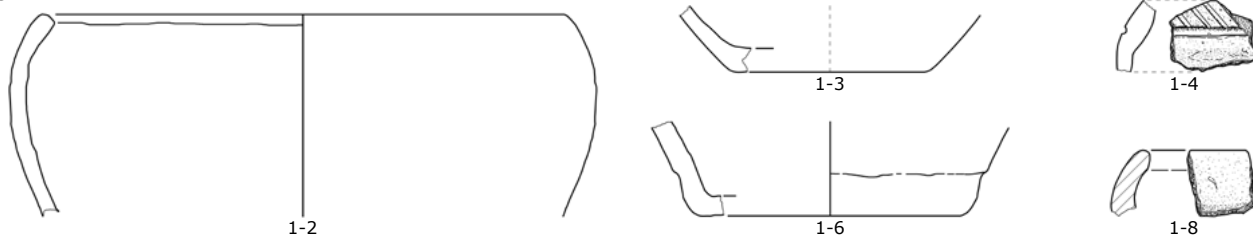

LAU-D BK 2

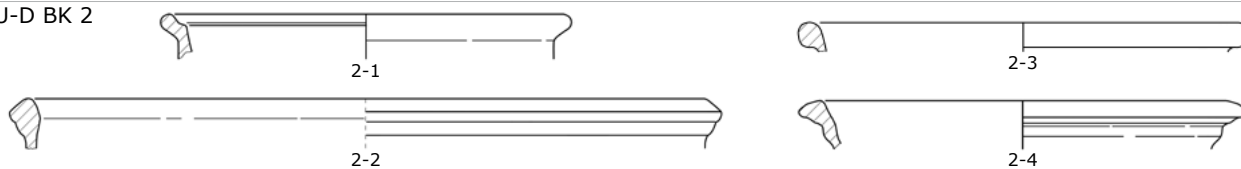

LAU-D BK 2

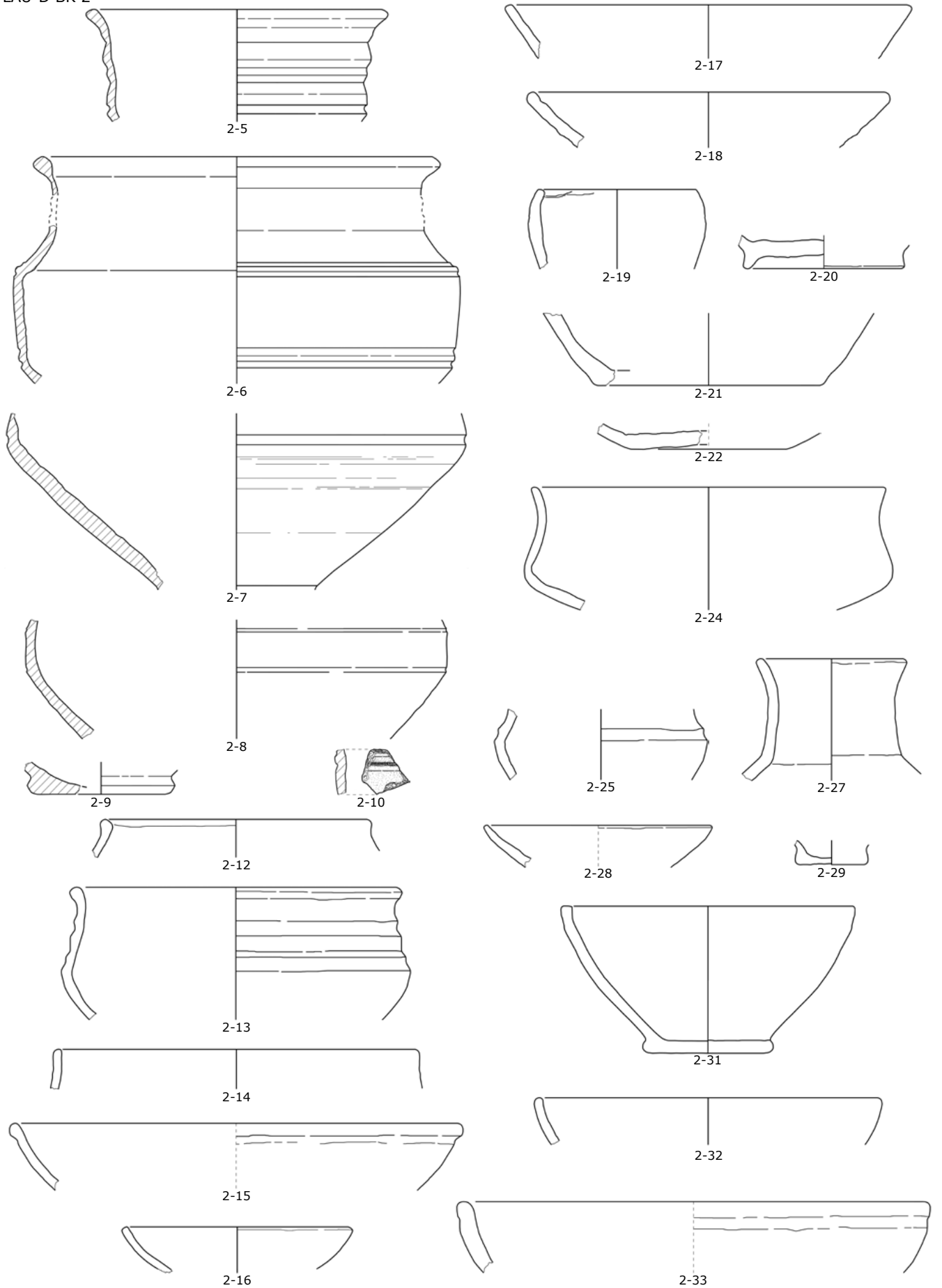

LAU-D BK 2

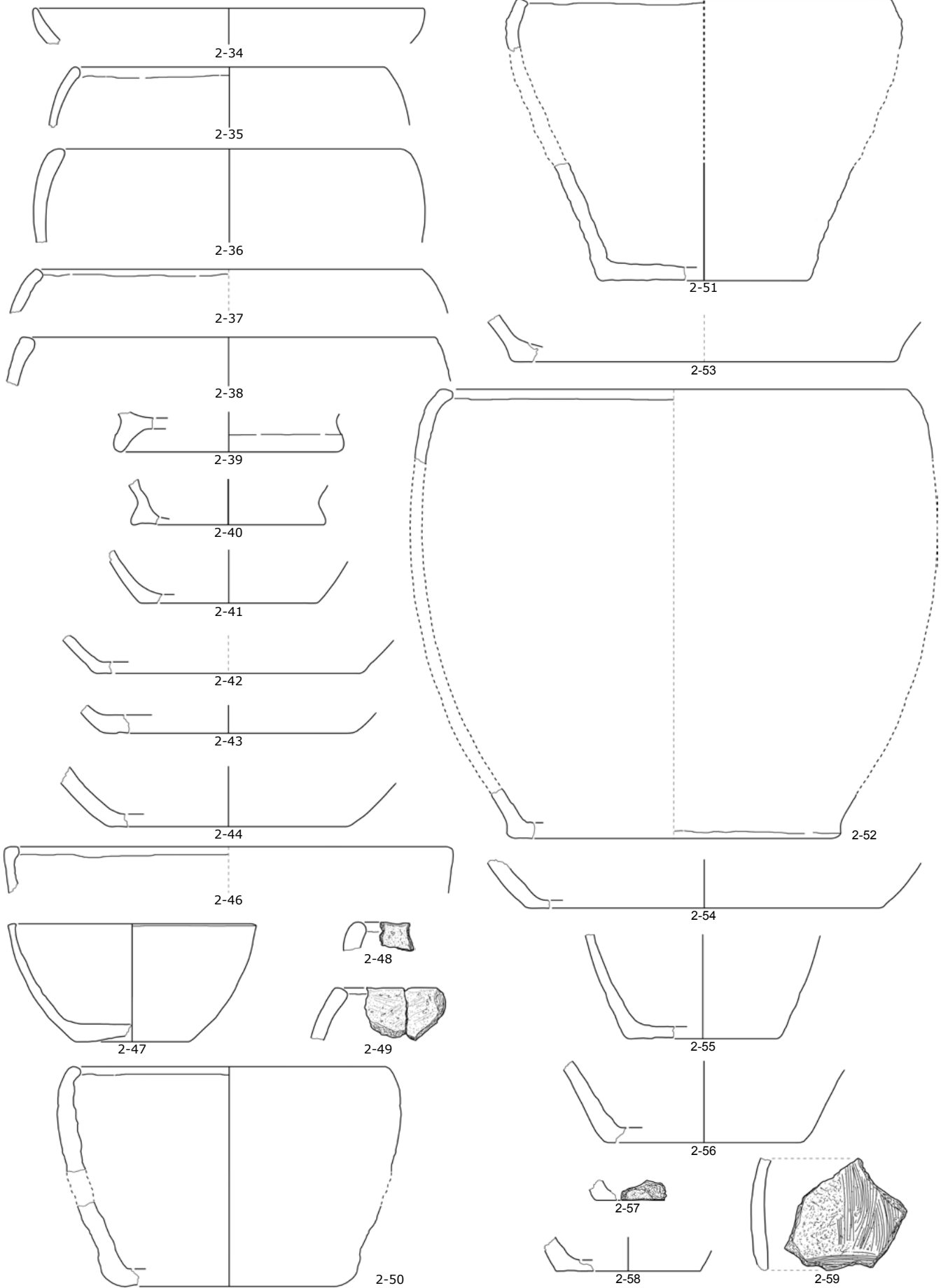

LAU-D BK 2

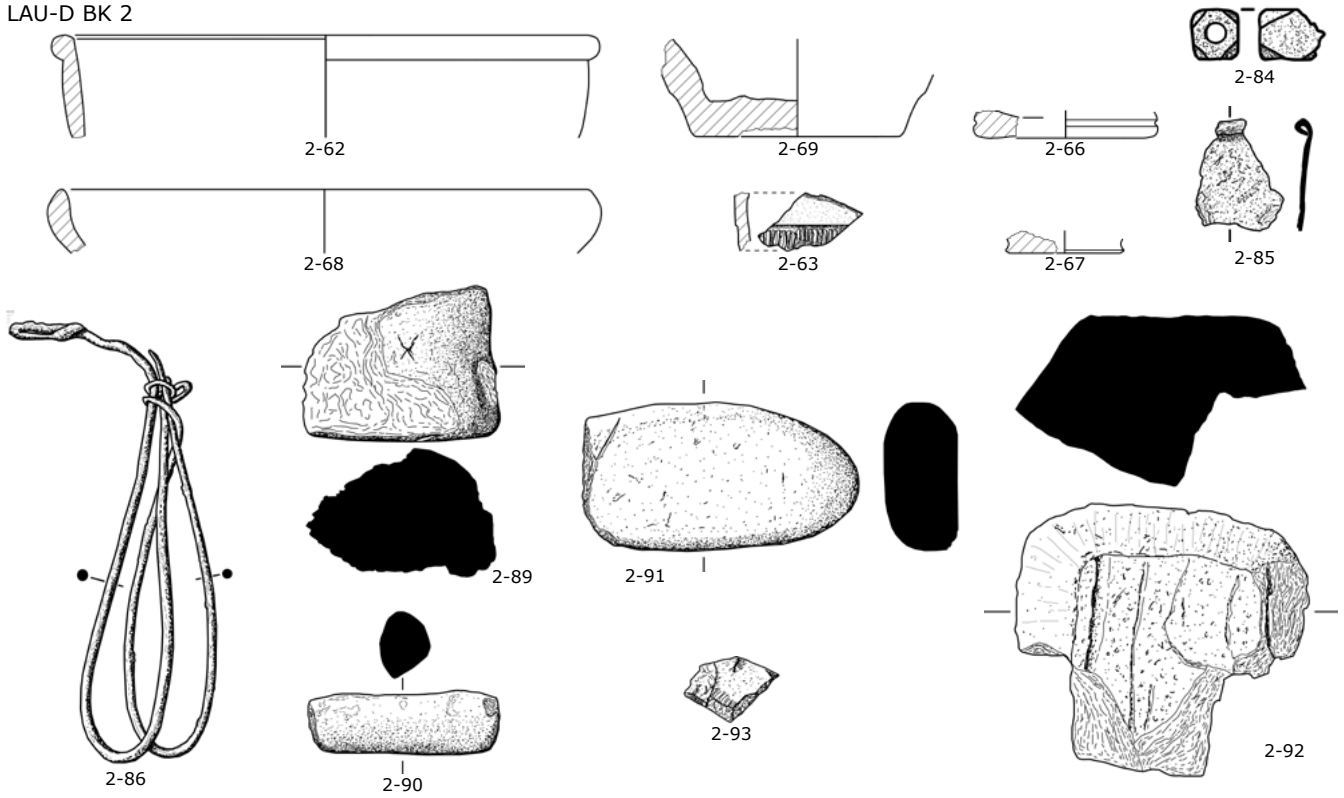

LAU-D BK 3

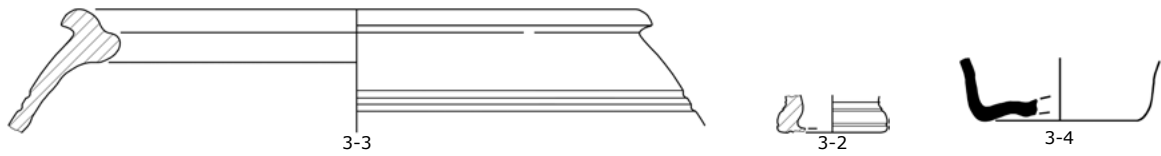

LAU-D BK 4

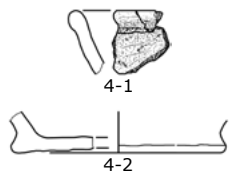

LAU-D BK 5

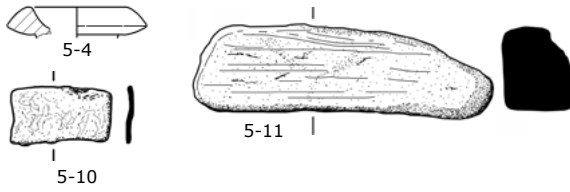

LAU-D BK 7

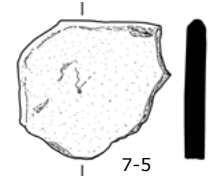

LAU-D BK 6

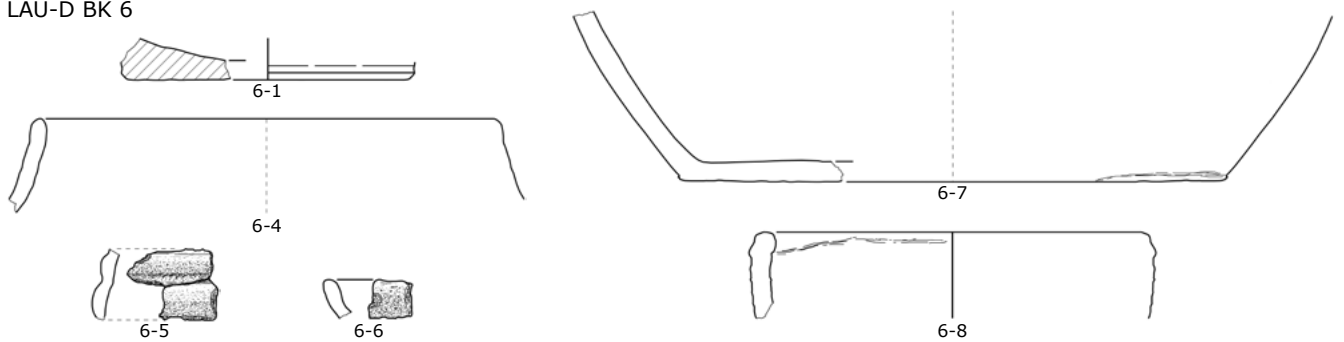

LAU-D BK 8

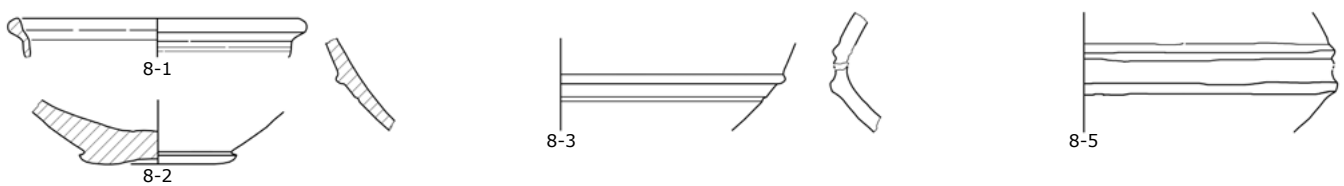

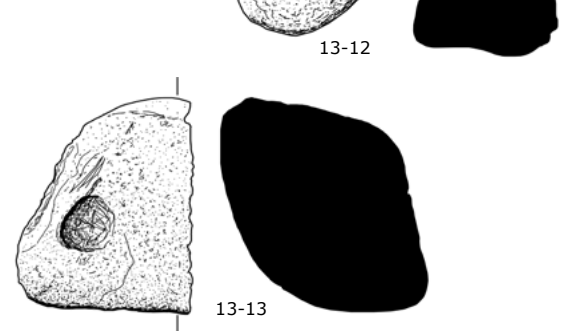
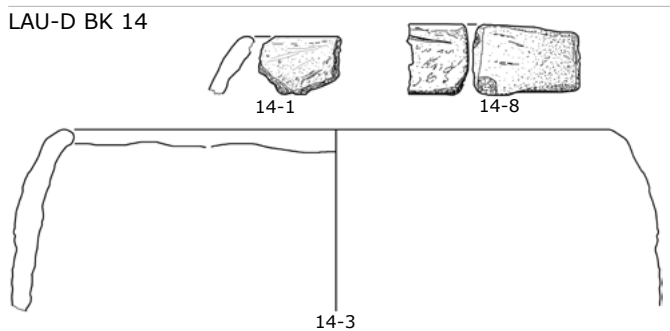
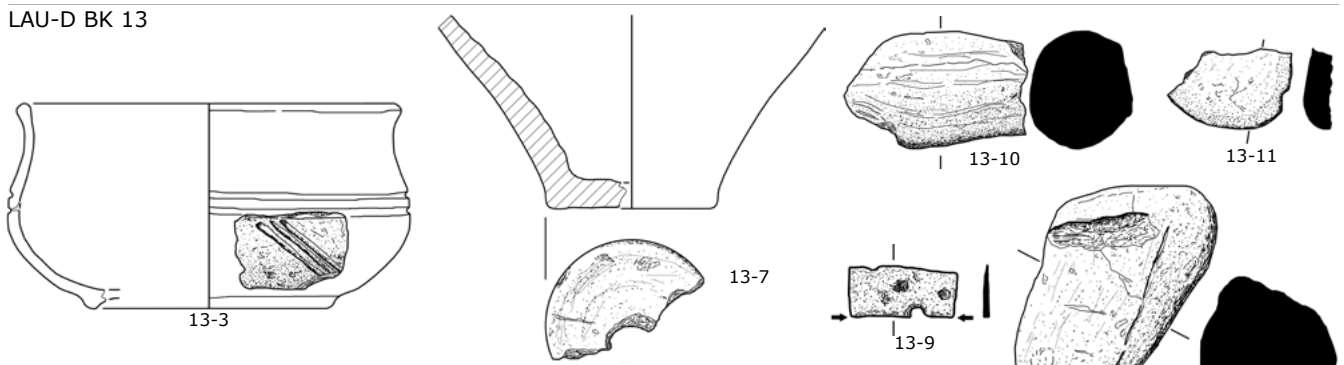
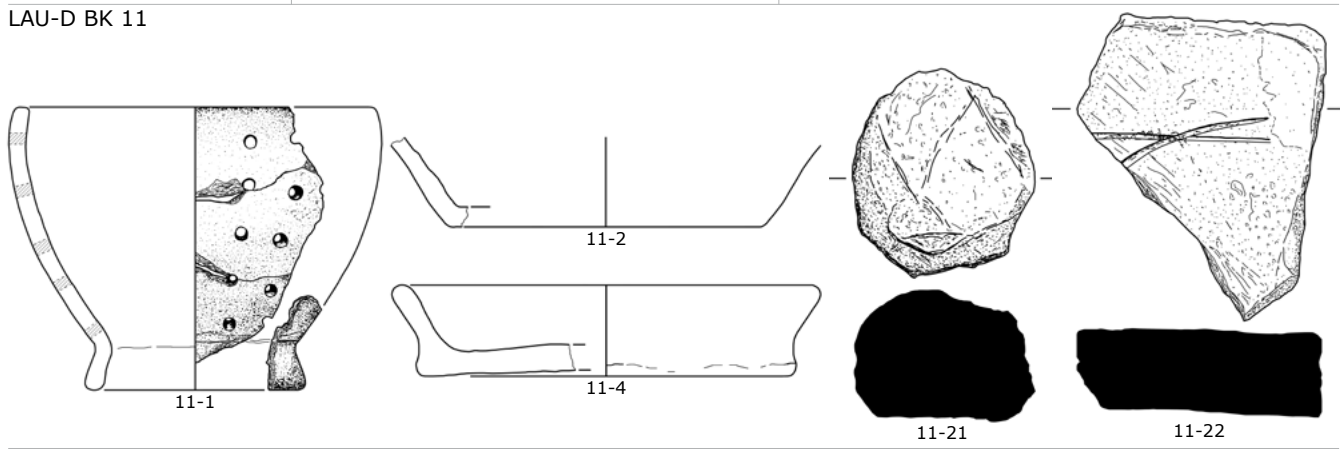
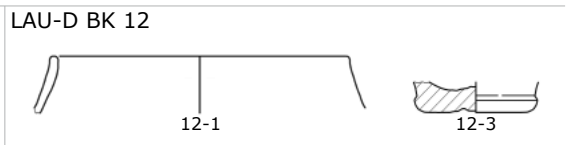
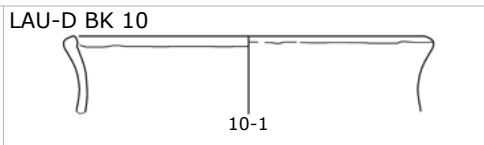
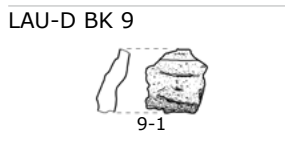
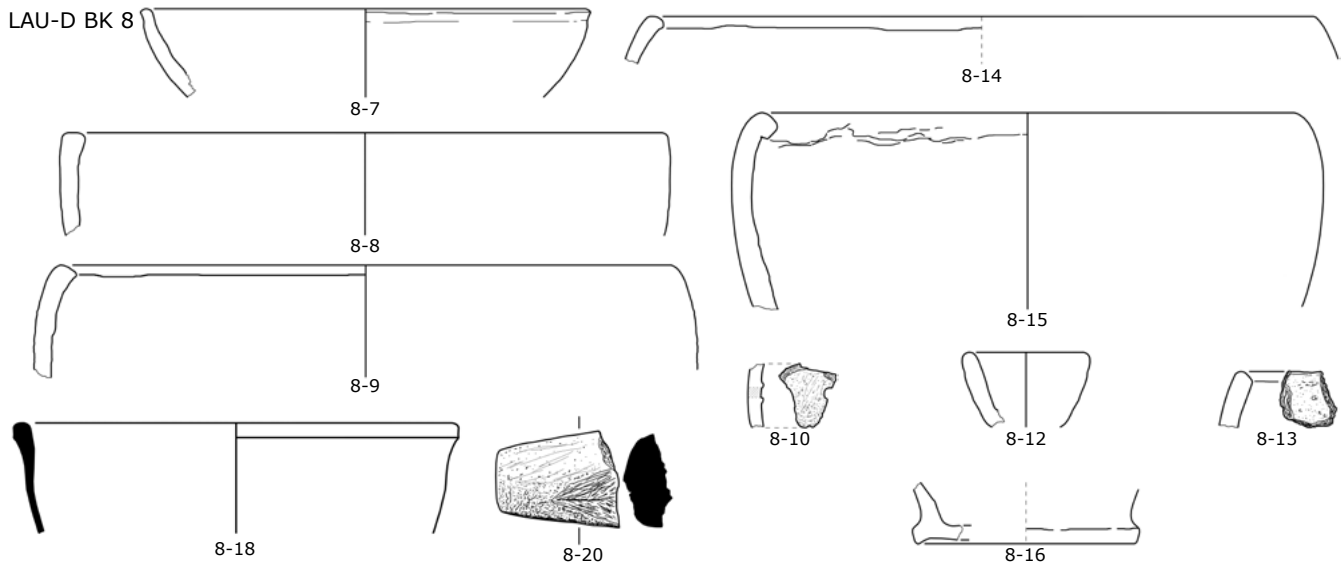

LAU-D BK 16

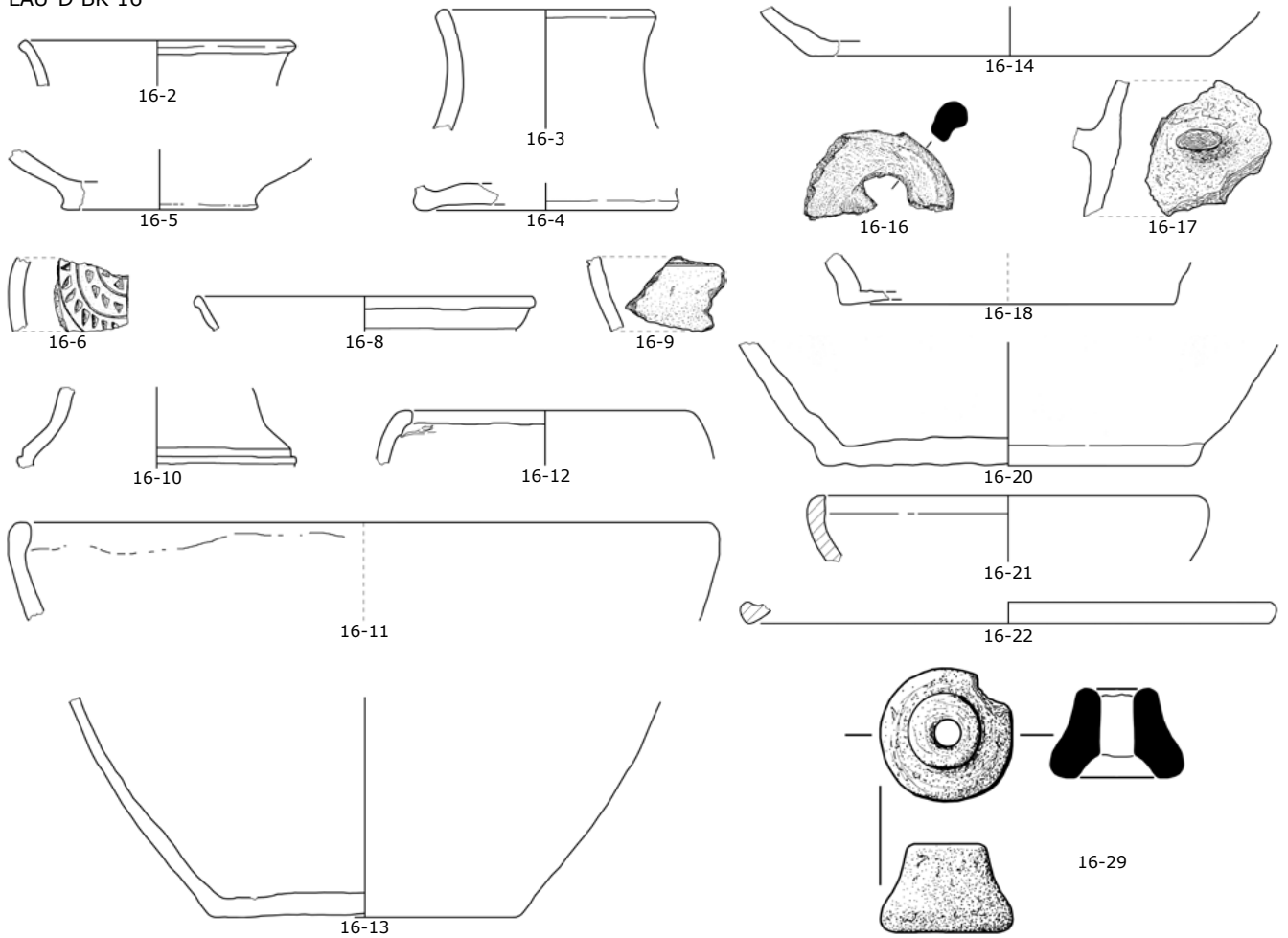

LAU-D BK 17

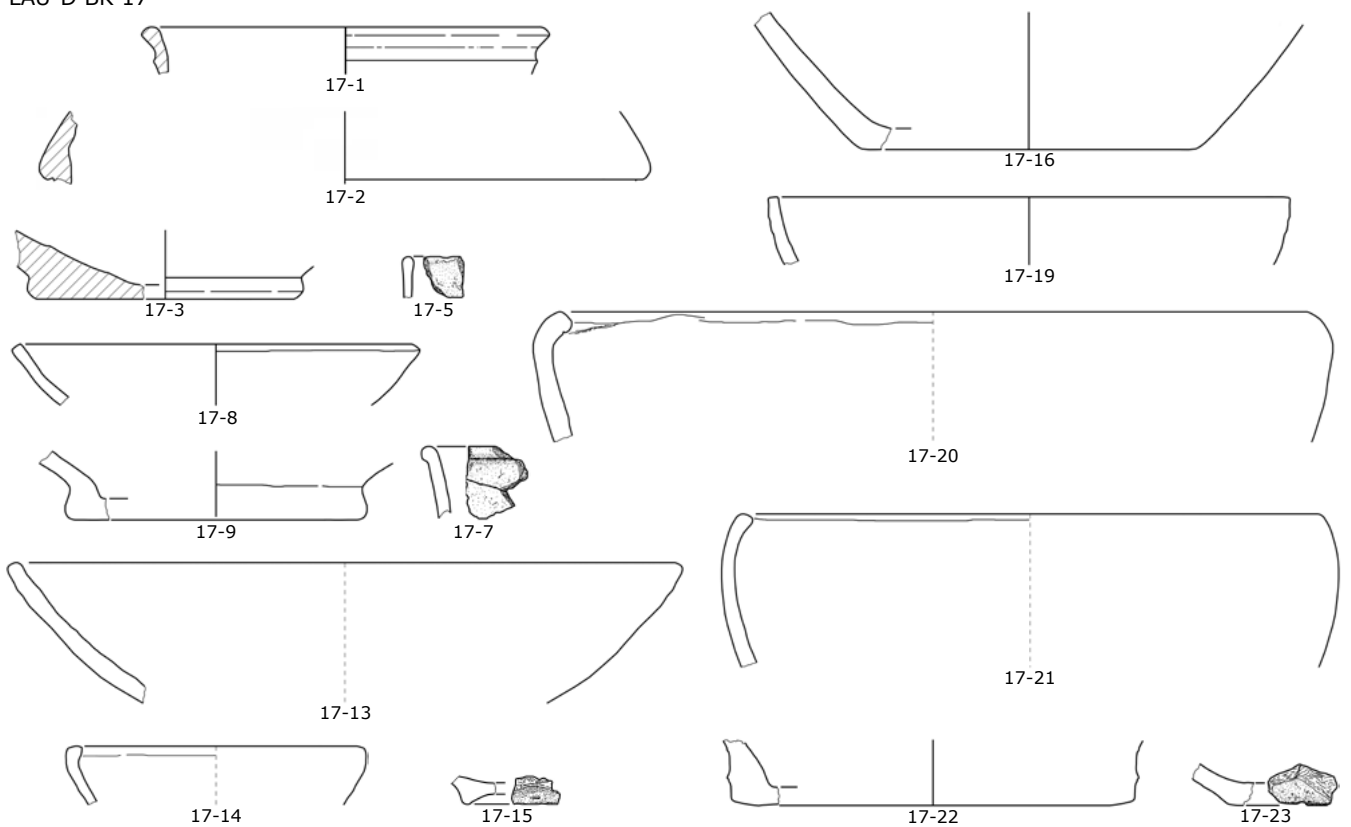

LAU-D BK 17

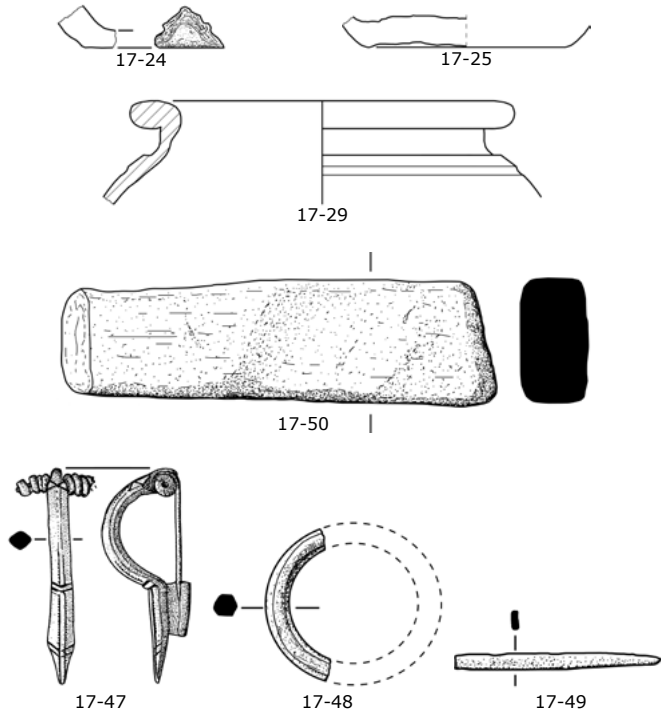

LGG-A

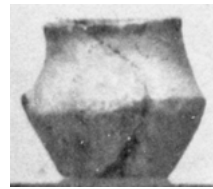

1a
(Foto nach Schliz 1901)

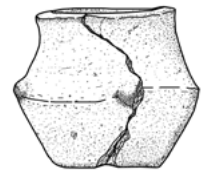

1b
(Fotomzeichnung)

LGG-B

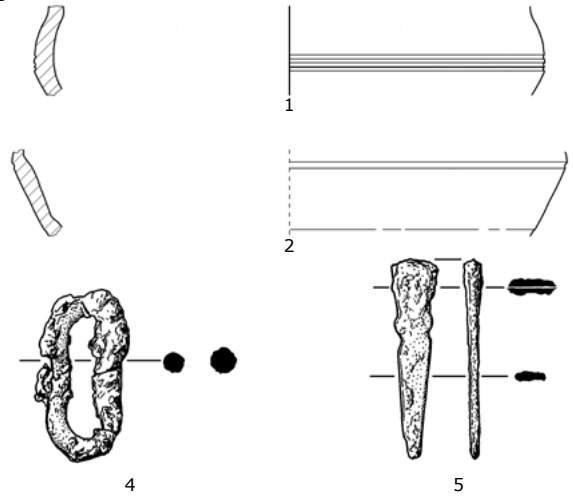

LHS

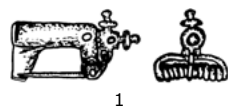

1

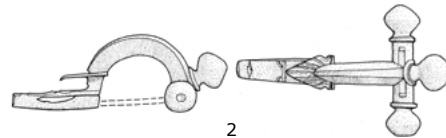

2

NLA

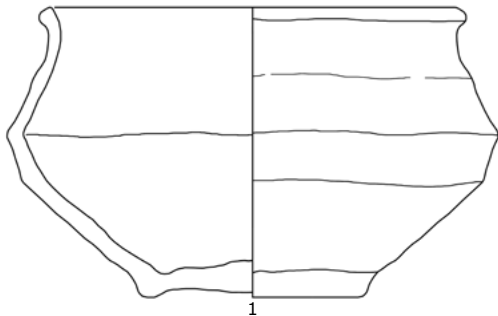

1

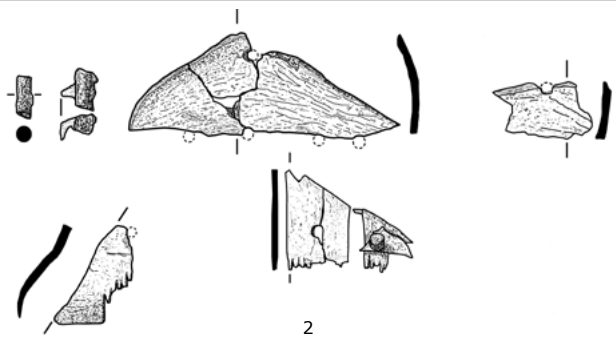

2

OBF-A BK 1

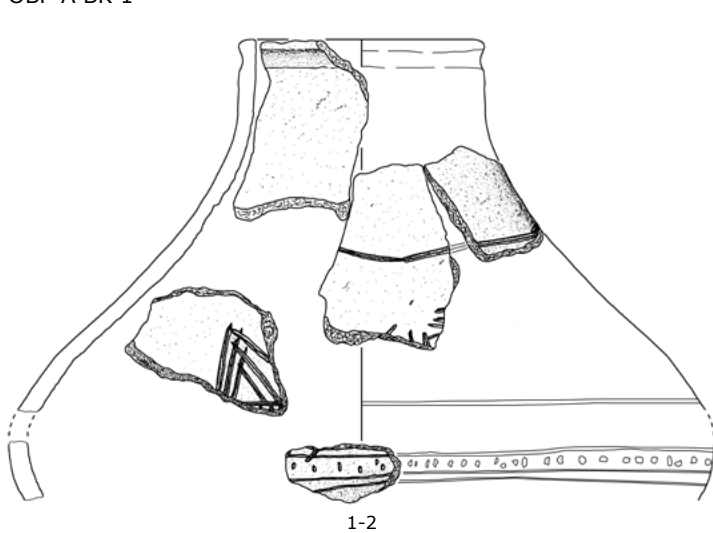

1-2

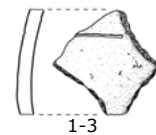

1-3

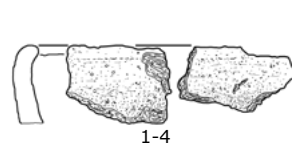

1-4

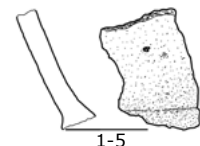

1-5

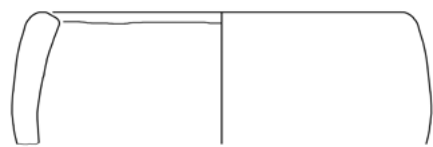

1-7

OBF-A BK 1

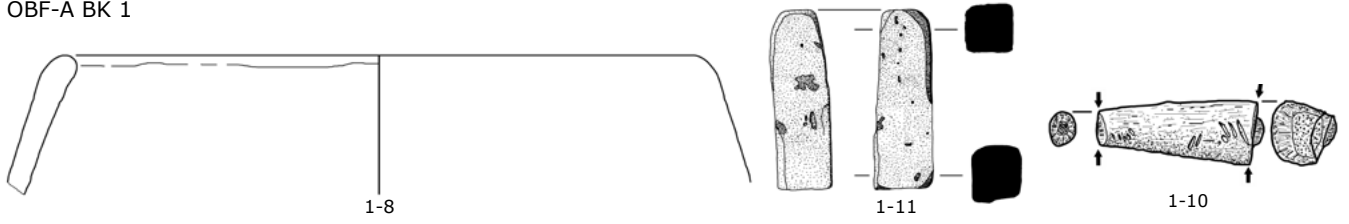

OBF-A BK 2

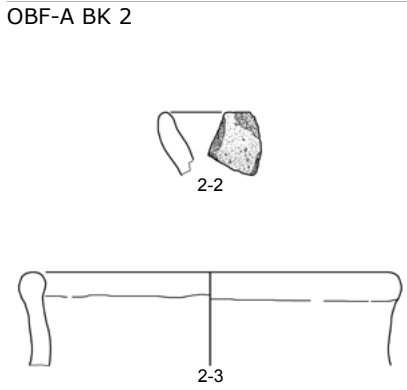

OBF-A BK 3

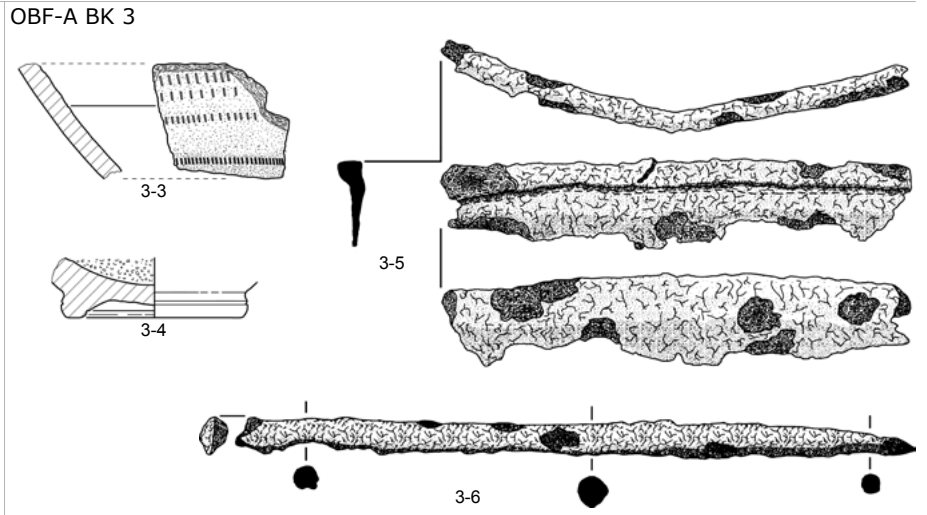

OBF-A BK 4

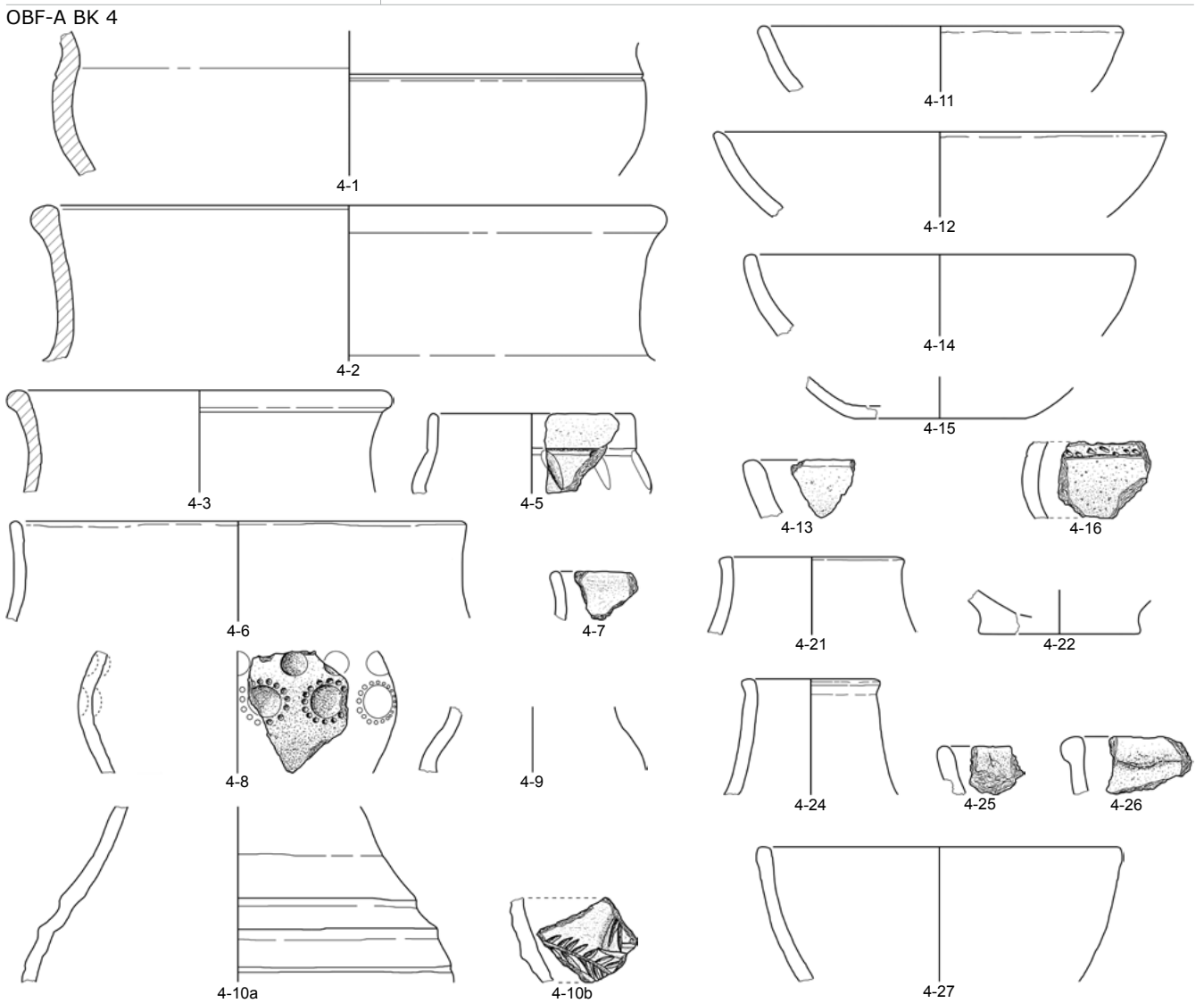

OBF-A BK 4

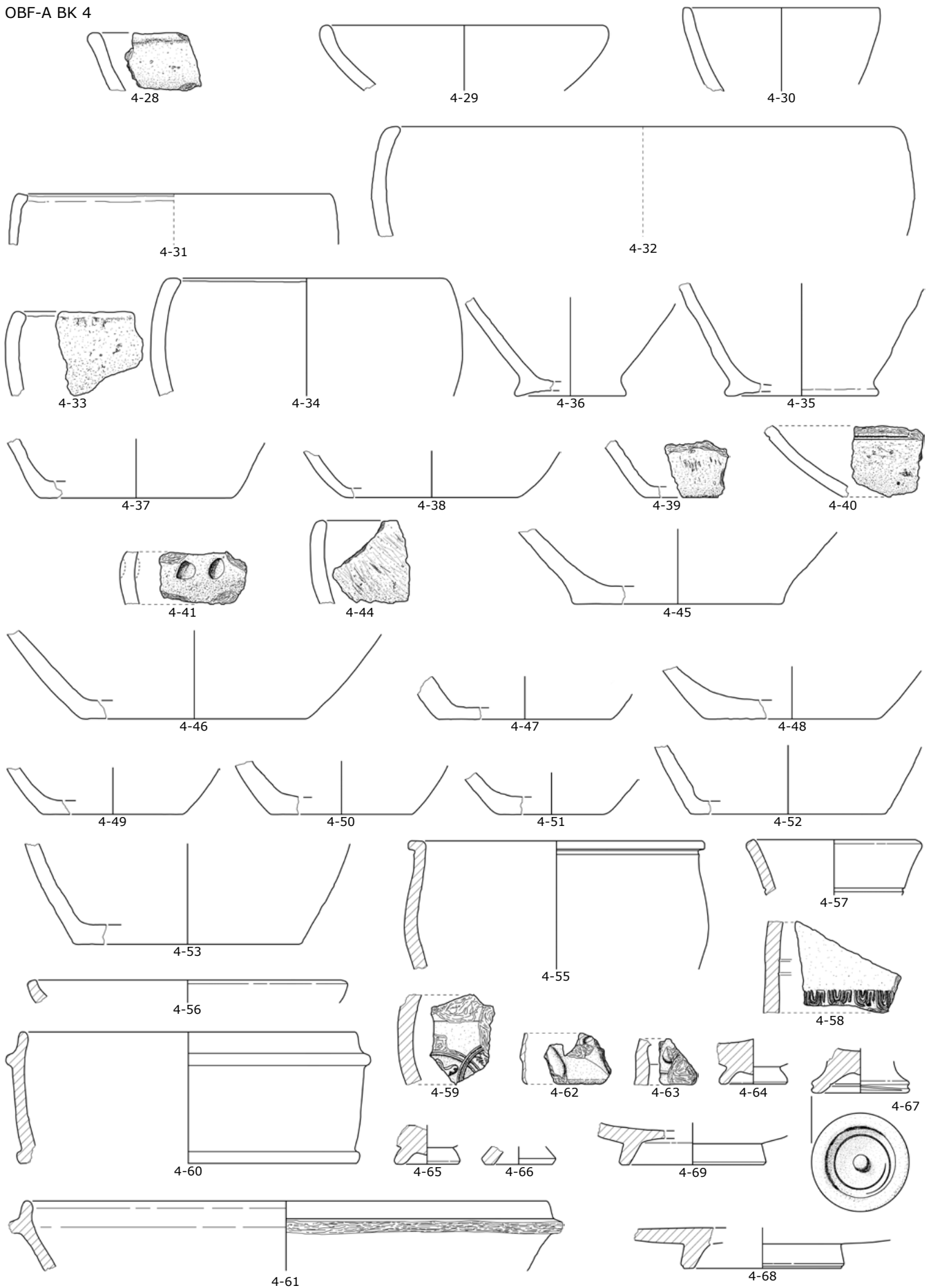

OBF-A BK 4

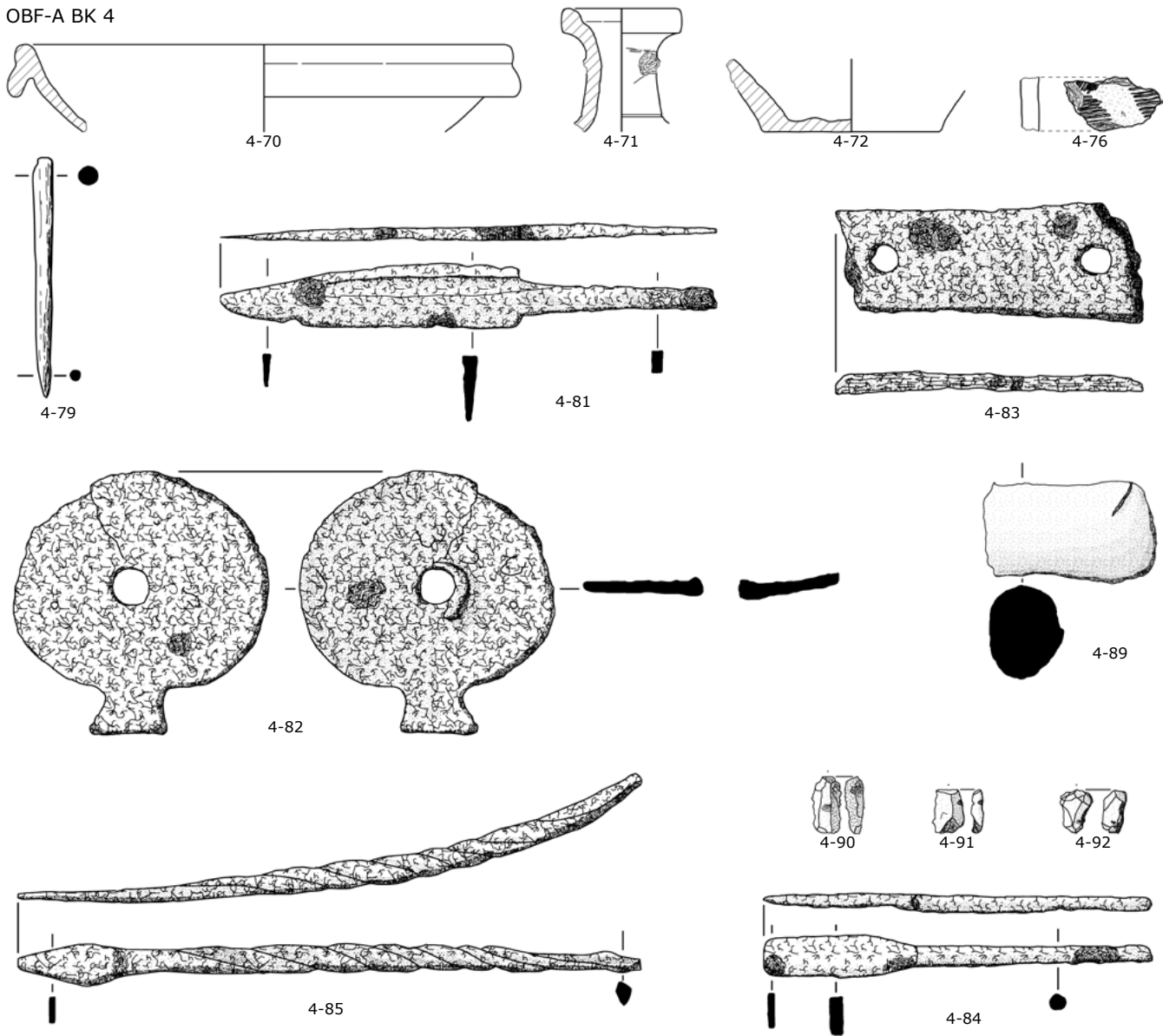

OBF-A BK 5

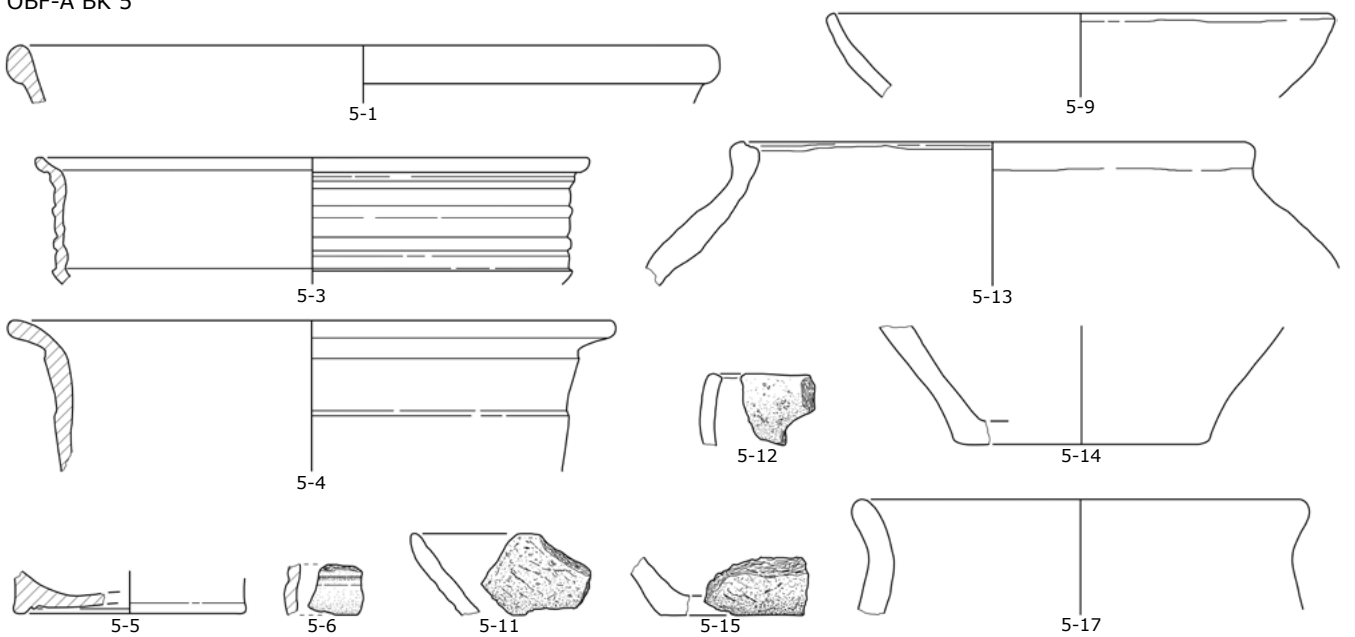

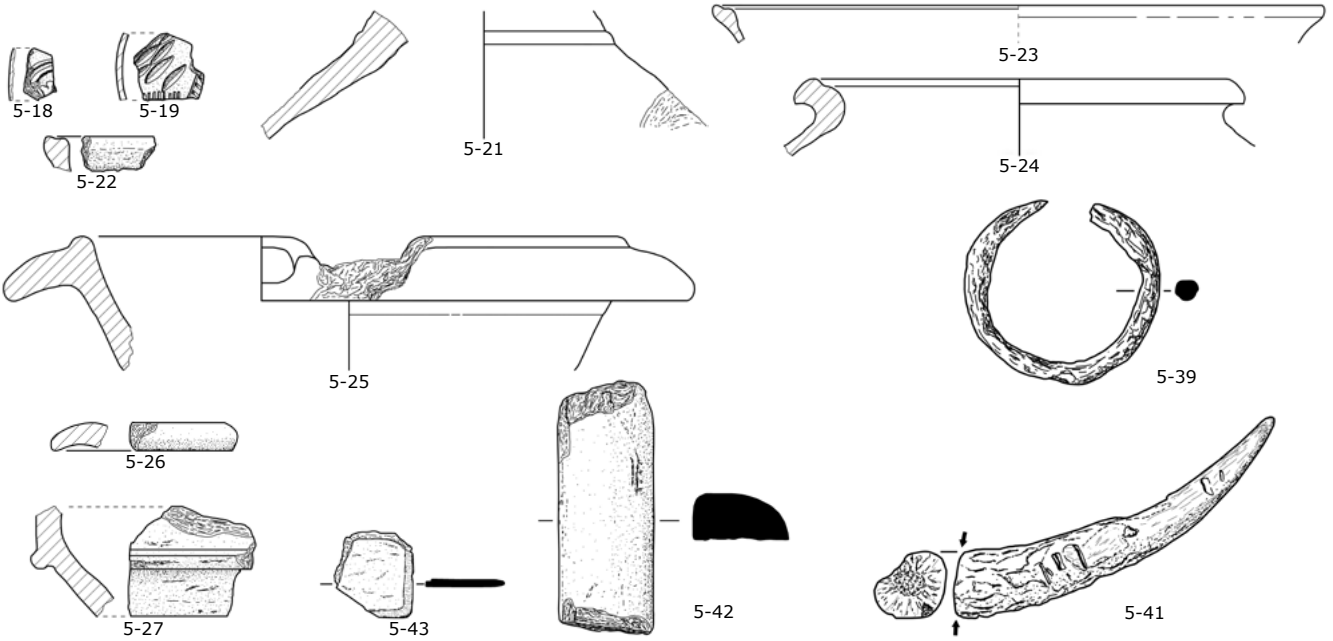

OBF-A BK 6

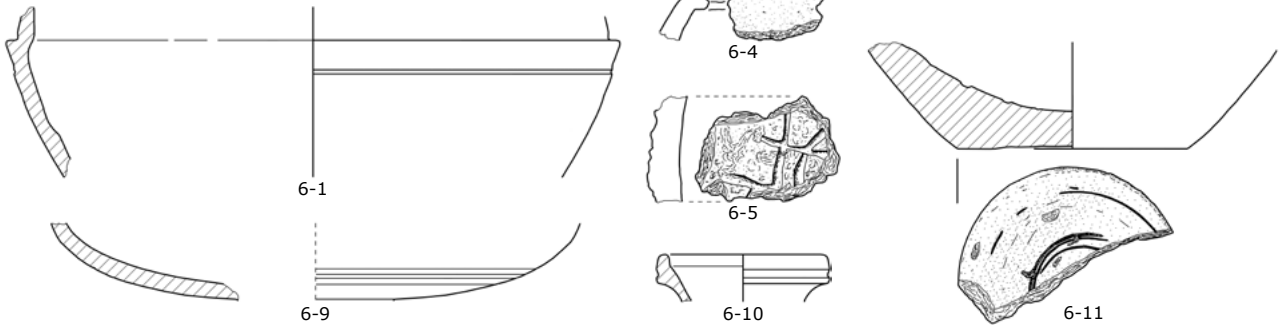

OBF-A BK 7

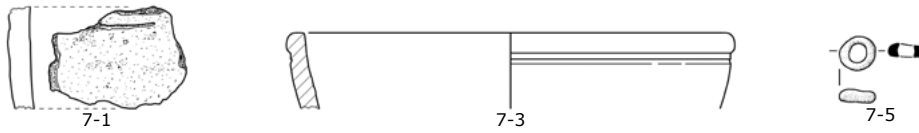

OBF-A BK 8

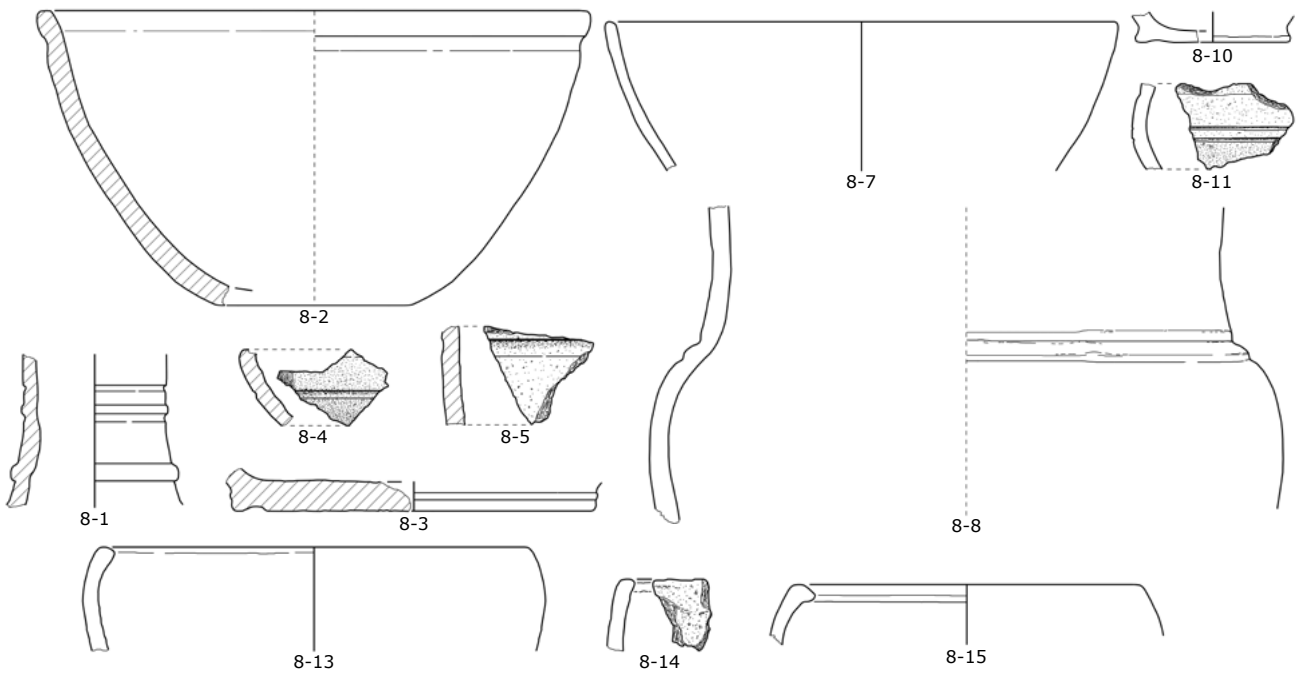

OBF-A BK 8

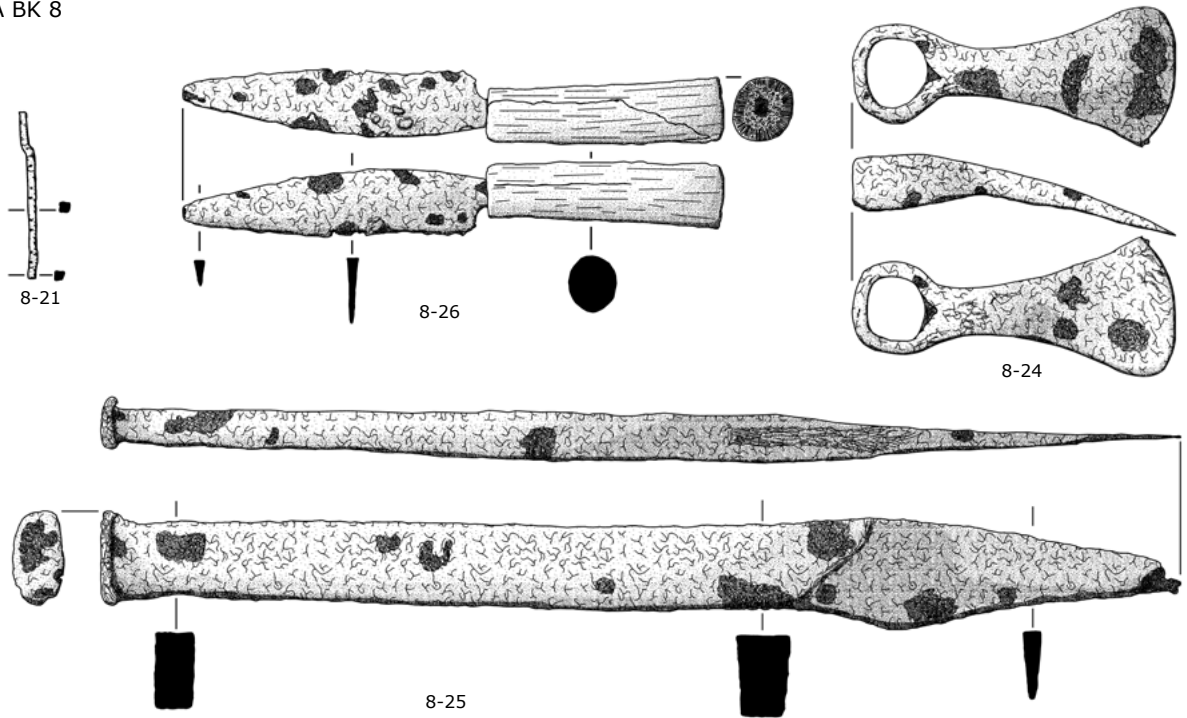

OBF-A BK 12

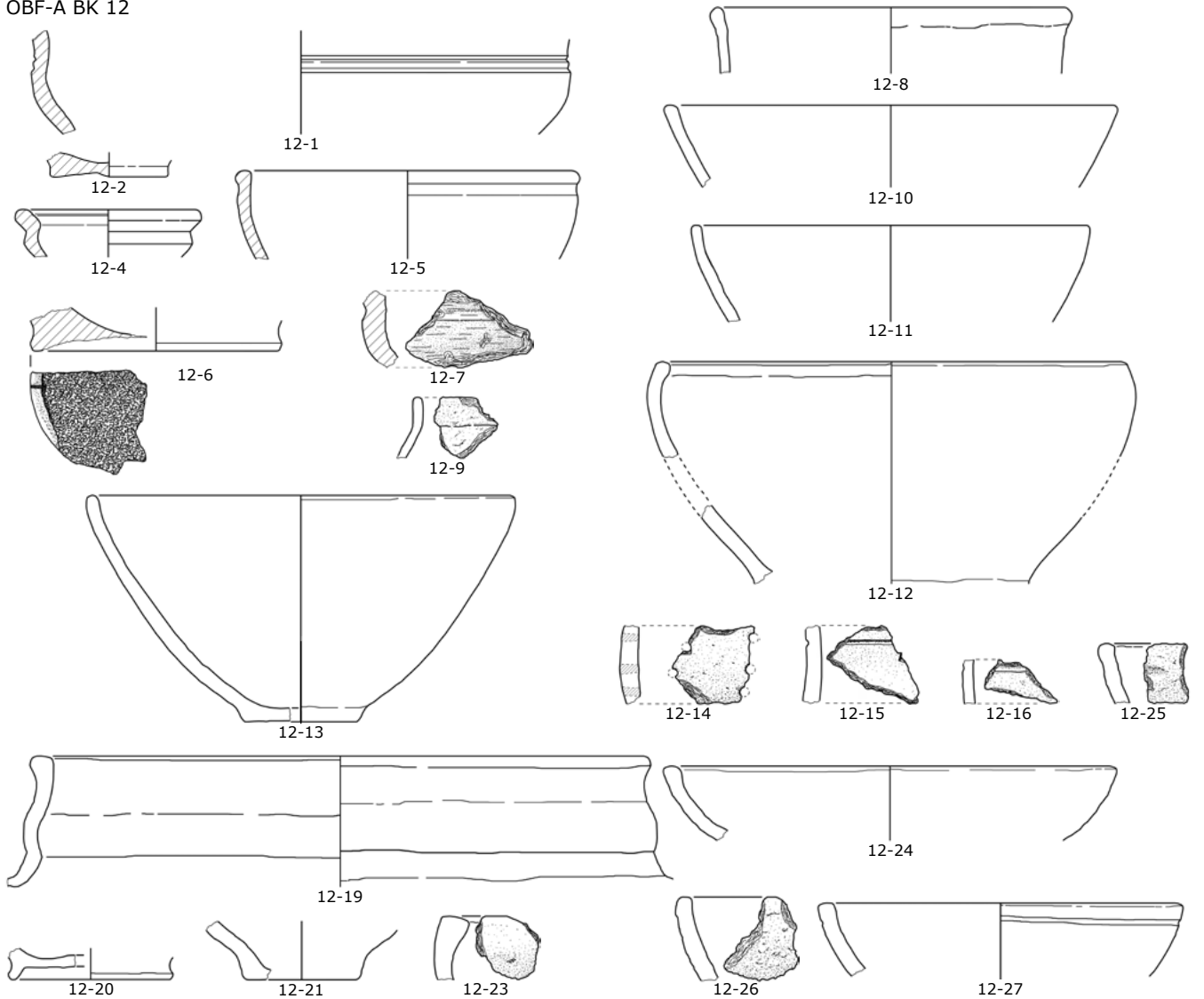

OBF-A BK 12

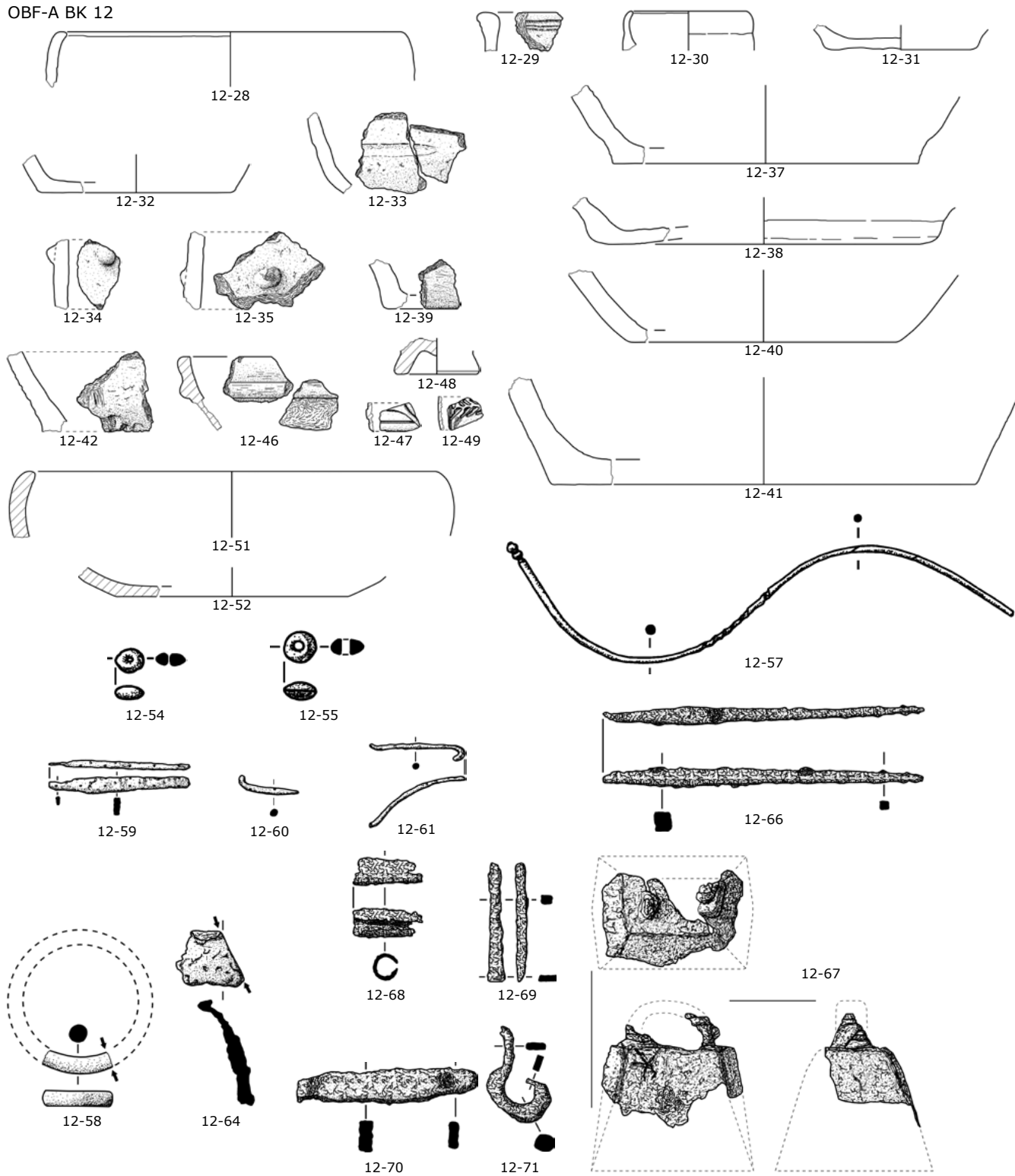

OBF-B

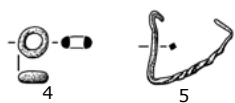

REW

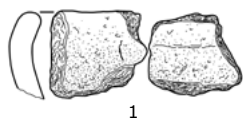

PFO

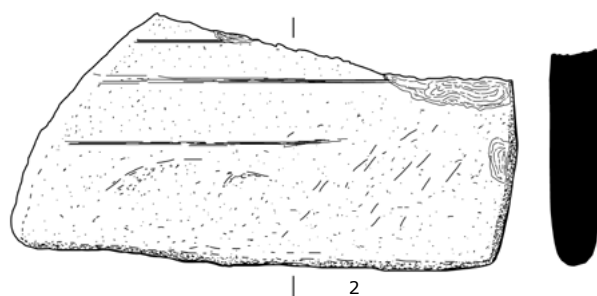
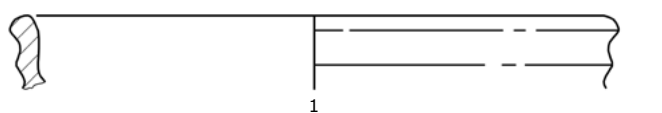

SCH

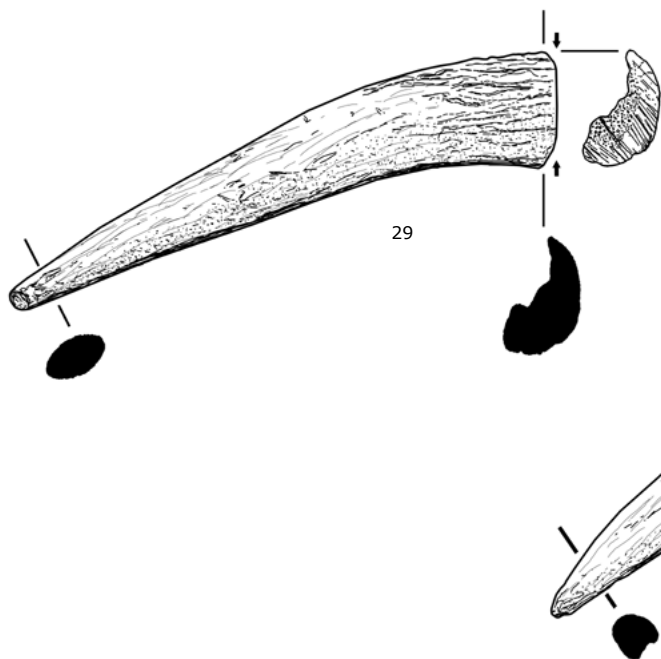
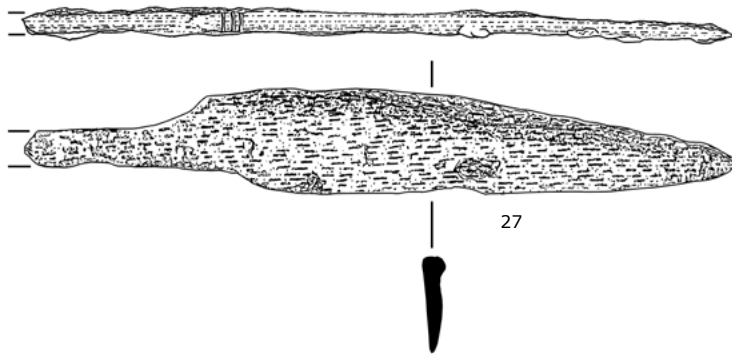
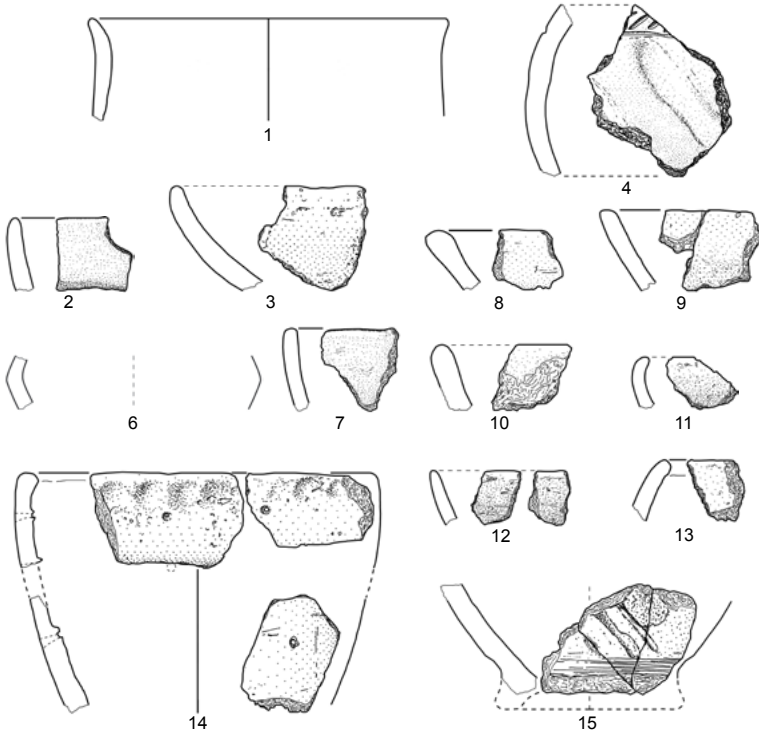

SGS

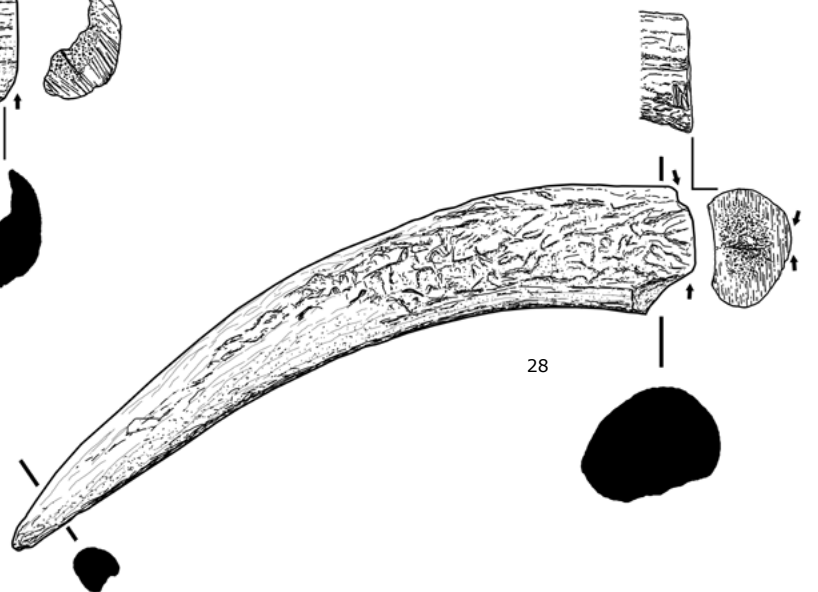
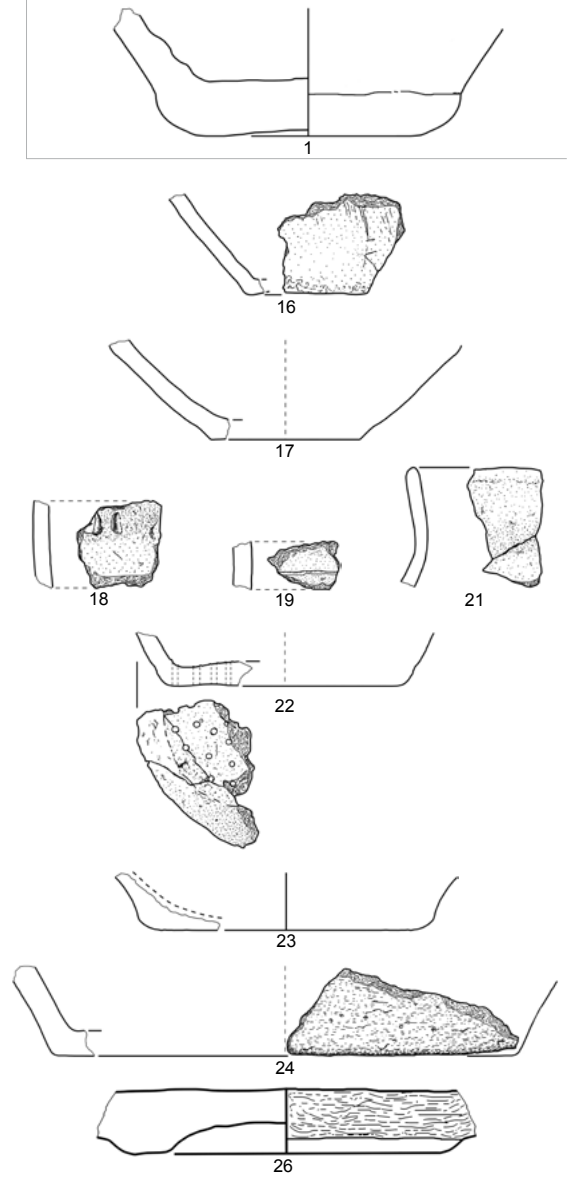

WAH-A

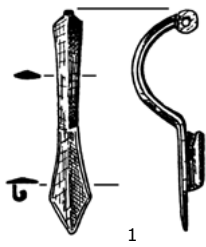

WAH-B

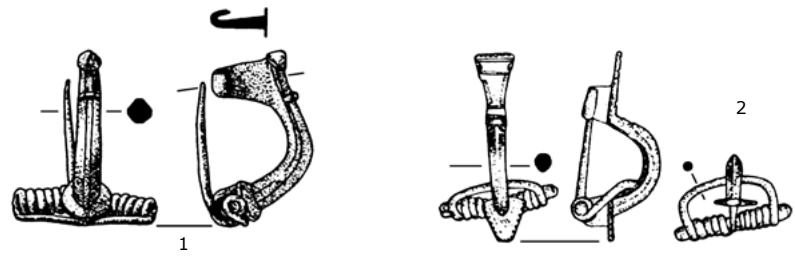

WAL

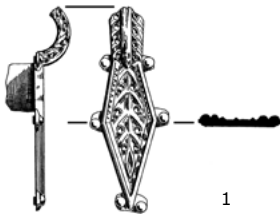

WIE BK 3

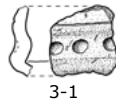

WIE BK 8

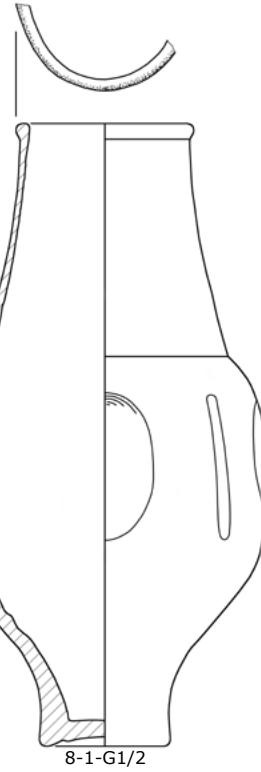

WIE BK 5



WIE BK 7

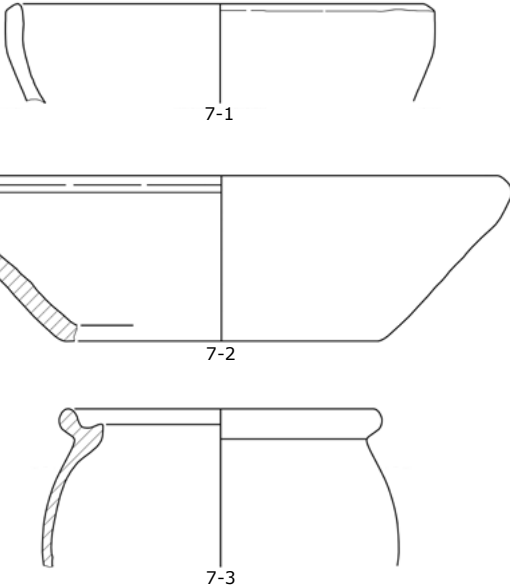

WIE BK 9

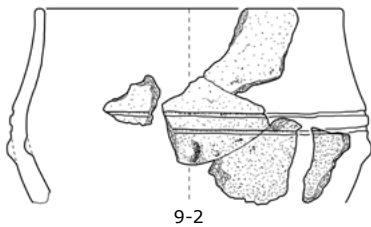

WIE BK 10

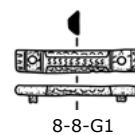
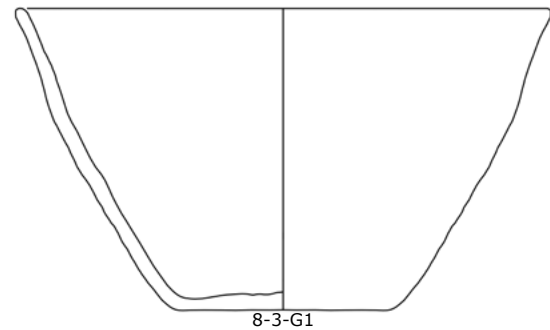
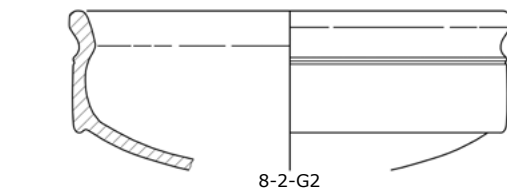
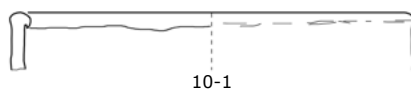

WIE BK 11

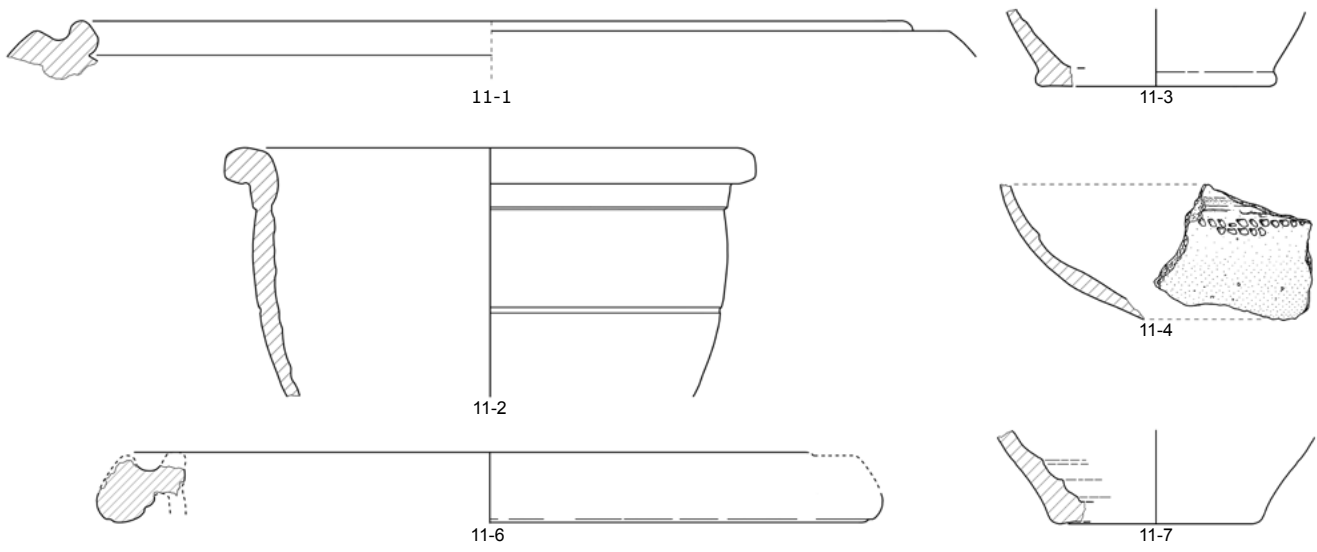

WIE BK 15

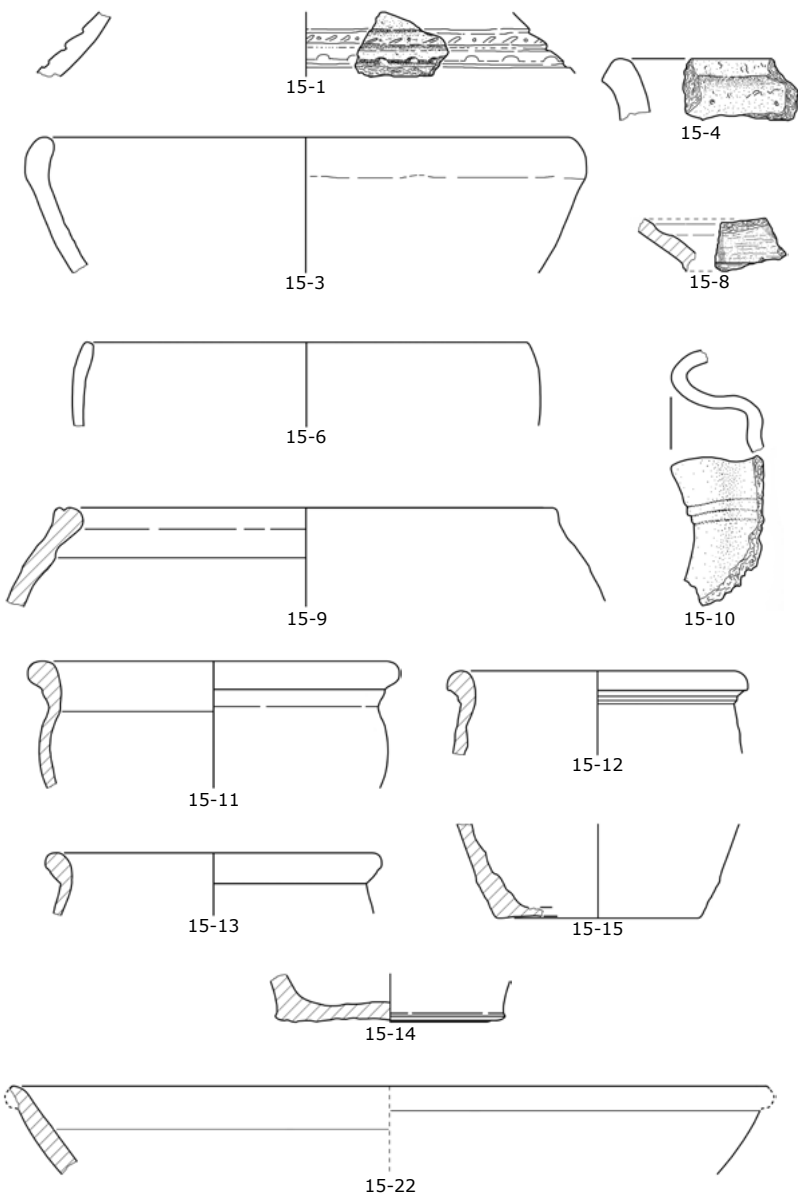

WIE BK 13

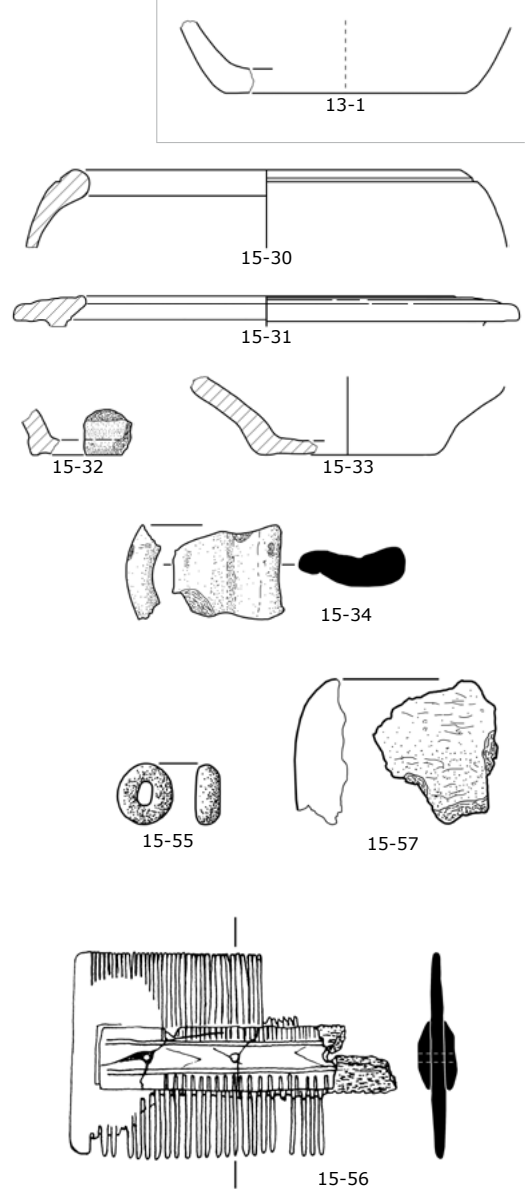

WIE BK 16

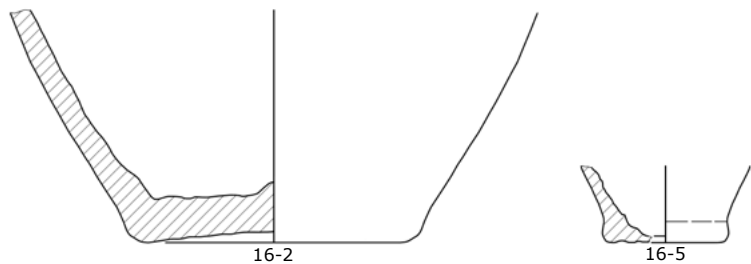

WIE BK 19

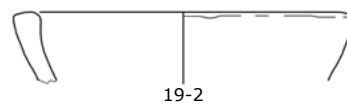

WIE BK 22

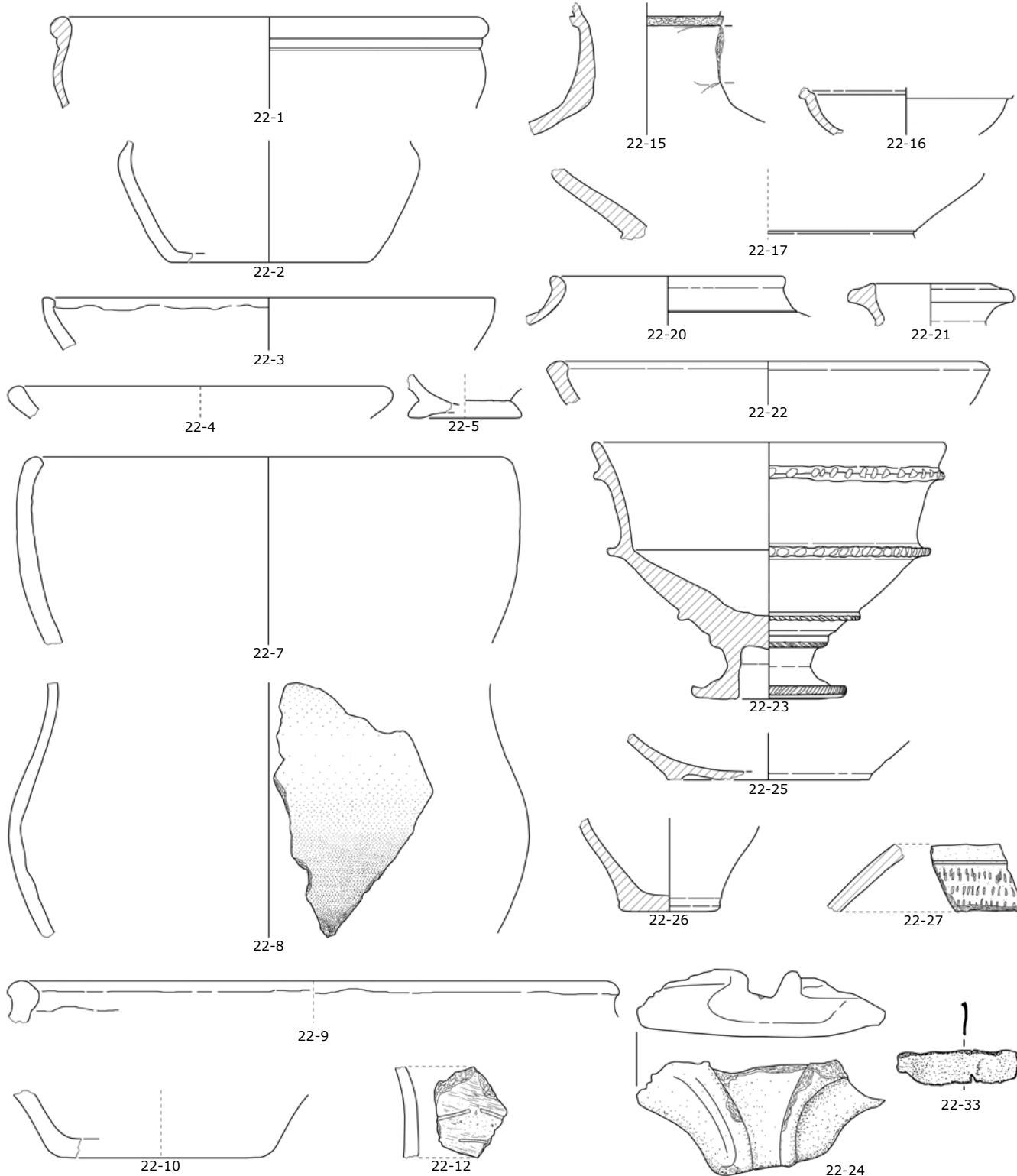

WIE BK 24

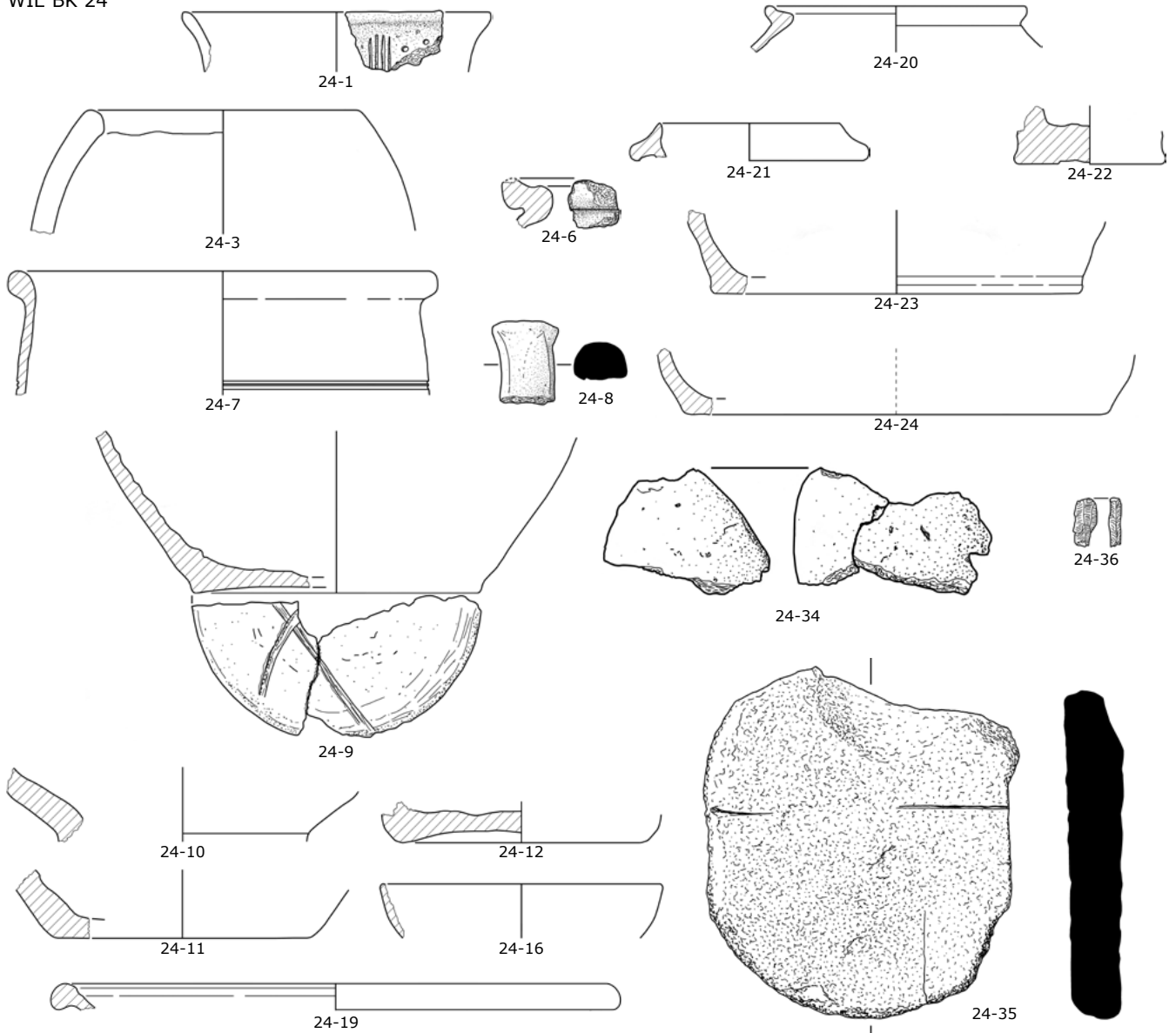

WIE BK 25

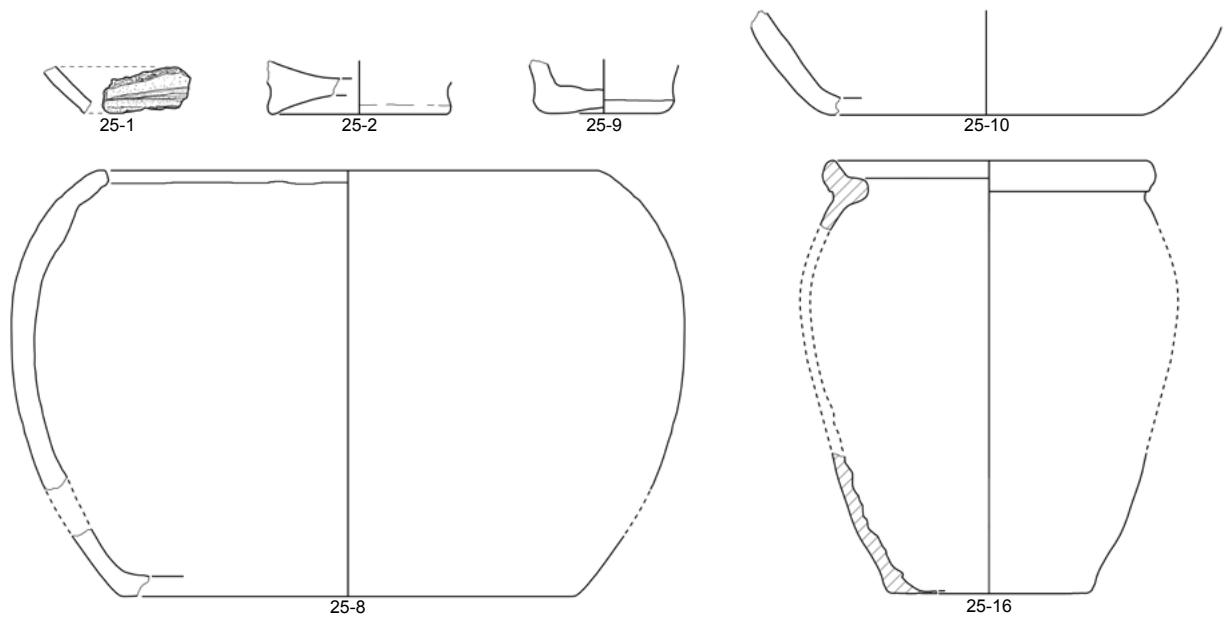

WIE BK 25

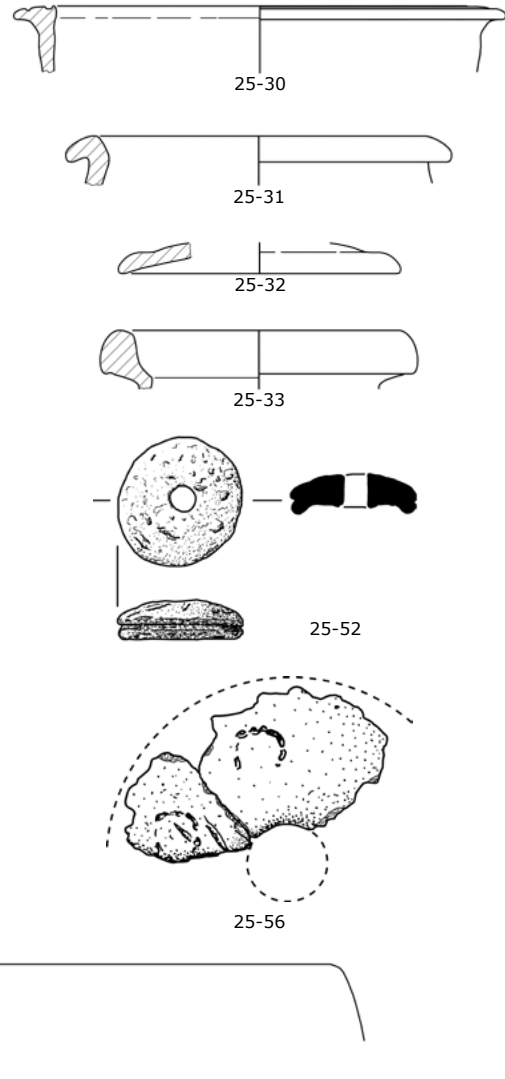
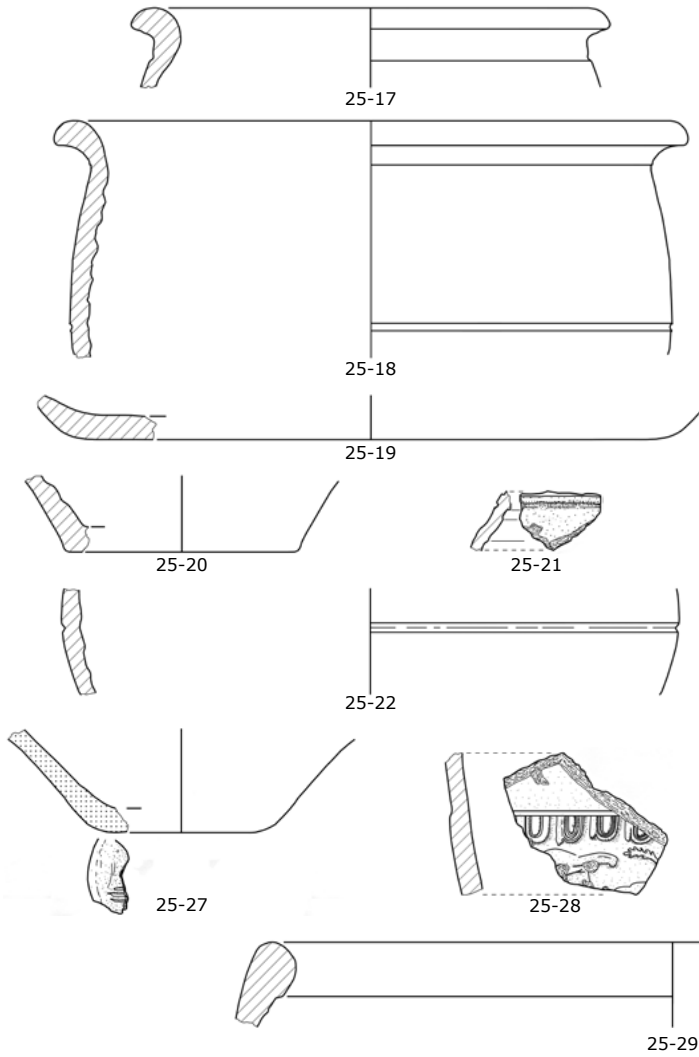

WIE BK 26

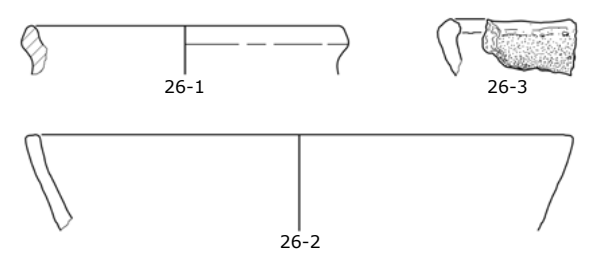

WIE BK 27

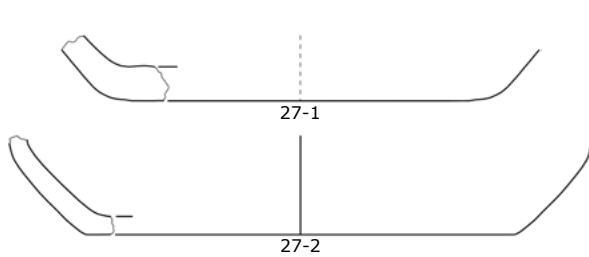

WIE BK 28

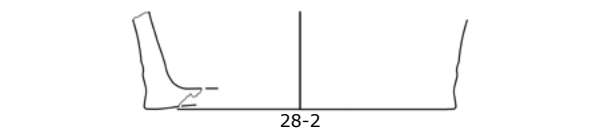

WIE BK 30

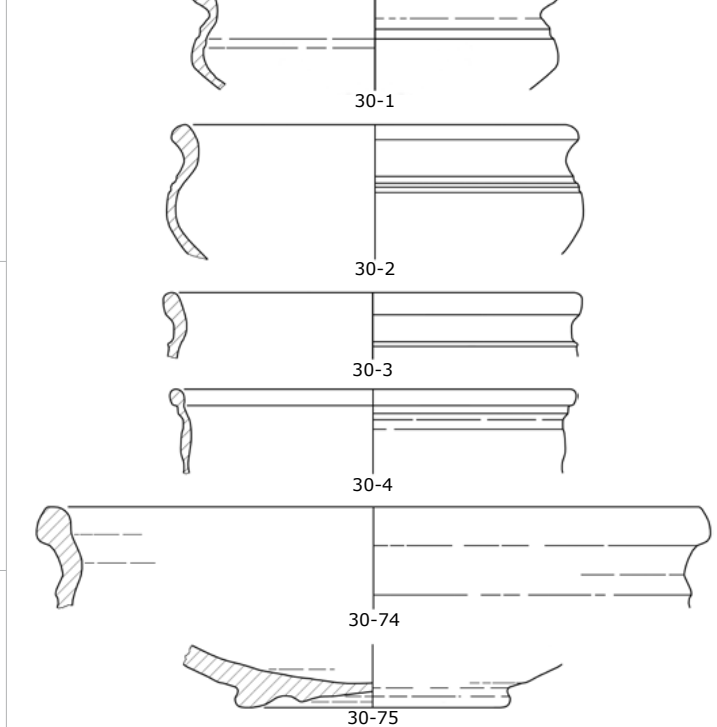

WIE BK 30

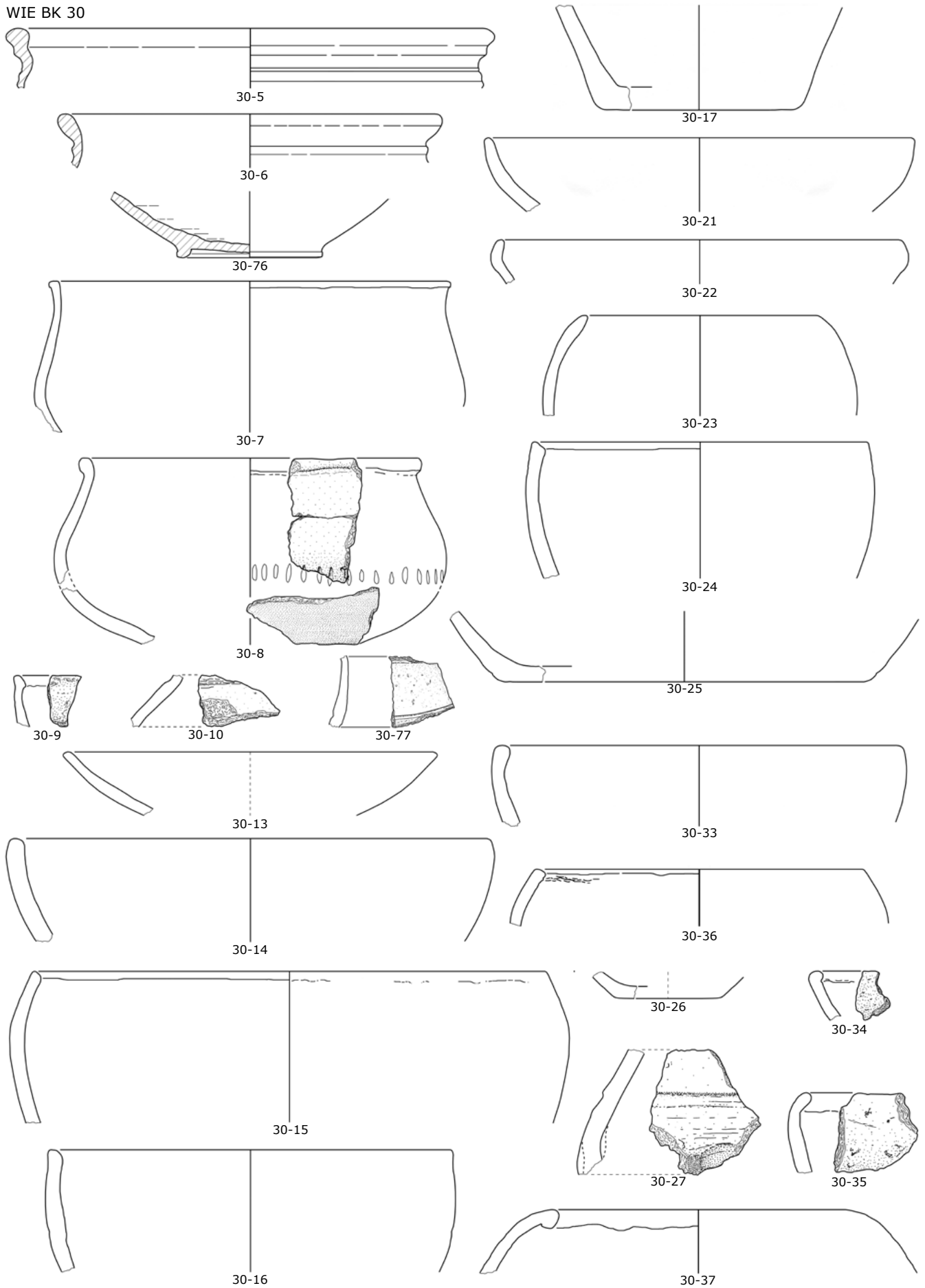

WIE BK 30

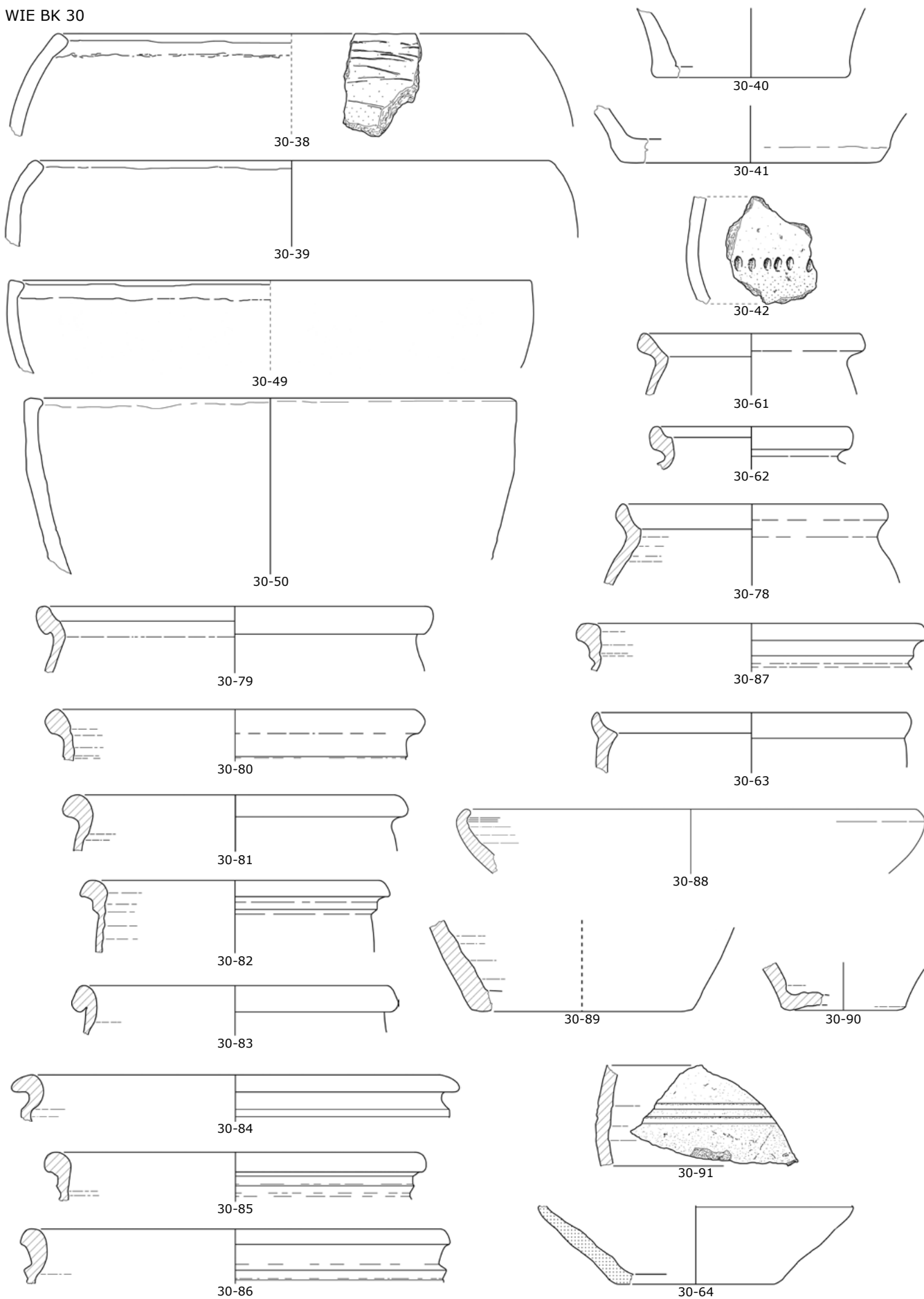

WIE BK 30

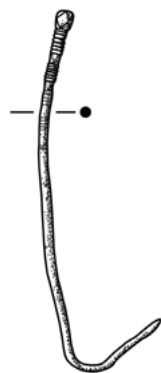

30-69a



30-69b
(Vergrößerung)



30-68



30-72



30-71



30-73



30-70

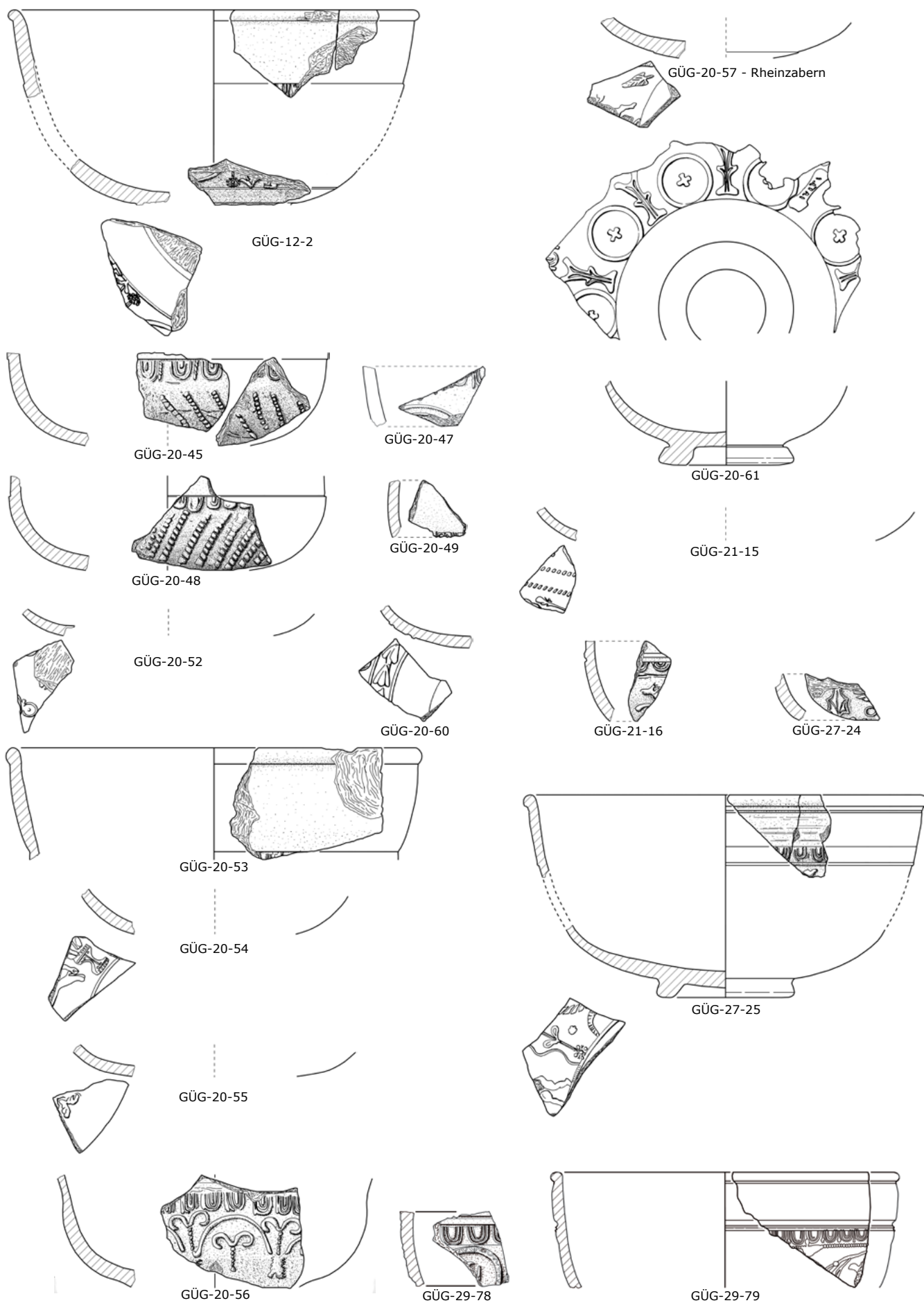

Reliefsigillata. Heiligenberg: GÜG-12-2, GÜG-20-52, GÜG-27-25; Rheinzabern: GÜG-20-45, -48, -52 u. 54-57, GÜG-21-15, GÜG-27-24, GÜG-29-78; Schwäbische Ware: GÜG-21-16; Ware des Saturnius Satto: GÜG-29-79. M. 1:3.

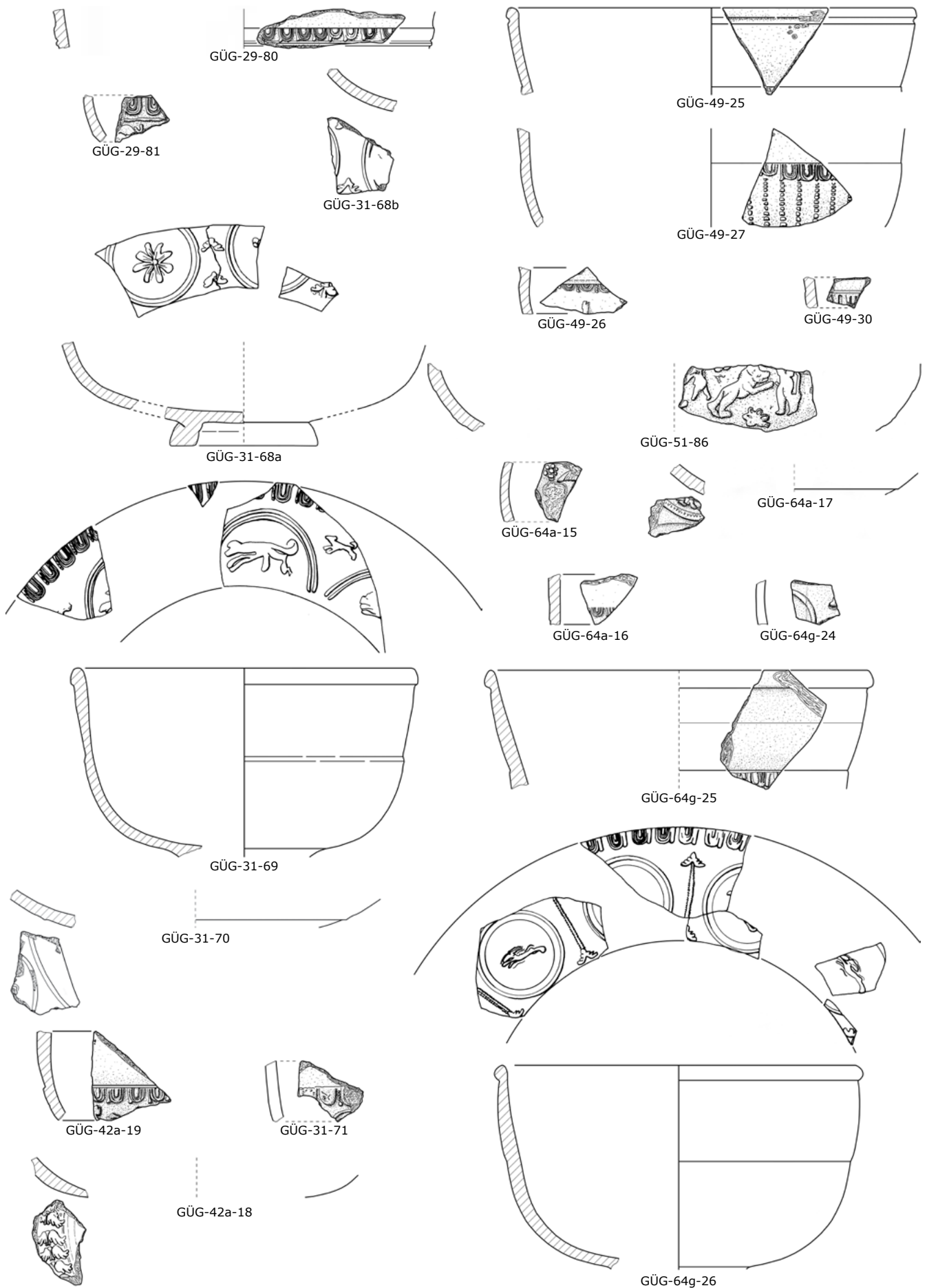

Reliefsigillata. Rheinzabern: GÜG-42a-19, GÜG-31-68a-b u. -69, GÜG-49-26-27, GÜG-51-86, GÜG-64a-15, GÜG-64g-25-26; Schwäbische Ware: GÜG-29-81; Ware des Saturnius Satto: GÜ-29-80, GÜG-42a-18; sonstige: GÜG-31-70-71, GÜG-49-25 u. 30, GÜG-64a-16-17, GÜG-64g-24. M. 1:3.

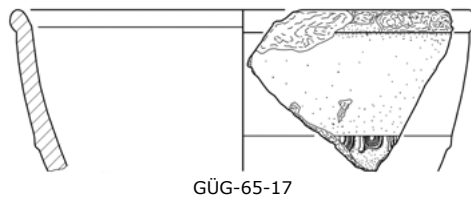

Nb. 89 URM: Topf mit Deckelfalz und herzförmigem Profil

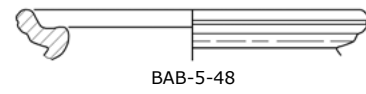
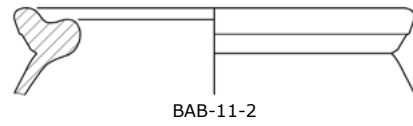
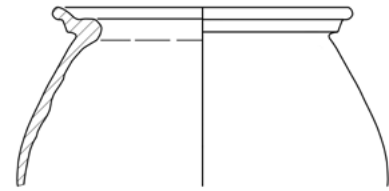
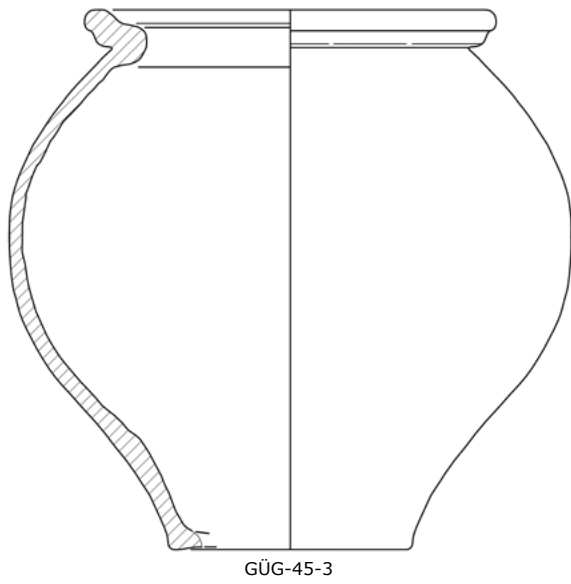

Nb. 102 URM: Schüssel mit gerilltem und ausbiegendem Rand

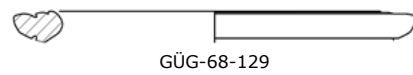
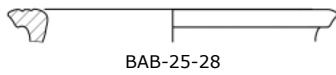

Nb. 103 URM: Schüssel mit Deckelfalz und herzförmigem Profil

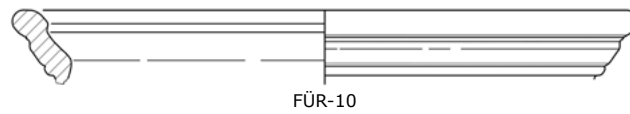
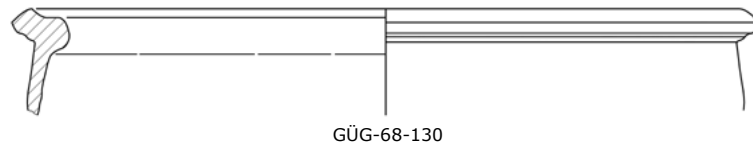
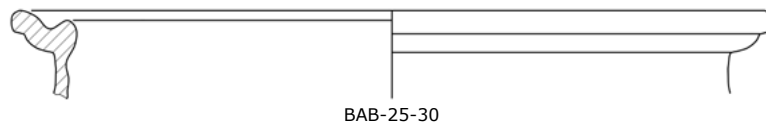
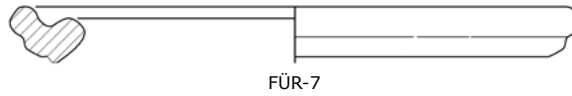

Nb. 104 URM: Schüssel mit Deckelfalz und herzförmigem Profil

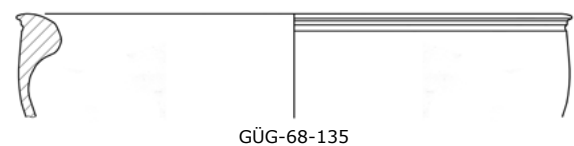
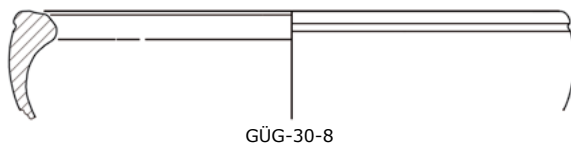
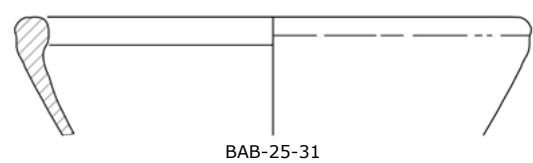
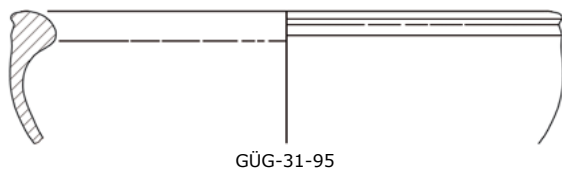

Nb. 105 URM: Schüssel mit nach innen umgelegten Kehlrand

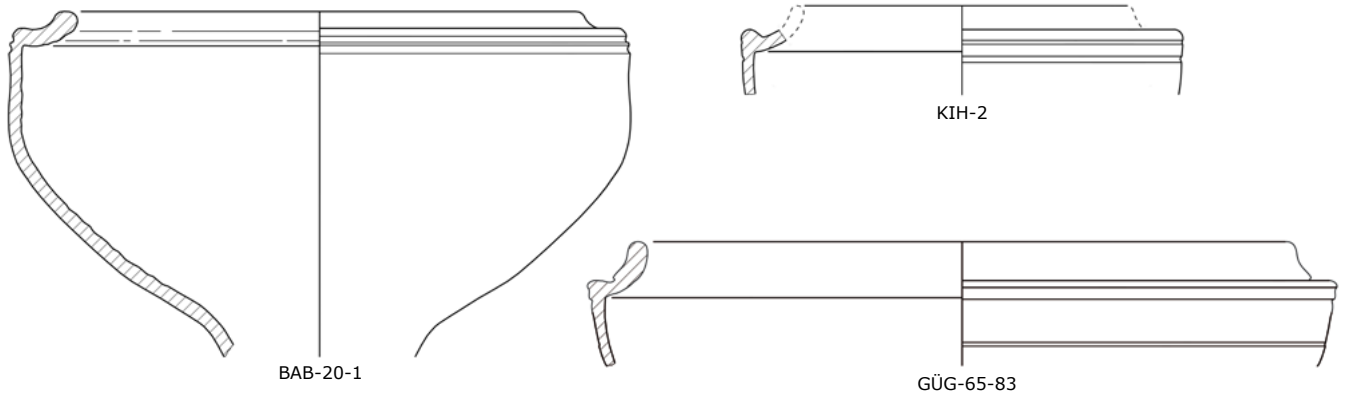

Nb. 111 URM: Teller mit einwärts gebogenen und leicht verdicktem Rand

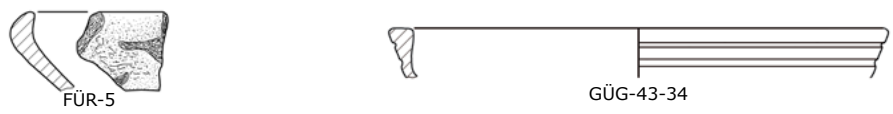

Nb. 112 URM: Teller mit Schrägwand und innen profiliertem Rand

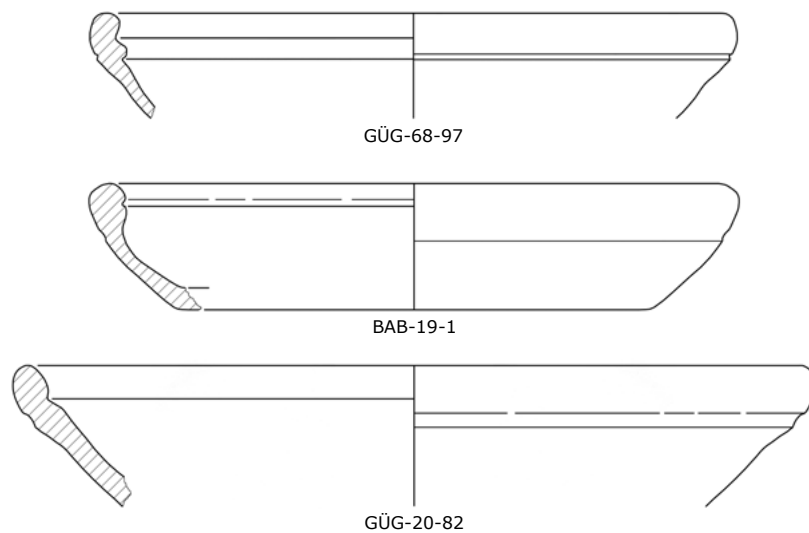

Nb. 113 URM: Teller mit Steilrand

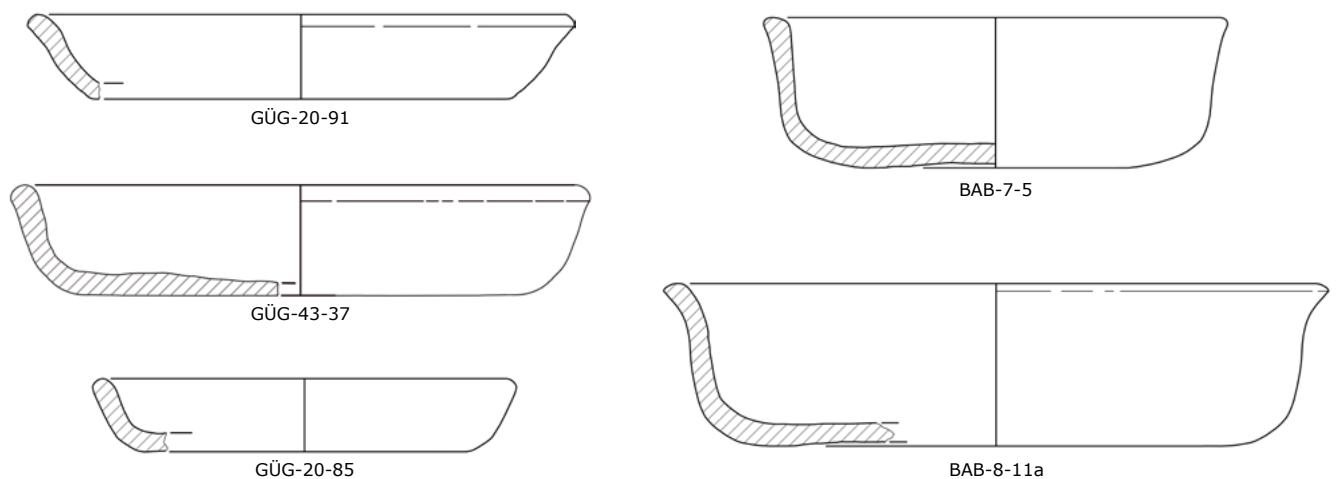

Nb. 98 URM: Birnenförmige Kanne

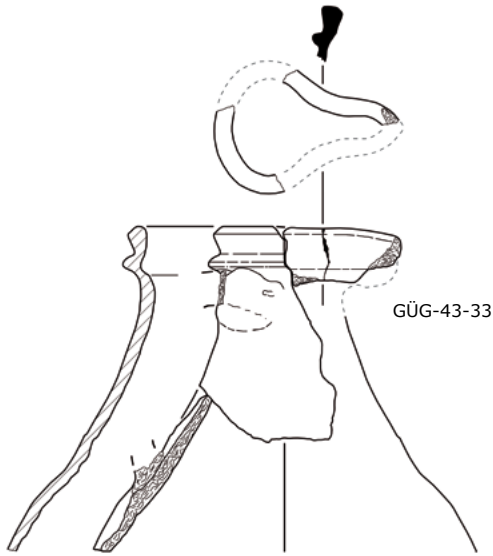

Nb. 120 URM - Deckel

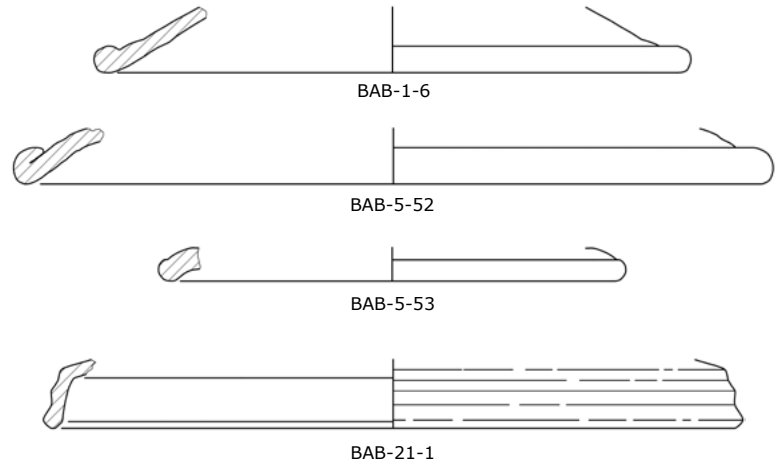

Curle 15 TS: Teller mit auswärts gebogener Wand und Randleiste

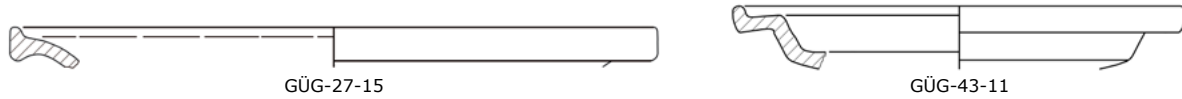

Drag. 18/31 TS: Teller mit schräger Wand und rundstabiger Lippe

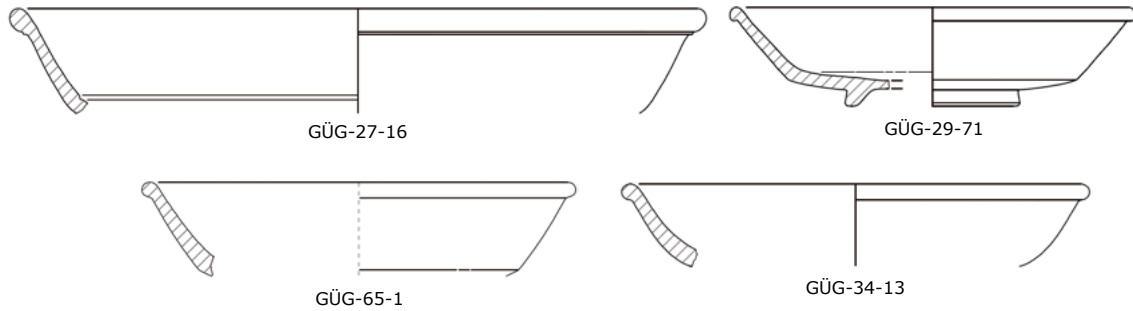

Drag. 32 TS: Teller mit gerundeter Wand

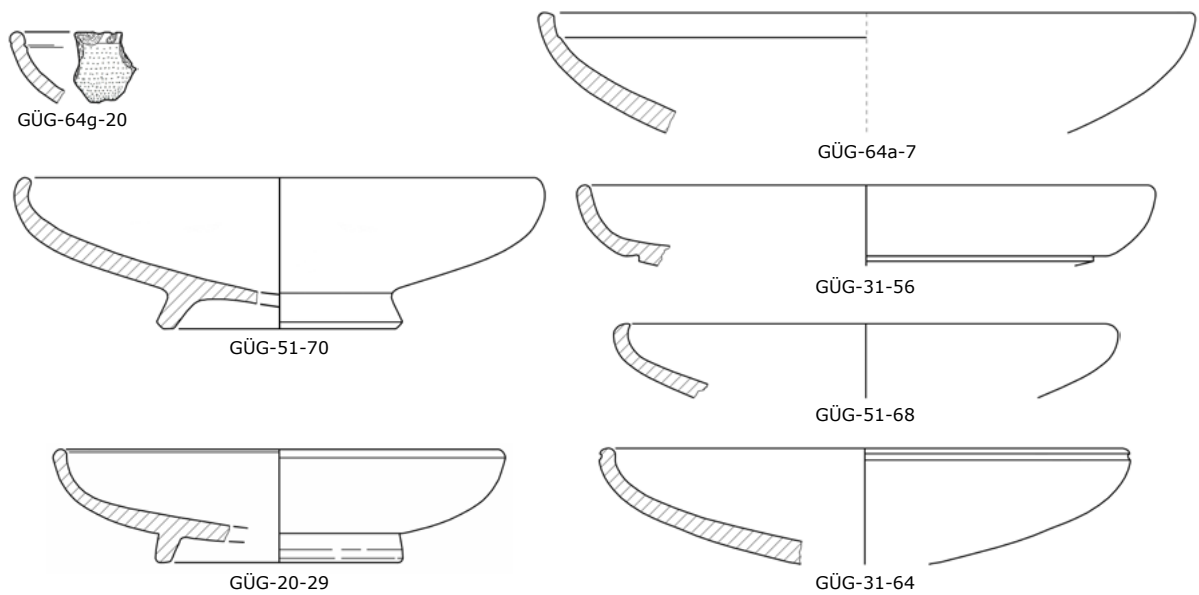

Nb. 6 TS: Teller mit gerundeter Wand und Wandleiste

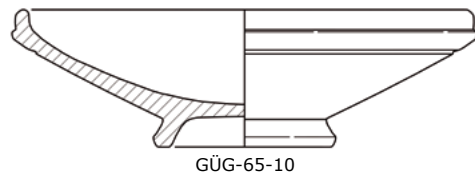
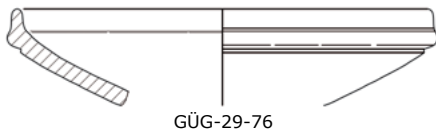

Nb. 6 Var./Gose 101 TS: Teller mit gekehlter Wand und Wandleiste

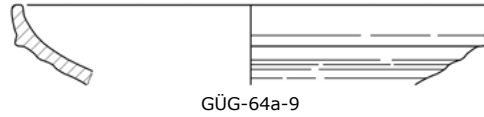

Drag. 27 TS: Napf mit eingeschnürter Wandung

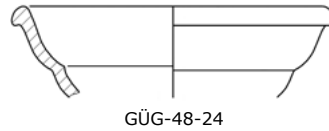
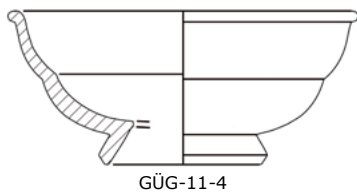

Drag. 33 TS: Konischer Napf

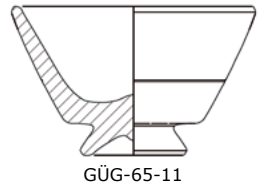
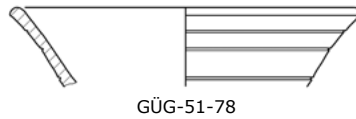
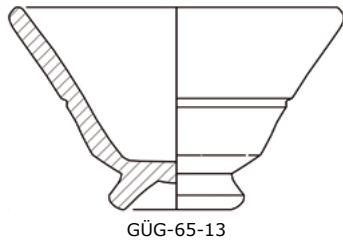
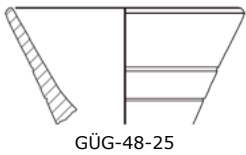

Drag. 35/36 TS: Napf/Teller mit umgeschlagenem Rand

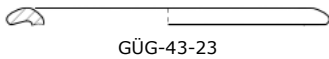

Drag. 40 TS: Halbkugeliger/kalottenförmiger Napf

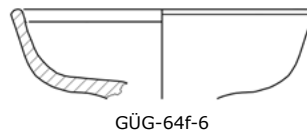

Lud. Sp/Sq

TS: Flacher Napf mit Rundstabilippe



Nb. 8 TS: Konischer Napf mit umgeschlagenem oder verdicktem Rand

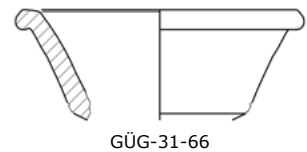

Nb. 15 TS: Halbkugeliger Napf mit Rundstabilippe



Nb. 16 TS: Napf/Schüssel mit Rundstabilippe und Kerb-/Ratterdekor



Nb. 11/Gellep 29/ Gose 46

TS: Napf mit nach außen geschlagenem Rand

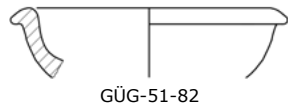
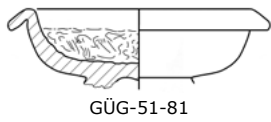

Drag. 38 TS: Kragenschüssel

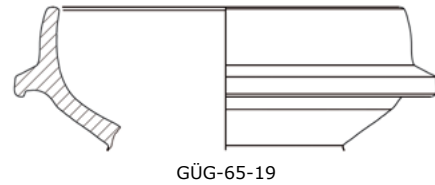
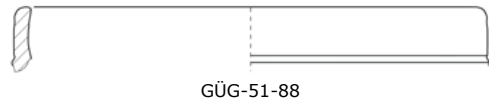
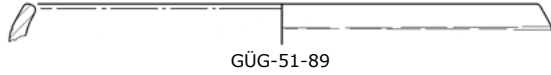

Drag. 44 TS: Schüssel mit Wandleiste

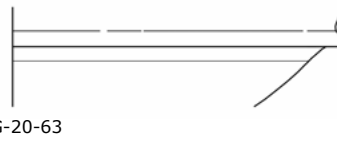

Nb. 19 TS: Schüssel mit Rand- und Wandleiste

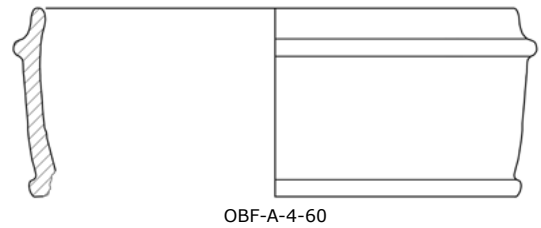
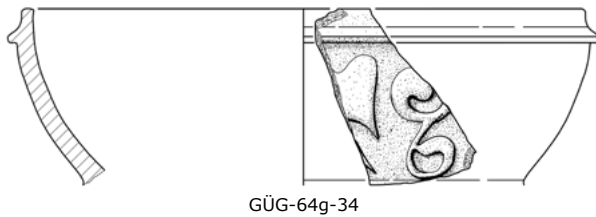

Drag. 39 TS: Platte mit gegenständigen Griffplatten

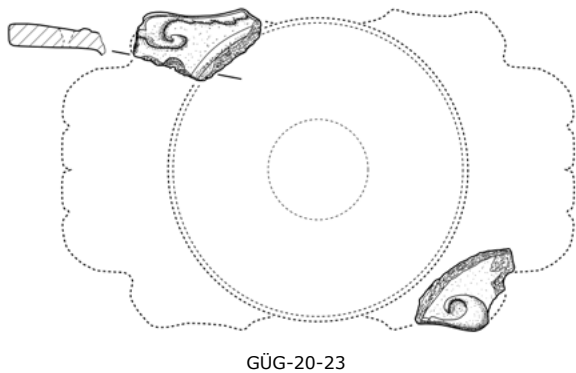

Drag. 41 TS: Fußloser Becher mit Kerbschnittdekor

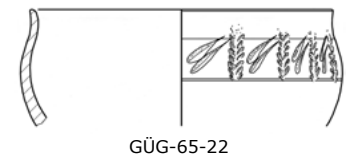
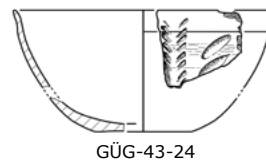
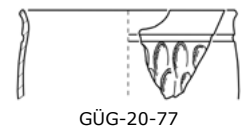
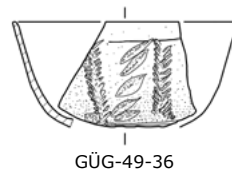

Drag. 54 TS: Kugeligter Becher mit zylindrischem Hals

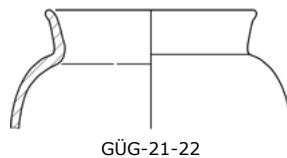

Drag. 43 TS: Reibschüssel mit Kragenrand

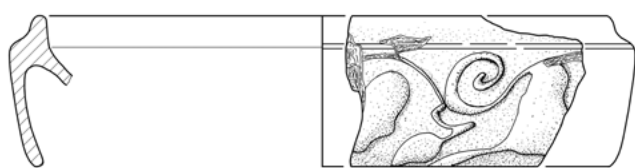

GÜG-20-66

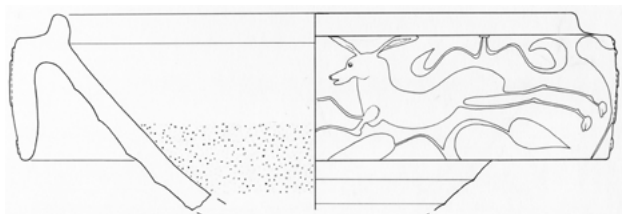

GÜG-49-33

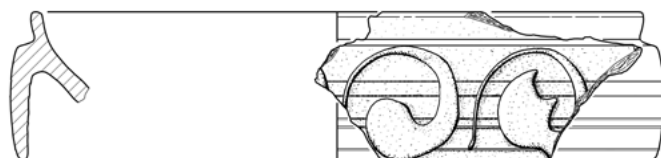

GÜG-27-27

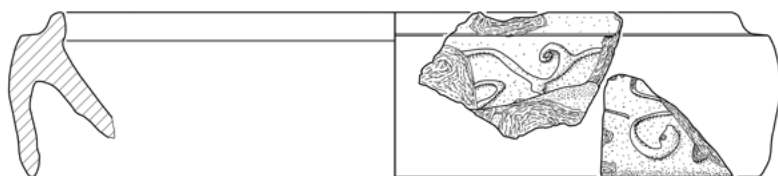

GÜG-51-90

Hof. 109a TN: Knickwandschüssel



GÜG-29-83

Hof. 115/116 TN: Schüssel mit S-förmigem Profil

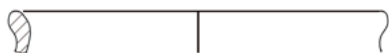

GÜG-42a-20



GÜG-48-28



GÜG-65-28

Nb. 24 TS: Bauchiger Becher



GÜG-43-31

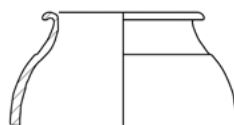

GÜG-49-37



GÜG-65-23

Drag. 53 TS: Krug/Kantharos



GÜG-31-53



GÜG-43-32



GÜG-49-38

TS: Standring von Krug oder Becher

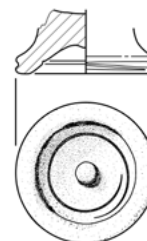

OBF-A-4-67

Hof. 129 TN: Kragenschüssel

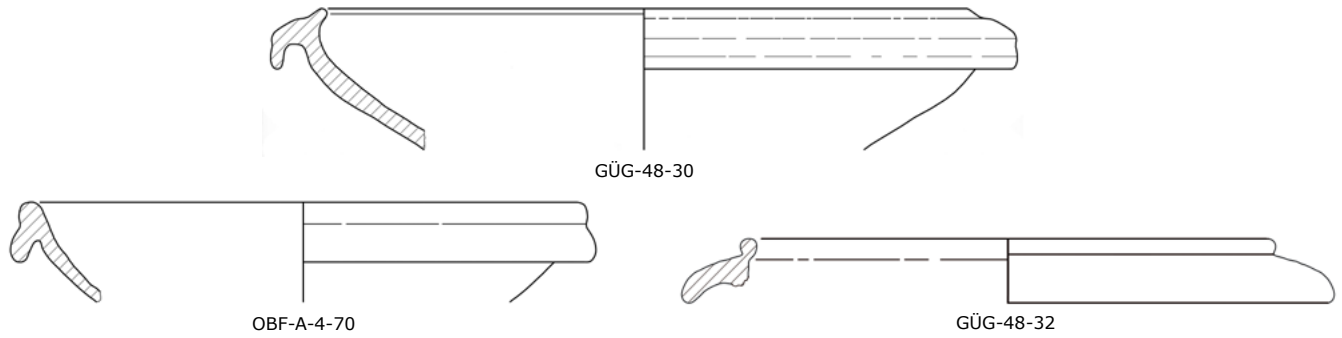

Pf. N2 TN: Schüssel mit ausbiegendem Rand

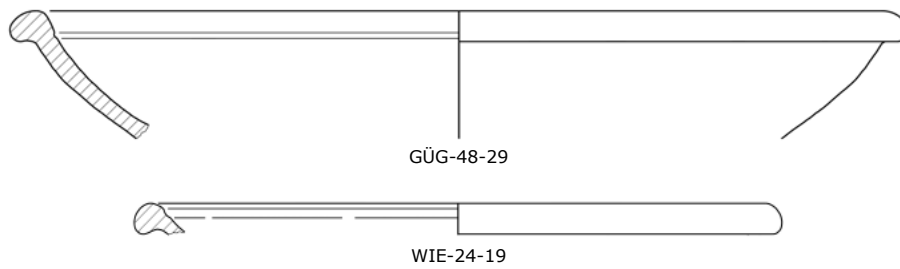

Pf. N2 TN: Schüssel mit gekehltem Horizontalrand

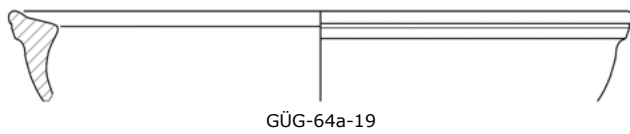

He. N4 TN: Teller mit einbiegender Wand

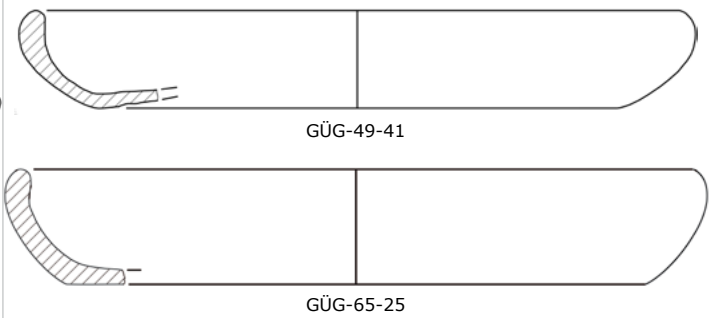

Pf. R12 TN: Teller mit Steilrand



Pf. R15a TN: Teller mit außen abgesetztem Rand

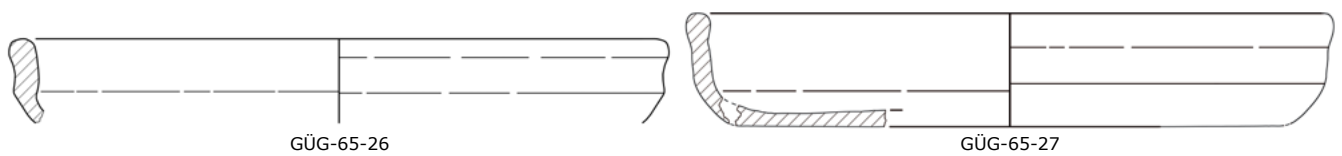

He. N2 TN: Topf mit einbiegender Wand und kurzem Rand

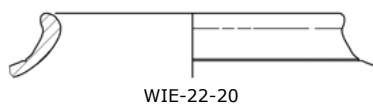

Hof. 120 TN: Flasche

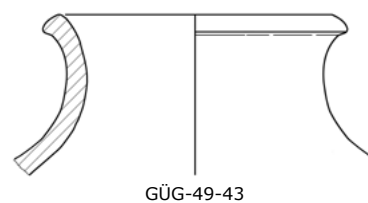

Ech. 1/2/4 FK: Becher mit Karniesrand

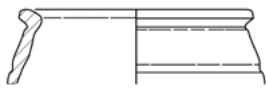

GÜG-64g-44



GÜG-51-98

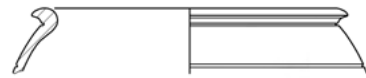

GÜG-64g-43



GÜG-48-33



GÜG-51-99

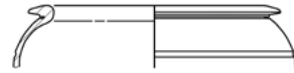

GÜG-64g-41

Ech. 3 FK: Becher mit hohem, geripptem Rand



GÜG-64g-48



GÜG-10-2



GÜG-49-44



GÜG-51-100

Nb. 30 FK: Becher mit Steilrand und Kerb-/Ratterdekor



GÜG-64a-20

Hof. 82/85 FK: Becher mit umgeschlagenem, gerilltem Rand



GÜG-65-31

Nb. 32/33 FK: Becher mit Steilrand und abgesetzter Schulter



GEM-1-319



GÜG-49-48

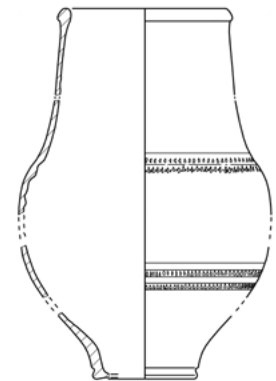

GÜG-65-32

Nb. 29 sim. FK: Becher mit umgeschlagenem Rand

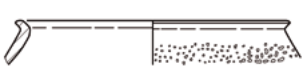

GÜG-42a-22



GÜG-64a-25



GÜG-51-102

Pf. F26 FK: Tongrundiger Becher mit ausschwingendem Rand



GÜG-29-91

Nb. 32/33 FK: Rheinischer/Trierer Spruchbecher

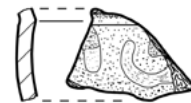

BAB-11-1

He. 14a GK: Zweihenkelkrug mit Halsring und verdicktem Rand

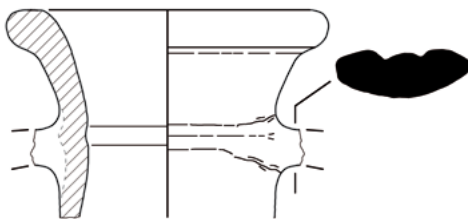

GÜG-29-92

Hof. 53 GK: Einhenkelkrug mit Halsring

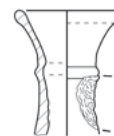

GÜG-48-35

Nb. 61 GK: Einhenkelkrug mit Kragenrand

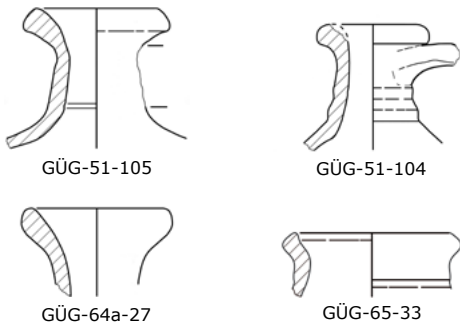

Nb. 62 GK: Einhenkelkrug mit trichterförmigem Hals und Randlippe

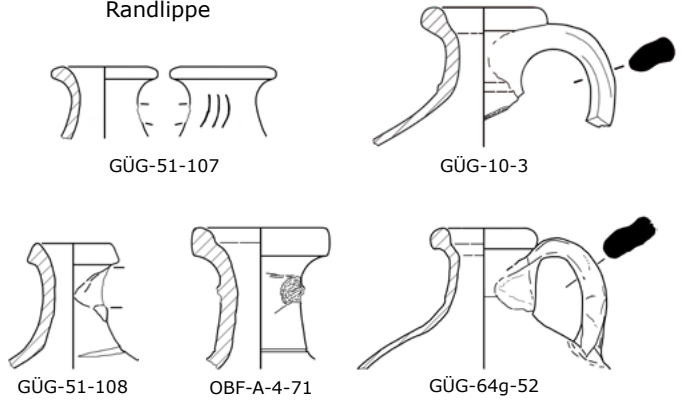

Nb. 63 GK: Krug mit scheibenförmigem Kragen und zylinderförmigem Hals

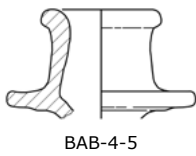

Nb. 65/69 GK: Zweihenkelkrug mit trichterförmigem Hals und verdickter Lippe

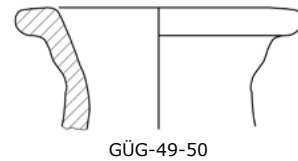

Nb. 68 GK: Zweihenkelkrug mit Wulstlippe und innen gekehltem Rand

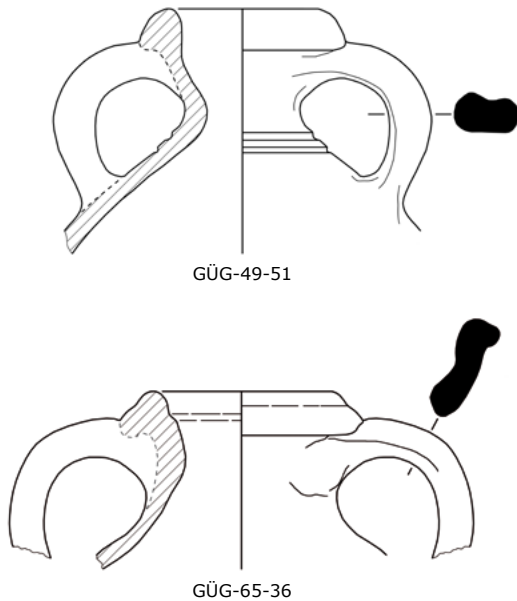

Nb. 73 GK: Mehrhenkelkrug mit leistenförmigem Rand oder geteilter Lippe

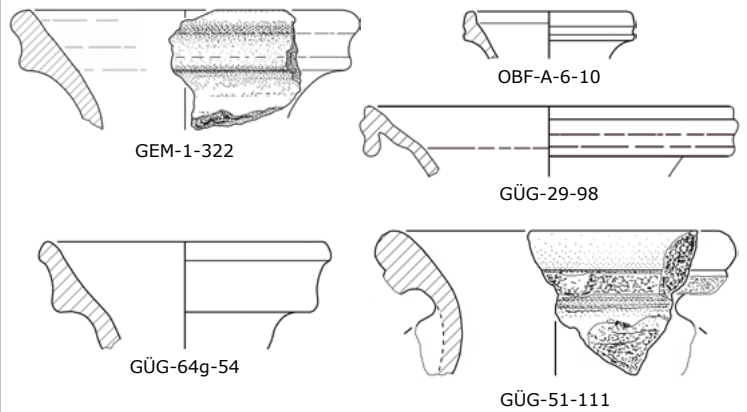

Pf. K2b GK: Einhenkelkrug mit kantiger Lippe



He. R1 Var. 1 GK: Teller mit einbiegender Wand

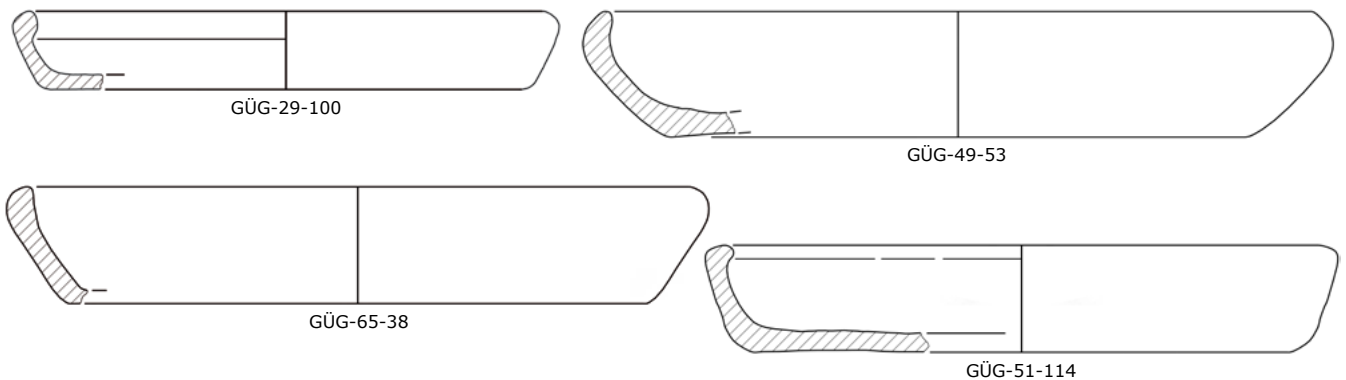

He. R1 Var. 2 GK: Teller mit einbiegender Wand

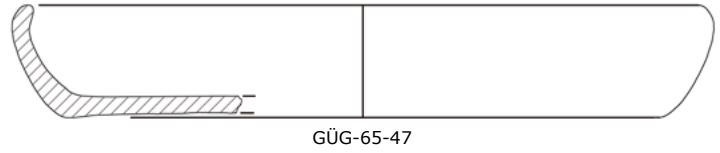
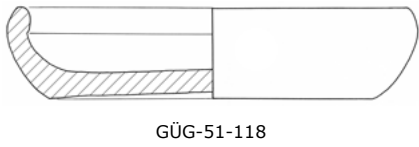
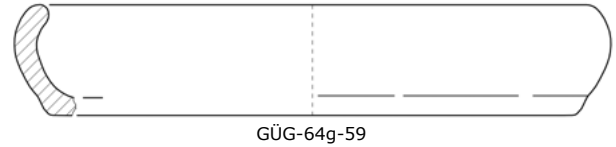
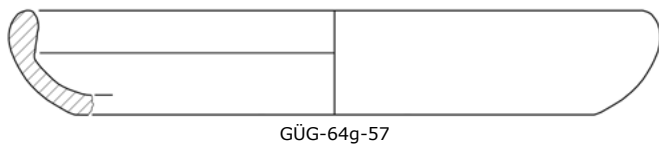

He. R2 GK: Teller mit einbiegender Wand und Riefe unter dem Rand

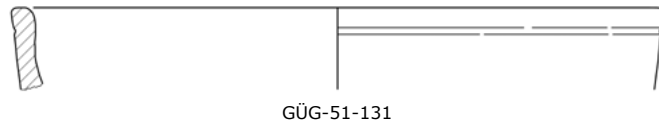
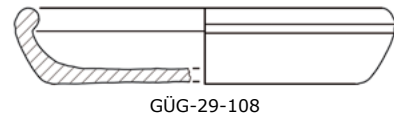
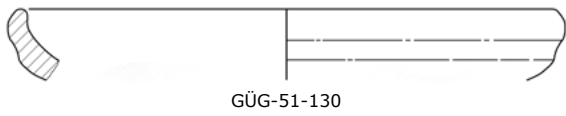

He. R2/3 GK: Teller mit oben und außen gerilltem Rand

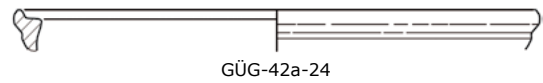
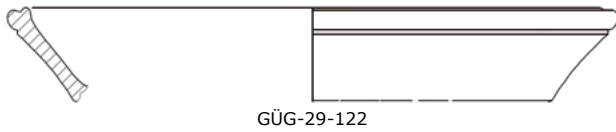

He. R3b GK: Teller mit Deckelfalz

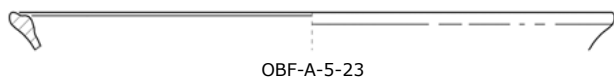

Nb. 112 sim. GK: Teller mit Schrägwand und innen profiliertem Rand

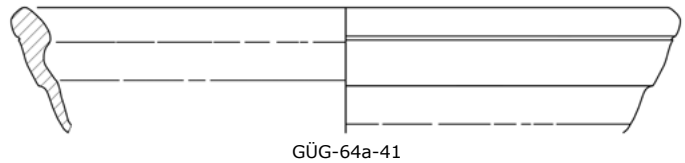

Nb. 113 sim. GK: Teller mit Steilrand

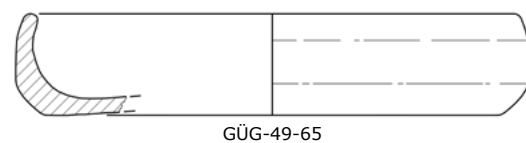
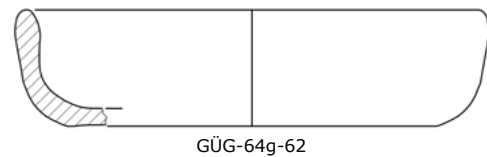

Pf. R15a GK: Teller mit ausgeprägter Schulter



GÜG-49-67



GÜG-49-69



GÜG-51-133

Pf. R15b GK: Teller mit außen abgesetztem Rand

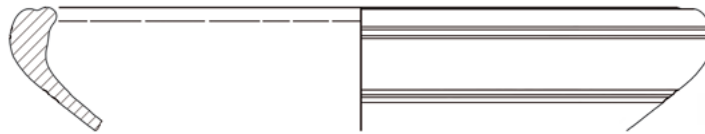

GÜG-29-113

He. 8g GK: Schüssel mit Horizontalrand



GÜG-41-2



GÜG-42a-25



GÜG-42b-11

Hof. 93 A/C GK: Schüssel mit einschwingendem Kolbenrand



GÜG-49-72

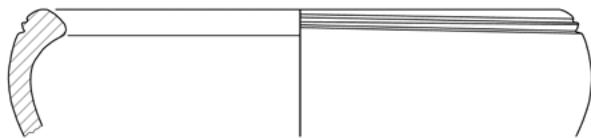

GÜG-49-74



GÜG-64a-45



WIE-25-29

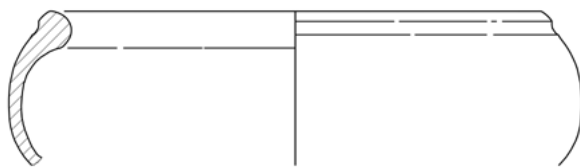

GÜG-49-70

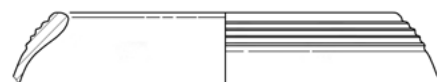

GÜG-51-135

Nb. 102 GK: Schüssel mit gerilltem Rand

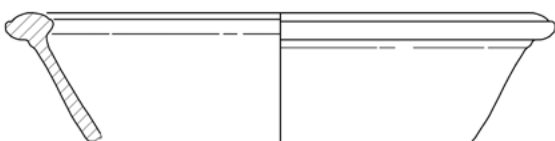

GÜG-12-4

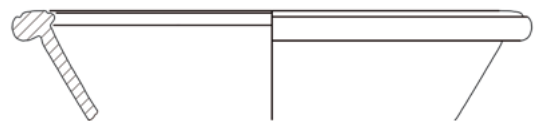

GÜG-29-123

Nb. 102 GK: Schüssel mit gerilltem Rand

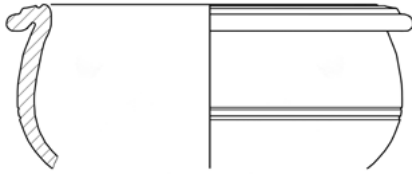

GÜG-51-141

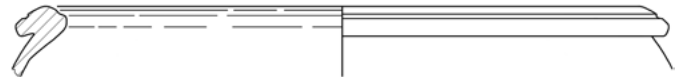

GÜG-51-148

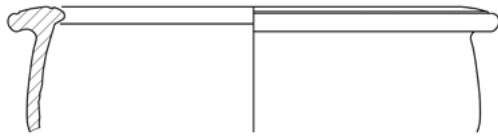

GÜG-64g-68

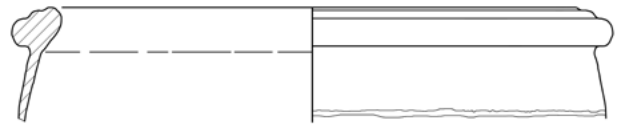

GÜG-42b-16

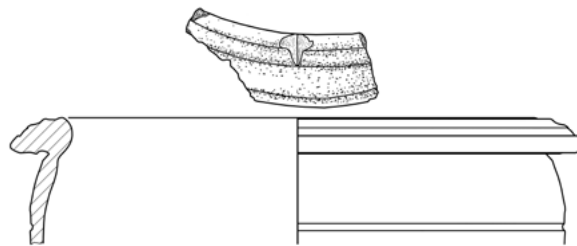

GÜG-49-77

Nb. 103 GK: Schüssel mit Deckelfalz

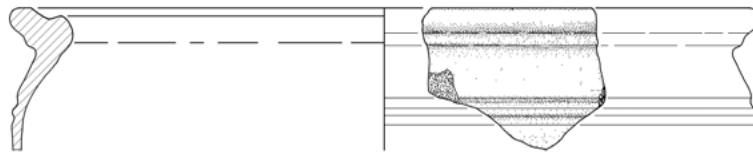

GEM-1-328



GÜG-64a-49



GÜG-42a-27

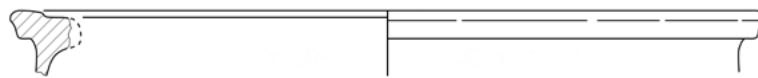

GÜG-51-153

Nb. 104 GK: Schüssel mit Kolbenrand

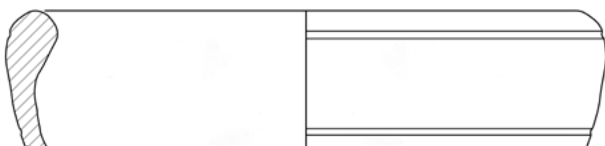

GÜG-51-154



GÜG-51-164



GÜG-49-83

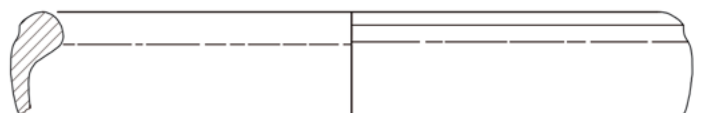

GÜG-42a-28

Nb. 105 GK: Schüssel mit einwärts geknicktem Rand

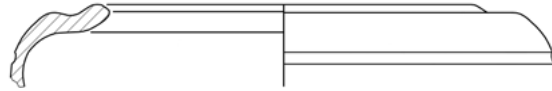

GÜG-64a-51

Nb. 87 GK: Topf mit Horizontalrand



GÜG-64a-52



GÜG-51-169

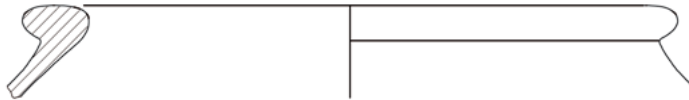

GÜG-10-4



GÜG-51-170

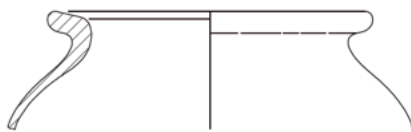

GÜG-11-6

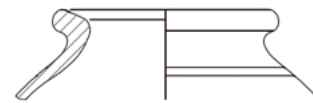

GÜG-29-135

Nb. 88 GK: Topf mit gerilltem Rand



GÜG-51-175



GÜG-29-138

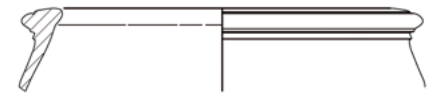

GÜG-65-60

Nb. 89 GK: Topf mit Deckelfalz



GÜG-49-90



GÜG-51-179

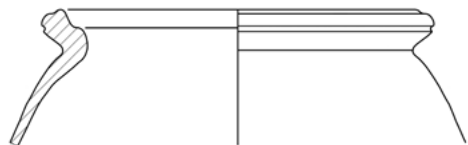

GÜG-64g-72

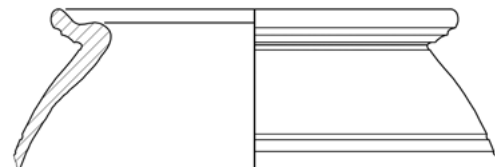

GÜG-49-86



GÜG-51-190

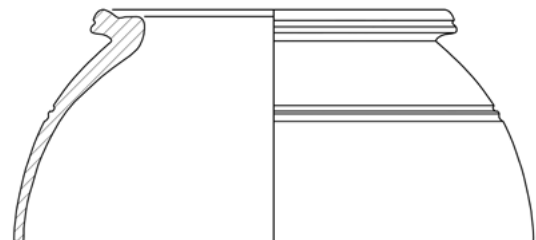

GÜG-49-89

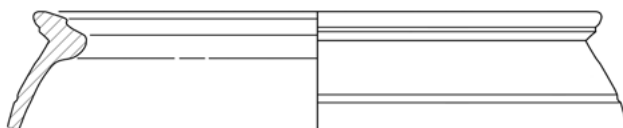

GÜG-51-176

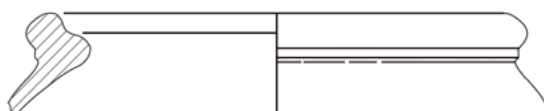

GÜG-65-56

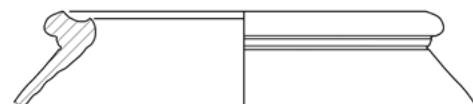

GÜG-65-57

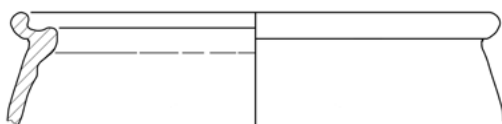

GÜG-51-180

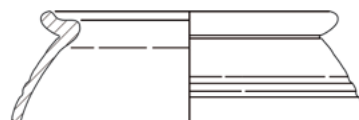

GÜG-65-61



GÜG-65-62

Pf. R47 GK: Honigtopf

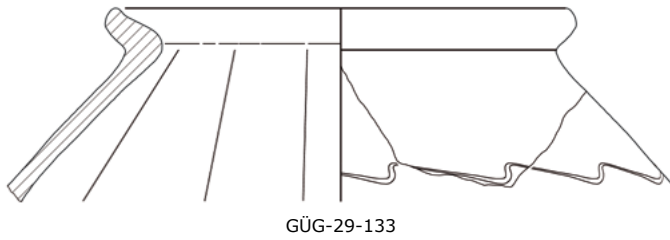

Pf. R49 GK: Räucherkelch

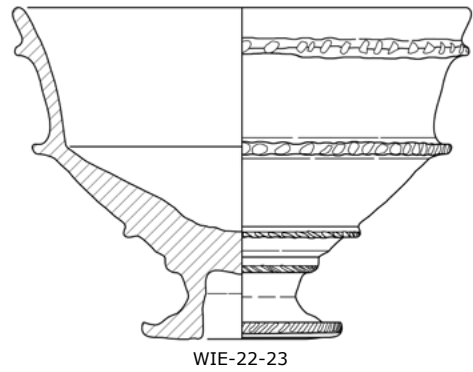
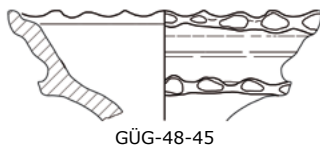
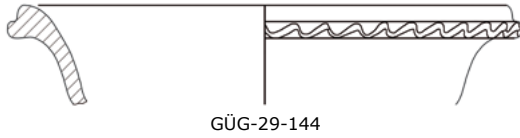

Pf. R48 GK: Deckel

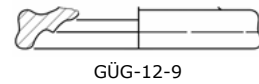

Pf. S1 Var. 1 SK: Rätische Reibschüssel mit geradem bis leicht gebogenem Kragen

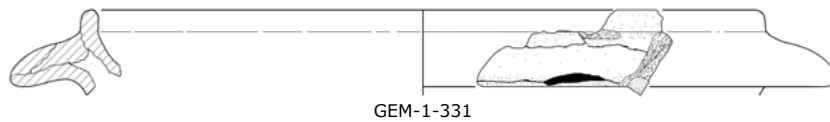

Pf. S1 Var. 2 SK: Rätische Reibschüssel mit gebogenem Kragen

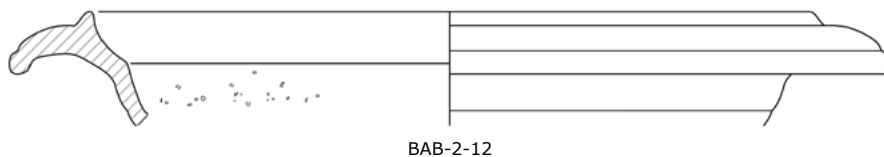

Pf. S1 Var. 2 SK: Rätische Reibschüssel mit gebogenem Kragen

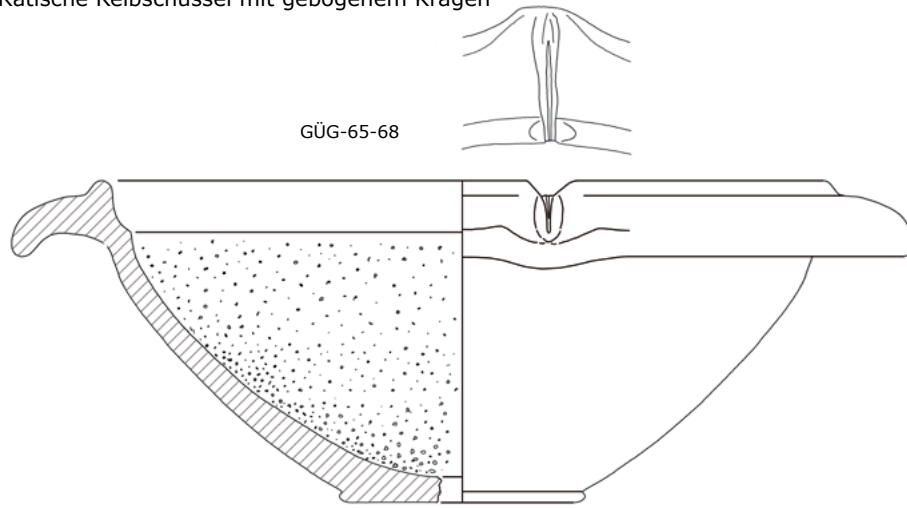

Pf. S3 SK: Reibschüssel mit Griffleiste

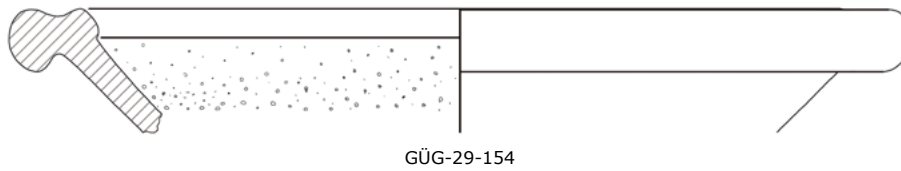

He. S1 SK: Reibschüssel mit abgesetzter Lippe

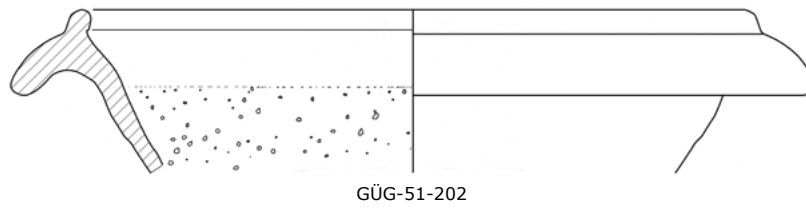

He. S2 SK: Reibschüssel mit gebogenem Kragen

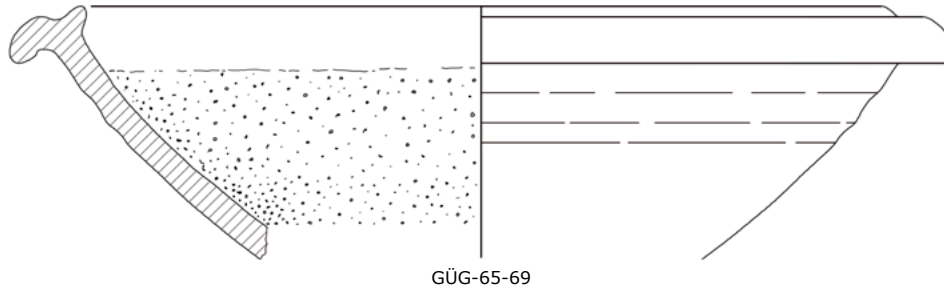

He. S4 SK: Reibschüssel mit hängendem Kragen

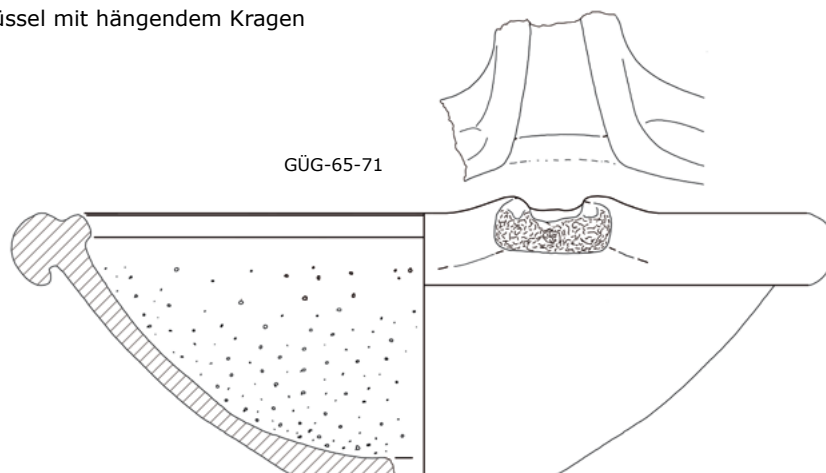

He. S6 SK: Reibschüssel mit Kragenrand

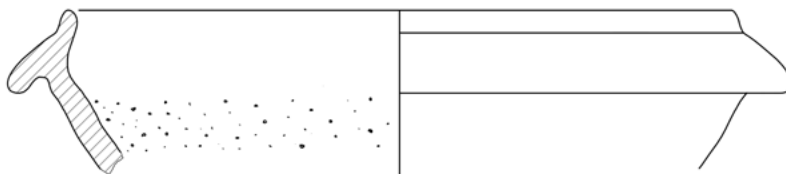

GÜG-49-101

Dres. 20 SK: Amphora mit dreieckig verdickter Lippe und Rundstabhenkel

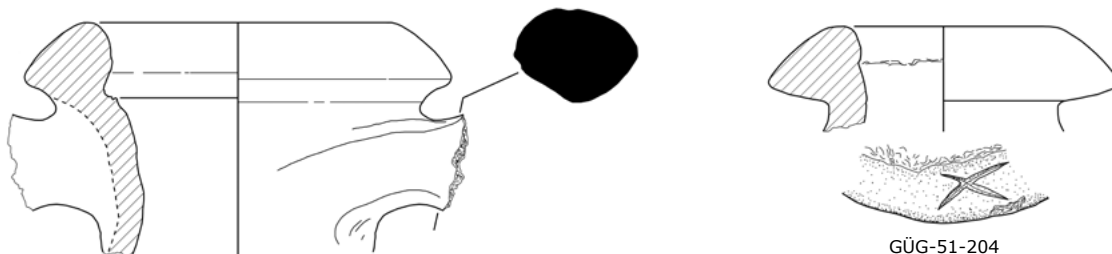

GÜG-49-102

GÜG-51-204

Nb. 74 SK: Amphora mit breiter Lippe oder dreieckig verdickter Lippe und Bandhenkel

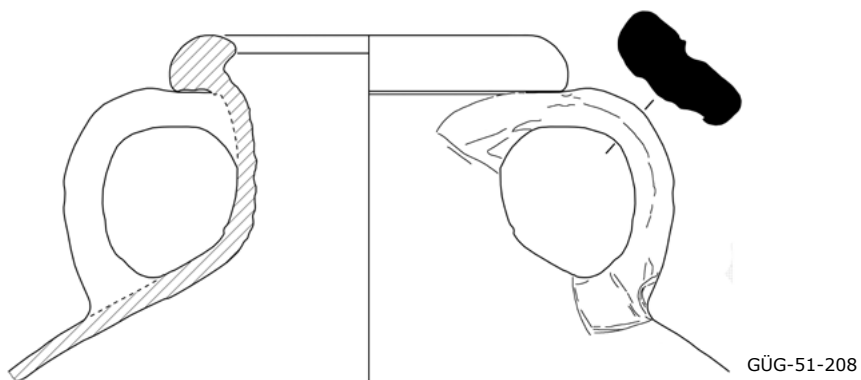

GÜG-51-208

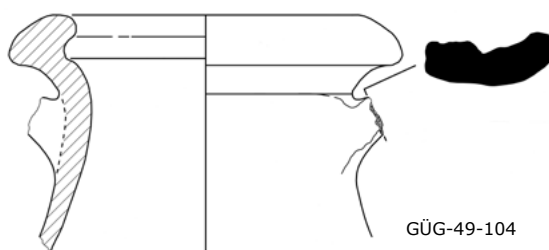

GÜG-49-104

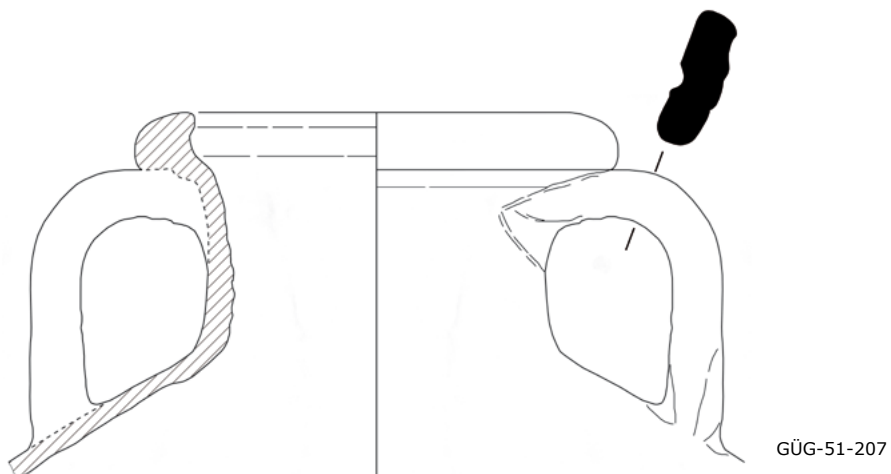

GÜG-51-207

Nb. 74 SK: Amphora mit breiter Lippe oder dreieckig verdickter Lippe und Bandhenkel

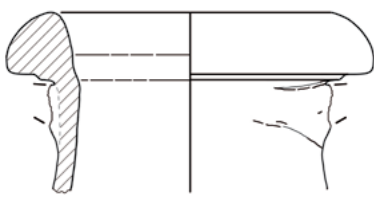

GÜG-29-150

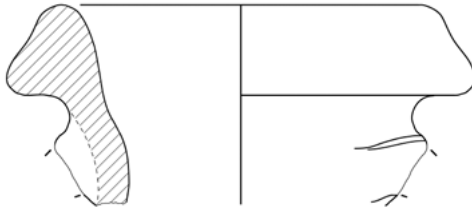

GÜG-65-74

SF: Kerzenhalter

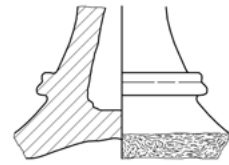

BAB-2-11

Ähnlich Mainz Typ 909

SF: Schüssel mit abgesetztem Steilrand



GÜG-65-51

Ähnlich Wimpfen 489

SF: Schüssel mit zylindrischem Bauch und ausbiegendem Rand

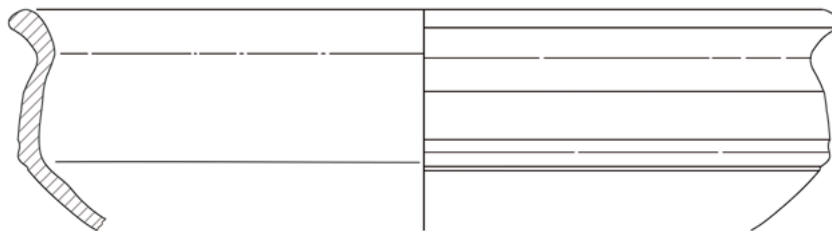

GÜG-65-53

FGP: Freigeformte Keramik provinzialrömischer Prägung

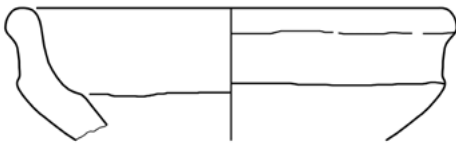

GÜG-64a-67

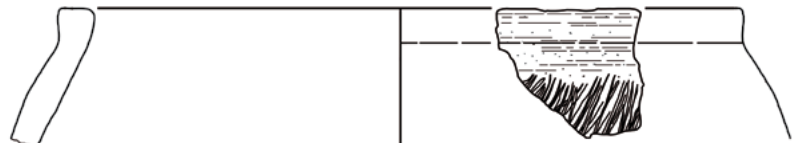

GÜG-42a-31

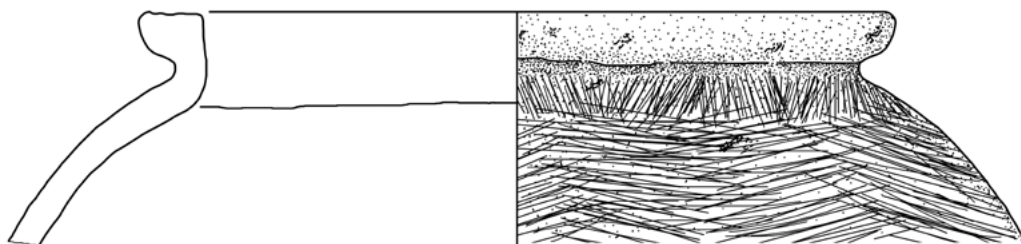

GÜG-46-2

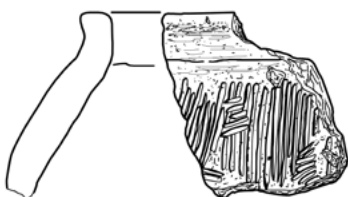

OBF-B-3

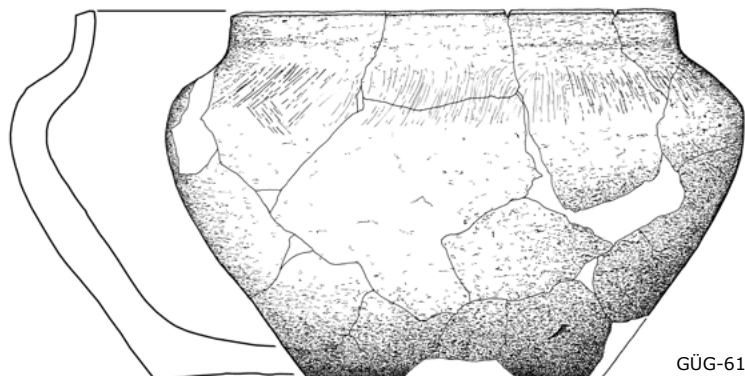

GÜG-61-1