

---

# Tafeln

## Bemerkungen zum Tafelteil

Die im Tafelteil abgebildeten Funde beruhen auf einer subjektiven Auswahl. Es wurden charakteristische Fundkomplexe ausgesucht, bei denen sich die Datierungskriterien nachvollziehen lassen, die einen repräsentativen Querschnitt des für die einzelnen Zeitperioden vorliegenden Fundmaterials geben und welche die inhaltlichen Aussagen verständlich machen (siehe Textteil, entsprechende chronologische Kapitel).

Die Fundkomplexe sind chronologisch geordnet. Innerhalb der gleichen Zeitstellung werden - wenn vorhanden - zunächst die Grabfunde, dann die Siedlungsfunde abgebildet.

Die hinter dem Fundort aufgeführte Nummer bezieht sich auf die Fundstellennummer im Katalog.

Die keramischen Funde sind im Maßstab M. 1:3, einige Bronzefunde im Maßstab M. 2:3 abgebildet.

---

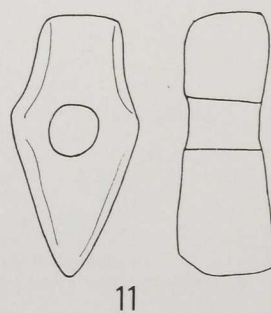
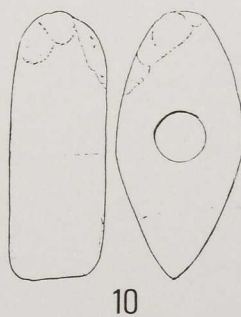
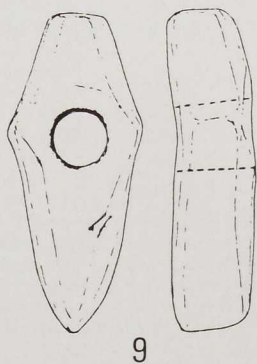
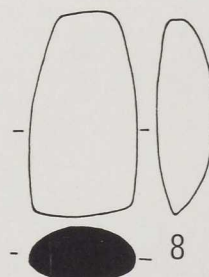
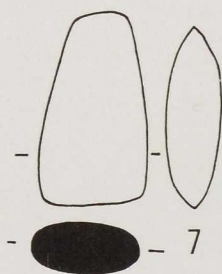
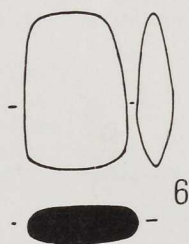
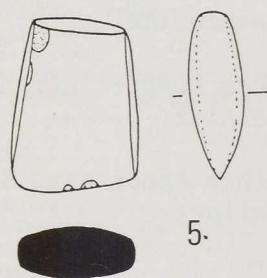
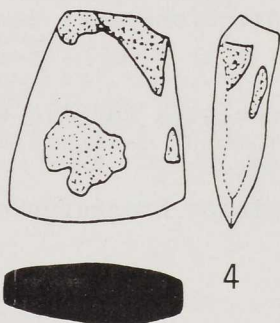
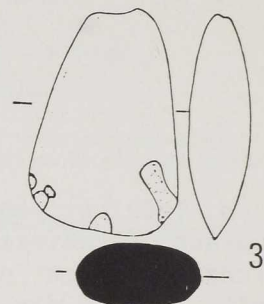
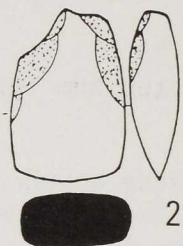
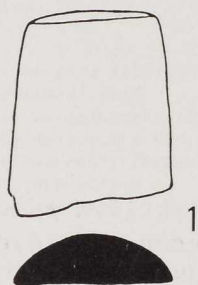

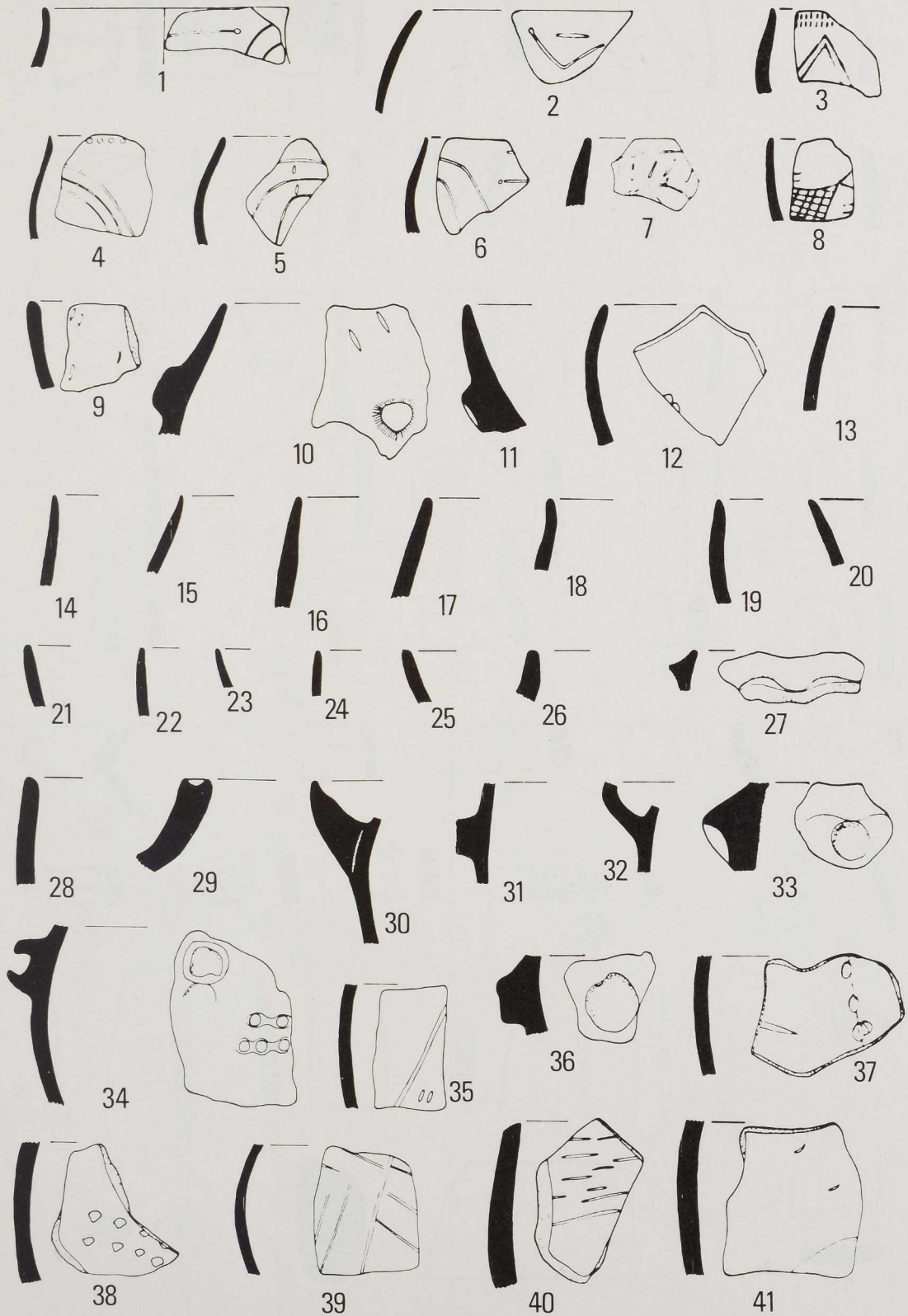

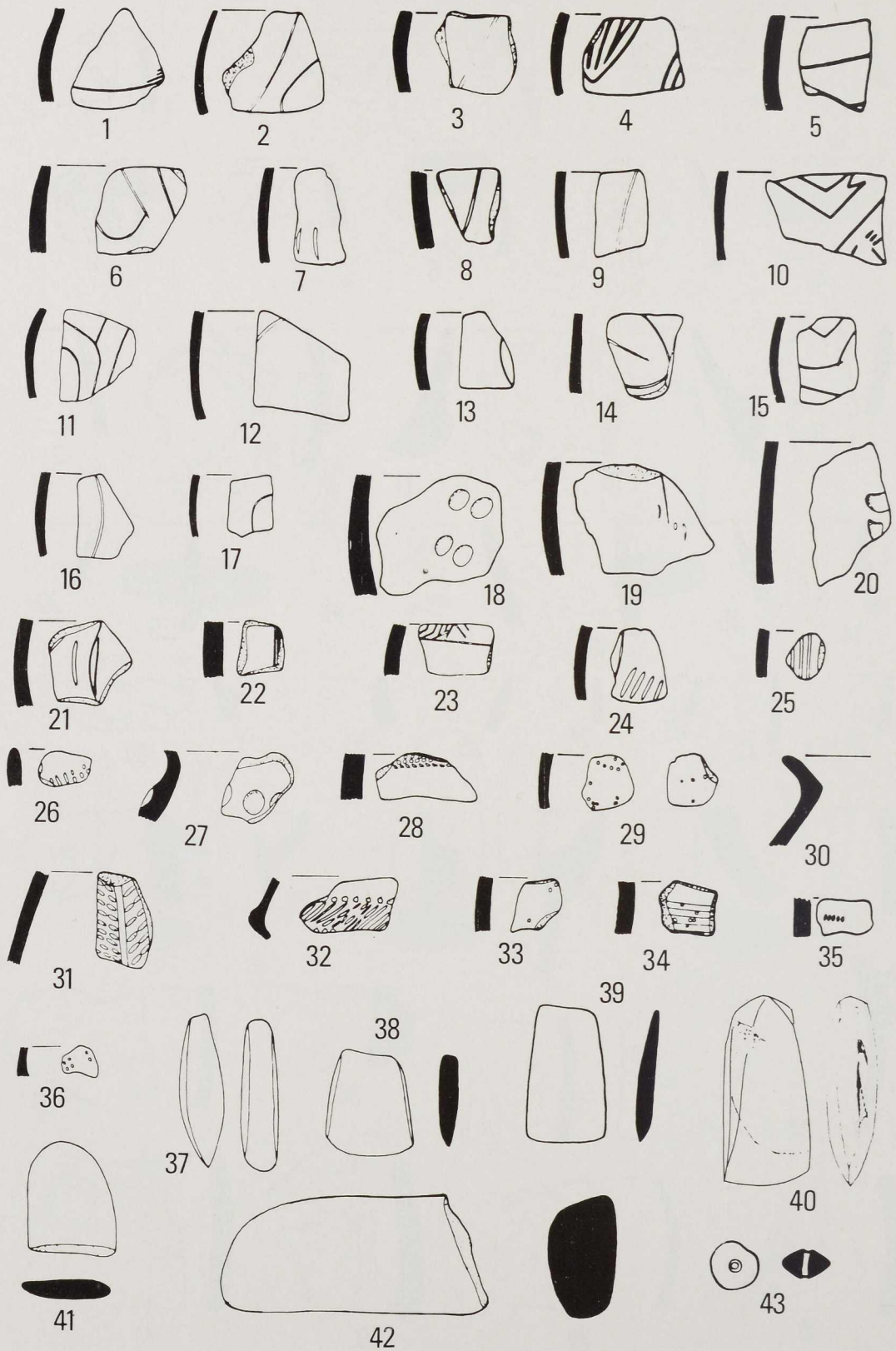

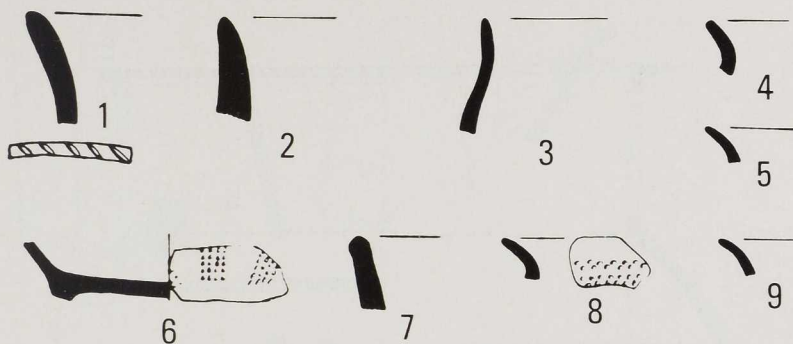

A

B

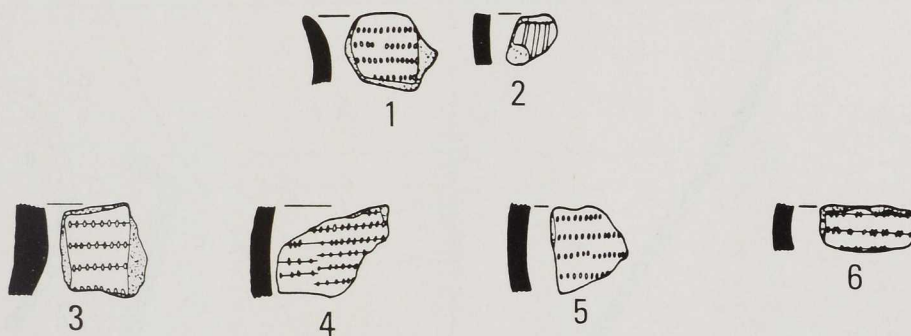

C

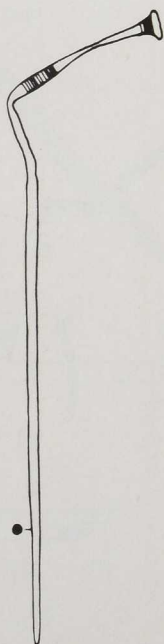

D

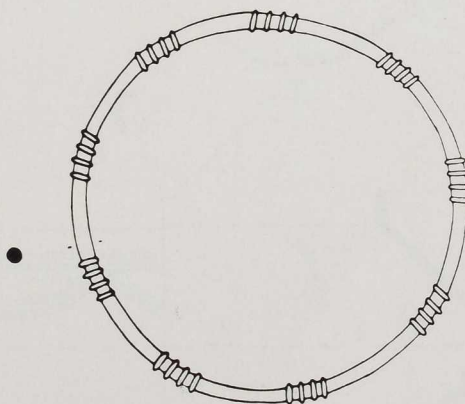

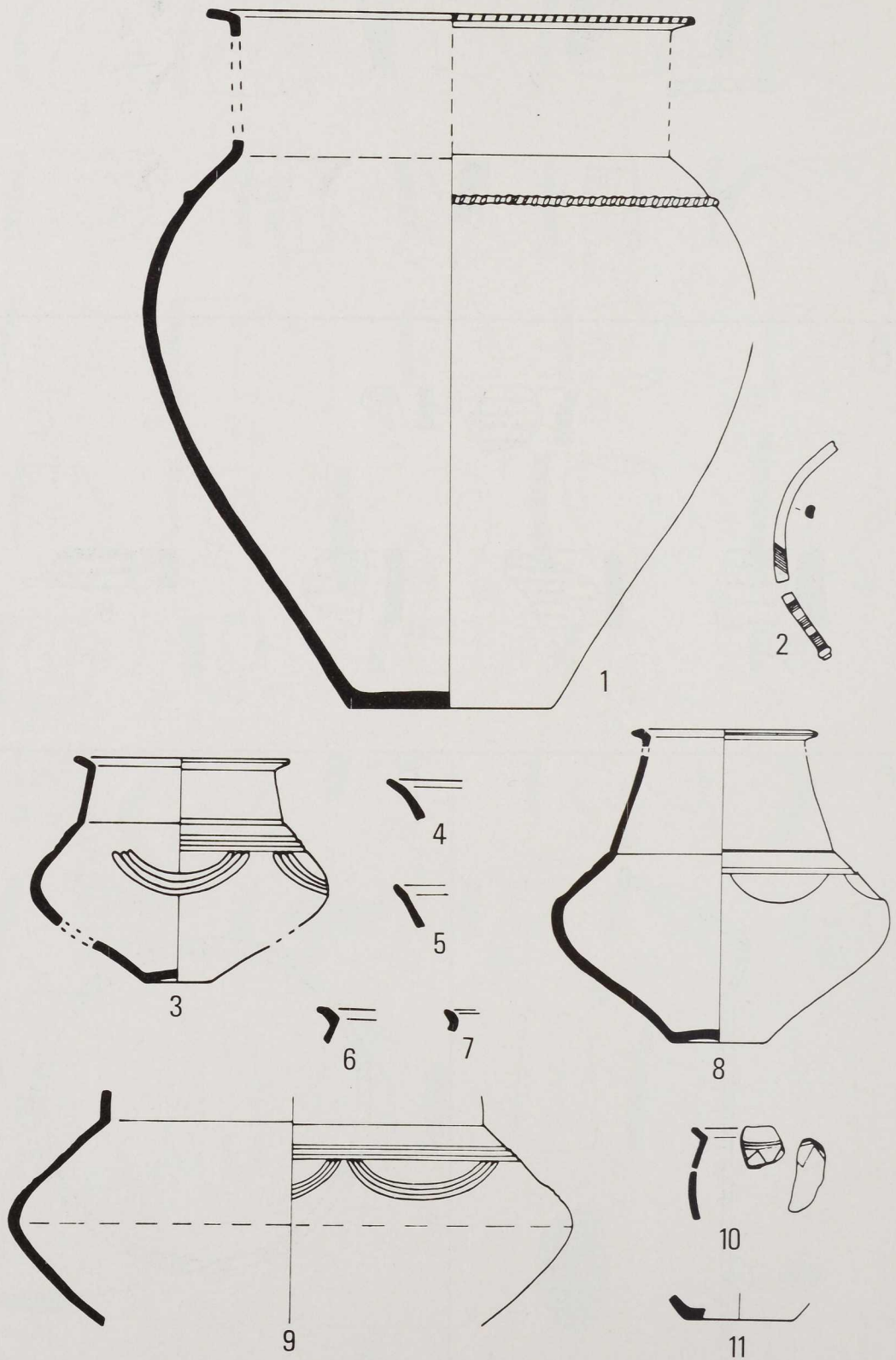

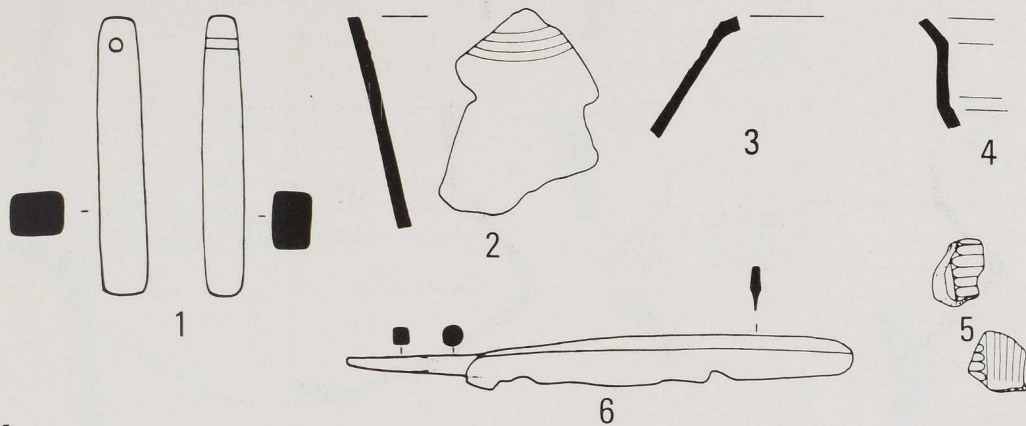

A

B

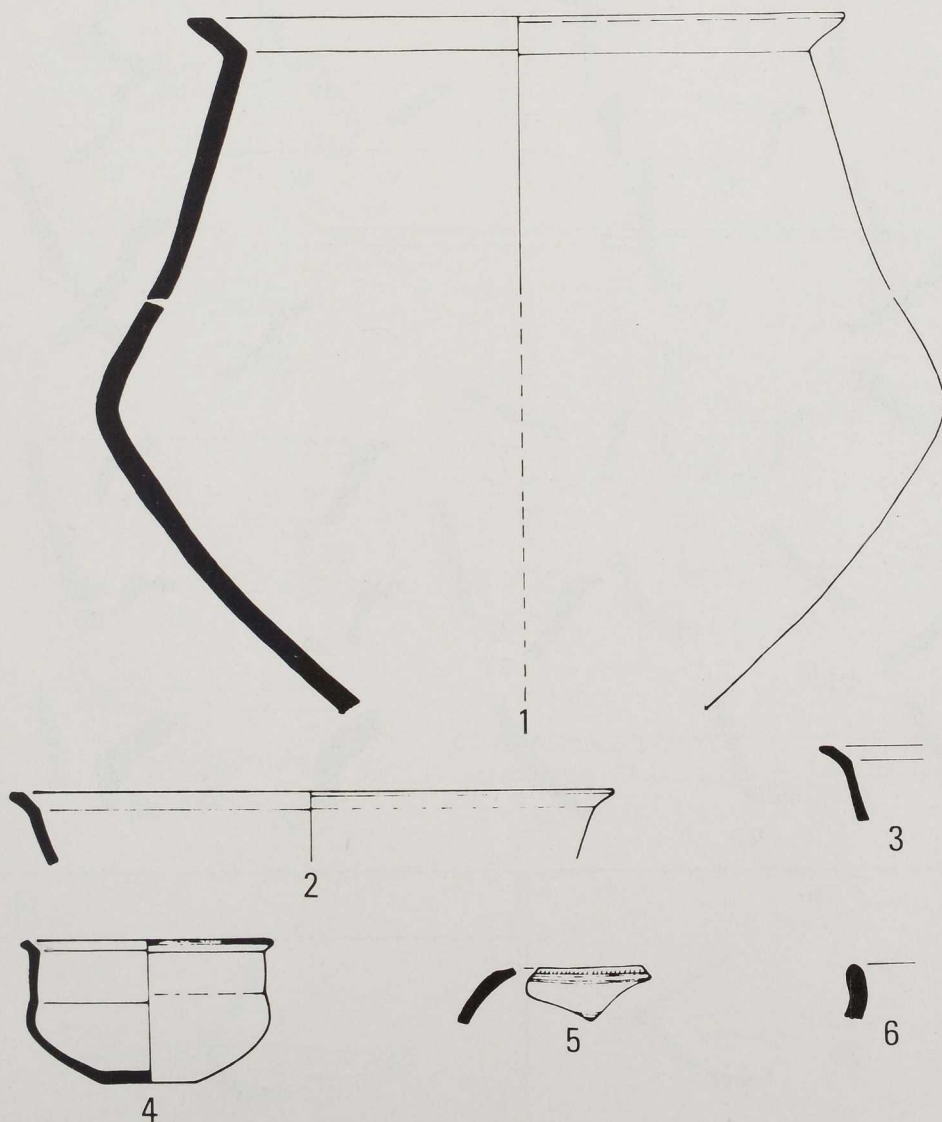

A Kleinseelheim (250). "Zollstock". Grab von 1975. 1,6 M. 2:3, 2-5 M. 1:3.  
 B Großseelheim (195). "Rotenberg". Grab von 1976. M. 1:3.

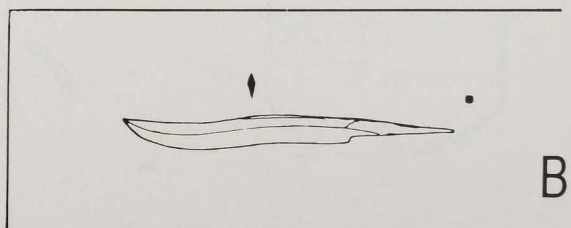
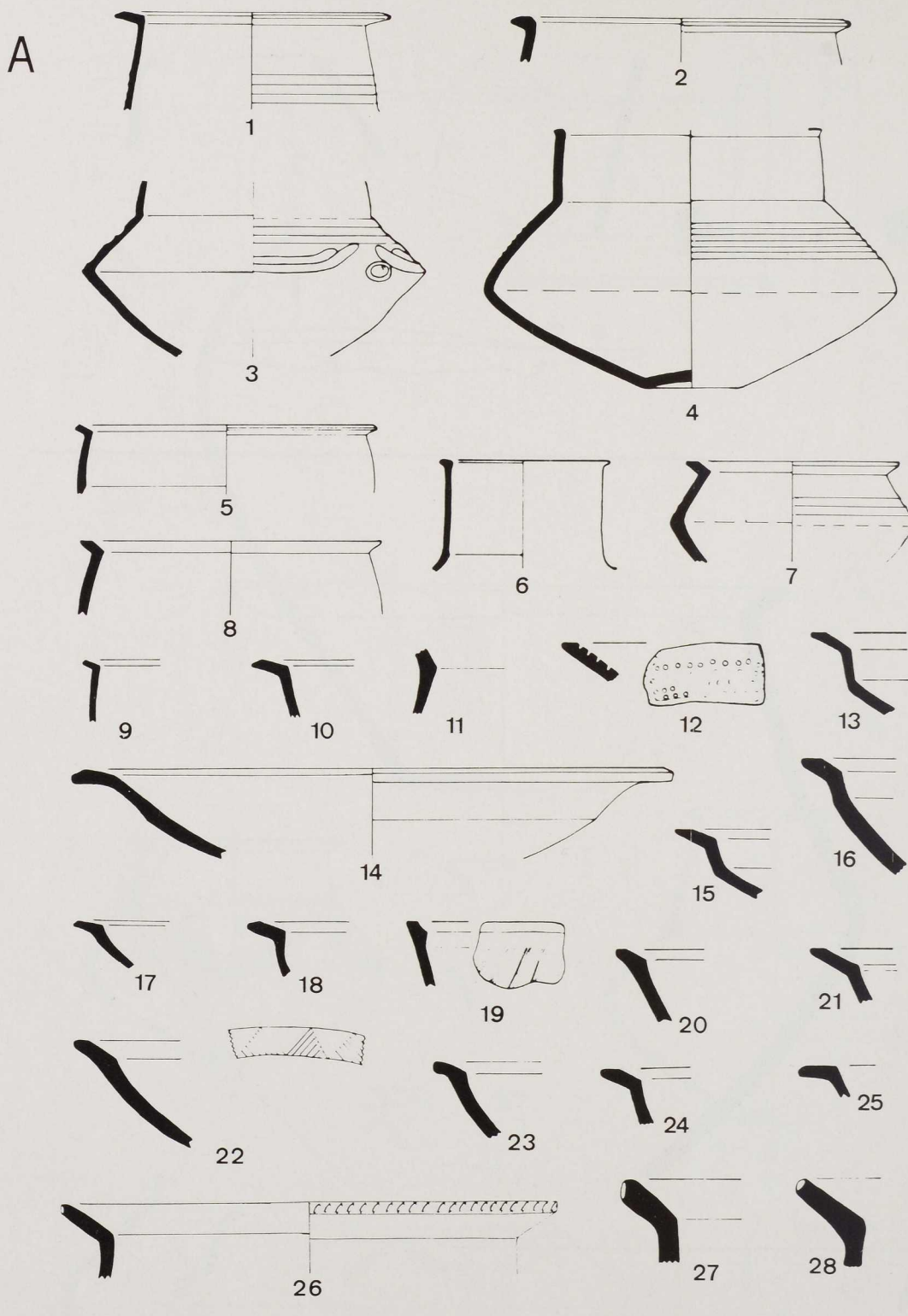

A Bauerbach (71). "Auf der kleinen Schänz". Grube 2.  
 B Mardorf (305). "Hinter der Hardt". Grube I/1951. M. 1:3.



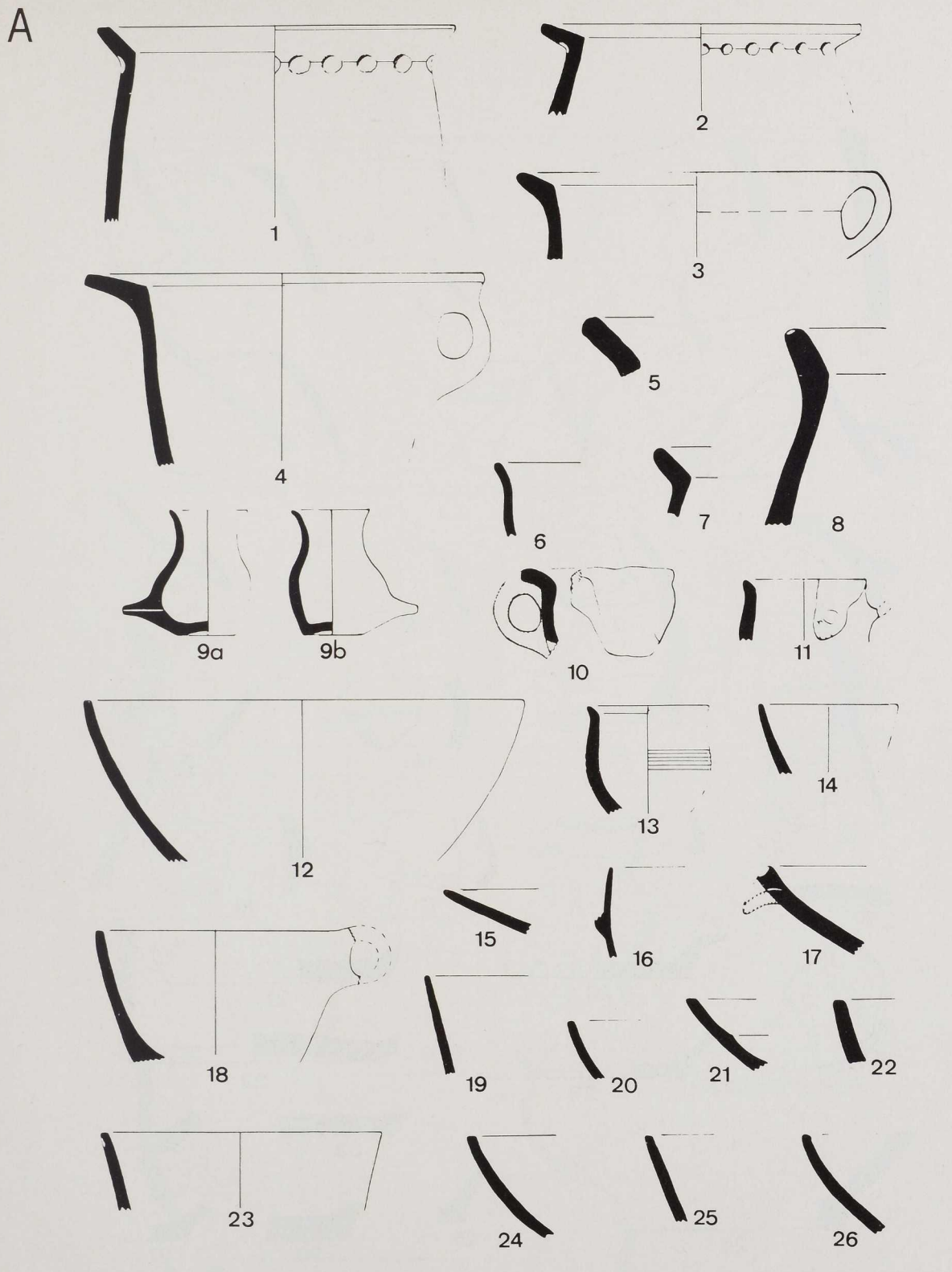

B

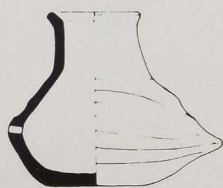

C



A Bauerbach (71). "Auf der kleinen Schänz." Grube 2. B Schröck ((402). "Auf der Schanze". Grube von 1955. C Mardorf (305). "Hinter der Hardt". Grube I/1951. M. 1:3.

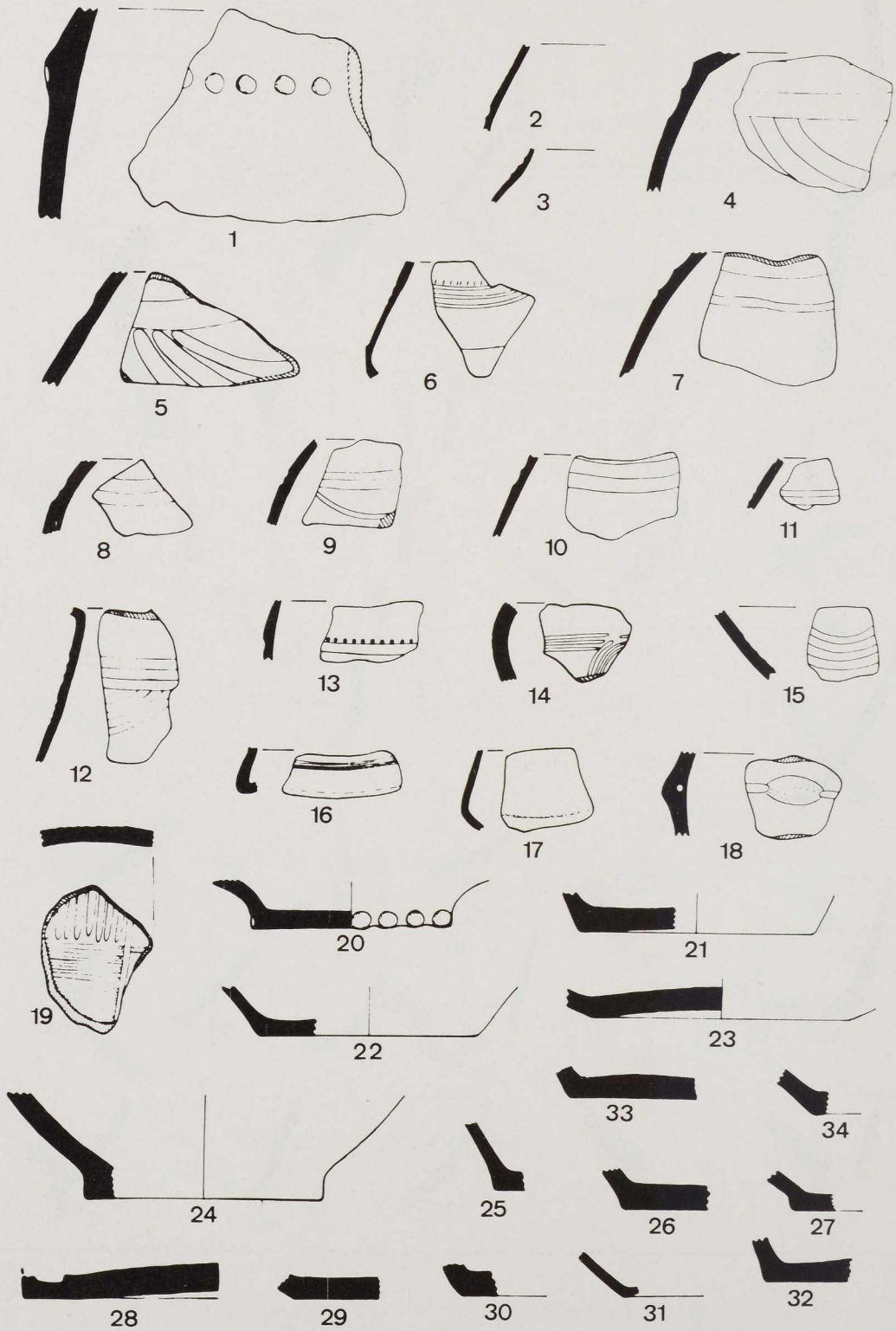

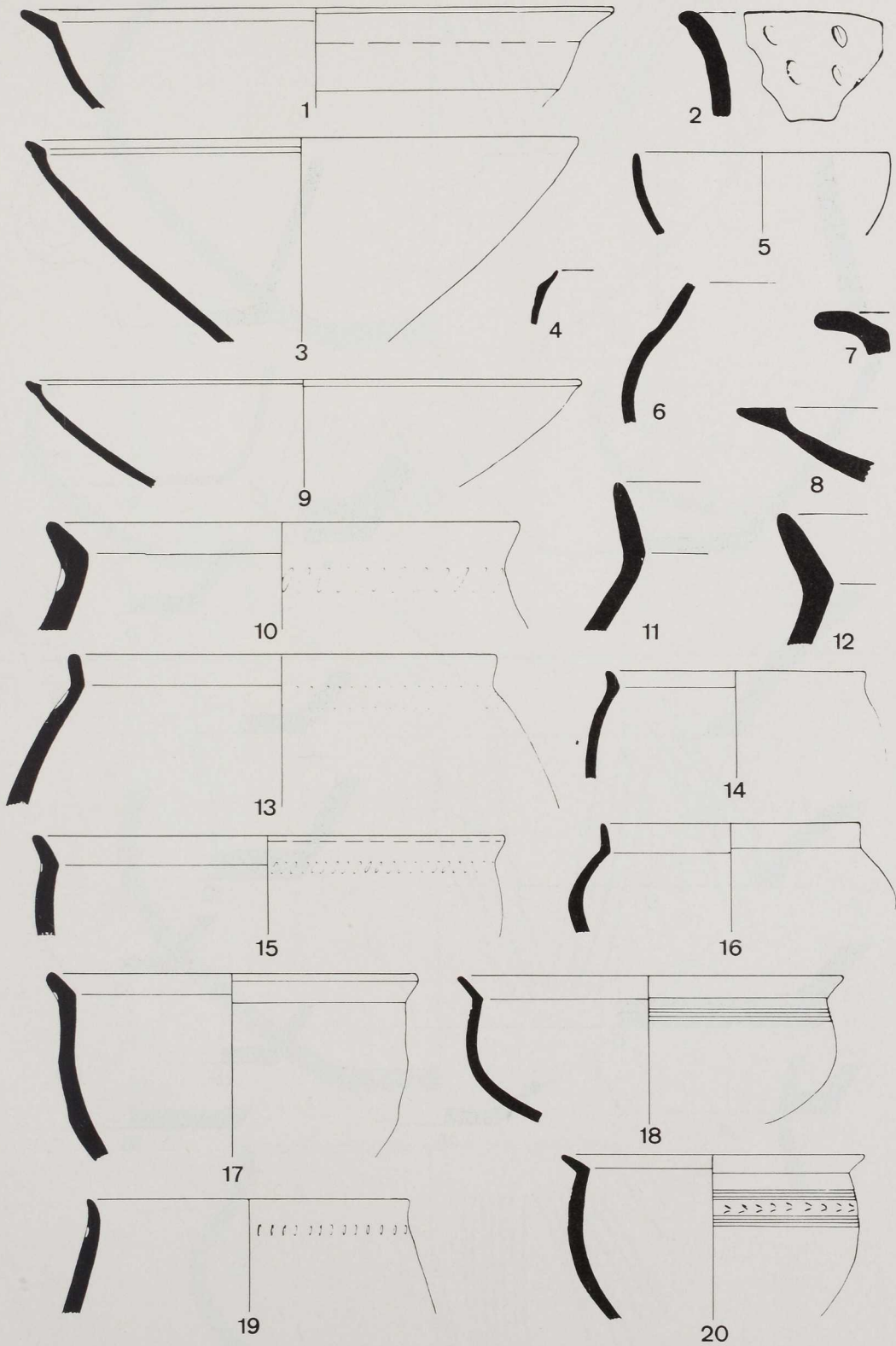



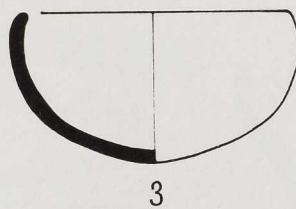
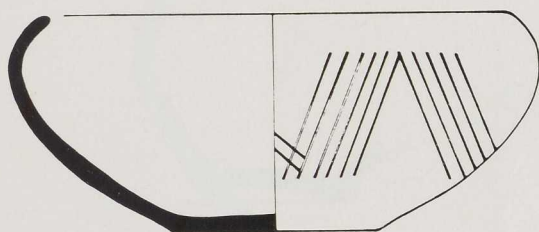
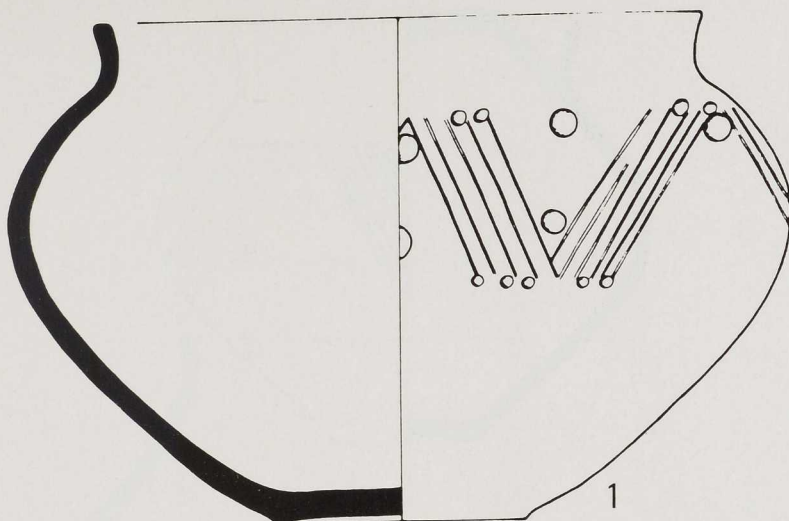

A

B

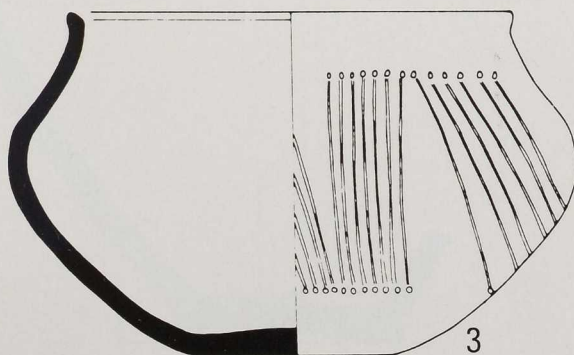
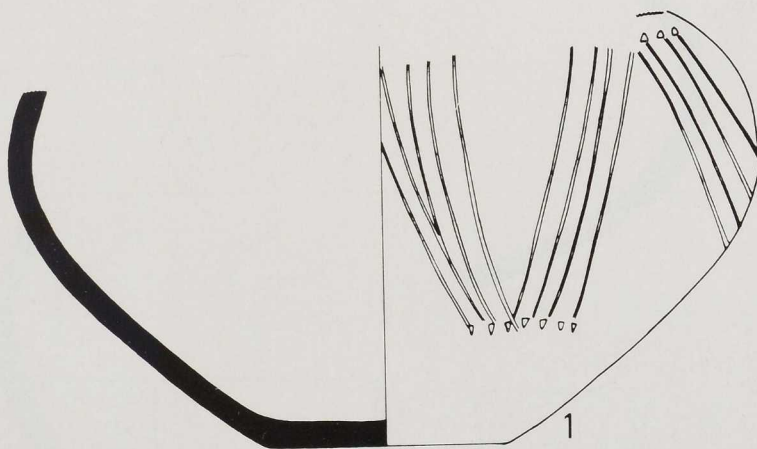

A Staatsforst Marburg (422). "Lichter Küppel". Hügel 13.  
 B Hassenhausen (230). "Interessentenwald". Hügel. M. 1:3.

A

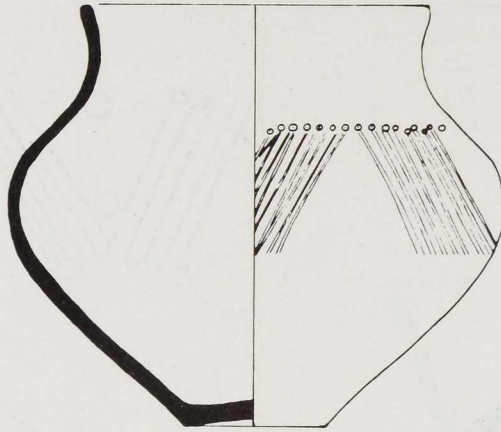

B

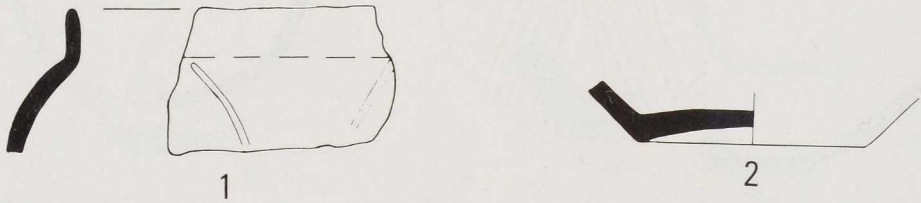

C

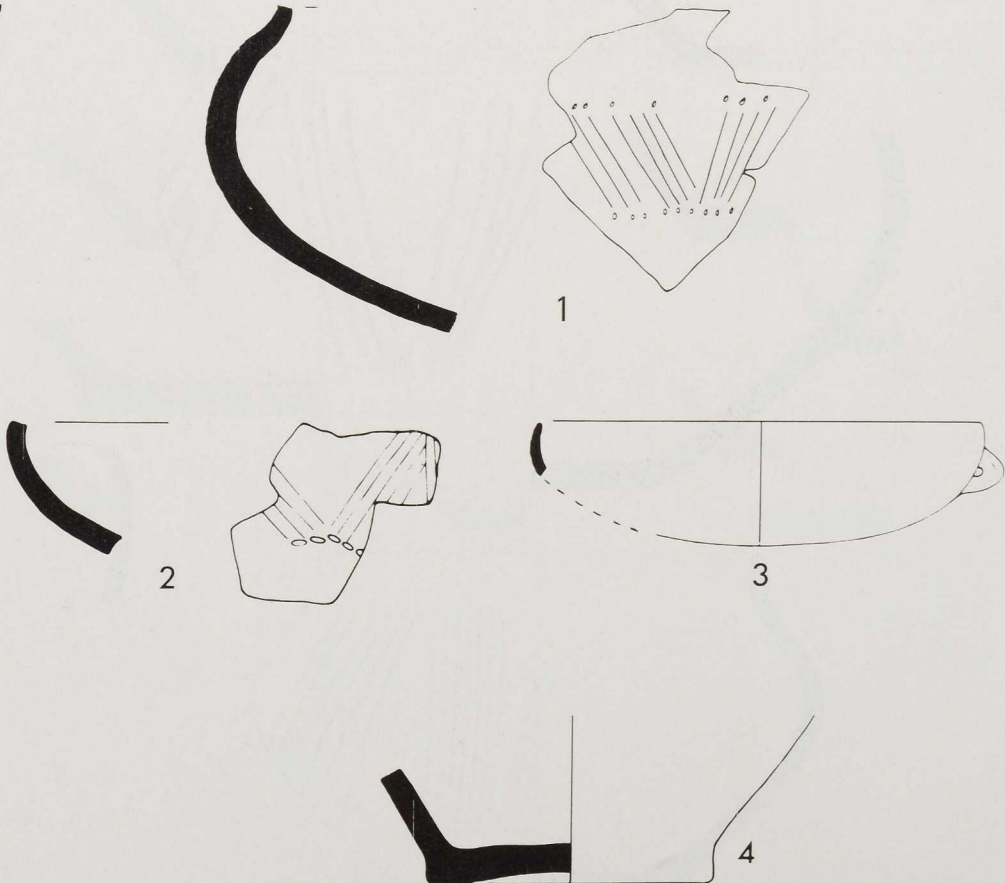

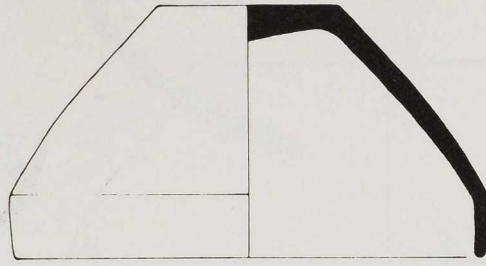

1

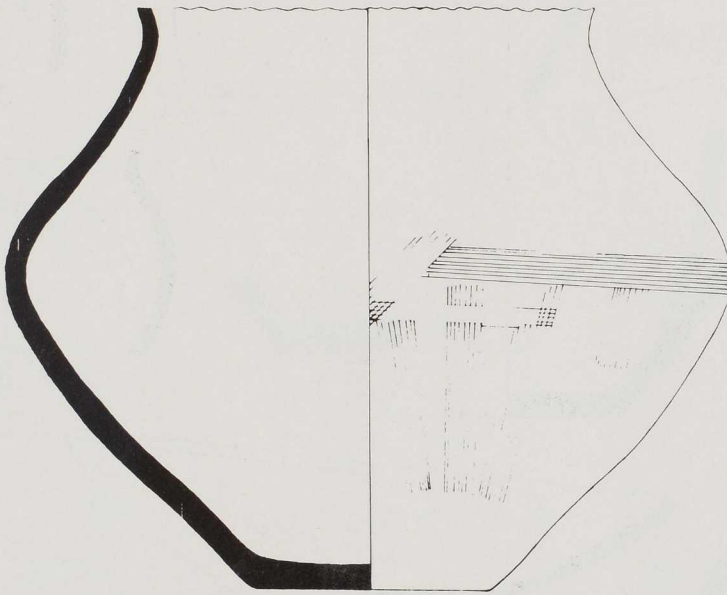

2

A

B

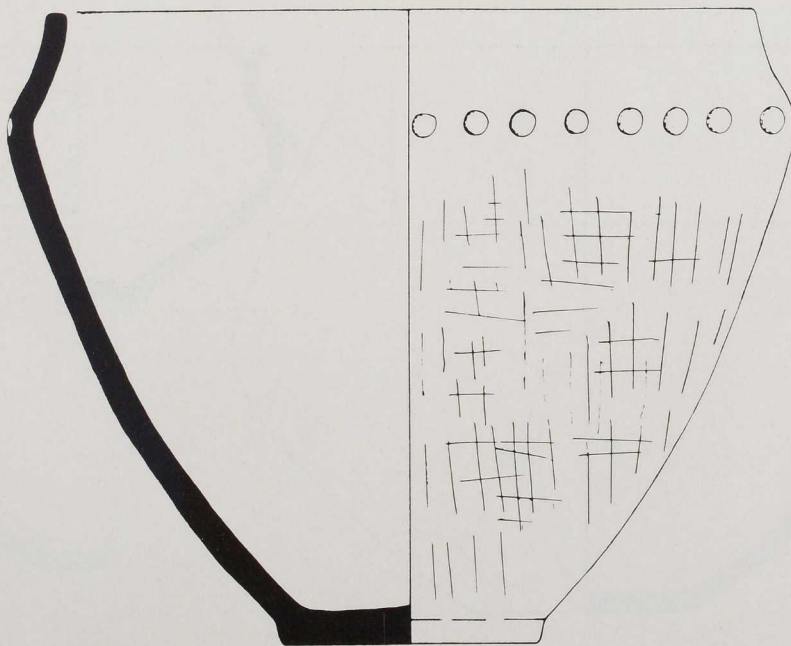

A Hachborn (213). "Heiligenwald". Hügel 2.  
B Amöneburg (49). "Brücker Wald". Hügel 32. M. 1:3.

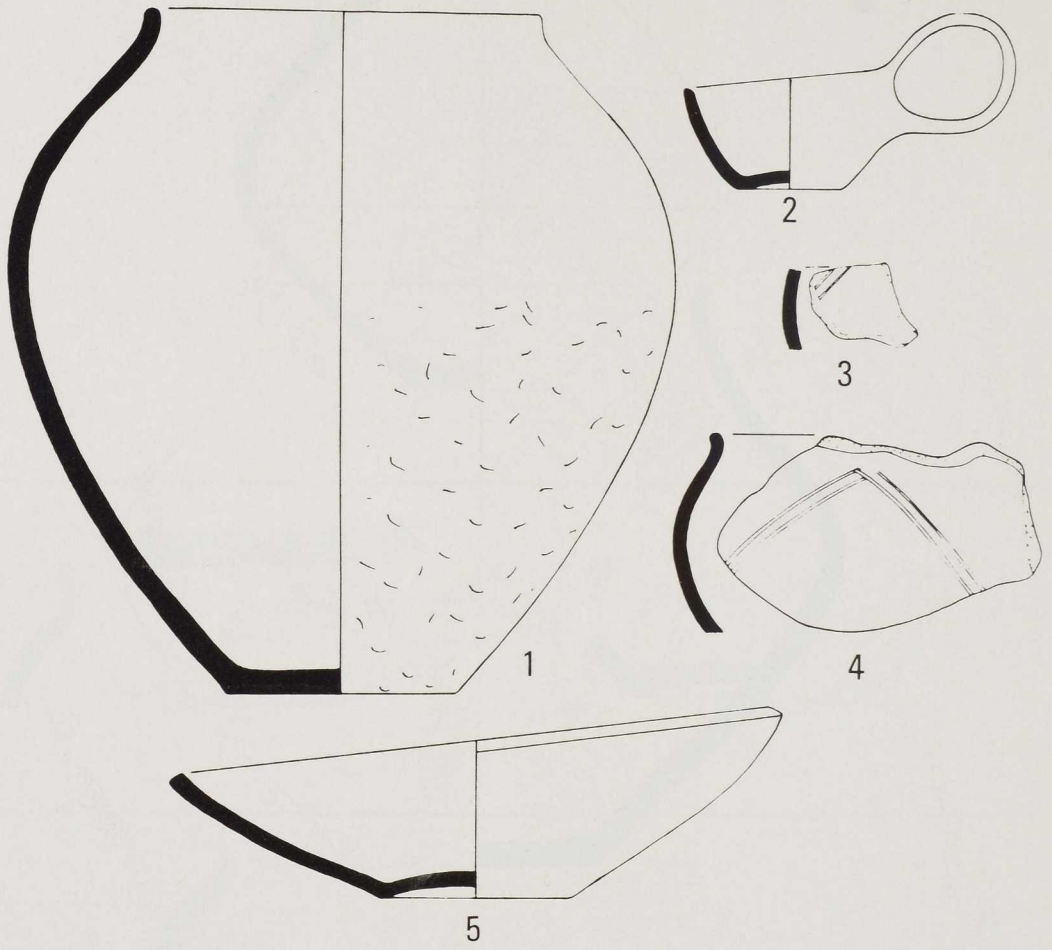

A

B

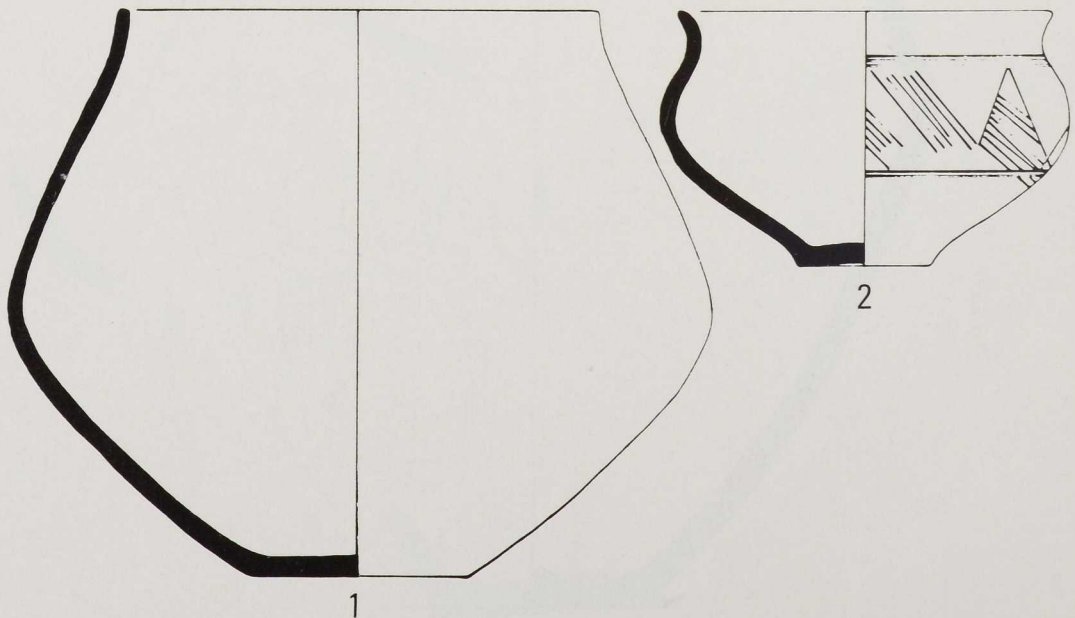

A Unterrospe (437). "Südhang der Höhe 235,1 m". Grab von 1934.  
 B Schönbach (379). "Hof Lauer". Grab 1/1931. M. 1:3.



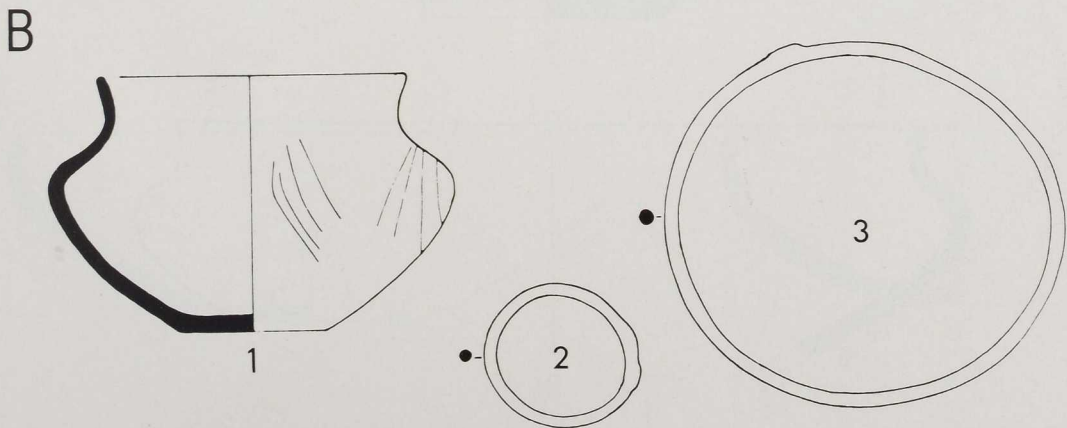
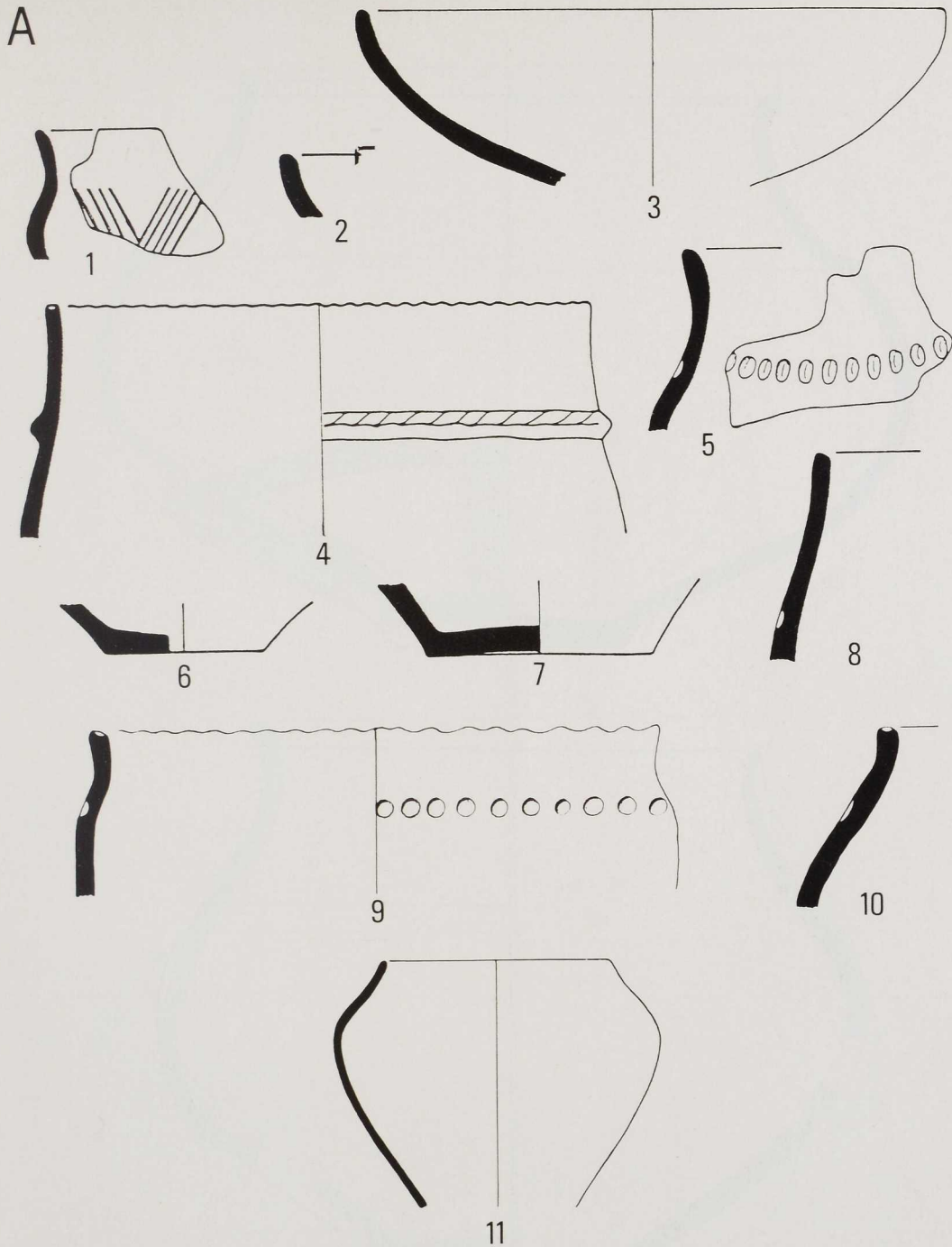

A Mardorf (306). "Hinter der Hardt". Grube IV/1951.  
 B Staatsforst Marburg (417). "Stempel". Hügel II. M. 1:3.

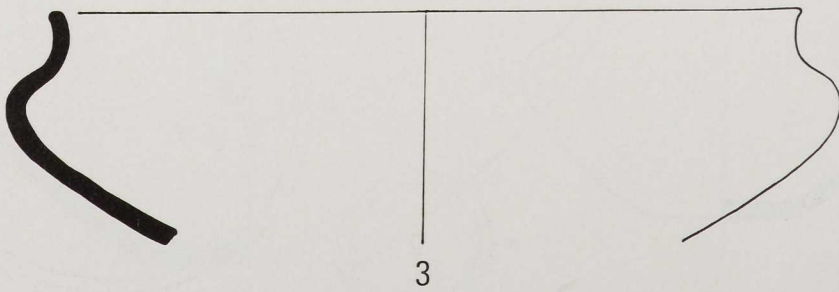
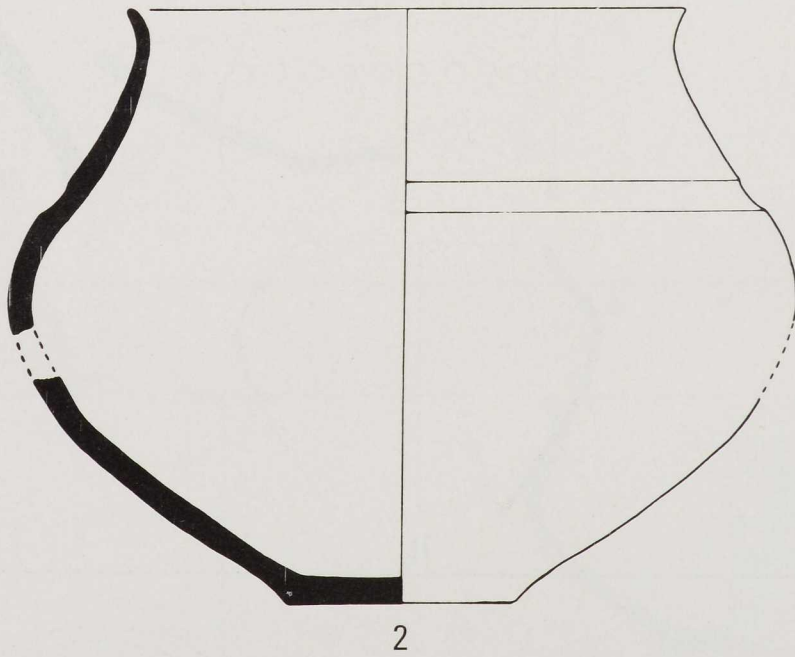
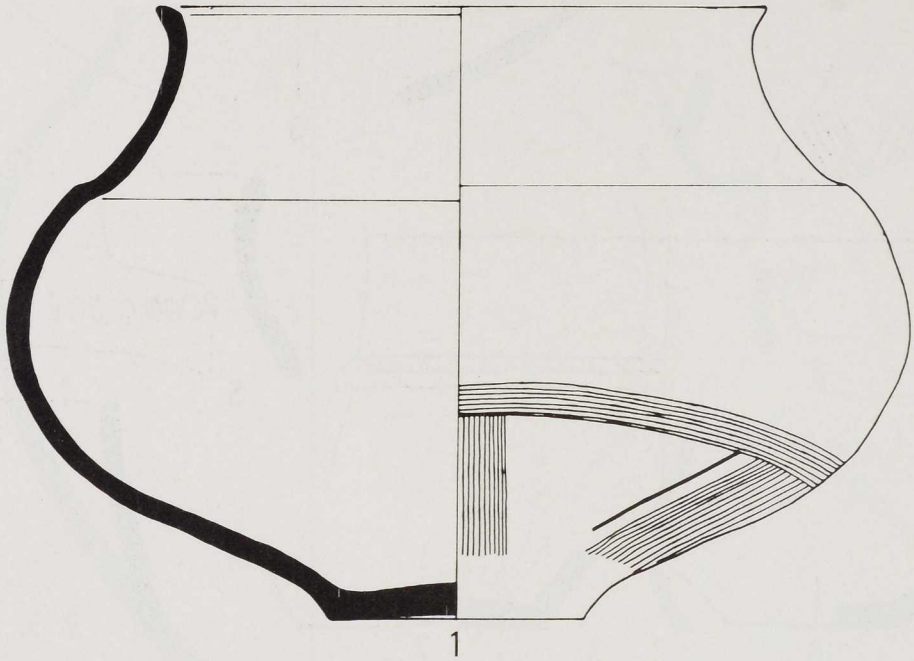

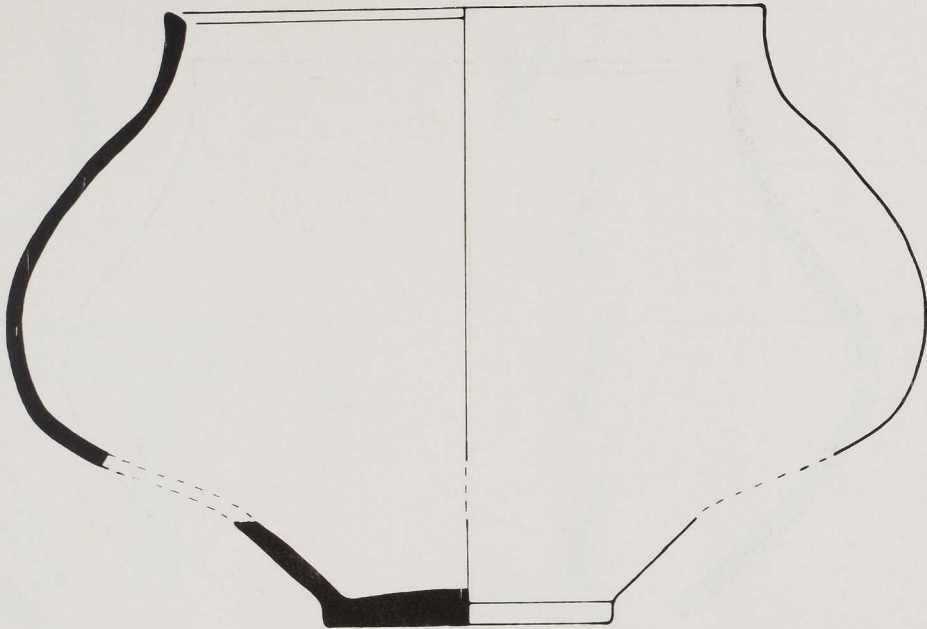

1

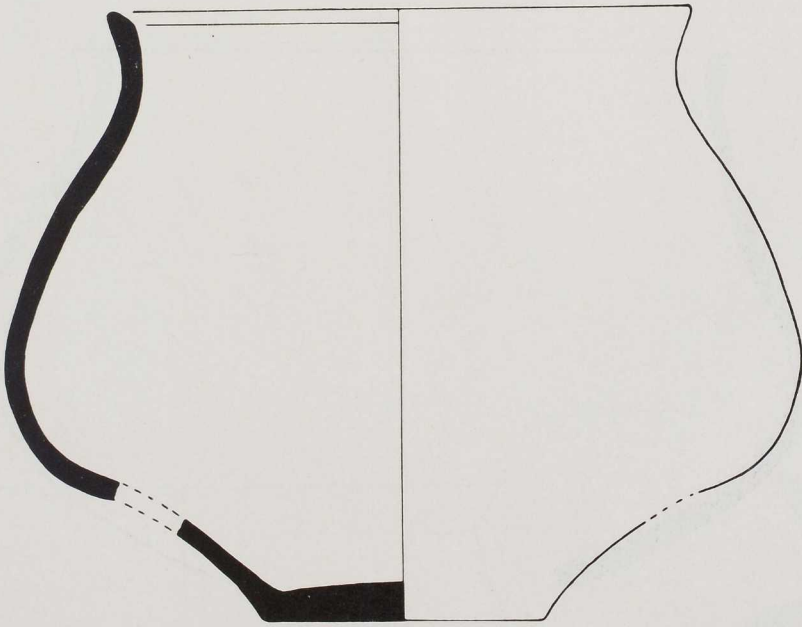

2

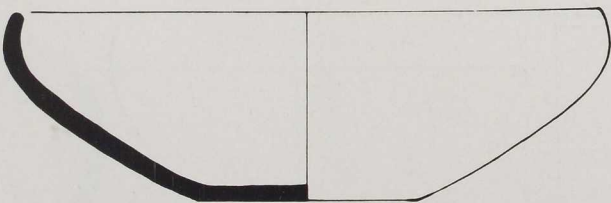

3

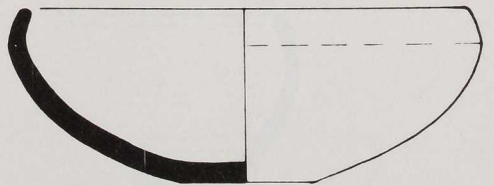

4

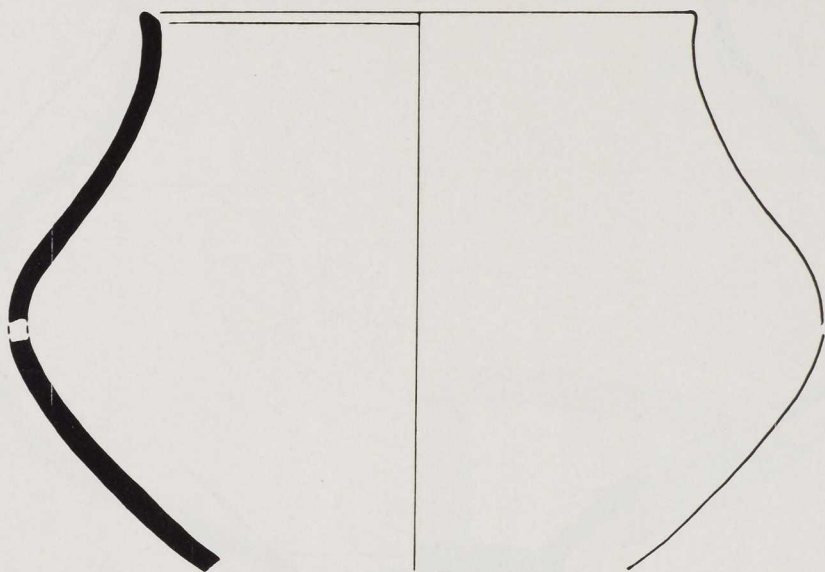

1



2

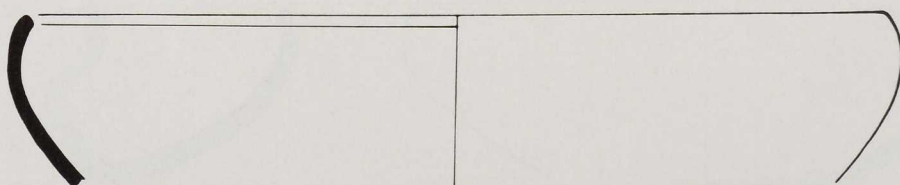

3

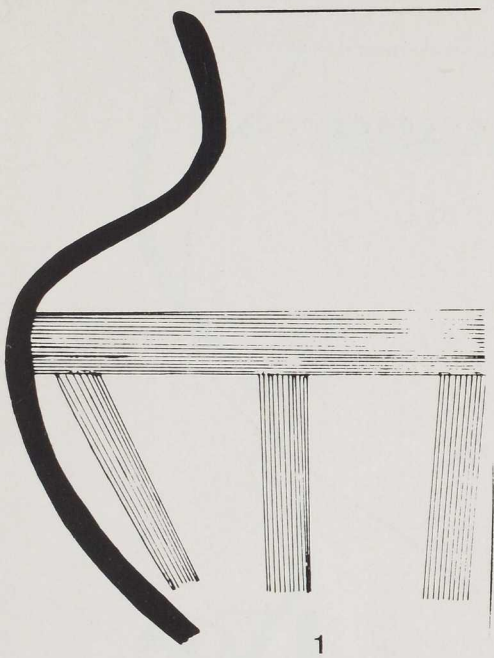

1

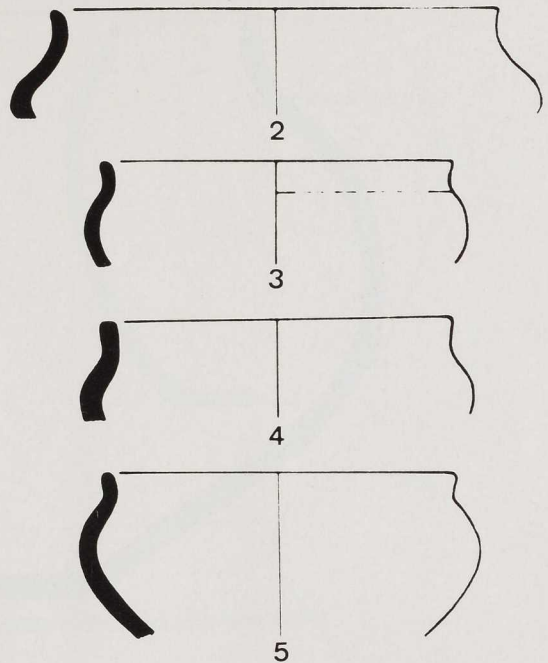

2

3

4

5

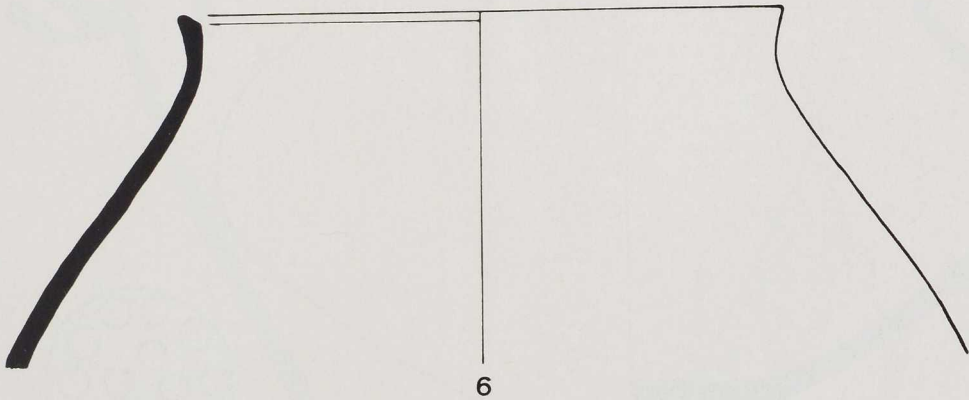

6

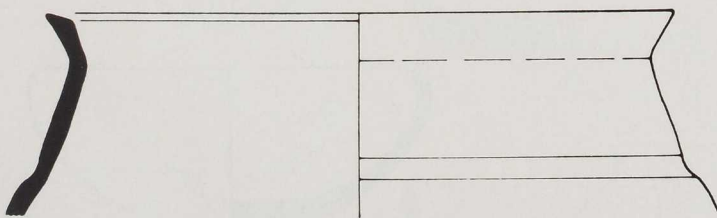

7

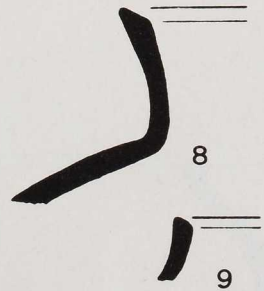

8

9

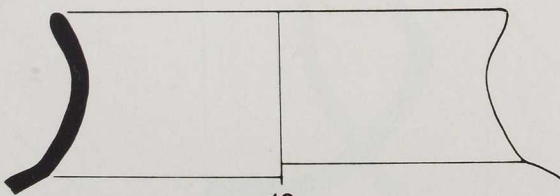

10

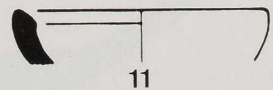

11

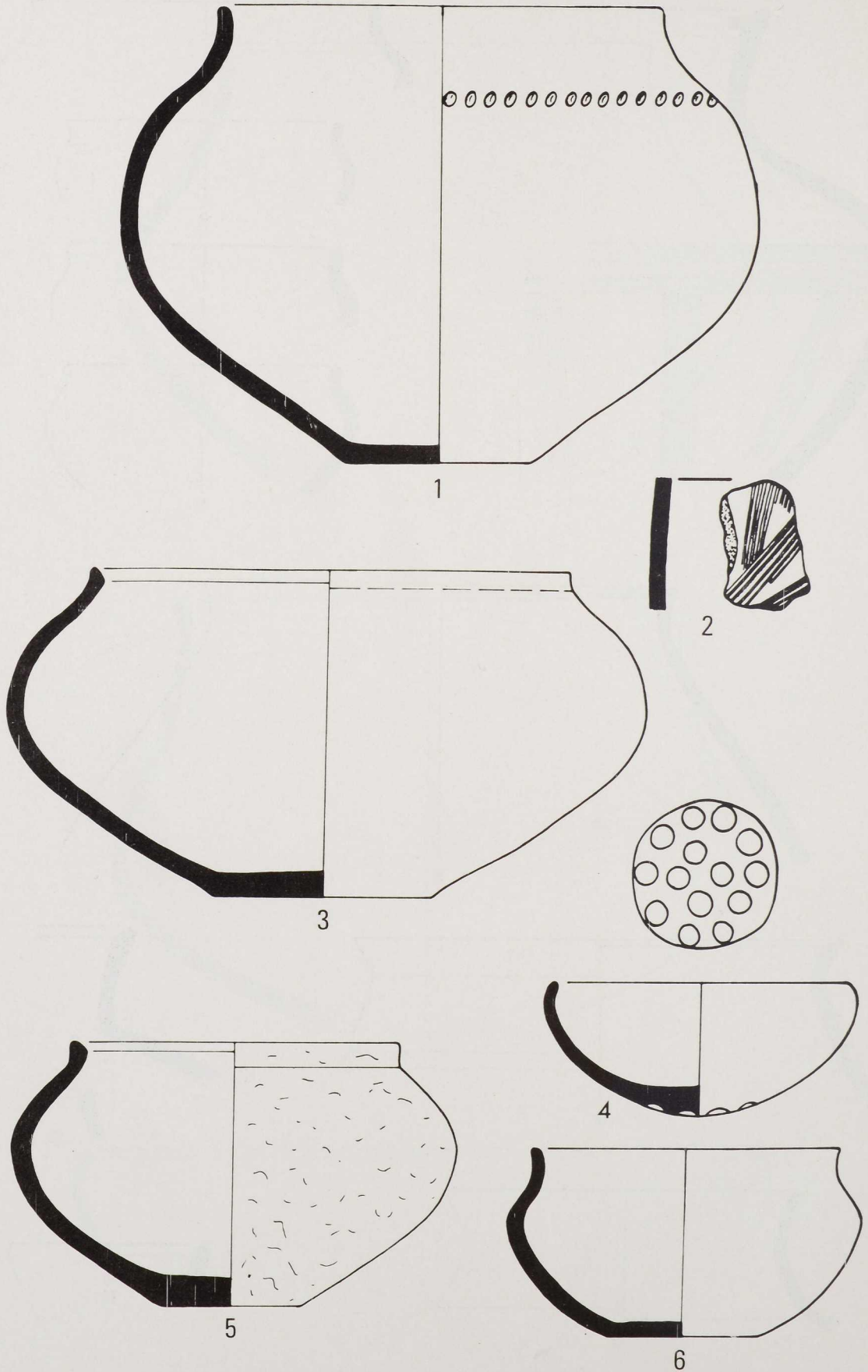

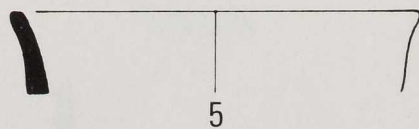
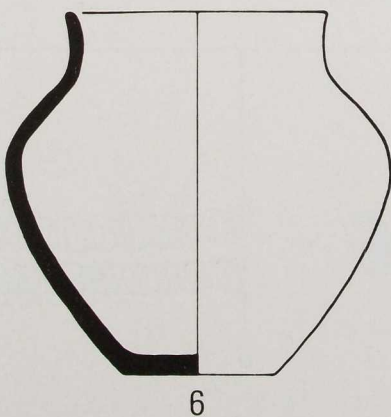
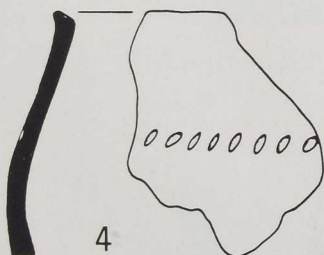
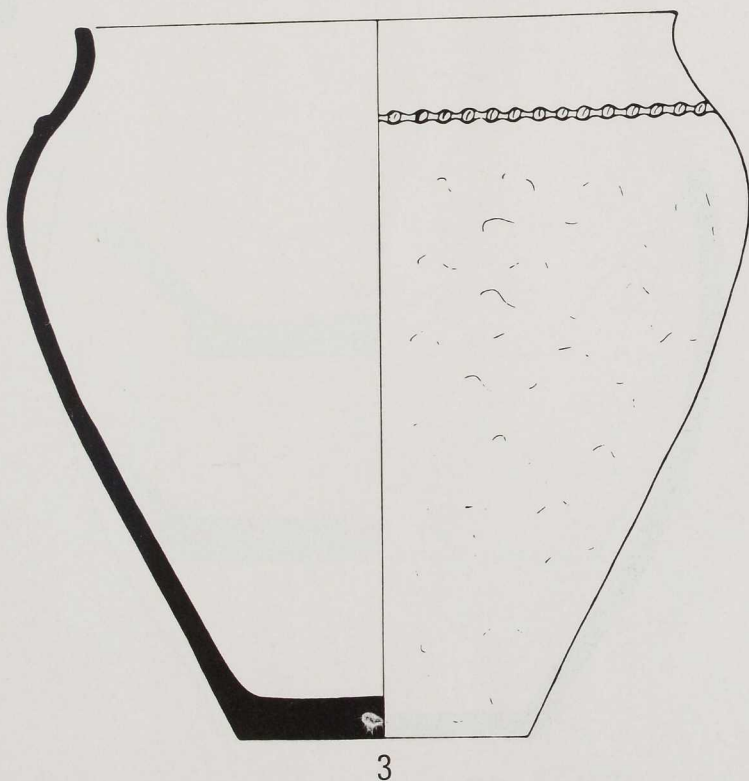
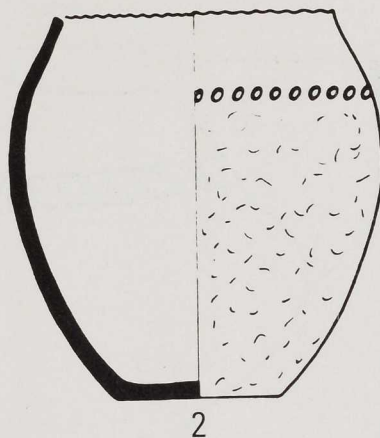
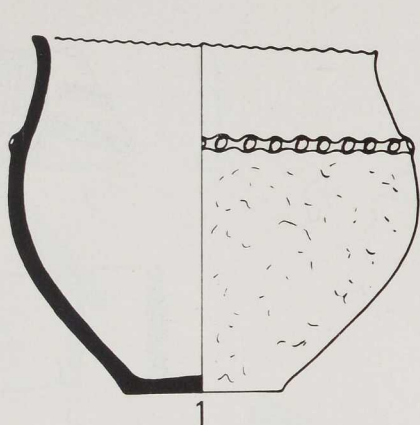

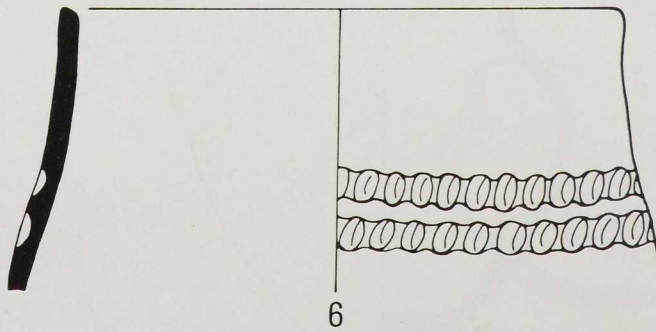
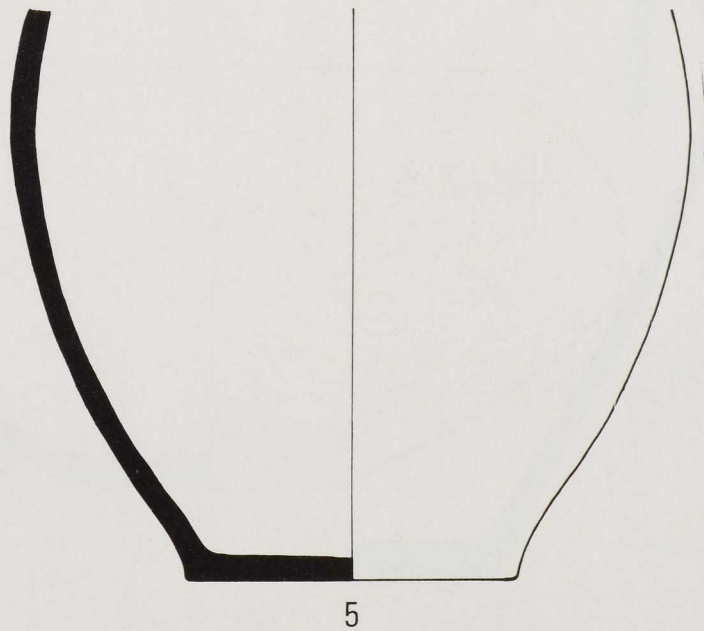
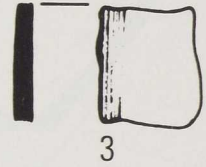
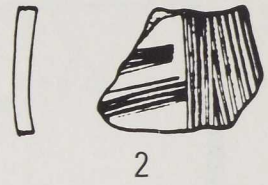
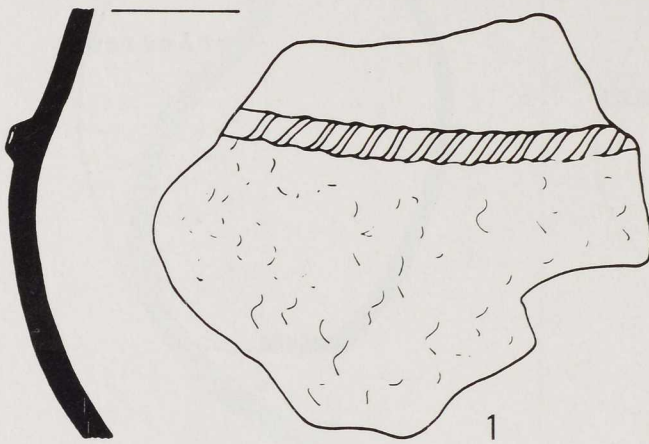



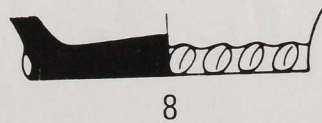
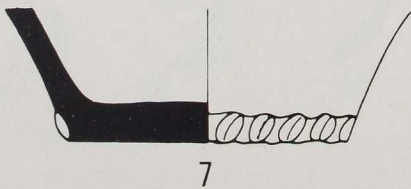
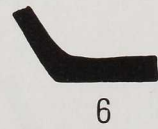
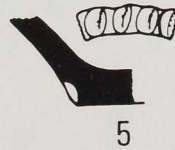
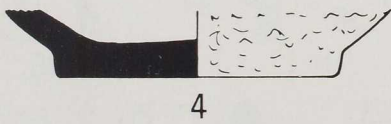
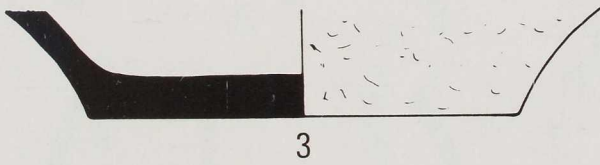
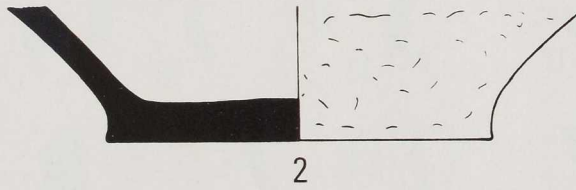
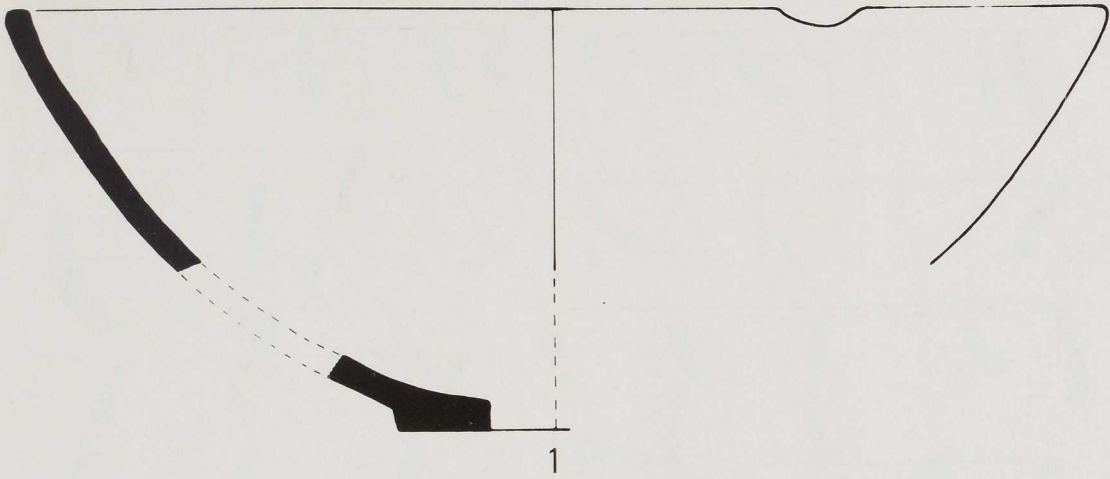

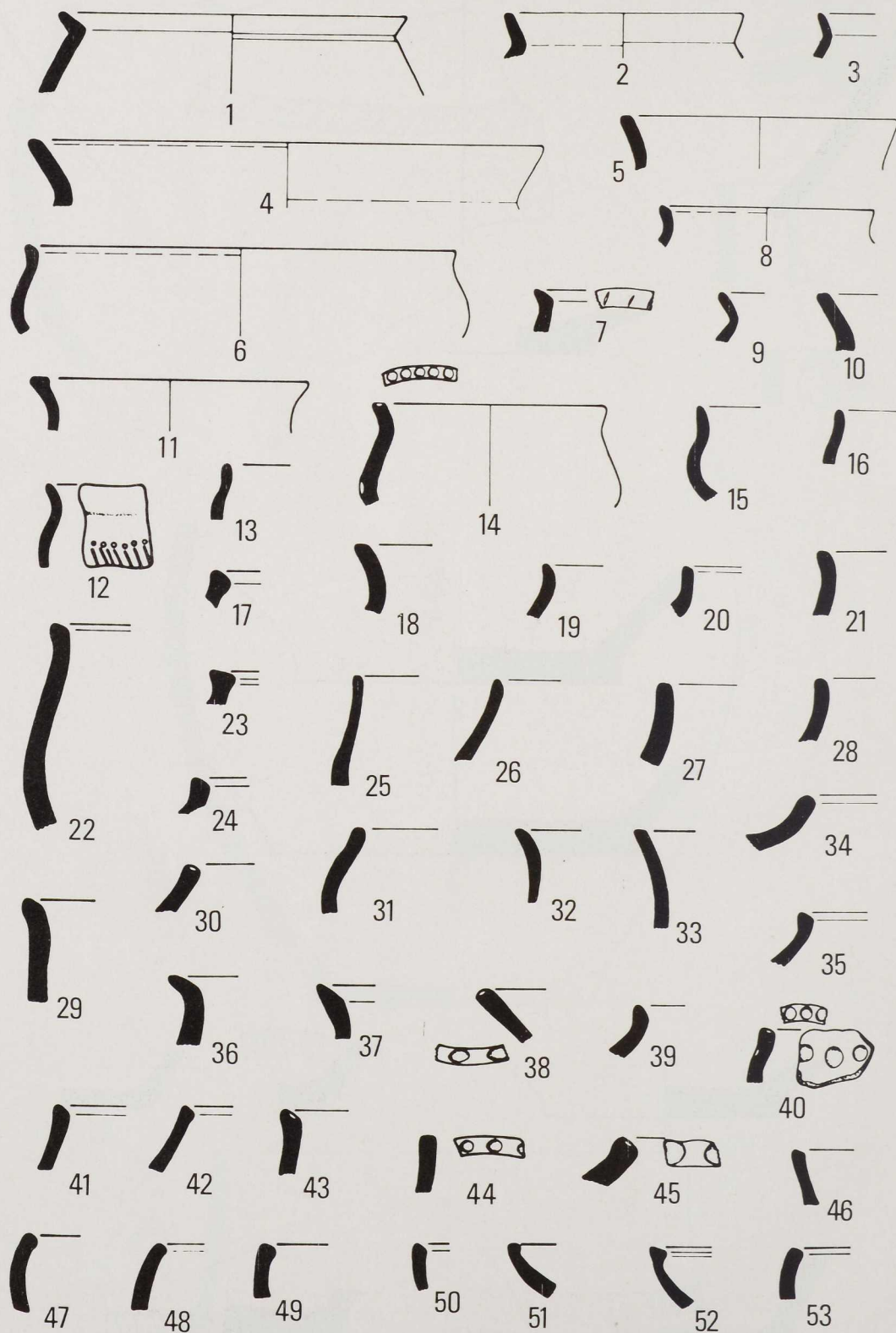

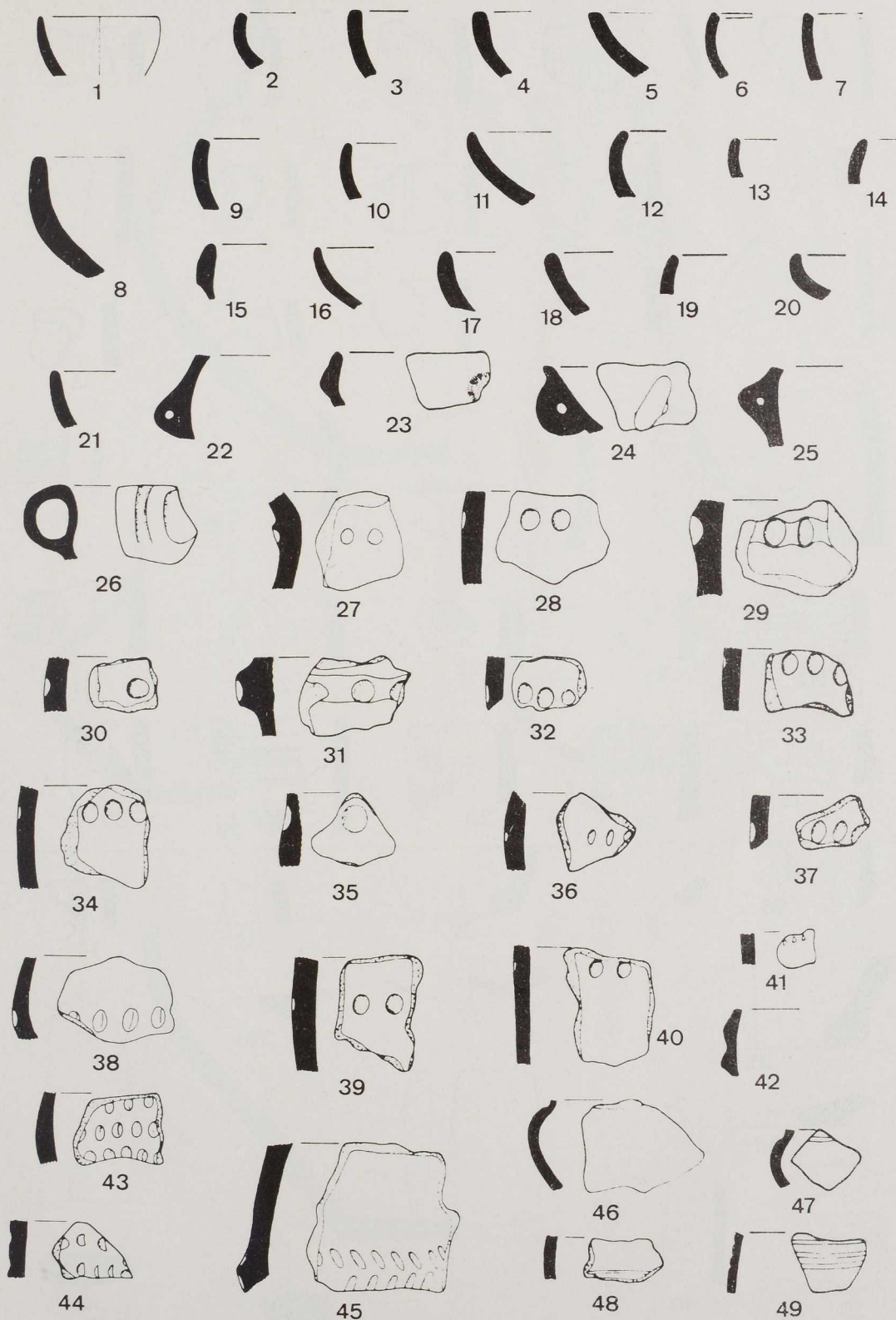

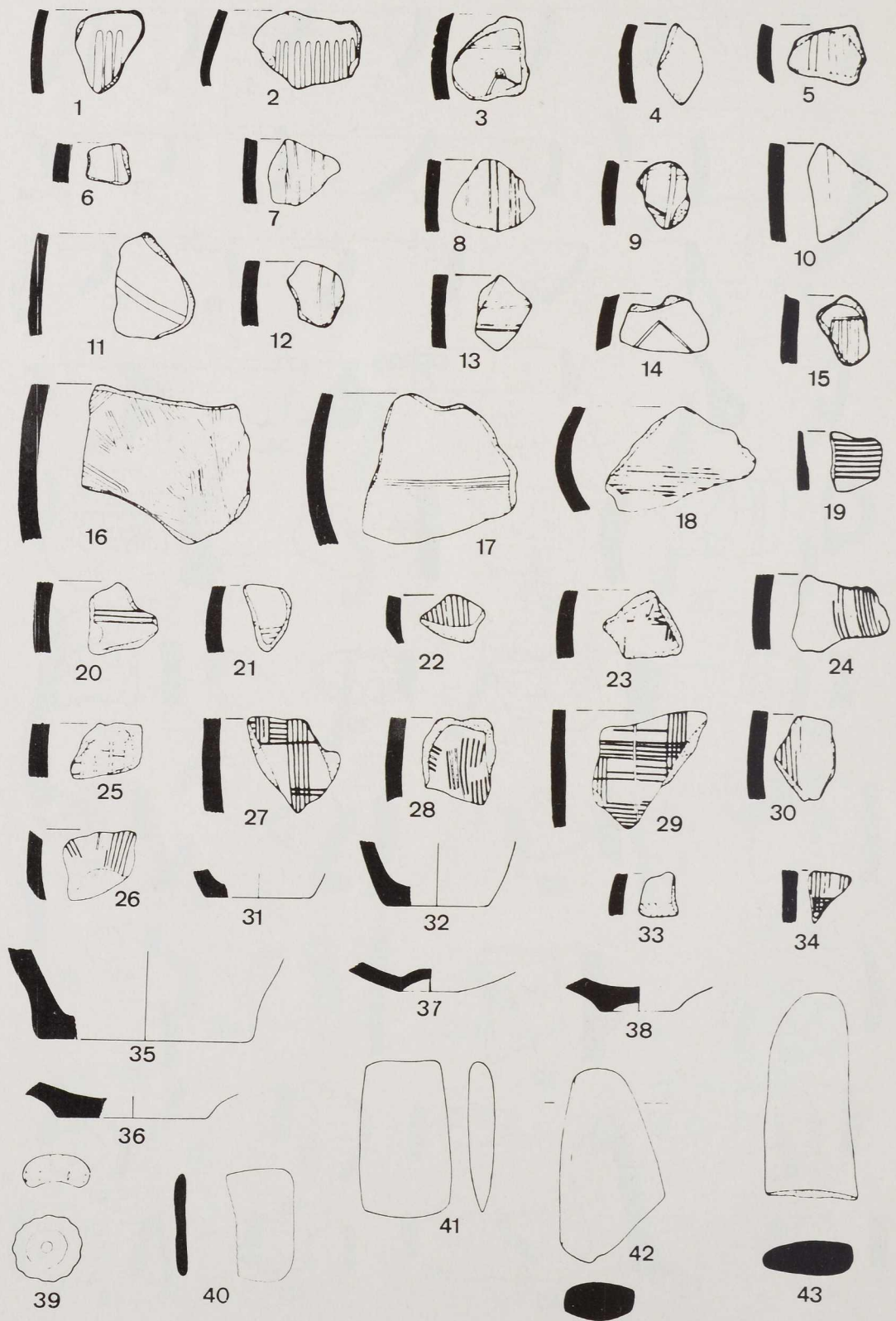

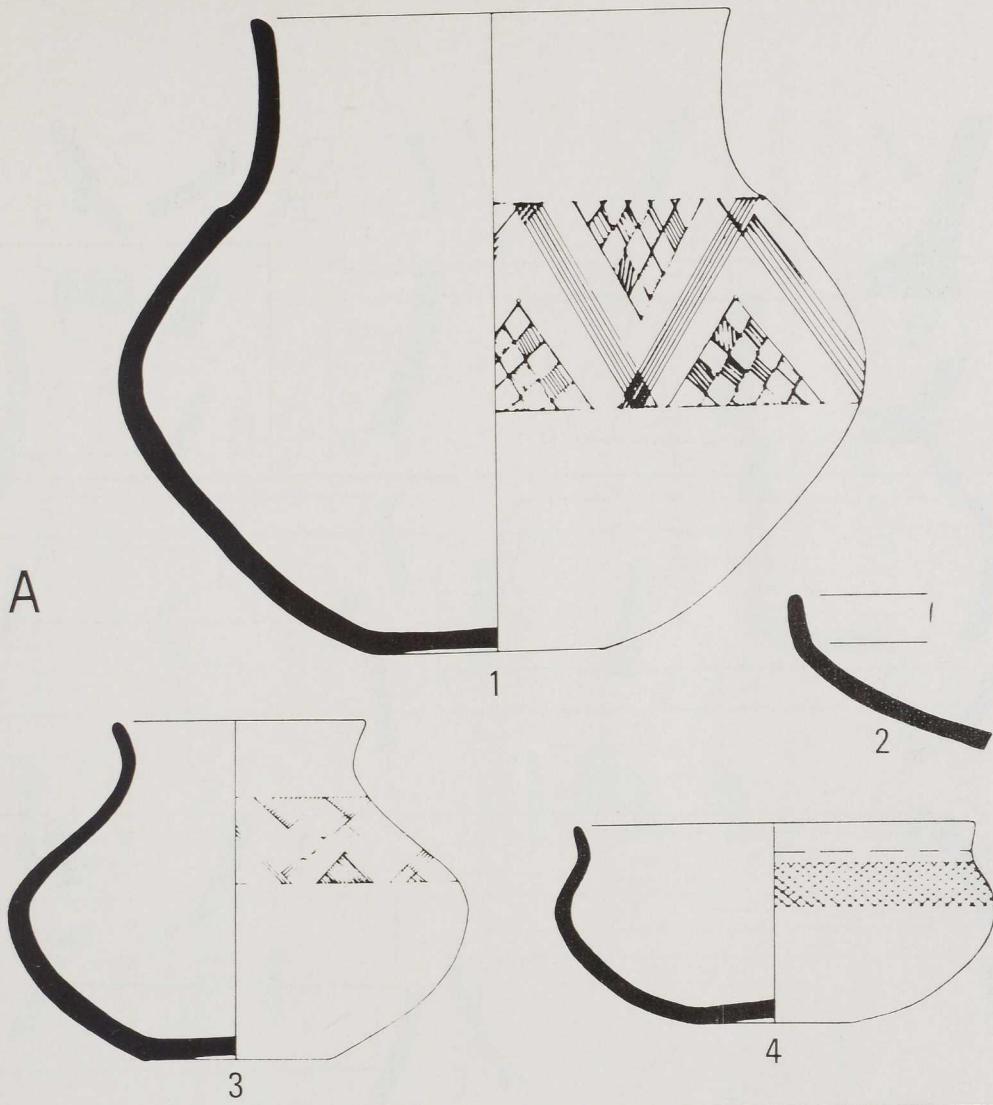

A Langenstein (255). "In der hohen Eich". Grab.  
 B Amöneburg (32). "Lateinschule". Grube. M. 1:3.

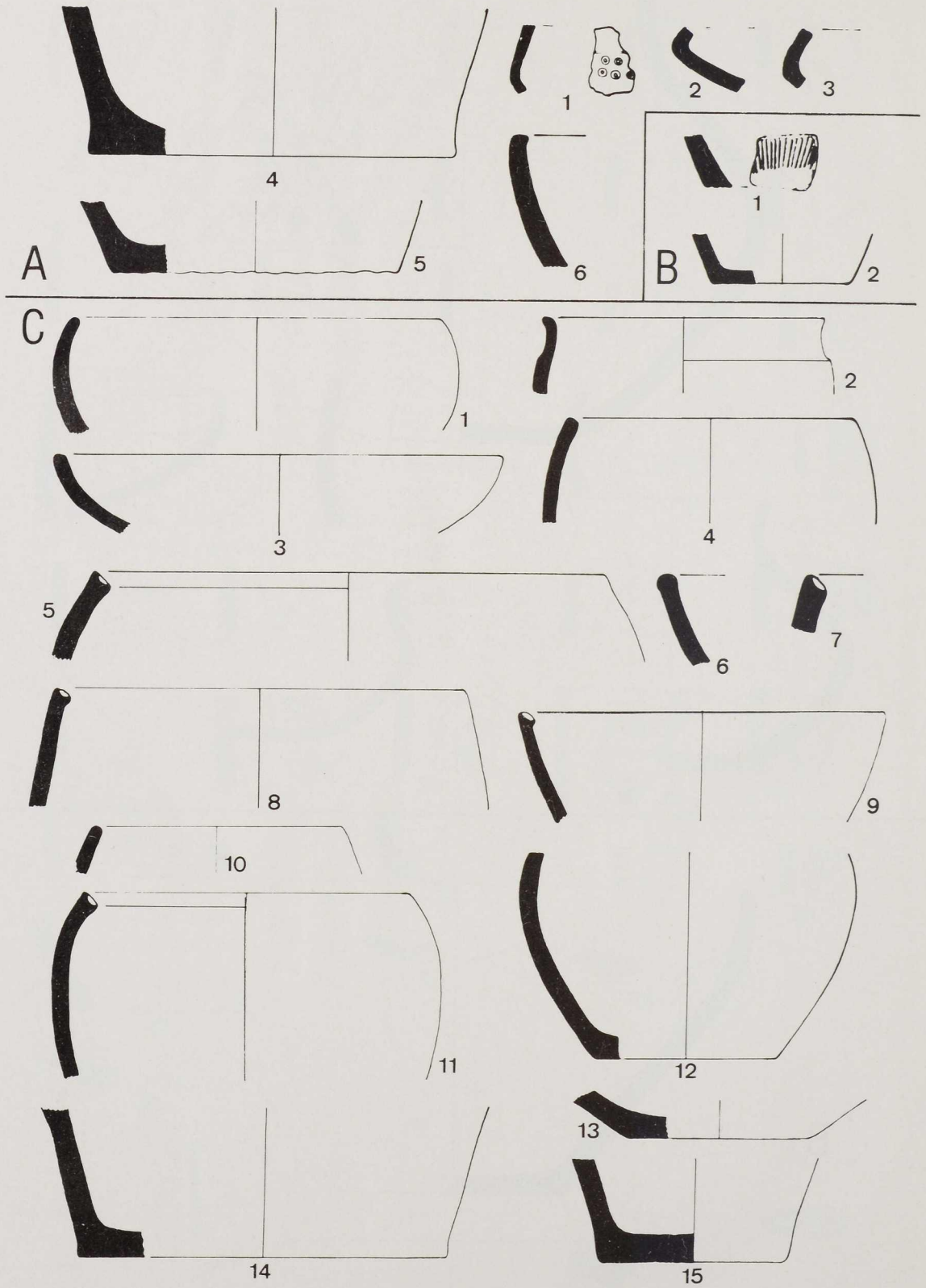

Schröck (398). "Sportplatz". A Grube 1. B Grube 3. C Grube 2. M. 1:3.

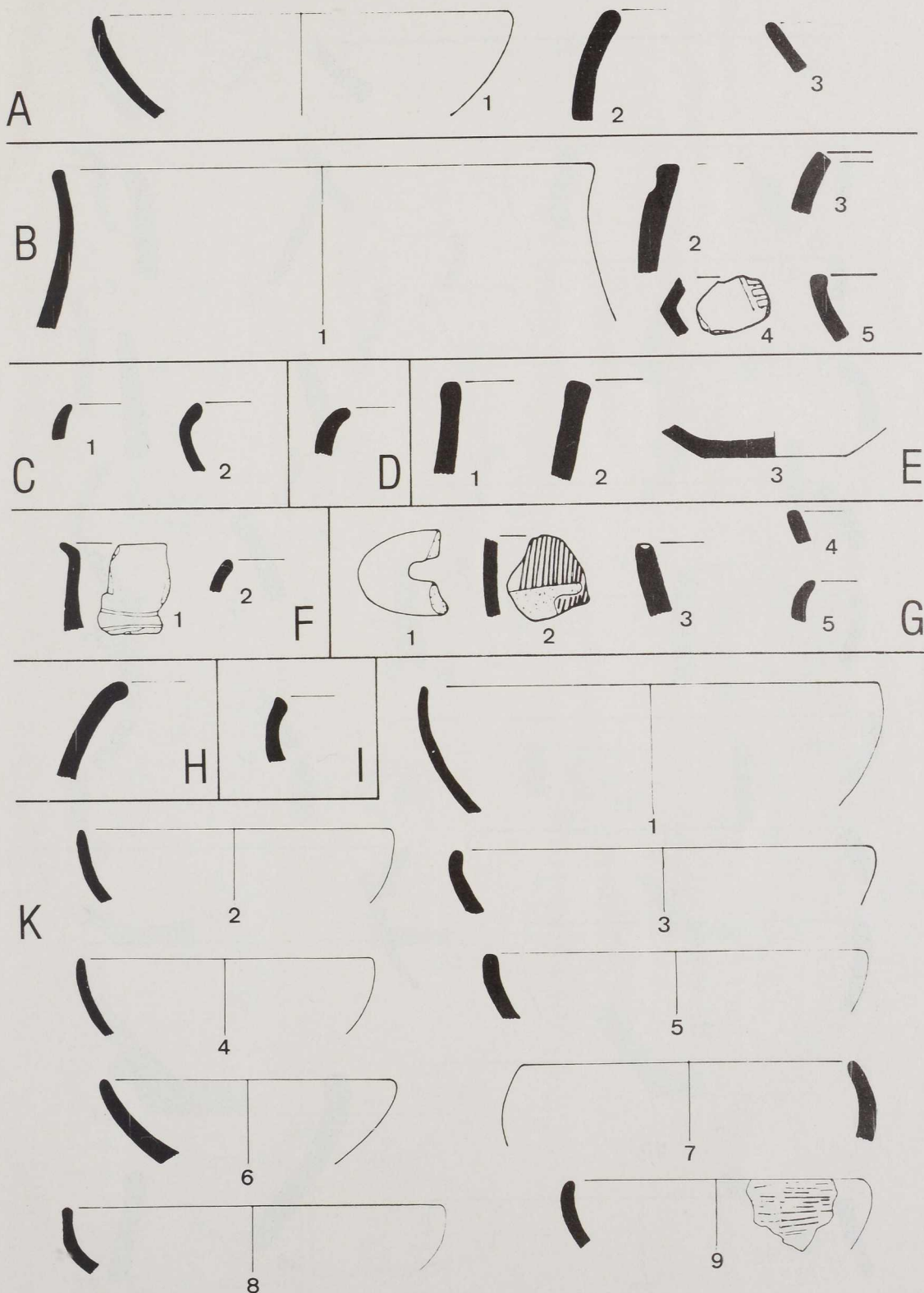

Schröck (398). "Sportplatz". A Grube 4. B Grube 5. C Grube 6. D Grube 10. E Pfosten 6. F Pfosten 11. G Pfosten 12. H Pfosten 15. I Pfosten 24. K Oberflächenfunde. M. 1:3.

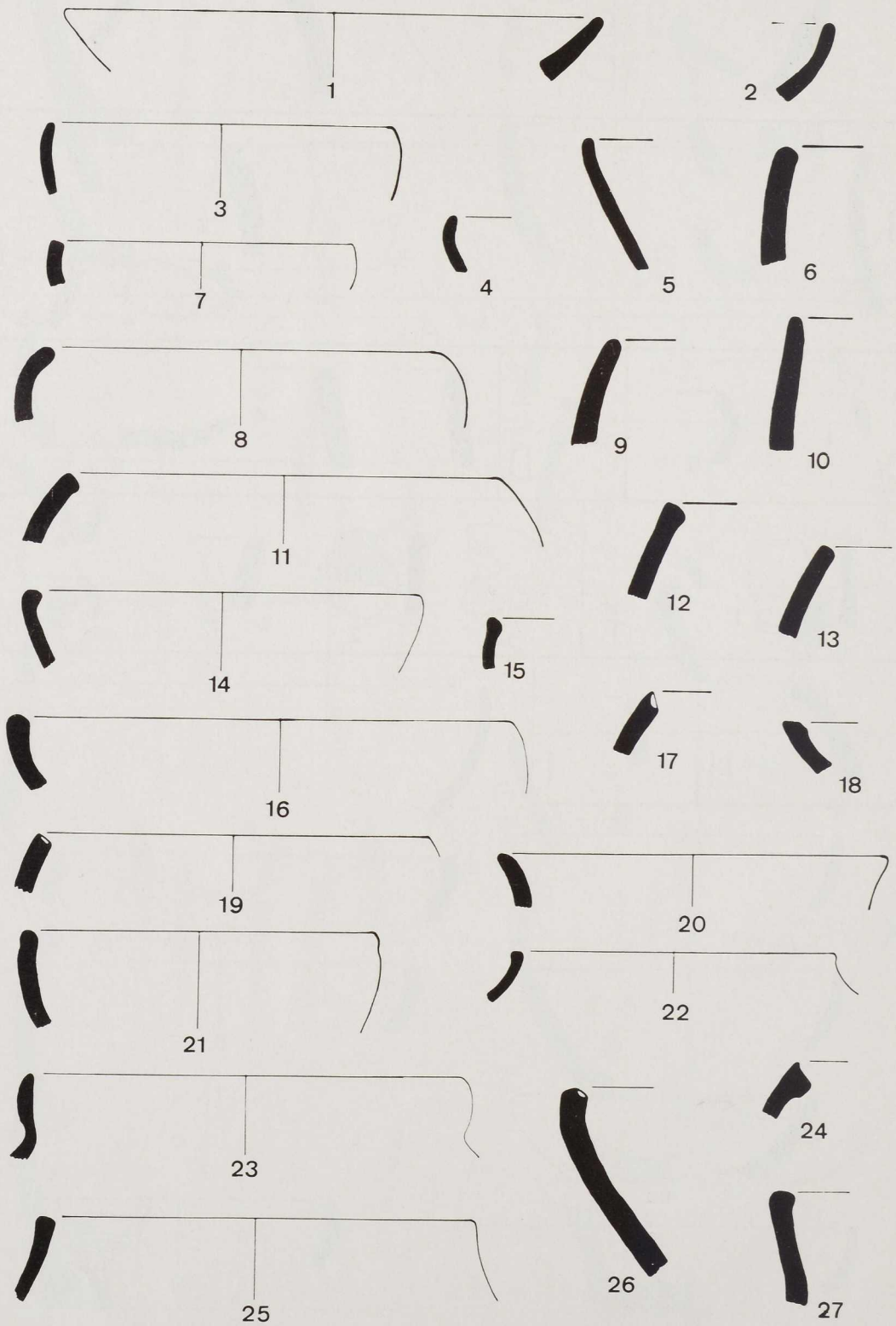



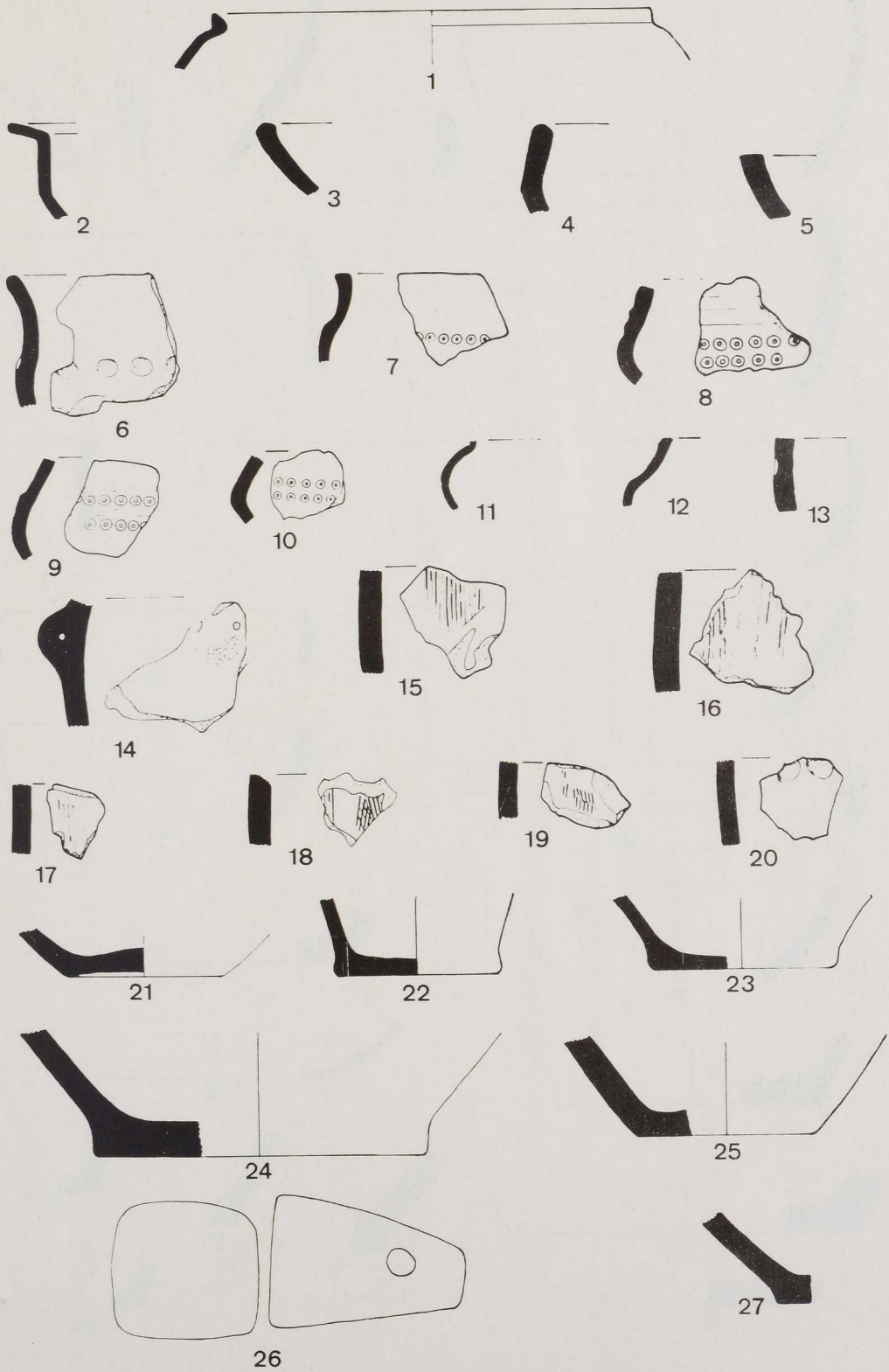

Univ.-Bibl.  
Bamberg

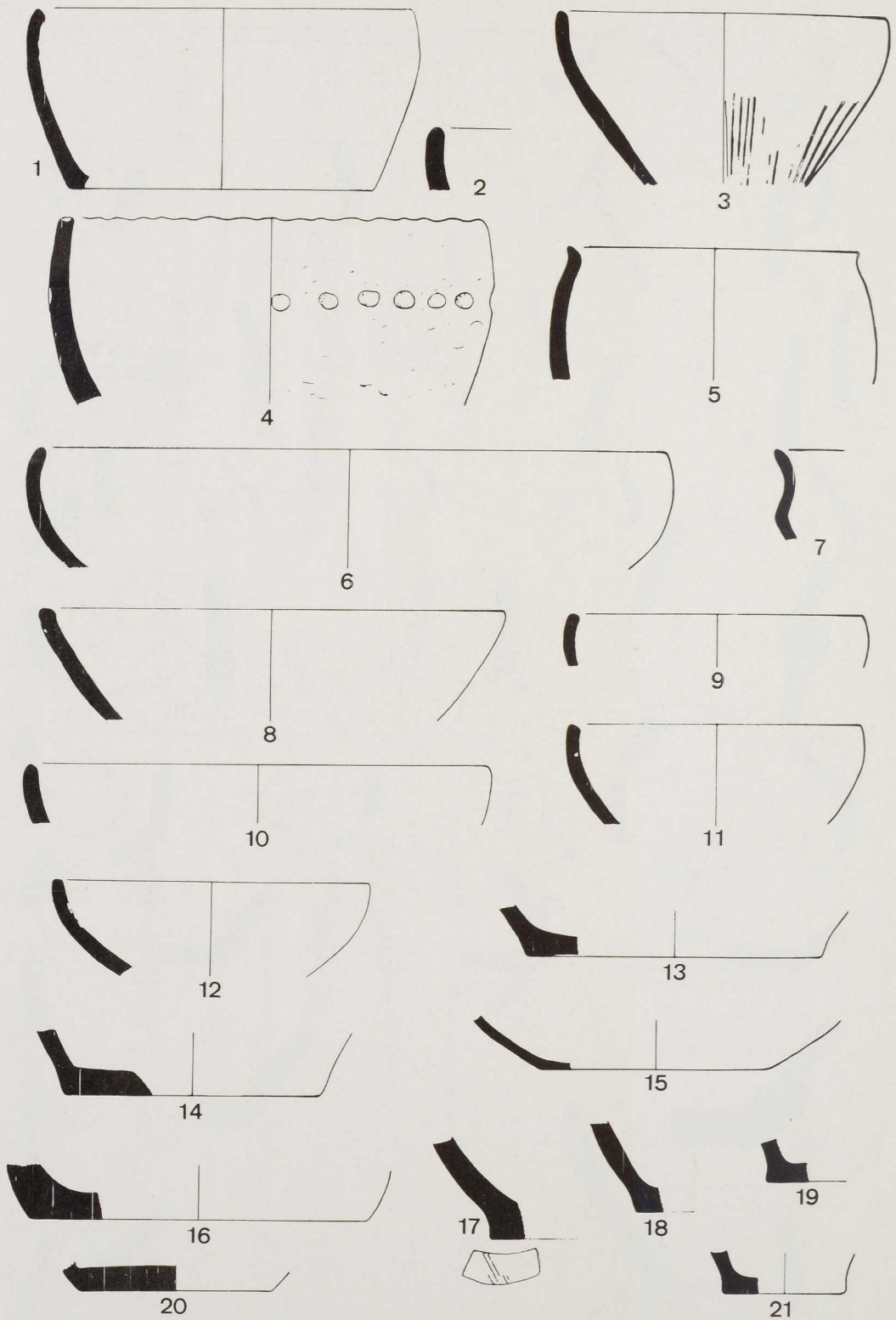

Univ.-Bibl.  
Bamberg